

EMC countermeasures for High-Speed Differential Interfaces

How Do Common Mode Filters Suppress EMI in Differential Transmission Circuits?

TDK Corporation Application Center
Masao Umemura

1 | High-Speed Interfaces

In addition to computers, other home information appliances have also become more advanced, and internet connections are now available for AV equipment, so interfaces that can handle digital information with low signal deterioration have become more important.

This will explain methods for EMC countermeasures on high-speed interface signals, which have become more common for computers and information appliances.

Common High-Speed Interfaces

USB: USB is used for connecting computers with peripheral devices (such as CD-ROMs, scanners, printers, and DSCs) (Figure 1). In 2000, the USB 2.0 standard was implemented, which made three transfer speeds available; LS (1.5 Mbps), FS (12 Mbps), and HS (480 Mbps), which allows for DSC image data to be transferred at high speeds (Photo 1).

Figure 1 USB and IEEE1394 Equipment Used

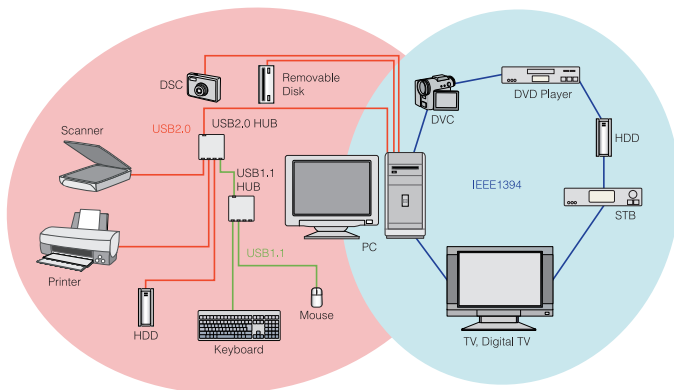

Digital audio devices use USB as the standard interface for transferring audio files from computers downloaded from the internet.

Recently, video contents can also be viewed by mobile devices in addition to audio files, making it necessary to have faster transfer speeds.

In 2008, "USB 3.0" was released, allowing for a transfer speed of 5 Gbps based on the demand mentioned above. There is a demand for distributing large-size video contents, so this new standard has potential to be more common on mobile phones and digital audio devices in addition to computers. Therefore, this interface merits close attention.

Photo 1 What is USB?

- USB, which stands for Universal Serial Bus, is an interface for connecting computers with peripheral devices.
- USB cables contain four lines; Data+ and Data- differential signal lines, and the power and GND lines.
- There are three transfer speeds available; USB 1.1, LS (Low Speed): 1.5 Mbps, FS (Full Speed): 12 Mbps, and with version 2.0, HS (High Speed): 480 Mbps was added.
- Connection requires a host computer.
- The number of ports can be expanded using HUBs, and a maximum of 127 devices can be connected.

USB Connector



Series A



Series B

USB Receptacle



Series A



Series B

Photo 2 What is IEEE?

- IEEE is an interface for connecting computers with peripheral devices and AV devices.
- IEEE contains six lines including two differential signal lines which are TPA and TPB, and the power / GND line (There is a 4-pin connector without the power / GND line).
- There are three transfer speeds; S100: 100 Mbps, S200: 200 Mbps, and S400: 400 Mbps. However, 1394.b will support 800 Mbps or higher.
- Generally, a host is not necessary, and it can be used for connection between devices.
- A maximum of 63 devices can be used for one bus.

IEEE1394 Connectors



6-pin type



4-pin type

IEEE1394 Receptacles



6-pin type



4-pin type

IEEE1394: IEEE1394 is an interface that was initiated by Apple Computer, which calls it Firewire, and was adopted by the IEEE and has become more common (Figure 1, Photo 2). This is a standard interface for video related devices such as flat panel TVs, DVD recorders, and DVCs with practical use speeds ranging from 100 to 800 Mbps.

The roadmap for the IEEE interface has been set to achieve speeds of up to 3.2 Gbps, so higher speed communication will be available in the future. With few exceptions, IEEE does not require the concept of a HOST. High-speed transferring and recording of MPEG signals between AV devices is possible using simple remote control operation. The directional movement for this interface is half duplex.

DVI / HDMI: DVI and HDMI interfaces are used for sending digitized image signals output from a computer to a monitor, which used to be done using analog RGB data. These interfaces allow for uncompressed digital video signals to be transferred at high speeds. The TMDS method is used and the maximum speed is 1.65 Gbps, with the transfer frequency generally reaching 850 MHz. With DVI, only video signals can be transferred (Figure 2).

Figure 2 DVI Interface (Panel Link) Usage Example

* DVI: Digital Visual Interface

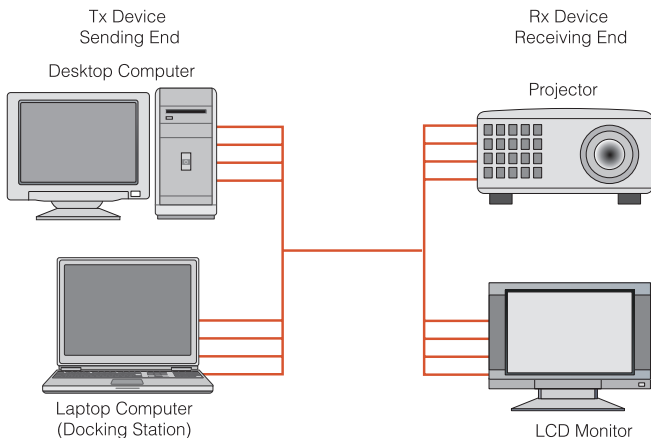

With HDMI, in addition DVI video signals, audio signals can be sent simultaneously when connected to AV devices. HDMI also allows for copyright protection, and in the United States, digital TVs must be equipped with HDMI inputs. This interface has quickly become widespread (Figure 3). The directionality for this interface is one directional from the HOST to the TARGET.

S-ATA: S-ATA is an interface used for computer HDDs which has come to replace the IDE method. Serial ATA is used because of the demand for a high-speed interface to handle large amounts of data (Figure 4). The speed for S-ATA is 3 Gbps, and can be sorted into classes based on the usage purpose, such as for internal connections or external HDDs. There are different voltages used for transferring data. The directionality is half-duplex.

Figure 3 HDMI Interface Usage Example

* HDMI: High Definition Multimedia Interface

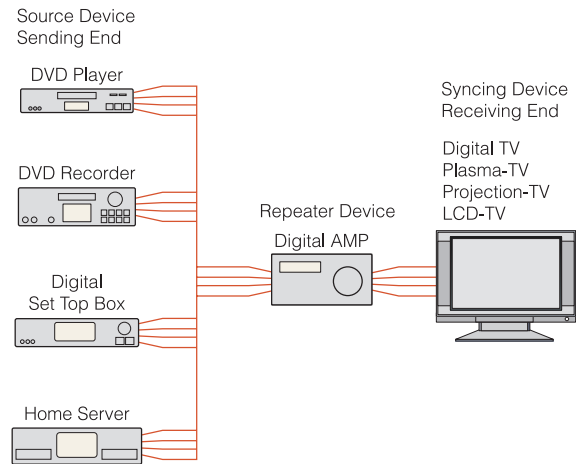
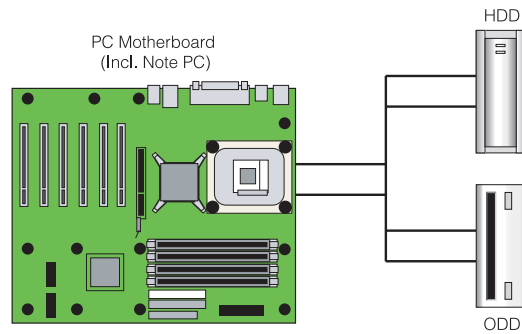

Figure 4 S-ATA (Serial ATA) Usage Example

* S-ATA: Serial AT Attachment



DisplayPort: Whereas HDMI is the standard digital interface for AV device connections, DisplayPort is an interface for connecting computers with monitors. DVI has been used as an interface for connecting computers and monitors, but it seems that this will be replaced by DisplayPort because it is smaller and capable of higher transfer speeds.

DisplayPort contains four "Lanes" of differential pair line. There are two link rate modes for each lane; 1.62 Gbps (Low bit rate) and 2.7 Gbps (High bit rate). In addition, with DisplayPort, the clock signal is embedded in the data signal, so there is no clock line as with HDMI / LVDS. Therefore, the maximum transfer rate is 10.8 Gbps (2.7 Gbps × 4), making it compatible with resolutions of QXGA (2048 × 1536) and higher.

The standard frequency during 2.7 Gbps transfer is 1.35 GHz, which places it in the GHz range. In the past, most noise problems with high-speed interfaces were related to the band below 1 GHz. However, with DisplayPort, the standard frequency noise spectrum exists in the GHz band, so it is necessary to verify interference problems related to wireless applications.

PCI-Express for internal computer bus connections, and Infiniband for connecting servers, which operate at over 3 Gbps, have also been released as advanced interfaces. It is expected that differential transfer methods will become more common as interfaces capable of transferring signals at higher speeds while minimizing the number of wires (Table 1).

Table 1 Common High-Speed Interface Types and Speeds

| | |
|--------------------|-------------------------------------|
| USB 1.1 / USB 2.0 | 12 Mbps / 480 Mbps |
| IEEE1394.a/b | 400 Mbps / 800 Mbps |
| LVDS | 1.12 Gbps: UXGA |
| Mini-LVDS | 1.12 Gbps: UXGA |
| RSDS | 160 Mbps |
| S-ATA I / II / III | 1.5 Gbps / 3 Gbps / 6 Gbps |
| DVI | 1.65 Gbps: UXGA |
| HDMI | 3.4 Gbps: 1080 p / 16 bit gradation |
| DisplayPort | 2.7 Gbps |
| PCI Express (I/II) | 2.5 Gbps / 5 Gbps |
| USB 3.0 | 5 Gbps |

2 | What is Differential Transmission?

Various methods for transferring high-speed signals have been proposed and have come to be used. In order to improve EMC, this section will explain the differential transfer method, which is commonly used for these interfaces.

Figure 5 Differential Signal Unbalanced Components Differential Signal Waveform

(a) Ideal differential signal

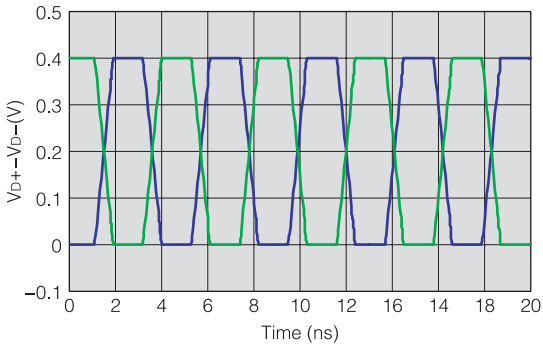

(b) Phase shifting (0.1 nsec.)

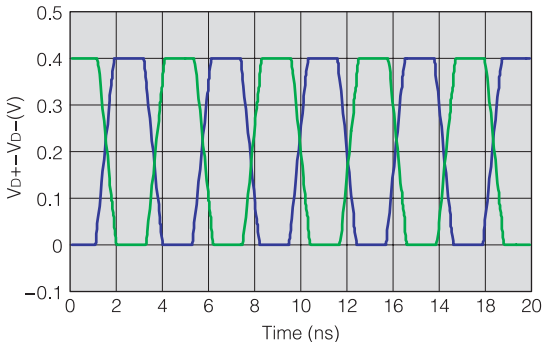

Blowup of (a)

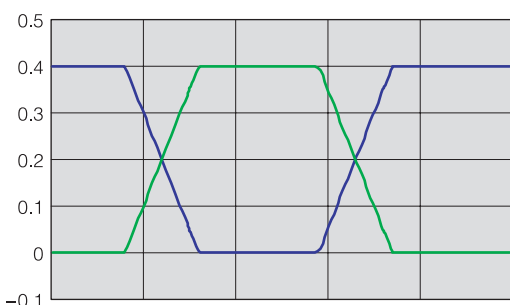

The differential transfer method uses two signals that have 180° opposite phases, which is different from single line data transfer. This transmission method is also referred to as balanced transmission, which has a smaller amount of unnecessary radiation than with the normal single-end transmission method, and also has the characteristic that it is more resistant to influence from other devices. However, in reality, common mode noise is generated due to differential signal unbalance, noise current leaks from other circuits on the substrate to the outside through the connector, and noise is radiated through the cable, which acts like an antenna.

In the above, it was explained that the unbalance of the differential signal causes common mode noise, and this section will explain more details about this unbalance. Figure 5 shows ideal differential transmission and the signal waveform with phase shifting between differential signals. The ideal common mode voltage, which is expressed as the total of the two signals, is linear. However, when the signal has poor symmetry among the channels, unbalanced components are generated. This is referred to as skew.

D+ + D- (Common Mode Voltage)

(a) Ideal differential signal

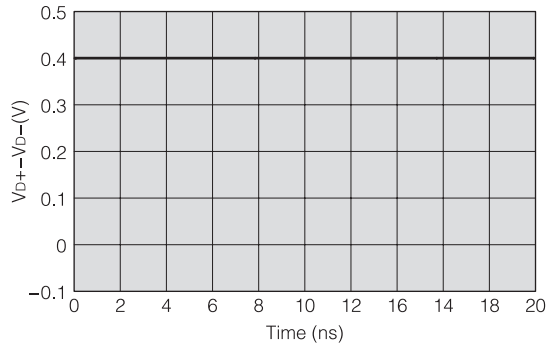

(b) Phase shifting (0.1 nsec.)

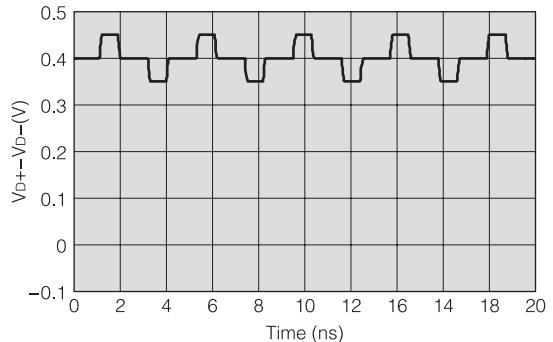

Blowup of (b)

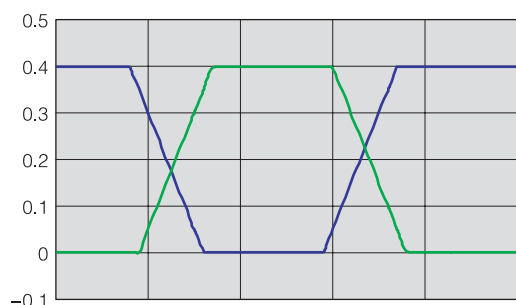

As shown in Figure 6, unbalanced components are also generated by other unbalances such as differences in the rise and fall times and differences in the pulse width and amplitude. Unnecessary common mode radiation increases if the amplitude of the unbalanced components is higher.

Common Mode Filters are components with 1:1 transformer characteristics consisting of coupled coils between two channels. The main purpose of these filters is to suppress common mode current, but they are also effective for correcting differential signal unbalance. When a signal is input to one channel, the same signal is induced to the other channel so that balance can be maintained between both lines.

Figure 6 Other Possible Causes of Unbalance

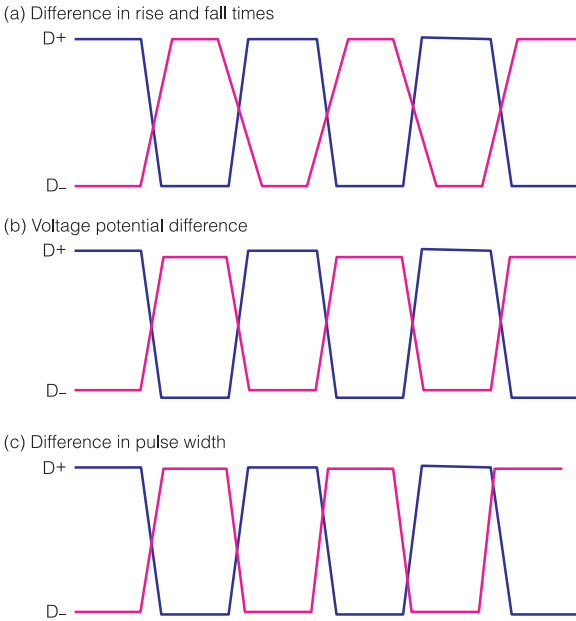

As shown in Figure 7, the input voltages for the two channels are expressed as V_1 and $-V_2$, and the output voltages are expressed as V_{1out} and $-V_{2out}$. The output voltage is the total of aV_1 and $-aV_2$ voltages that pass each channel, and the total of the $-bV_1$ and bV_2 voltages that are induced.

This is shown in the following equations.

$$V_{1out} = aV_1 + bV_2$$

$$V_{2out} = -aV_2 - bV_1$$

The coefficients a and b include the coupling coefficients between the channels, the common mode inductance, and the termination resistance.

This is shown in the following.

Coupling Coefficient: $K = 1$,

When Common Mode Impedance $Z_c \gg$ Termination

Resistance: Z_0 ,

$$a = b = 1/2,$$

$$V_{1out} = -V_{2out} = V_1/2 + V_2/2$$

Therefore, when V_1 and V_2 are different, the absolute values of the absolute voltages are equal.

Figure 8 shows the differential signal waveform for USB 2.0 HS (High Speed) mode. This shows that the unbalanced component of the common mode voltage was corrected by installing a Common Mode Filter. This shows the effectiveness of reducing unnecessary common mode radiation. Based on this result, it can be said that Common Mode Filters are effective components for the EMC countermeasures of differential signal lines.

The differential mode impedance of Common Mode Filters can be reduced in the high-frequency band through magnetic coupling of the channels. Therefore, there is no danger of influencing high-speed differential signal waveform quality. Common Mode Filters with high coupling are better because they have lower differential mode impedance. Details regarding the effectiveness of correcting skew will be explained in Chapter 4 using test results, which will help to show the how Common Mode Filters can be used to reduce EMI.

Figure 7 Advantages of Common Mode Filters

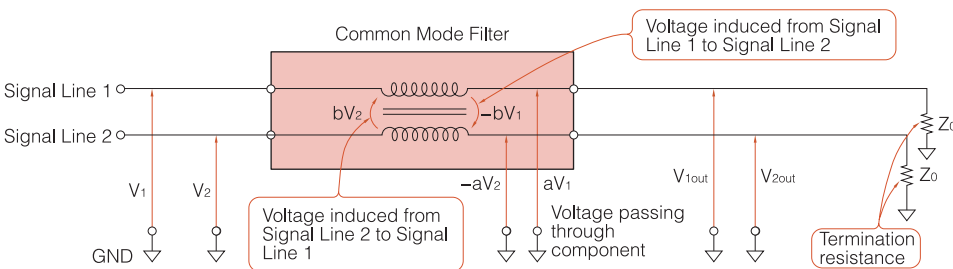
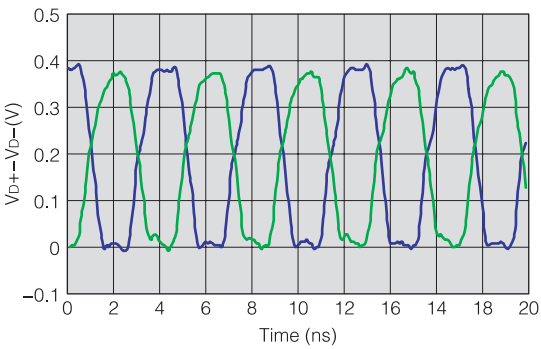
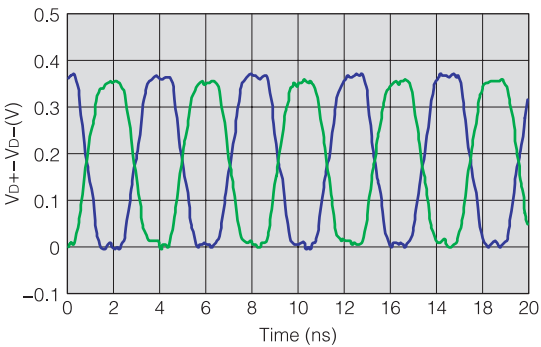

Figure 8 Differential Signal Unbalanced Components
Differential Signal Waveform

(a) USB 2.0 device differential signal



(b) Common Mode Filter Application Example (ACM2012-900-2P)



D+ + D- (Common Mode Voltage)

(a) USB 2.0 device differential signal

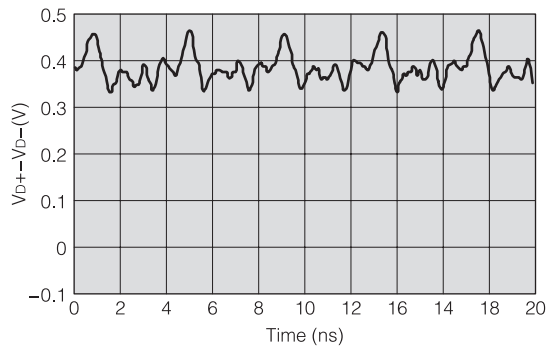

(b) Common Mode Filter Application Example (ACM2012-900-2P)

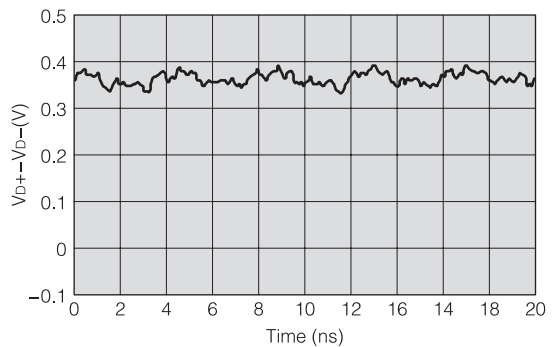

3 EMC Countermeasures for Gigabit Transfer Interfaces

DVI (Digital Visual Interface) and HDMI (High Definition Multimedia Interface) are designed using high-speed TMDS (Transition Minimized Differential Signaling) so that large amounts of information such as HDTV video signals can be sent without being compressed.

These interfaces are often used for multimedia devices such as Digital TVs, computers, DVD players, STBs, DVD recorders. Directionality is not bidirectional, and the circuit configuration is for sending information one-way from the sender

to the receiver. The speed reaches up to 1.6 Gbps, and the basic frequency reaches 800 MHz or higher. This frequency is four to five greater than for USB and IEEE1394, so the details of the requirements for signal quality are regulated (Figure 9).

For this purpose, the following are used.

Eye-patterns

Transmission Line Characteristic Impedance (Cables and Wires on PCBs)

High-frequency (fifth to seventh order of 800 MHz) EMI can occur, so it is important to implement countermeasures for high-frequency EMI.

Figure 9 HDMI Interface Connection Diagram

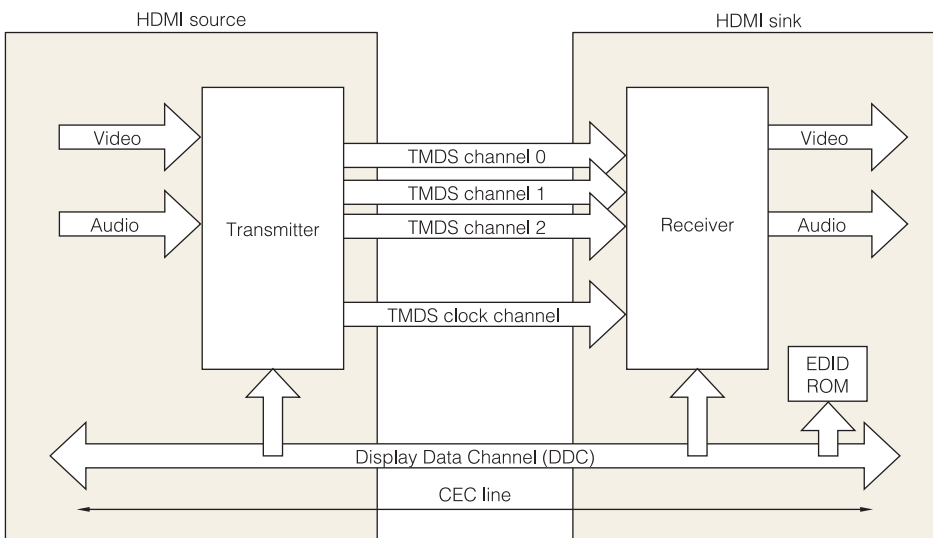

This section will explain the characteristics of newly developed Common Mode Filters for DVI, HDMI, and DisplayPort, their influence on the signal, and their effectiveness for EMI suppression.

1) Common mode filters for HDMI and DVI with 6 GHz cutoff frequency and for DisplayPort with 8 GHz cutoff frequency

Common Mode Filters are used to suppress EMI by installing them to interfaces that handle Gigabit signals. As mentioned in the explanation for USB and IEEE1394, signal quality is strongly affected. Because of this, it is necessary to optimize the cutoff frequency for each interface based on the insertion loss of the differential mode. As a result, it is possible to transfer high-speed TMDS signals without causing strain. With digital signal transmission, transmission is at least five times (fifth order harmonics) that of the fundamental wave so that signal quality can be maintained during transmission.

When Common Mode Filters (ACM-H and TCM-H Series) are used for HDMI, 6 GHz cutoff frequency allows for fifth order harmonics of 2.225 Gbps (about 1.1 GHz) to pass through sufficiently at the 1080p Deep Color transfer rate, which means

the HDMI signal quality can be maintained. The cutoff frequency of Common Mode Filters for DisplayPort (TCM-U Series) was extended up to 8 GHz so that there is no signal deterioration of 2.7 Gps signals (Figure 10 and Figure 11).

2) Eye-pattern

With HDMI, the Eye-pattern is regulated, so if the signal contains strain, it cannot pass the standard. Common Mode Filters for HDMI help to ensure the 6 GHz bandwidth so that products can easily pass the Eye-pattern test. Figure 12 shows the measurement conditions, and Figure 13 (a) shows the measurement results for DVI.

Similarly, the Eye-pattern is also regulated for DisplayPort. When a TCM1210U Series component for DisplayPort is used, the 2.7 Gbps signal does not deteriorate. Figure 13 (b) shows the eye diagram for the sending baseplate. Figure 13 (c) shows the eye diagram for a 10 m cable. The Common Mode Filter did not cause deterioration on the eye diagram with a 10 m cable, which indicates that TCM1210U can be used to reduce noise while maintaining signal quality.

Figure 10 Common Mode Filter for HDMI that Ensures the 6 GHz Band

When the cutoff frequency of the insertion loss of the differential signal is expanded to 6 GHz



Possible to use it for faster differential signal interfaces

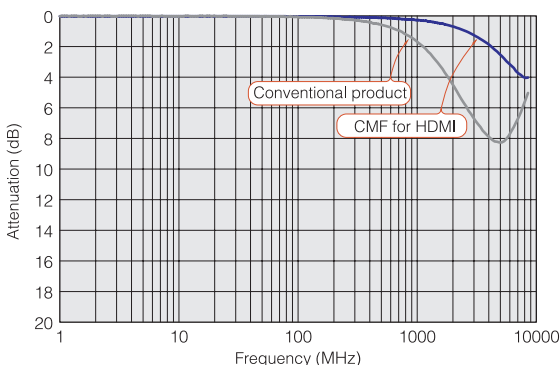

Figure 11 High-band, High-Quality Winding Type CMF

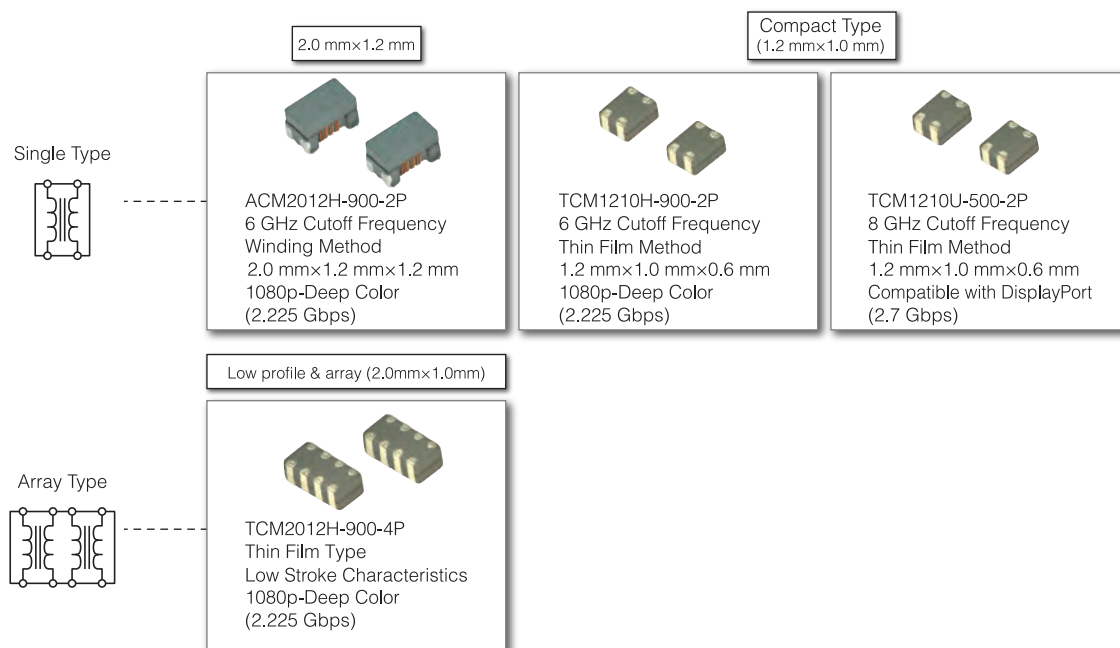

Figure 12 DVI (UXGA: 1.65 Gbps) Waveform Measurement Conditions

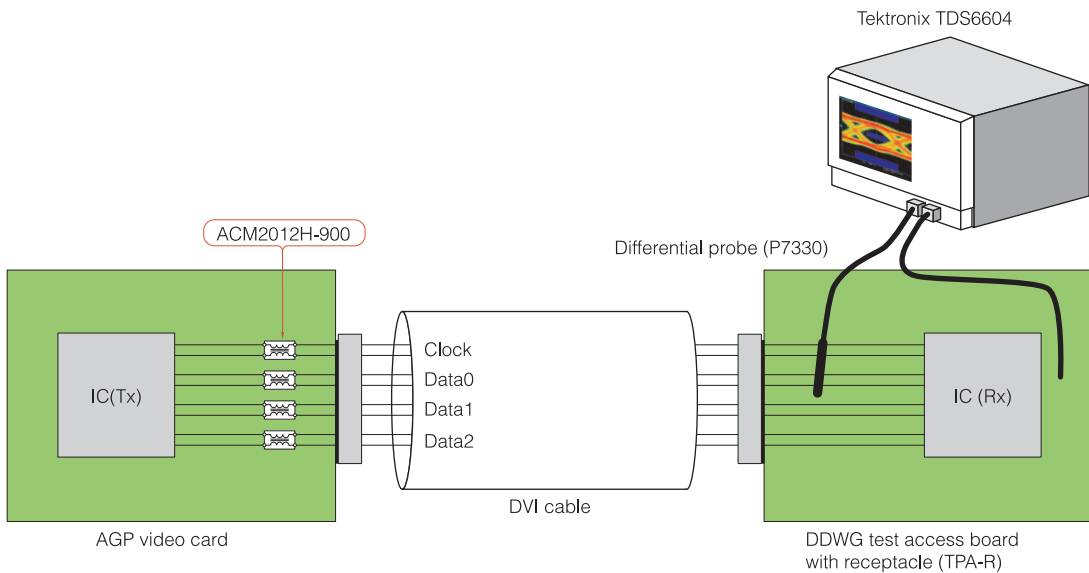
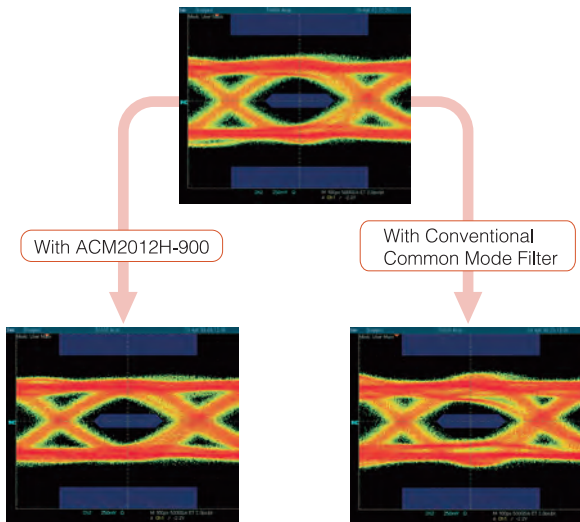
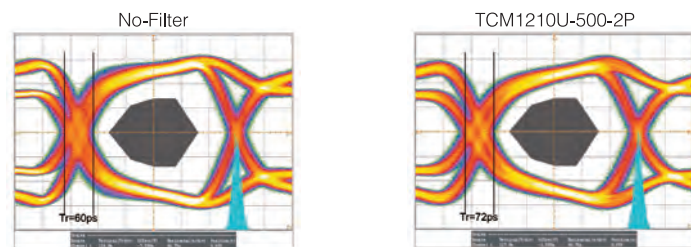

Figure 13
(a) HDMI waveform



(b) DisplayPort waveform at the sending baseplate
(2.7 Gbps during transmission)



(c) DisplayPort waveform at receiving baseplate using 10m cable
(2.7 Gbps during transmission)



3) Characteristic Impedance

HDMI standards regulate TDR (Time Domain Reflectometry) characteristics. This regulates the characteristic impedance for the transmission line so that high-speed signals can be transmitted. The characteristic impedance for PCB patterns equipped with ICs, cables mainly used for transmission lines, and connectors for connections are set at $100 \pm 15 \Omega$. If a Common Mode Filter not recommended for TMDS (or for DVI and HDMI) is used on a TMDS line to suppress EMI, the product will not meet this regulation. For HDMI, the test conditions for regulating connectability will not be met (Compliance tests for HDMI are regulated so that connectability can be guaranteed. If this test is not passed, a product cannot be approved for as an HDMI device.). Common Mode Filters for HDMI are design so that the characteristic impedance between the lines is 100Ω , which means they can be used safely (Figure 14).

Figure 14

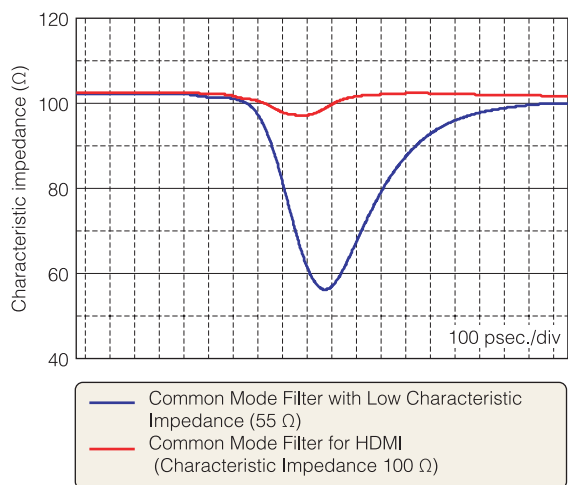

4) EMI Measurement Examples

Figure 15 shows an efficiency example of EMI suppression for HDMI. Figure 16 shows a sample circuit using one of our Common Mode Filters.

Figure 15 Effectiveness of EMI Suppression for HDMI Devices Using an HDMI Filter

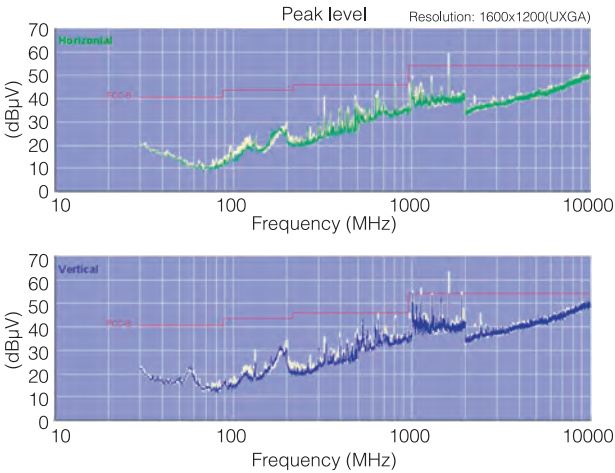
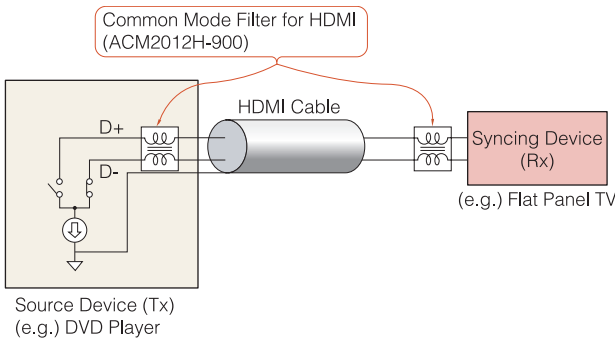

Figure 16 Similar Countermeasures Implemented to a Differential Line with a Total of 4 Pairs: Data Channel (3 Pairs) and Clock Signal (1 Pair)



As with other interfaces, it is necessary to consider noise radiation for DisplayPort. However, computers and monitors are set as the target, so it is also necessary to consider noise interference from wireless devices for computers that use wireless signals such as WLAN and Bluetooth. This noise can be effectively suppressed using Common Mode Filters. Figure 17 shows a measurement diagram for verifying the influence of wireless devices. Figure 18 shows the measurement results. A WLAN device was used for testing. Using IEEE802.11b at 2.4 GHz, it was confirmed that WLAN reception sensitivity differed when noise suppression components were used and when they were not used. By installing a filter, noise was reduced by about 2 to 3 dB.

In the past, noise countermeasures have been implemented to meet FCC and CISPR noise standards. However, from now, it is expected that countermeasures will need to be implemented for electromagnetic noise, which affects the operation of wireless devices.

Figure 17 Verification of the Influence of DisplayPort on WLAN Devices (Measurement Conditions)

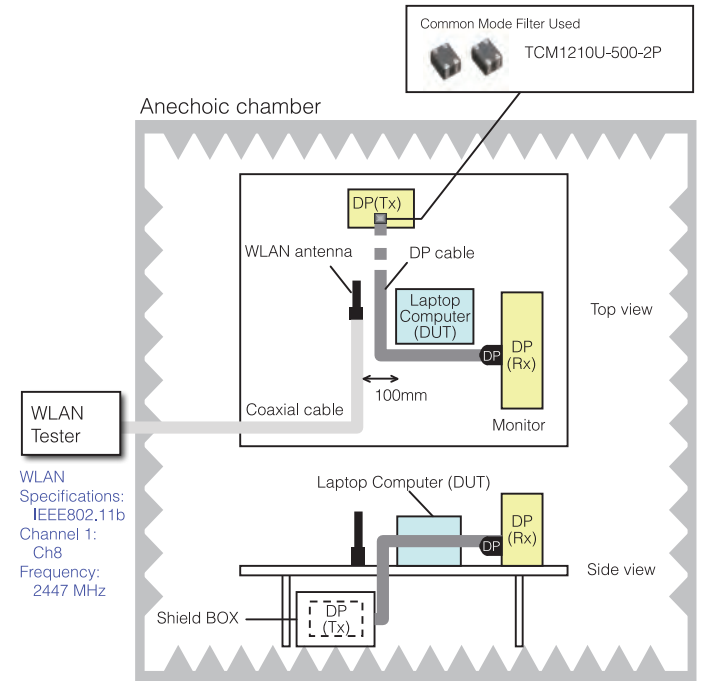

- Verified how much the DisplayPort cable affected the reception sensitivity of a laptop computer with built-in WLAN.
- A graphic board was used as the DisplayPort sending end. A Common Mode Filter was installed at the base of the DisplayPort connector.
- A W-QXGA LCD monitor was used at the receiving end.

Figure 18 Verification of the Influence of DisplayPort on WLAN Devices (Measurement Results)

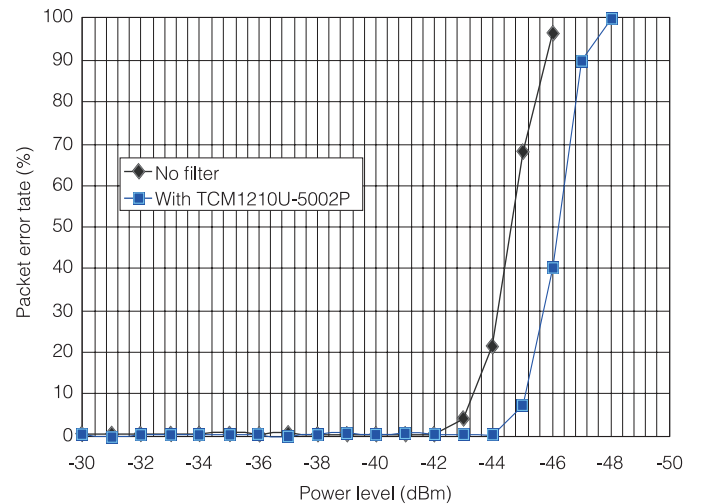

- The expression "No filter" means a short circuit occurred without using a filter. A TCM1210U Common Mode Filter was used.
- The packet error rate of the vertical axis was calculated based on the error packet from the sent packets (1000 packets).
- The horizontal axis indicates the power of the WLAN tester. The filter improved sensitivity by about 2 dB.

4 | How Do Common Mode Filters Suppress Differential Signal Noise?

As mentioned previously, the differential transmission method is used for many devices. The following will explain how Common Mode Filters can be used to suppress differential signal EMI showing basic test results.

A signal generator was used instead of an actual IC in order to simplify the tests, and an accurate signal was used where skew was given to the differential signal, a Common Mode Filter was installed on the differential line, and then efficiency was verified.

IC output itself may already contain skew, and skew may occur during differential signal transmission due to rise and fall characteristic variation. In addition, when the differential signal from the IC is transmitted by the PCB pattern and cables, the difference in the distance to the receiver terminal may be viewed as skew.

Figure 19 Frequency Characteristics Example

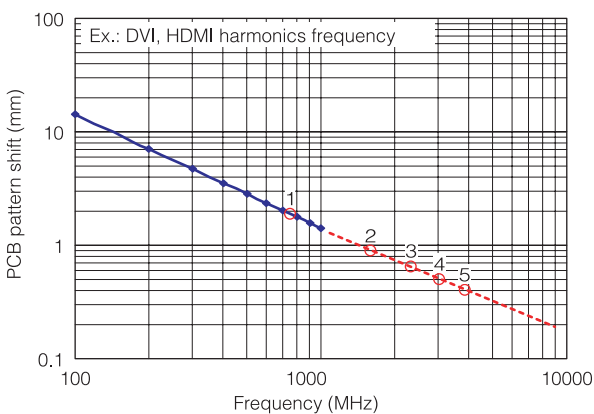

Condition: Calculation was made using a $\epsilon 4.5$ transmission line on a glass epoxy board. The signal transmission speed was 141,323 km/sec. for the $\epsilon 4.5$ glass epoxy board.

Figure 19 is a graph that shows the amount of difference with the PCB pattern can cause skew at the frequency of the differential transmission method that is normally used. The necessary transmission time for skew to occur at 1% at each frequency was calculated. For example, when a signal was transmitted using DVI and HDMI at 800 MHz, the difference in the pattern length was about 2 mm, and skew of about 1% occurred. Therefore, a stricter pattern design is needed for high-order harmonic components.

Figure 20 shows the devices and circuit diagram that were used for testing. A pattern that can receive the differential signal from the signal generator on the baseplate was prepared and then the component was installed. A shielded cable about 1 m long and with a characteristic impedance of 100Ω was installed, and it was terminated at 100Ω . The waveform and EMI was observed by changing the skew from 0 to 3% with a basic frequency set at 100 MHz and amplitude set at 400 mV.

Figure 21-1 shows the waveform when skew was 0%. The throughput was the waveform when no noise components were used. ACM2012-201-2P is a Common Mode Filter often used for USB and IEEE1392 for EMI countermeasures. Measurements were also made when chip beads were used, which are commonly used for EMI countermeasures on signals other than differential signals.

The first waveform in Figure 21-1 is based on the measurement of the differential signal using a single-end probe. The second waveform is the measurement of the common mode voltage with the differential signal added. If a voltage occurs here, noise is radiated as EMI.

The third waveform in Figure 21-1 shows the difference of differential signals, and this waveform is transferred as the input of the receiver terminal IC. The second common mode voltage needs to be given attention.

Figure 21-2 shows when approximately 1% skew is given to the differential signal from the signal generator. A small amount of common mode voltage was observed. However, the voltage amount was according to the order: EMI Components > Chip Beads > Common Mode Filter. The voltage was almost nonexistent when a ACM2012 Common Mode Filter was used.

Figure 20 Diagram of Test Equipment and Circuit

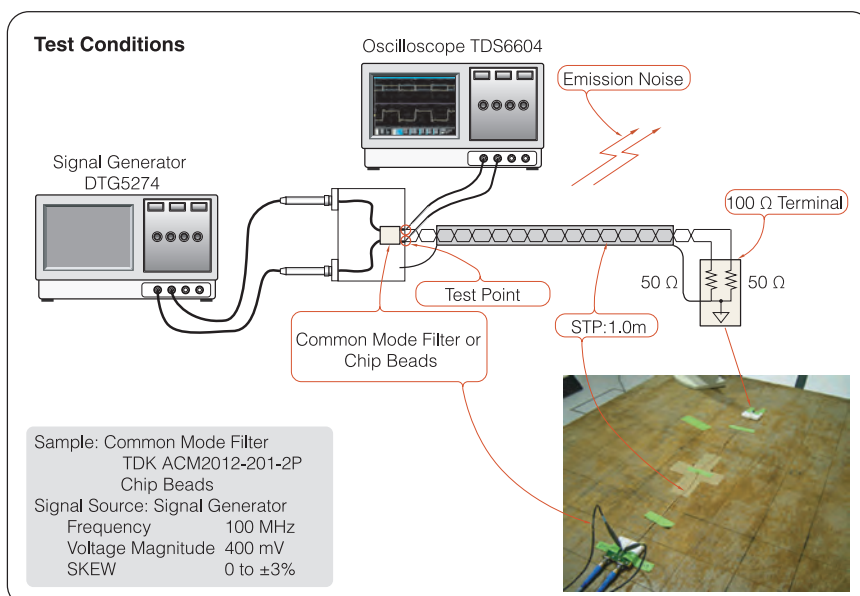

This shows the effectiveness of Common Mode Filters for correcting skew.

Figure 21-3 and Figure 21-4 show the waveforms when the skew amount sent from the signal generator was increased to 2% and 3%. The amount of common mode voltage gradually increased when no EMI components were used and when chip

beads were used. However, when a Common Mode Filter was used, skew was corrected and the voltage was almost nonexistent. Also, when chip beads were used, the differential signal and the voltage magnitude of the signal at the receiver terminal were affected, so it was found that crest value was small.

Figure 21-1 Waveform Data when Skew was Impressed

SKEW: 0%

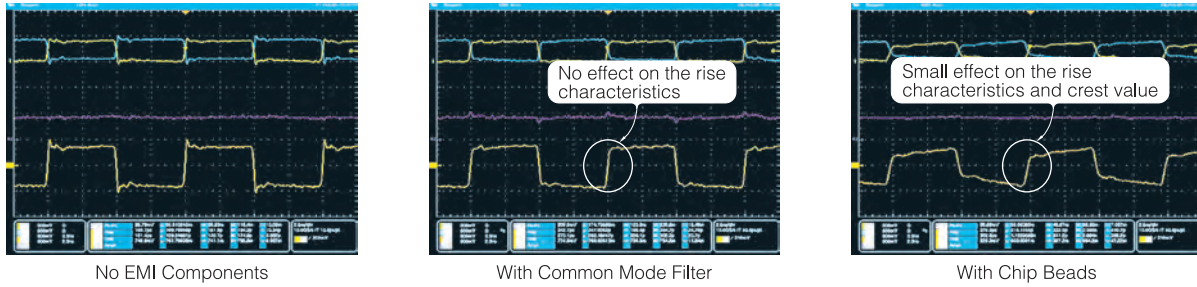

Figure 21-2

SKEW: 1.0%

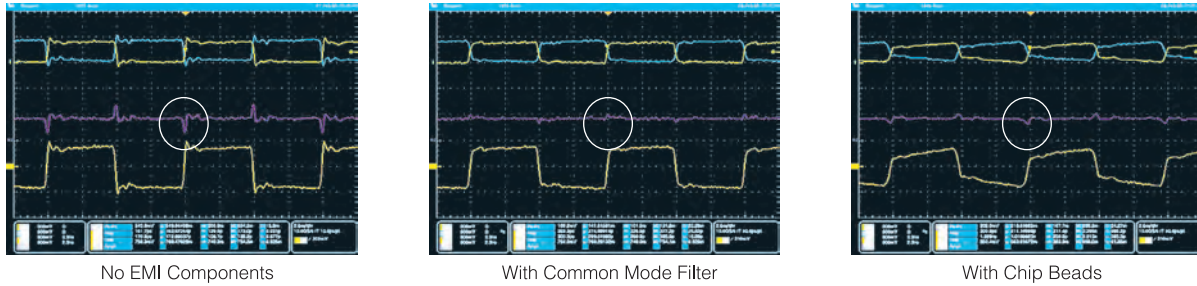

Figure 21-3

SKEW: 2.0%

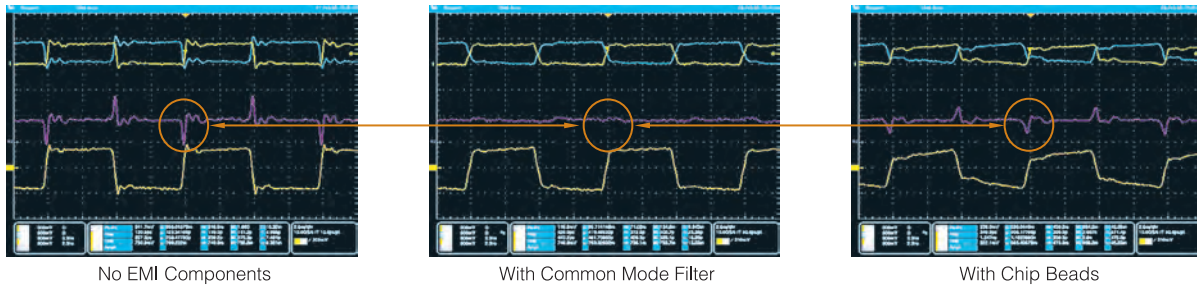

Figure 21-4

SKEW: 3.0%

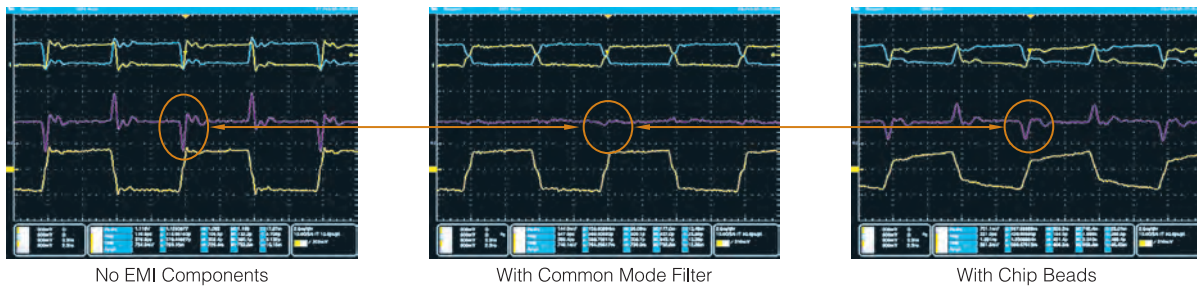

Figure 22 shows a graph with the common mode voltage changes plotted. When a Common Mode Filter is used, the common mode voltage was almost nonexistent even when the skew was large.

Figure 22 Common Mode Voltage due to Skew

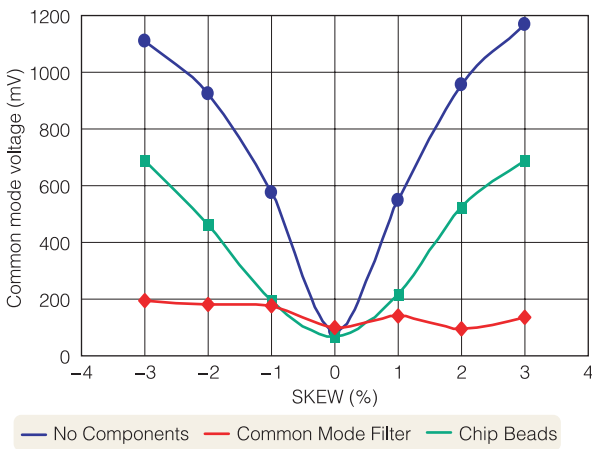

Figure 23 shows the measurement data for EMI radiation characteristics when a 3-m anechoic chamber was used. It was found that Common Mode Filters are very effective at suppressing EMI.

Figure 24 shows a graph plotting the EMI radiation characteristics based on odd-order harmonics including the fundamental wave.

When chip beads were used, the amplitude of the fundamental wave was affected, so EMI occurrence was smaller than when a Common Mode Filter was used at 0%. When a Common Mode Filter was used, it was transmitted without deterioration of the waveform. Therefore, it was lower than when no EMI components were used, but slightly higher radiation characteristics were found than when chip beads were used. Regarding the radiation characteristics from the third to ninth order, the Common Mode Filter was able to reduce EMI radiation up to the harmonics regardless of the amount of skew.

In this way, it was found that Common Mode Filters are able to suppress EMI by effectively correcting skew.

This effectiveness can also be expected when used with actual ICs. Therefore, Common Mode Filters are essential for EMI countermeasures on differential signals, which will continue to become faster.

Figure 25 and Figure 26 show examples of Common Mode Filters.

Figure 23 Effectiveness of Suppressing EMI

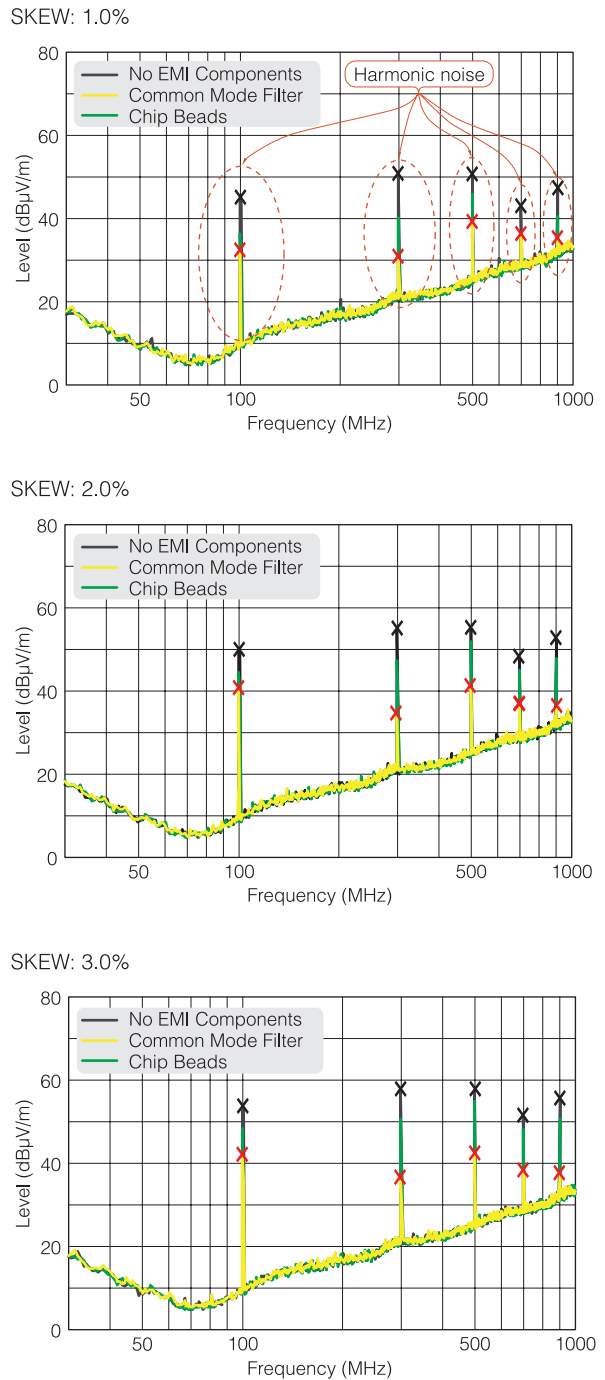

Figure 24 Effectiveness of Suppressing EMI at the Harmonics Spectrum

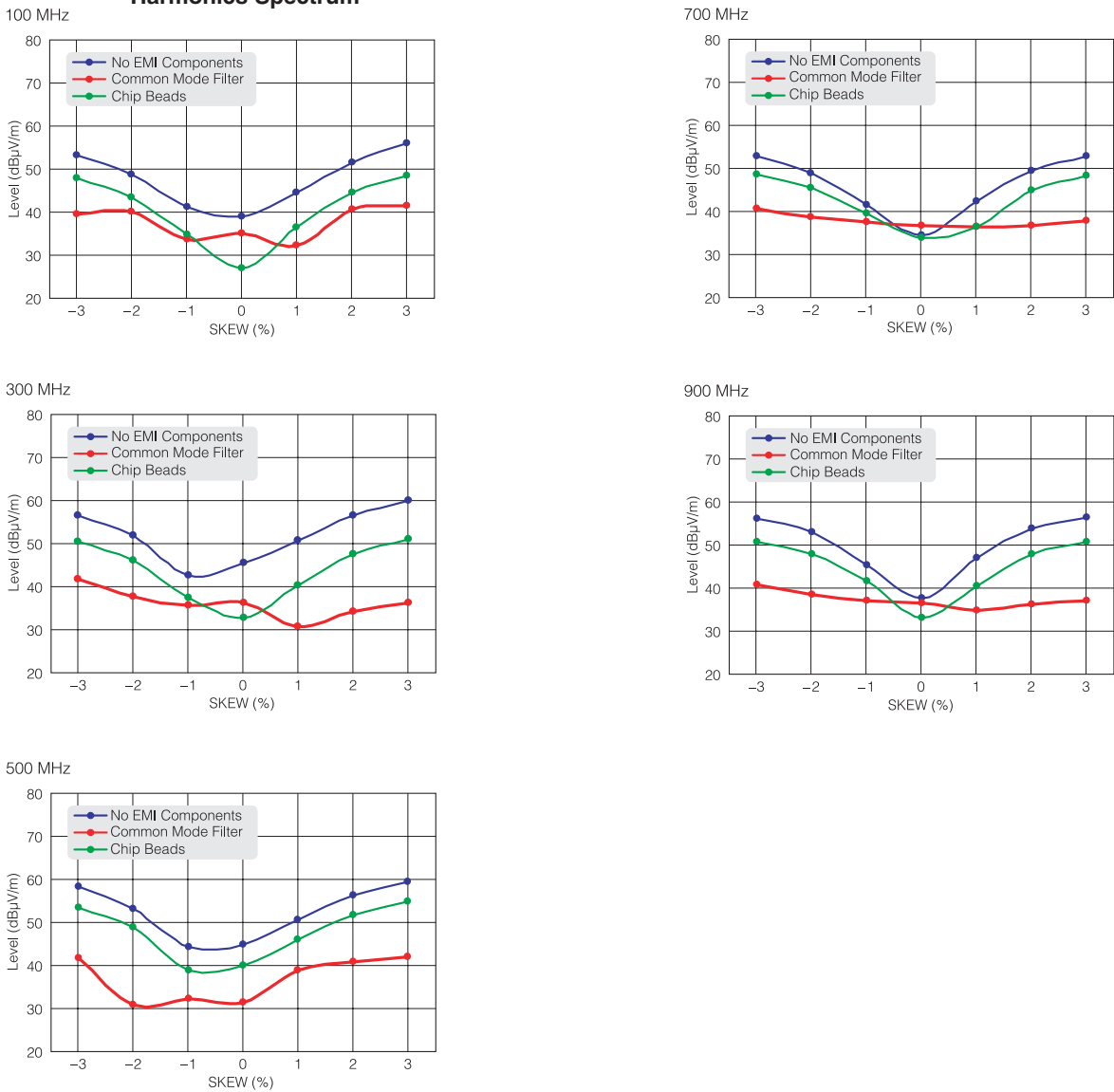
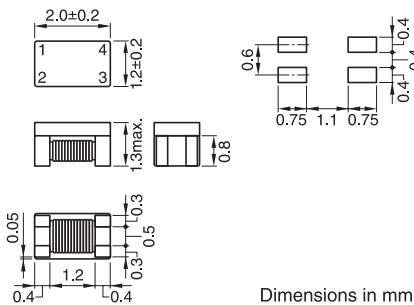

Figure 25 Common Mode Filter Example (1)

ACM2012 Type

Shape / Dimensions and Recommended Land Pattern



Electrical Characteristics

| Part No. | Impedance (Ω) typical [100 MHz] | DC resistance (Ω) max. [For 1 line] | Rated current Idc (A) max. | Rated voltage Edc (V) max. | Insulation resistance (MΩ) min. |
|----------------|---------------------------------|-------------------------------------|----------------------------|----------------------------|---------------------------------|
| ACM2012-900-2P | 90 | 0.19 | 0.4 | 50 | 10 |
| ACM2012-121-2P | 120 | 0.22 | 0.37 | 50 | 10 |
| ACM2012-201-2P | 200 | 0.25 | 0.35 | 50 | 10 |
| ACM2012-361-2P | 360 | 0.5 | 0.22 | 50 | 10 |
| ACM2012-102-2P | 1000 | 1.1 | 0.1 | 50 | 10 |

Figure 26 Common Mode Filter Example (2)

TCM1210 Type

Shape / Dimensions

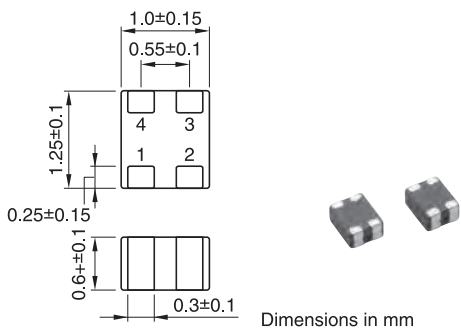

TCM1608 Type

Shape / Dimensions

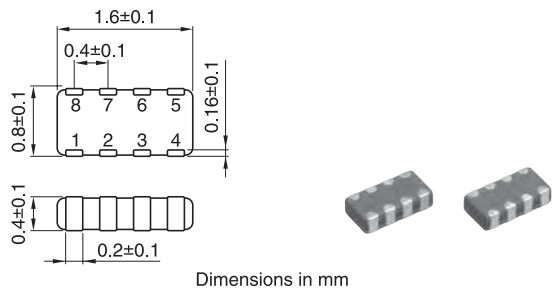

Electrical Characteristics

| Part No. | Impedance (Ω) typical [100 MHz] | DC resistance (Ω) max. | Rated current Idc (A) max. | Rated voltage Edc (V) max. | Insulation resistance (MΩ) min. |
|----------------|---------------------------------|------------------------|----------------------------|----------------------------|---------------------------------|
| TCM1210-650-2P | 65 | 1.5 | 0.1 | 10 | 10 |
| TCM1210-900-2P | 90 | 1.75 | 0.1 | 10 | 10 |
| TCM1210-201-2P | 200 | 2.7 | 0.1 | 10 | 10 |
| TCM1210-301-2P | 300 | 3.5 | 0.05 | 10 | 10 |
| TCM1608-350-4P | 35 | 0.85 | 0.1 | 10 | 10 |
| TCM1608-650-4P | 65 | 1.3 | 0.1 | 10 | 10 |
| TCM1608-900-4P | 90 | 1.5 | 0.1 | 10 | 10 |
| TCM1608-201-4P | 200 | 3.0 | 0.05 | 10 | 10 |

· Operating temperature range: -25 to +85°C