

C1005C0G2A821J050BC

TDK Item Description : C1005C0G2A821JT****



Application & Main Feature

Commercial Grade (Mid Volatage (100 to 630V))

Series

C1005 [EIA 0402]

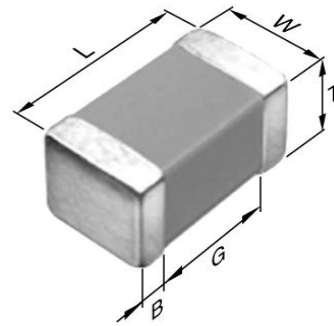

Dimensions

L	1.00mm +/-0.05mm
W	0.50mm +/-0.05mm
T	0.50mm +/-0.05mm
B	0.10mm Min.
G	0.30mm Min.

Temperature Characteristic

C0G (-55 to 125 degC 0+/-30ppm/degC)

Rated Voltage

2A (100Vdc)

Capacitance

820pF

Capacitance Tolerance

J (+/-5%)

Q Factor

1000 Min.

Insulation Resistance

10Gohm Min

AEC-Q200

Not Applicable

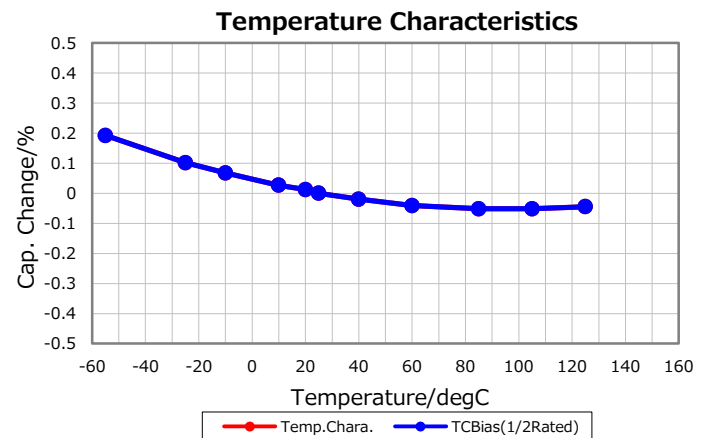
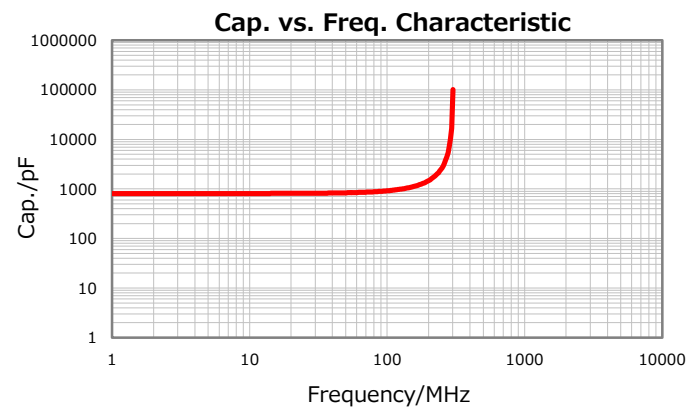
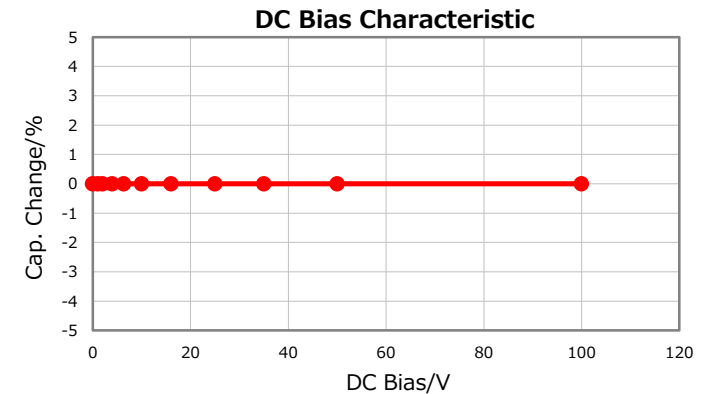
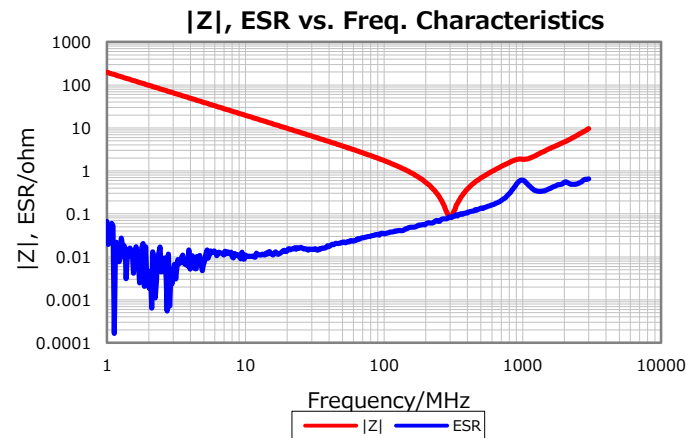

Characterization Sheet (Multilayer Ceramic Chip Capacitors)



All specifications are subject to change without notice.

July 6, 2016