

C1005X8R1H102K050BE

TDK Item Description : C1005X8R1H102KT***S



Application & Main Feature

Commercial Grade (Soft Termination)

Series

C1005 [EIA CC0402]

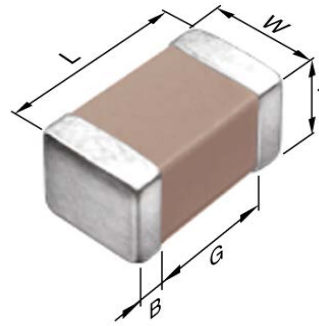

Dimensions

L	1.00mm +0.15,-0.05mm
W	0.50mm +0.1,-0.05mm
T	0.50mm +0.1,-0.05mm
B	0.10mm Min.
G	0.30mm Min.

Temperature Characteristic

X8R (-55 to 150 degC +/-15%)

Rated Voltage

1H (50Vdc)

Capacitance

1nF

Capacitance Tolerance

K (+/-10%)

Dissipation Factor

3% Max.

Insulation Resistance

10Gohm Min

AEC-Q200

Not Applicable

|Z|, ESR vs. Freq. Characteristics (Simulation Data)

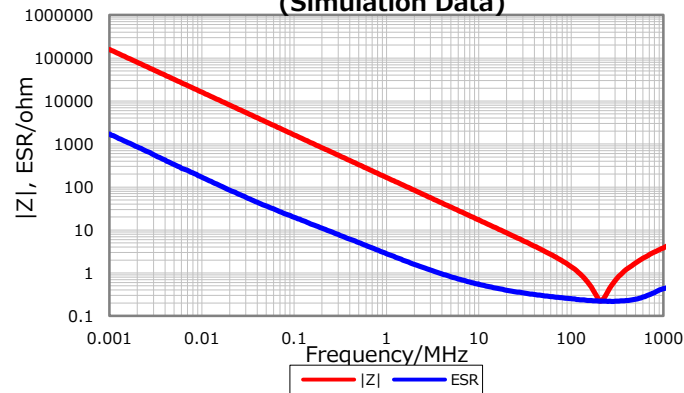

Cap. vs. Freq. Characteristic

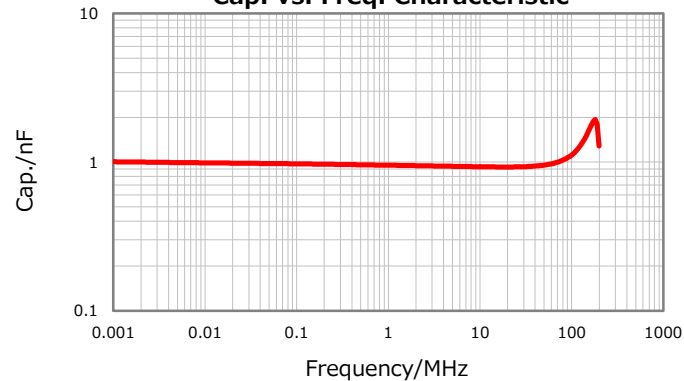

DC Bias Characteristic

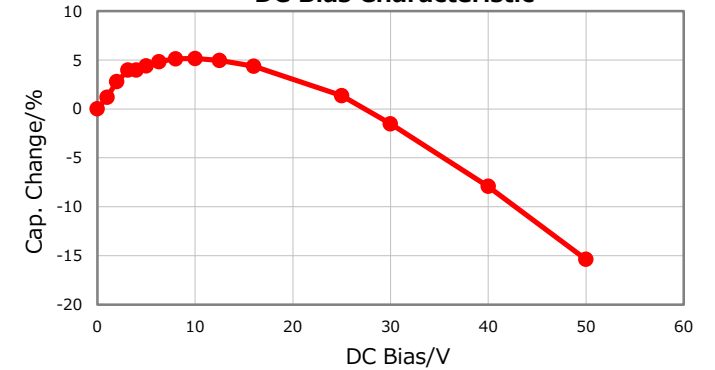

Temperature Characteristics

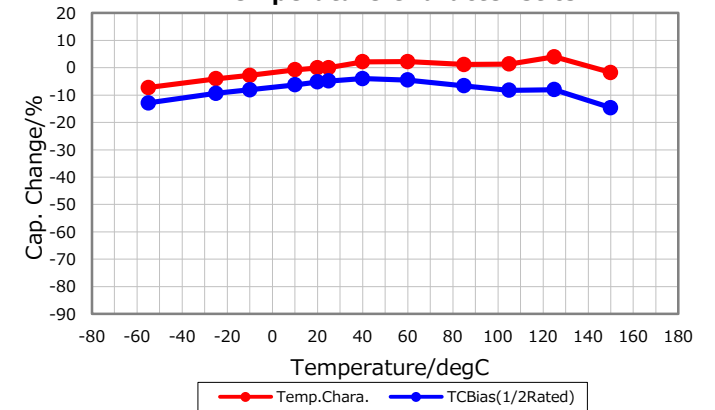

Ripple Temperature Rise Characteristics

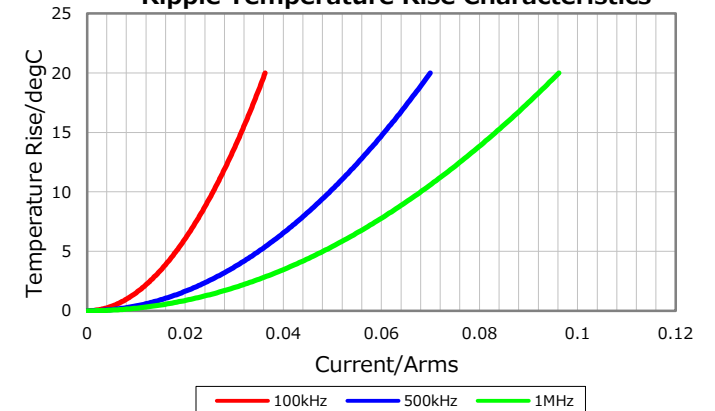

Characterization Sheet (Multilayer Ceramic Chip Capacitors)



All specifications are subject to change without notice.

March 16, 2017