

# C1608C0G1H332J080AA

TDK Item Description : C1608C0G1H332JT\*\*\*\*



## Application & Main Feature

Commercial Grade(Up to 50V)

## Series

C1608 [EIA 0603]

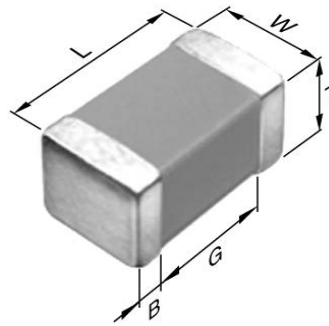

## Dimensions

L	1.60mm ±0.10mm
W	0.80mm ±0.10mm
T	0.80mm ±0.10mm
B	0.20mm Min.
G	0.30mm Min.

## Temperature Characteristic

C0G (-55 to 125 degC 0+/-30ppm/degC)

## Rated Voltage

1H(50Vdc)

## Capacitance

3.3nF

## Capacitance Tolerance

J (±5%)

## Q Factor

1000 Min.

## Insulation Resistance

10Gohm Min

## AEC-Q200

Not Applicable

## DC Bias Characteristic

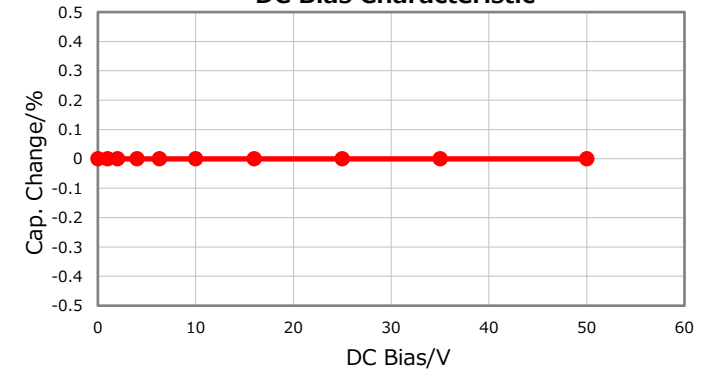

## |Z|, ESR vs. Freq. Characteristics

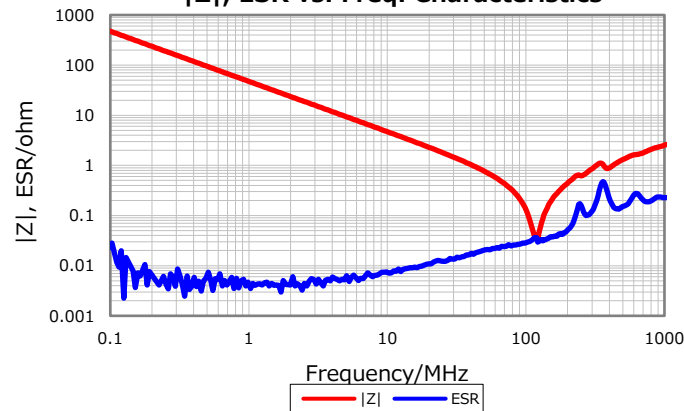

## Temperature Characteristics

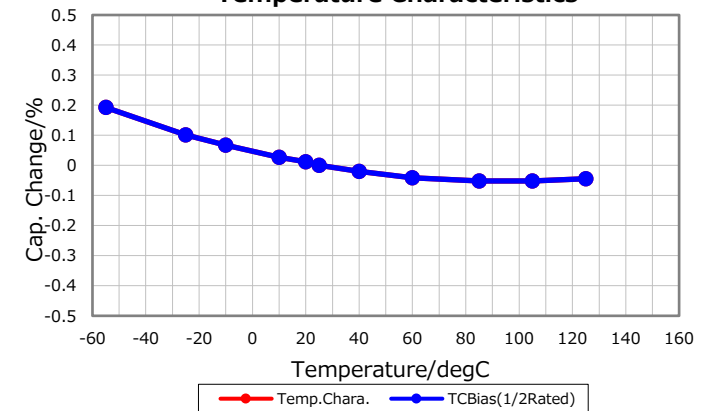

## Cap. vs. Freq. Characteristic

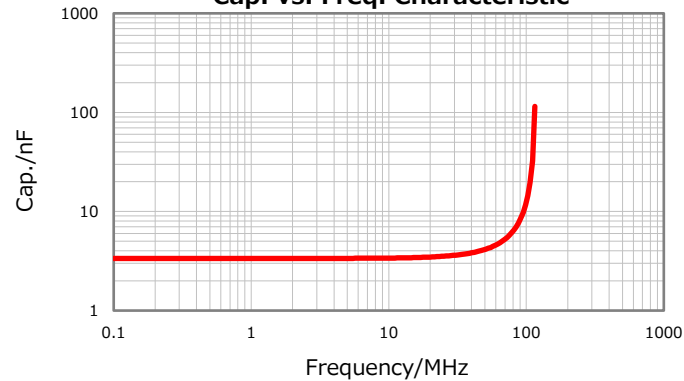

## Ripple Temperature Rise Characteristics

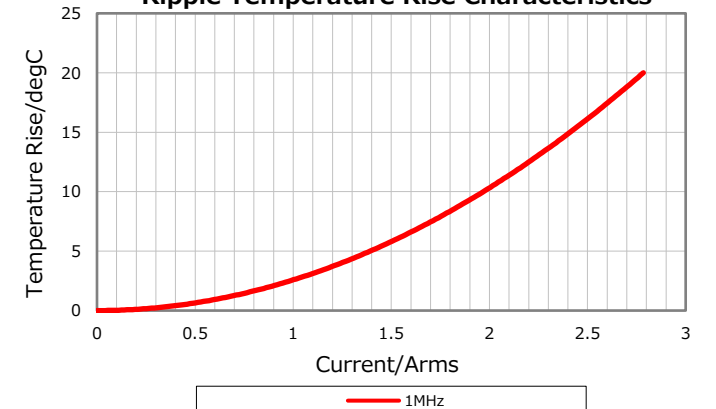

Characterization Sheet (Multilayer Ceramic Chip Capacitors)



All specifications are subject to change without notice.

May 21, 2019