

## Application & Main Feature

Commercial Grade ( Soft Termination )

## Series

C1608 [EIA 0603]

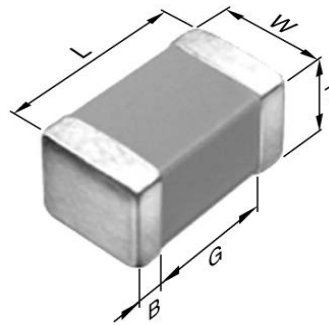

## Dimensions

L	1.60mm +0.2,-0.1mm
W	0.80mm +0.15,-0.1mm
T	0.80mm +0.15,-0.1mm
B	0.20mm Min.
G	0.30mm Min.

## Temperature Characteristic

C0G (-55 to 125 degC 0+/-30ppm/degC)

## Rated Voltage

2A(100Vdc)

## Capacitance

2.7nF

## Capacitance Tolerance

J (±5%)

## Q Factor

1000 Min.

## Insulation Resistance

10Gohm Min

## AEC-Q200

Not Applicable

## |Z|, ESR vs. Freq. Characteristics (Simulation Data)

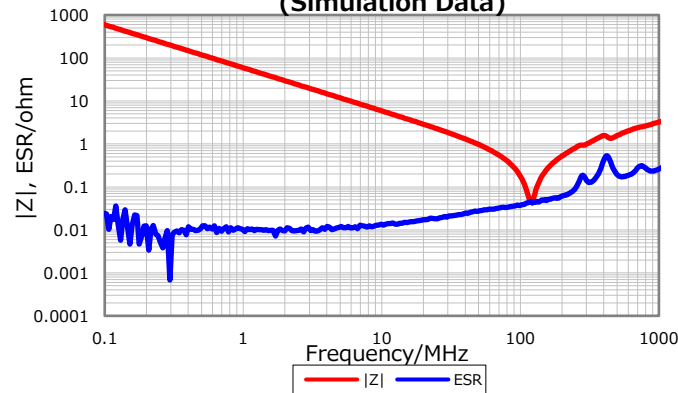

## Cap. vs. Freq. Characteristic

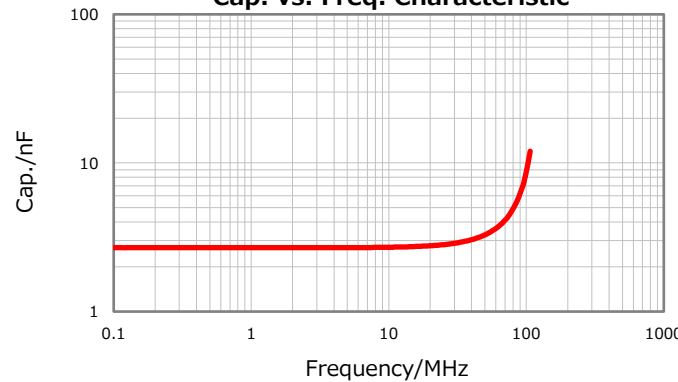

## DC Bias Characteristic

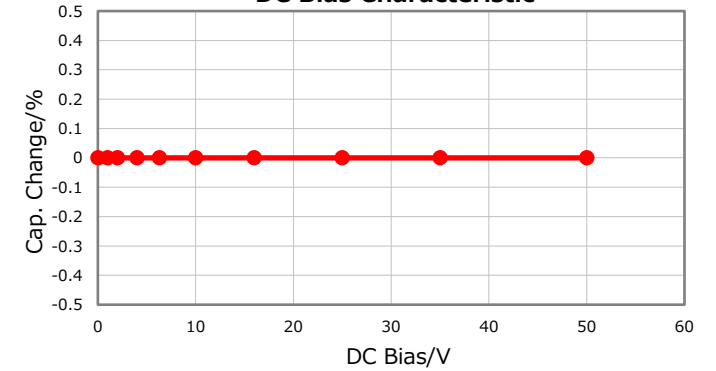

## Temperature Characteristics

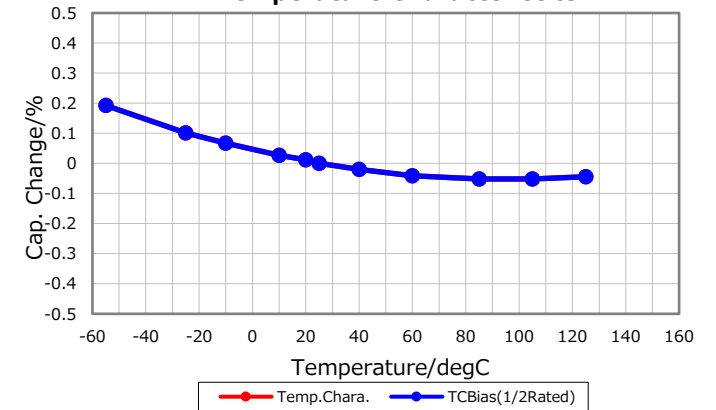

## Ripple Temperature Rise Characteristics

