

# C1608JB1H474K080AB

TDK Item Description : C1608JB1H474KT\*\*\*



## Application & Main Feature

Commercial Grade ( General (Up to 50V) )

## Series

C1608 [EIA CC0603]

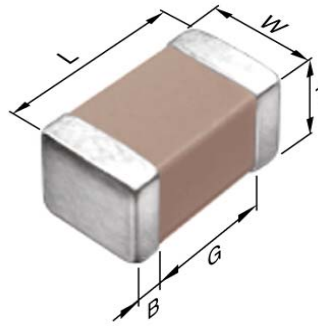

## Dimensions

L 1.60mm +/-0.1mm  
 W 0.80mm +/-0.1mm  
 T 0.80mm +/-0.1mm  
 B 0.20mm Min.  
 G 0.30mm Min.

## Temperature Characteristic

JB (-25 to 85 degC +/-10%)

## Rated Voltage

1H (50Vdc)

## Capacitance

470nF

## Capacitance Tolerance

K (+/-10%)

## Dissipation Factor

5% Max.

## Insulation Resistance

1.06Gohm Min.

## AEC-Q200

Not Applicable

## DC Bias Characteristic

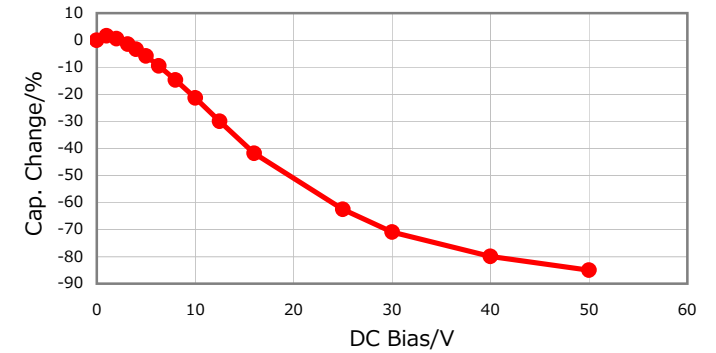

## |Z|, ESR vs. Freq. Characteristics

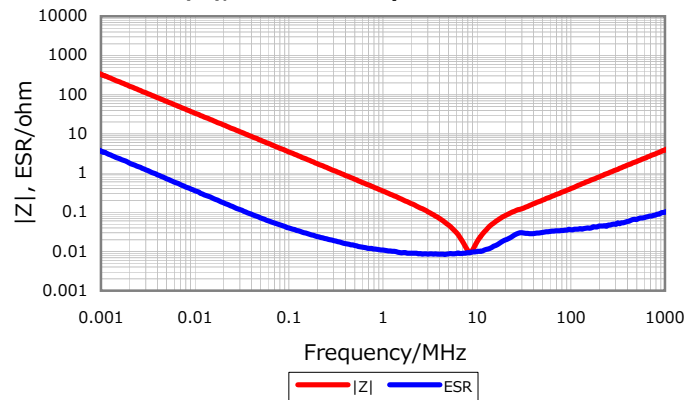

## Temperature Characteristics

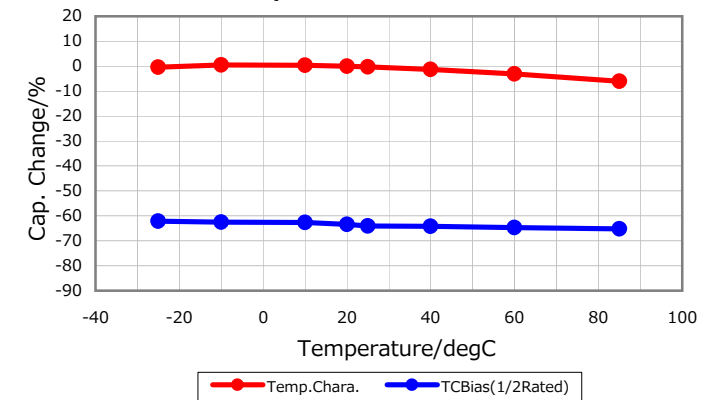

## Cap. vs. Freq. Characteristic

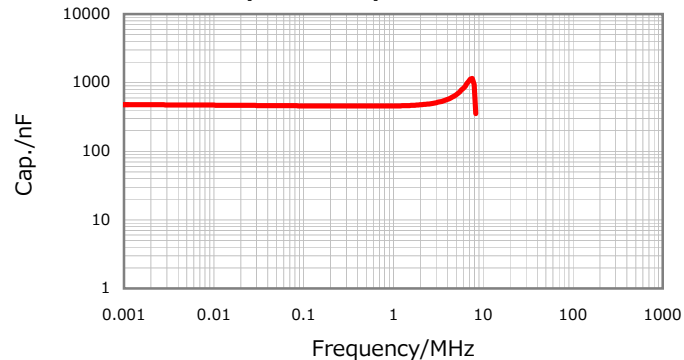

## Ripple Temperature Rise Characteristics

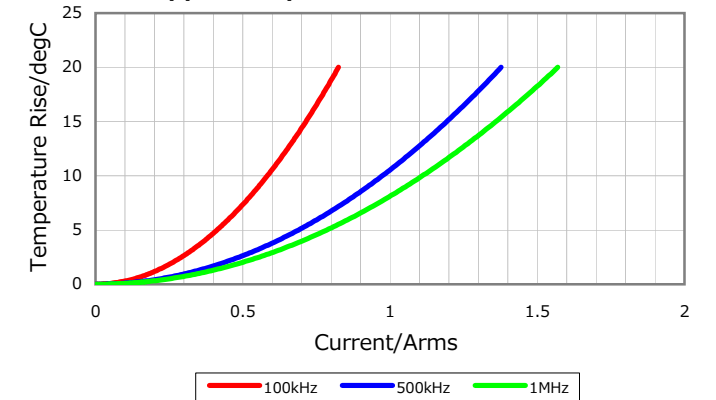

Characterization Sheet ( Multilayer Ceramic Chip Capacitors )



All specifications are subject to change without notice.

January 3, 2016