

# C1608X8R1C474K080AB

TDK Item Description : C1608X8R1C474KT\*\*\*\*



## Application & Main Feature

Commercial Grade ( High Temperature Application )

## Series

C1608 [EIA 0603]

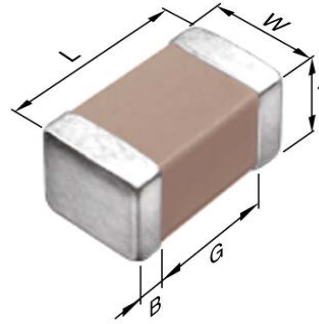

## Dimensions

L	1.60mm +/-0.15mm
W	0.80mm +/-0.15mm
T	0.80mm +/-0.15mm
B	0.20mm Min.
G	0.30mm Min.

## Temperature Characteristic

X8R (-55 to 150 deg +/-15%)

## Rated Voltage

1C (16Vdc)

## Capacitance

470nF

## Capacitance Tolerance

K (+/-10%)

## Dissipation Factor

5% Max.

## Insulation Resistance

212Mohm Min.

## AEC-Q200

Not Applicable

## |Z|, ESR vs. Freq. Characteristics

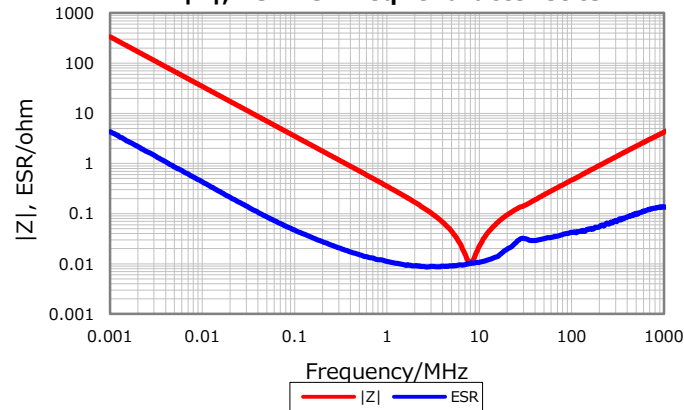

## Cap. vs. Freq. Characteristic

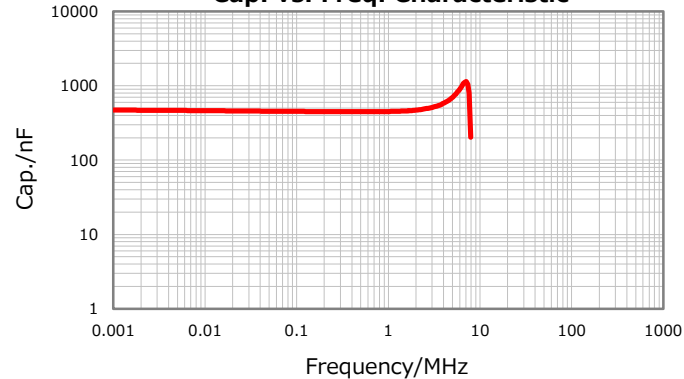

## DC Bias Characteristic

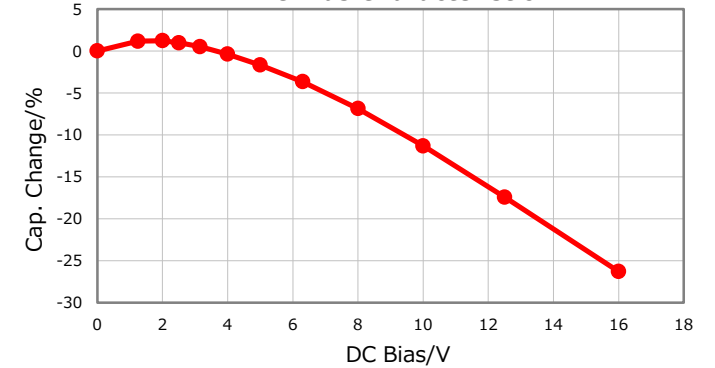

## Temperature Characteristics

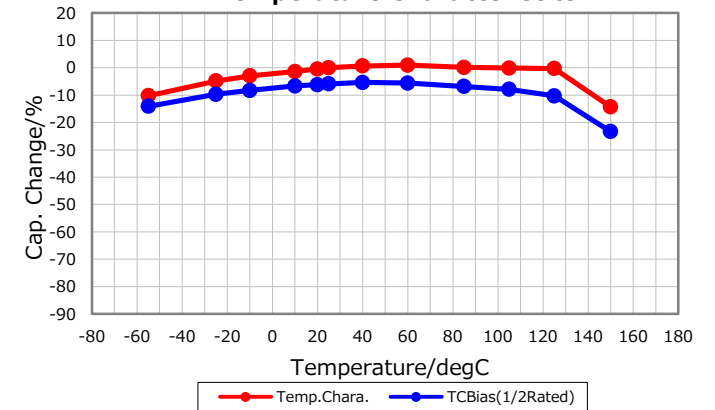

## Ripple Temperature Rise Characteristics

