

C2012C0G1H472J060AA

TDK Item Description : C2012C0G1H472JT****



Application & Main Feature

Commercial Grade(Up to 50V)

Series

C2012 [EIA 0805]

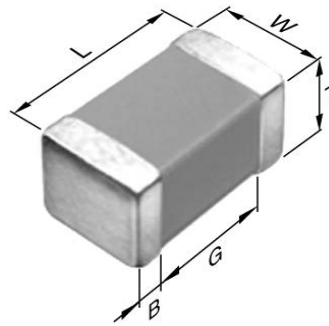

Dimensions

L	2.00mm ±0.20mm
W	1.25mm ±0.20mm
T	0.60mm ±0.15mm
B	0.20mm Min.
G	0.50mm Min.

Temperature Characteristic

C0G (-55 to 125 degC 0+/-30ppm/degC)

Rated Voltage

1H(50Vdc)

Capacitance

4.7nF

Capacitance Tolerance

J (±5%)

Q Factor

1000 Min.

Insulation Resistance

10Gohm Min

AEC-Q200

Not Applicable

|Z|, ESR vs. Freq. Characteristics

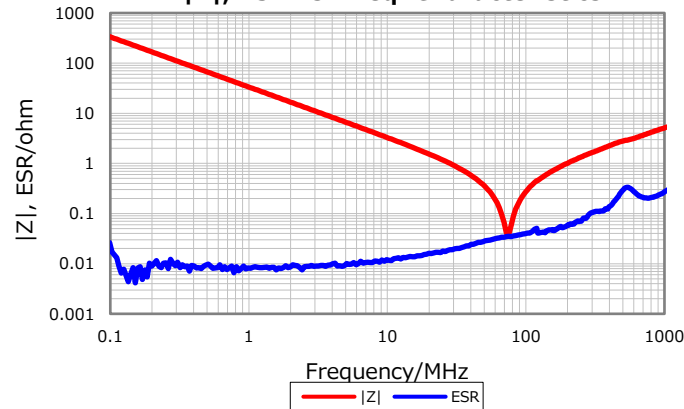

Cap. vs. Freq. Characteristic

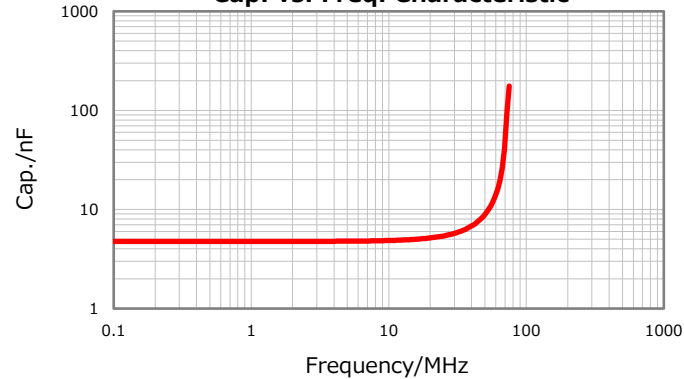

DC Bias Characteristic

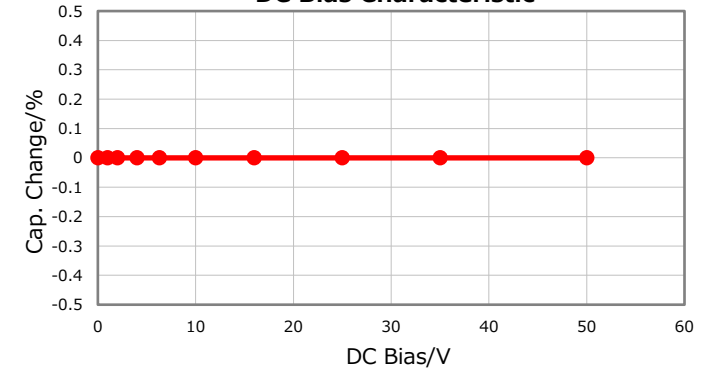

Temperature Characteristics

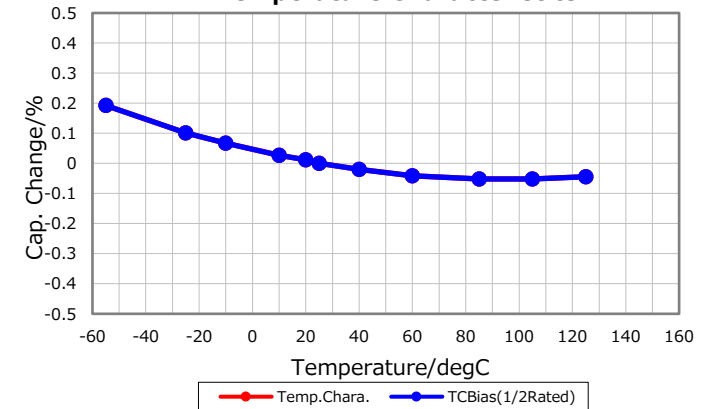

Ripple Temperature Rise Characteristics

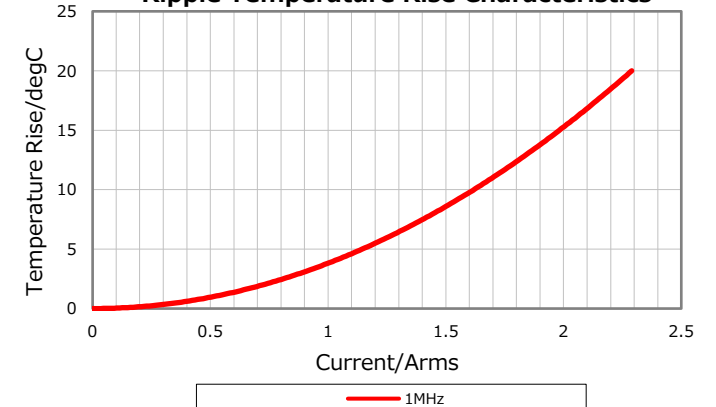

Characterization Sheet (Multilayer Ceramic Chip Capacitors)



All specifications are subject to change without notice.

May 21, 2019