

# C2012X7R1H104K085AA

TDK Item Description : C2012X7R1H104KT\*\*\*\*



## Application & Main Feature

Commercial Grade ( General (Up to 50V) )

## Series

C2012 [EIA CC0805]

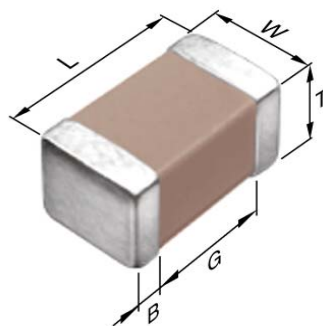

## Dimensions

L 2.00mm +/-0.2mm  
 W 1.25mm +/-0.2mm  
 T 0.85mm +/-0.15mm  
 B 0.20mm Min.  
 G 0.50mm Min.

## Temperature Characteristic

X7R (-55 to 125 degC +/-15%)

## Rated Voltage

1H (50Vdc)

## Capacitance

100nF

## Capacitance Tolerance

K (+/-10%)

## Dissipation Factor

3% Max.

## Insulation Resistance

5Gohm Min.

## AEC-Q200

Not Applicable

## DC Bias Characteristic

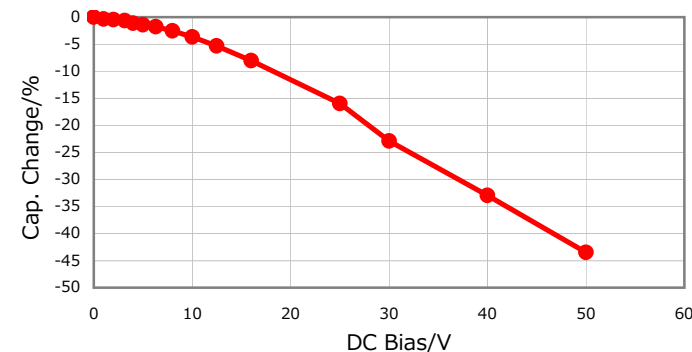

## |Z|, ESR vs. Freq. Characteristics

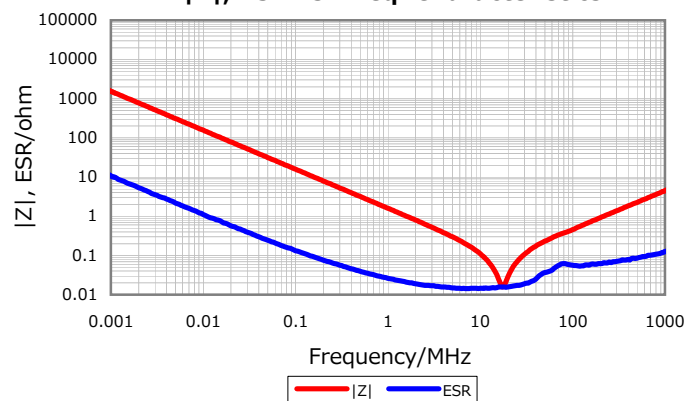

## Temperature Characteristics

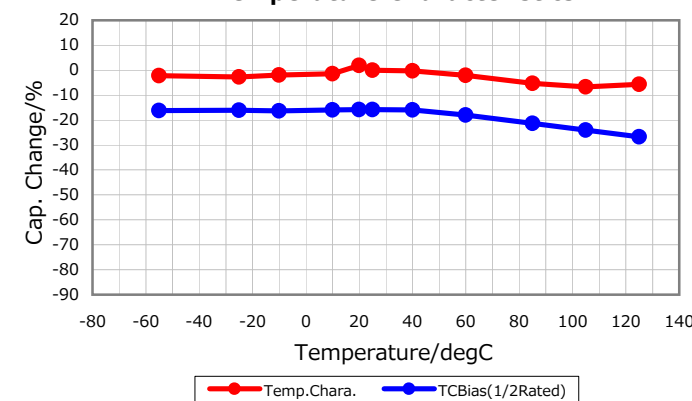

## Cap. vs. Freq. Characteristic

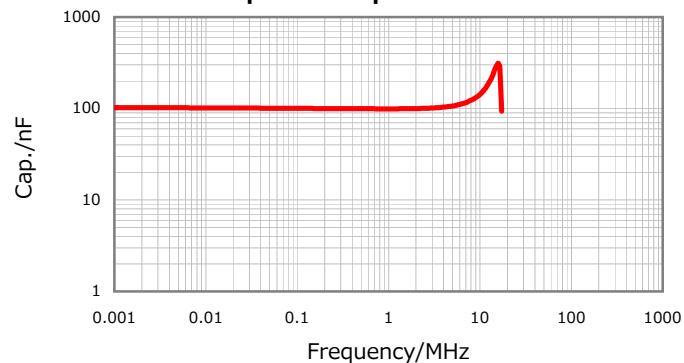

## Ripple Temperature Rise Characteristics

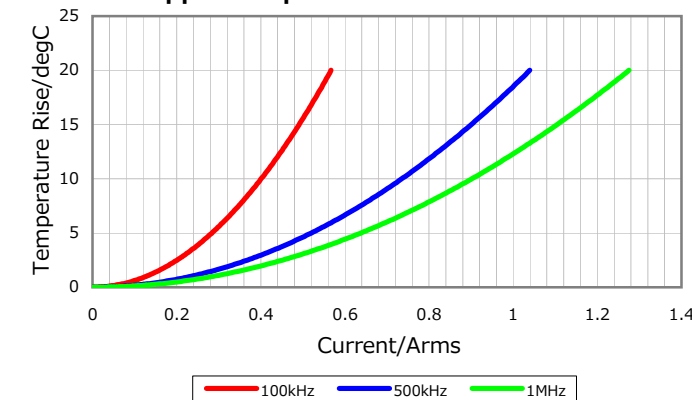

Characterization Sheet ( Multilayer Ceramic Chip Capacitors )



All specifications are subject to change without notice.

January 3, 2016