

Application & Main Feature

Commercial Grade (Soft Termination)

Series

C3216 [EIA 1206]

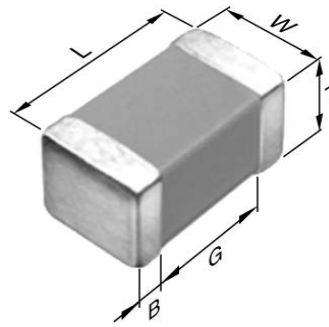

Dimensions

L	3.20mm +0.4,-0.2mm
W	1.60mm +0.3,-0.2mm
T	1.15mm ±0.15mm
B	0.20mm Min.
G	1.00mm Min.

Temperature Characteristic

C0G (-55 to 125 degC 0+/-30ppm/degC)

Rated Voltage

2J(630Vdc)

Capacitance

6.8nF

Capacitance Tolerance

J (±5%)

Q Factor

1000 Min.

Insulation Resistance

10Gohm Min

AEC-Q200

Not Applicable

|Z|, ESR vs. Freq. Characteristics (Simulation Data)

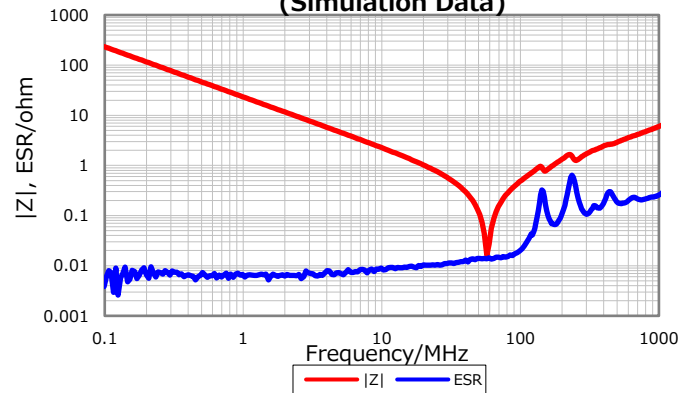

Cap. vs. Freq. Characteristic

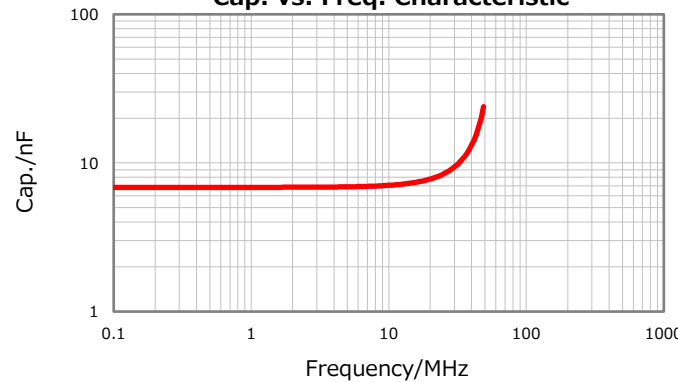

DC Bias Characteristic

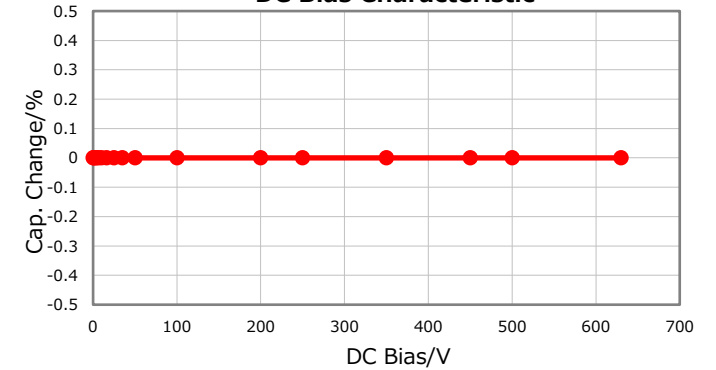

Temperature Characteristics



Ripple Temperature Rise Characteristics

