

# C3216X7R2J102K115AE

TDK Item Description : C3216X7R2J102KT\*\*\*S



## Application & Main Feature

Commercial Grade ( Soft Termination )

## Series

C3216 [EIA CC1206]

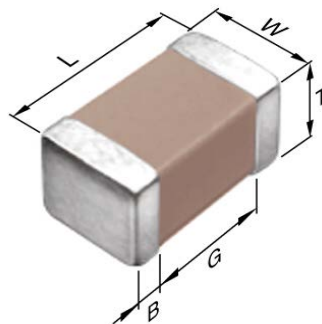

## Dimensions

L	3.20mm +0.4,-0.2mm
W	1.60mm +0.3,-0.2mm
T	1.15mm +/-0.15mm
B	0.20mm Min.
G	1.00mm Min.

## Temperature Characteristic

X7R (-55 to 125 degC +/-15%)

## Rated Voltage

2J (630Vdc)

## Capacitance

1nF

## Capacitance Tolerance

K (+/-10%)

## Dissipation Factor

3% Max.

## Insulation Resistance

10Gohm Min

## AEC-Q200

Not Applicable

## |Z|, ESR vs. Freq. Characteristics (Simulation Data)

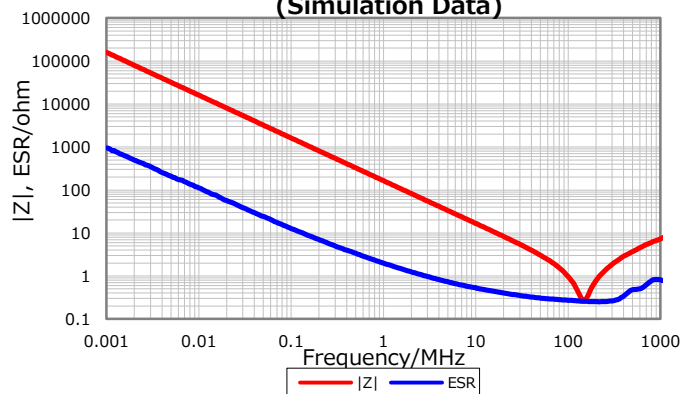

## Cap. vs. Freq. Characteristic

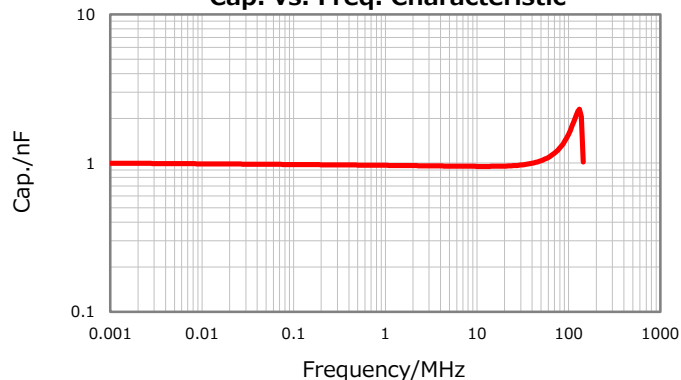

## DC Bias Characteristic

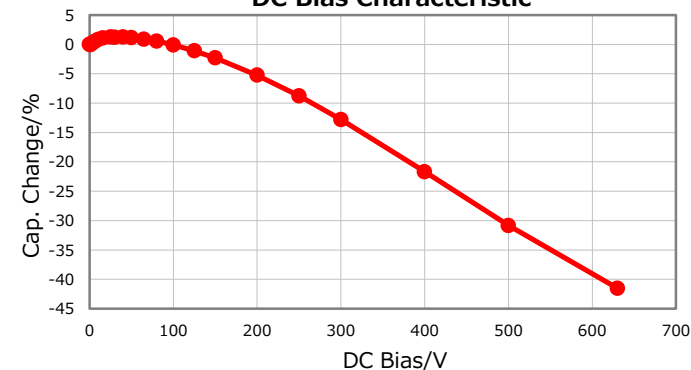

## Temperature Characteristics

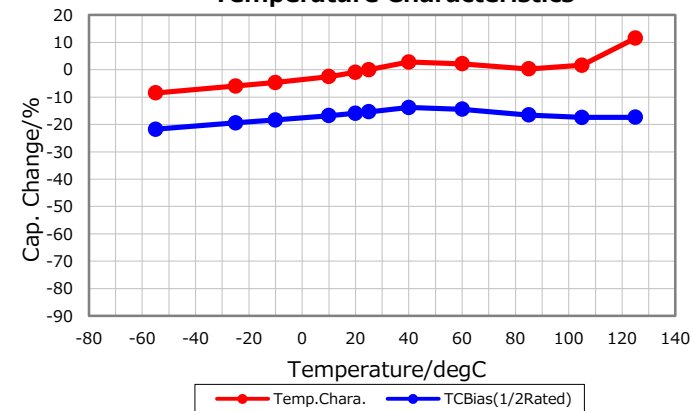

## Ripple Temperature Rise Characteristics

