

C3216X8R1E155K160AE

TDK Item Description : C3216X8R1E155KT***S



Application & Main Feature

Commercial Grade (Soft Termination)

Series

C3216 [EIA CC1206]

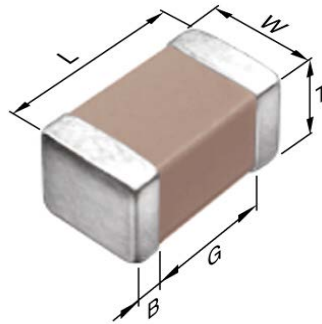

Dimensions

L	3.20mm +0.4,-0.2mm
W	1.60mm +0.3,-0.2mm
T	1.60mm +0.3,-0.2mm
B	0.20mm Min.
G	1.00mm Min.

Temperature Characteristic

X8R (-55 to 150 degC +/-15%)

Rated Voltage

1E (25Vdc)

Capacitance

1.5uF

Capacitance Tolerance

K (+/-10%)

Dissipation Factor

3% Max.

Insulation Resistance

333Mohm Min.

AEC-Q200

Not Applicable

|Z|, ESR vs. Freq. Characteristics (Simulation Data)

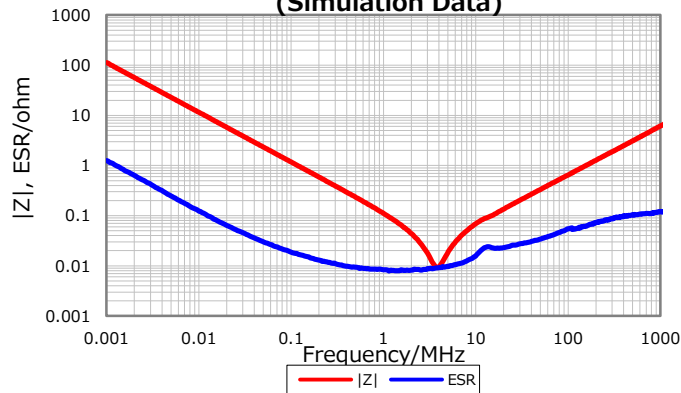

Cap. vs. Freq. Characteristic

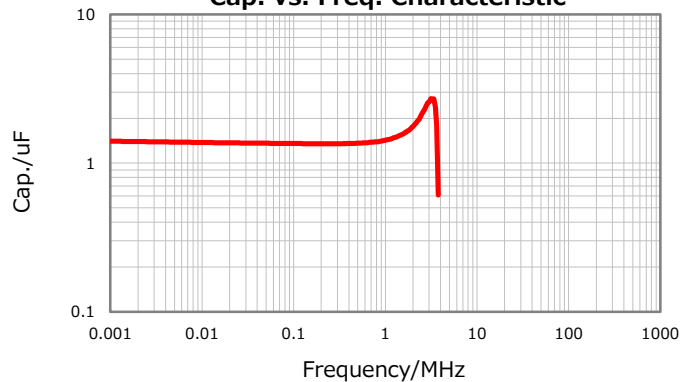

DC Bias Characteristic

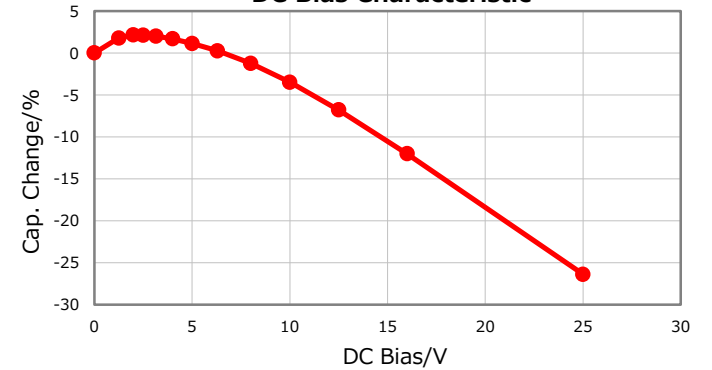

Temperature Characteristics

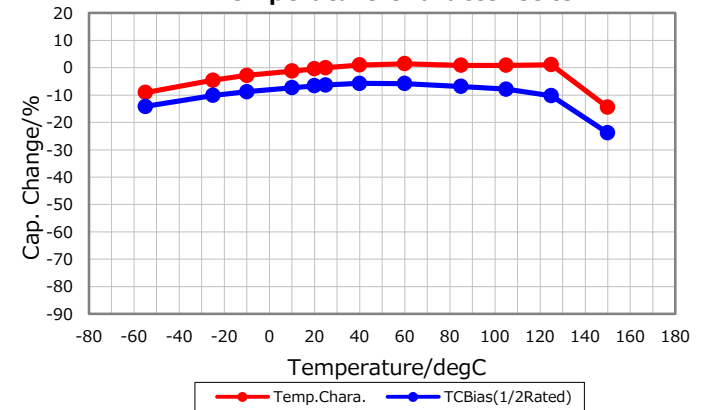

Ripple Temperature Rise Characteristics

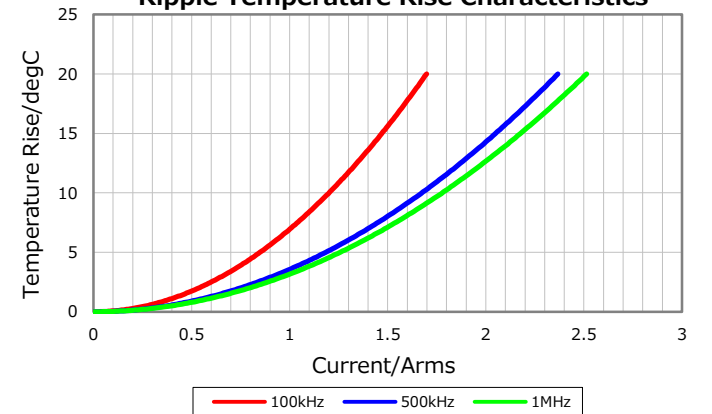

Characterization Sheet (Multilayer Ceramic Chip Capacitors)



All specifications are subject to change without notice.

March 16, 2017