

# CGA1A2C0G1E010C030BA

TDK Item Description : CGA1A2C0G1E010CT\*\*\*\*



Equivalent C0603C0G1E010C for Automotive

## Application & Main Feature

Automotive Grade ( General (Up to 50V) )

## Series

CGA1(0603) [EIA CC0201]

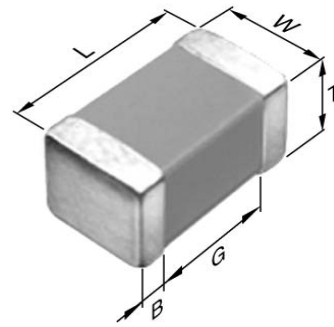

## Dimensions

L 0.60mm +/-0.03mm  
 W 0.30mm +/-0.03mm  
 T 0.30mm +/-0.03mm  
 B 0.10mm Min.  
 G 0.20mm Min.

## Temperature Characteristic

C0G (-55 to 125 degC 0+/-30ppm/degC)

## Rated Voltage

1E (25Vdc)

## Capacitance

1pF

## Capacitance Tolerance

C (+/-0.25pF)

## Q Factor

420 Min.

## Insulation Resistance

10Gohm Min.

## AEC-Q200

Yes

**|Z|, ESR vs. Freq. Characteristics**

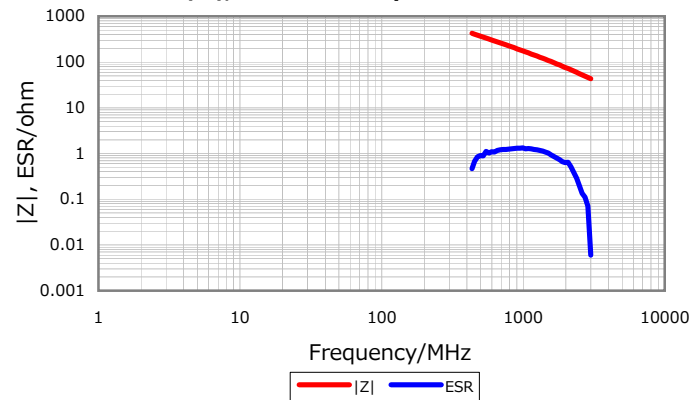

**DC Bias Characteristic**

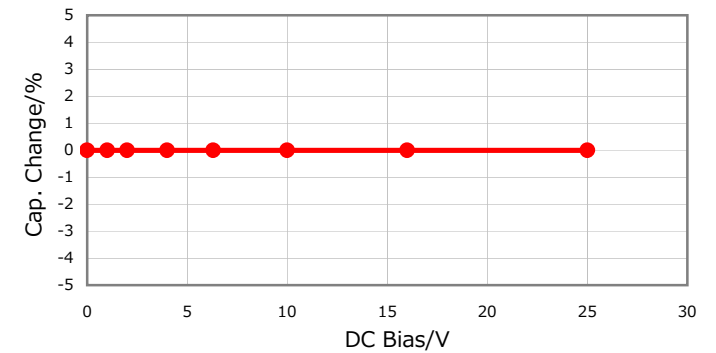

**Cap. vs. Freq. Characteristic**

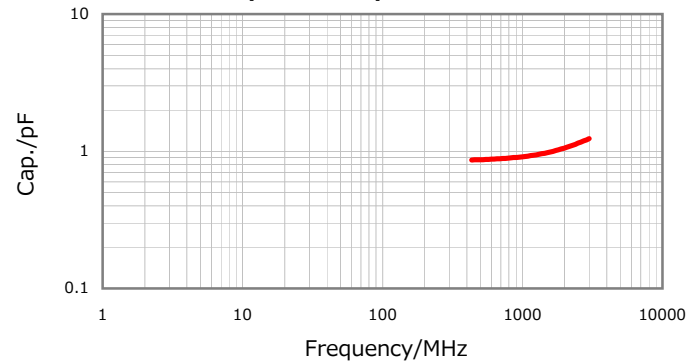

**Temperature Characteristics**

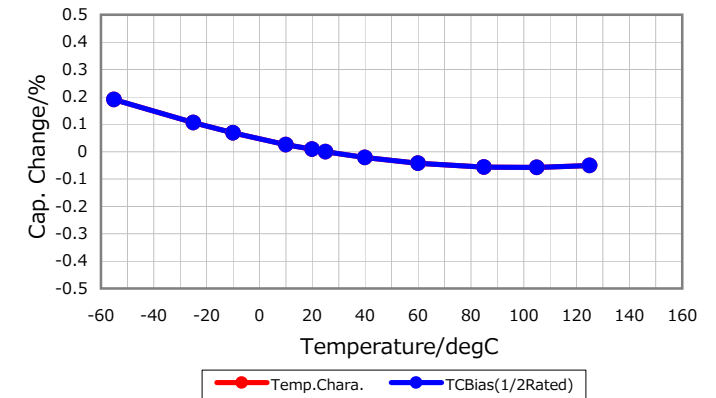

Characterization Sheet ( Multilayer Ceramic Chip Capacitors )



All specifications are subject to change without notice.

January 4, 2016