

CGA2B2C0G2A101J050BA

TDK Item Description : CGA2B2C0G2A101JT***



Application & Main Feature

Automotive Grade (Mid Voltage (100 to 630V))

Series

CGA2(1005) [EIA CC0402]

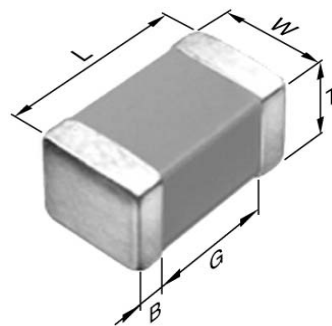

Dimensions

L 1.00mm +/-0.05mm
W 0.50mm +/-0.05mm
T 0.50mm +/-0.05mm
B 0.10mm Min.
G 0.30mm Min.

Temperature Characteristic

C0G (-55 to 125 degC 0+/-30ppm/degC)

Rated Voltage

2A (100Vdc)

Capacitance

100pF

Capacitance Tolerance

J (+/-5%)

Q Factor

1000 Min.

Insulation Resistance

10Gohm Min.

AEC-Q200

Yes

|Z|, ESR vs. Freq. Characteristics

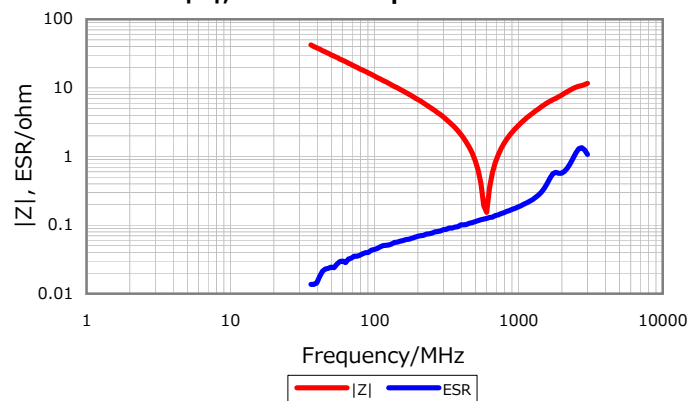

DC Bias Characteristic

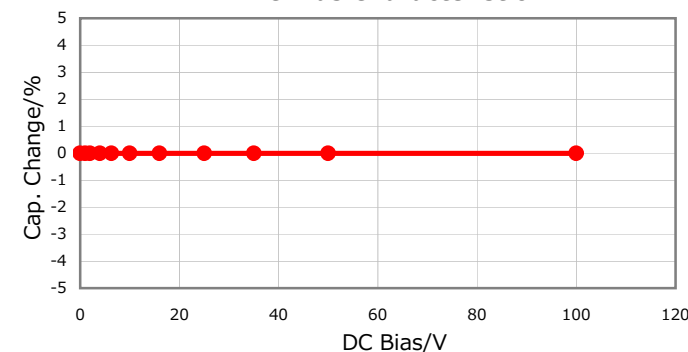

Cap. vs. Freq. Characteristic

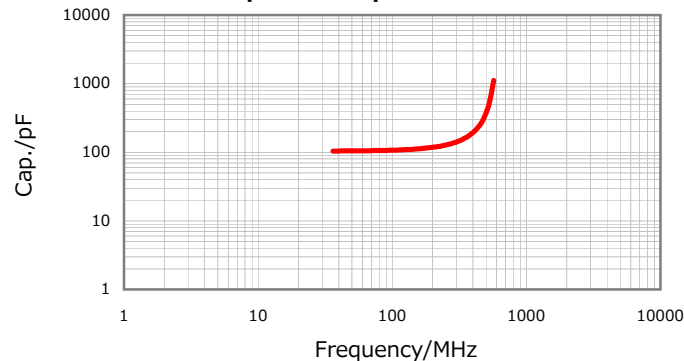

Temperature Characteristics

