

CGA3E2C0G1H392J080AD

TDK Item Description : CGA3E2C0G1H392JT***B



Equivalent C1608C0G1H392J for Automotive

Application & Main Feature

Automotive Grade (Conductive Epoxy Application)

Series

CGA3(1608) [EIA 0603]

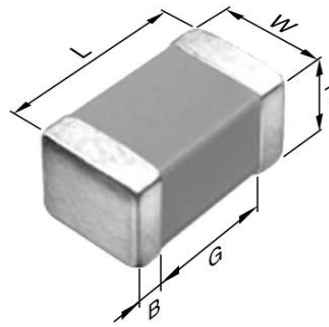

Dimensions

L	1.60mm ±0.15mm
W	0.80mm ±0.15mm
T	0.80mm ±0.15mm
B	0.20mm Min.
G	0.30mm Min.

Temperature Characteristic

C0G (-55 to 125 degC 0+/-30ppm/degC)

Rated Voltage

1H(50Vdc)

Capacitance

3.9nF

Capacitance Tolerance

J (±5%)

Q Factor

1000 Min.

Insulation Resistance

10Gohm Min

AEC-Q200

Yes

|Z|, ESR vs. Freq. Characteristics

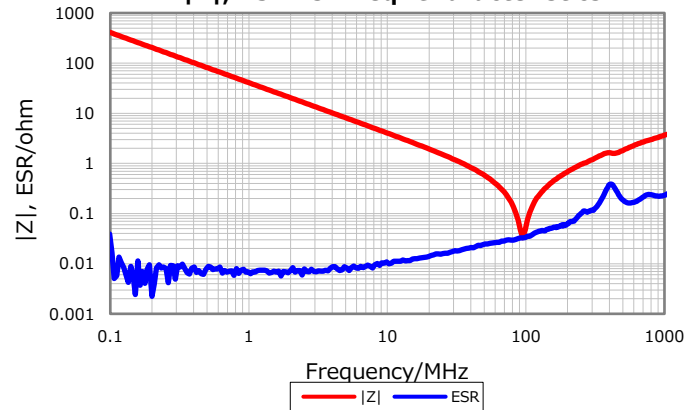

Cap. vs. Freq. Characteristic

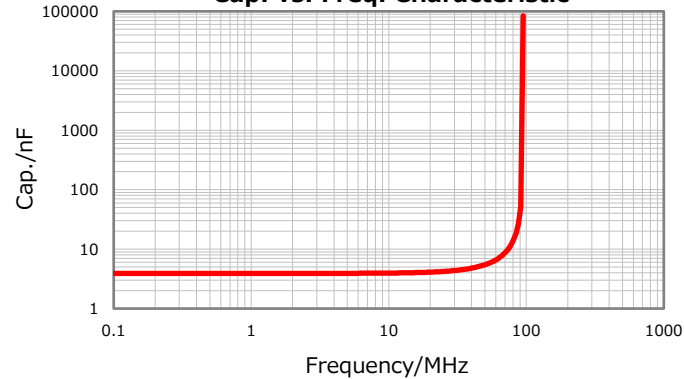

DC Bias Characteristic



Temperature Characteristics



Ripple Temperature Rise Characteristics



Characterization Sheet (Multilayer Ceramic Chip Capacitors)



All specifications are subject to change without notice.

May 22, 2019