

CGA3E2X7R1H104K080AE

TDK Item Description : CGA3E2X7R1H104KT***S



Equivalent C1608X7R1H104K for Automotive

Application & Main Feature

Automotive Grade (Soft Termination)

Series

CGA3(1608) [EIA CC0603]

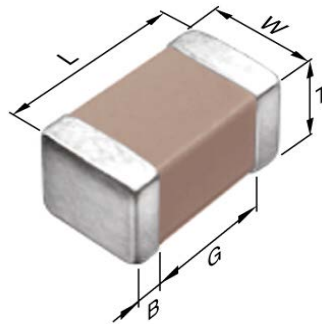

Dimensions

L	1.60mm +0.2,-0.1mm
W	0.80mm +0.15,-0.1mm
T	0.80mm +0.15,-0.1mm
B	0.20mm Min.
G	0.30mm Min.

Temperature Characteristic

X7R (-55 to 125 degC +/-15%)

Rated Voltage

1H (50Vdc)

Capacitance

100nF

Capacitance Tolerance

K (+/-10%)

Dissipation Factor

3% Max.

Insulation Resistance

5Gohm Min

AEC-Q200

Yes

|Z|, ESR vs. Freq. Characteristics (Simulation Data)

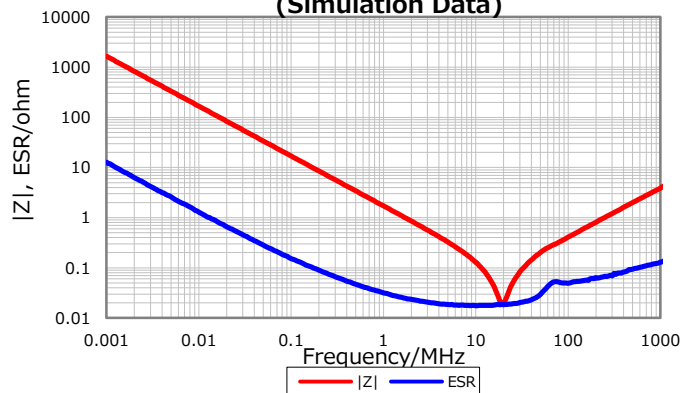

Cap. vs. Freq. Characteristic

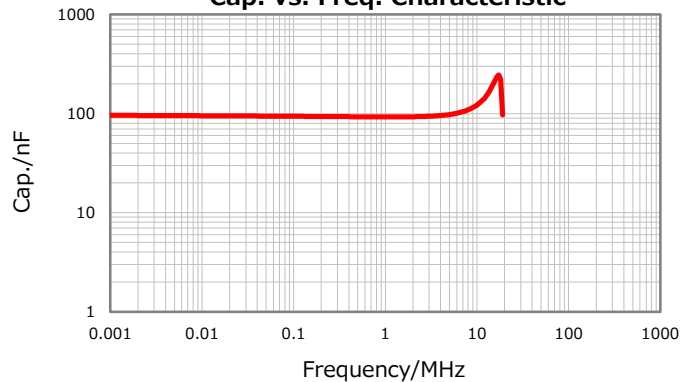

DC Bias Characteristic

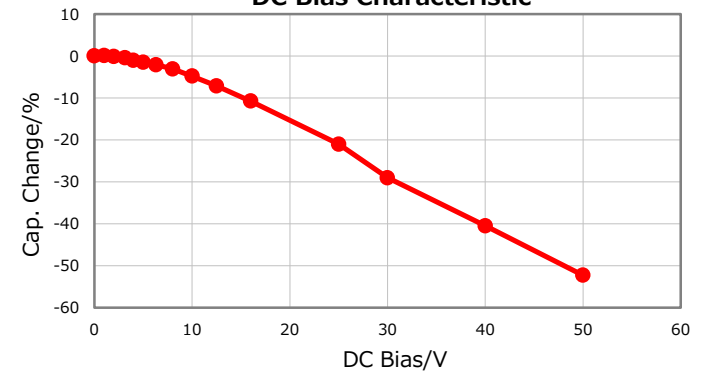

Temperature Characteristics

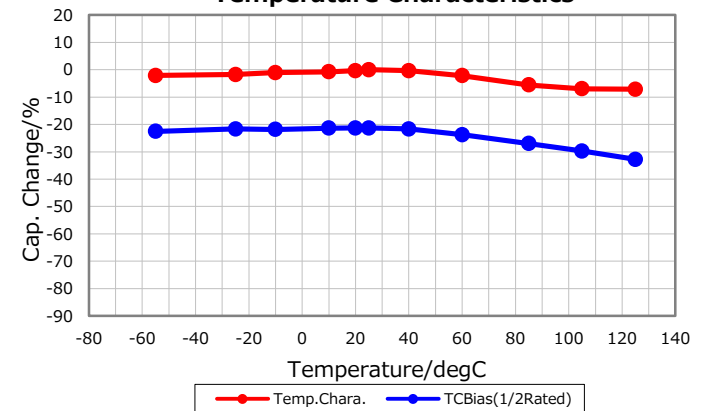

Ripple Temperature Rise Characteristics

