

CGA3E3X7R1V224K080AB

TDK item description : CGA3E3X7R1V224KT****



Equivalent C1608X7R1V224K for Automotive

Application & Main Feature

Automotive grade (General type)

Series

CGA3(1608) [EIA 0603]

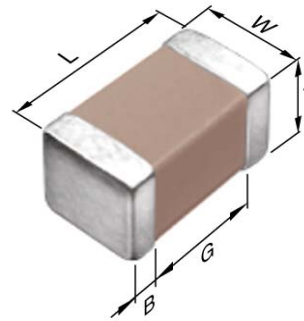

Dimensions

L	1.60±0.10 mm
W	0.80±0.10 mm
T	0.80±0.10 mm
B	0.20 mm min.
G	0.30 mm min.

Temperature Characteristic

X7R (-55 to +125 degC, ±15%)

Rated Voltage

1V (35Vdc)

Capacitance

220nF

Capacitance Tolerance

K (±10%)

Dissipation Factor

5 % max.

Insulation Resistance

2272 Mohm min.

AEC-Q200

Yes

Characterization Sheet (Multilayer Ceramic Chip Capacitors)

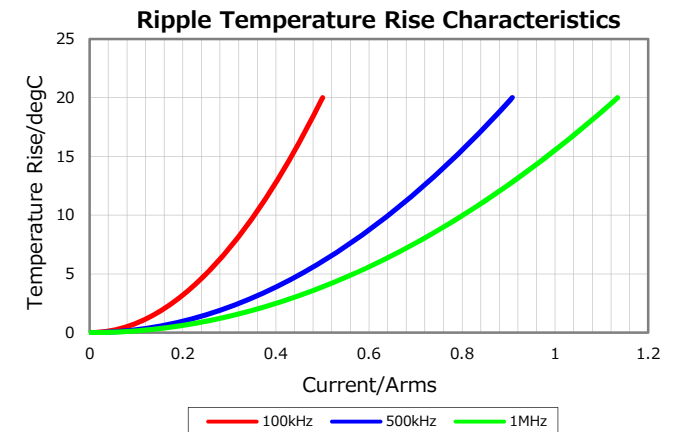
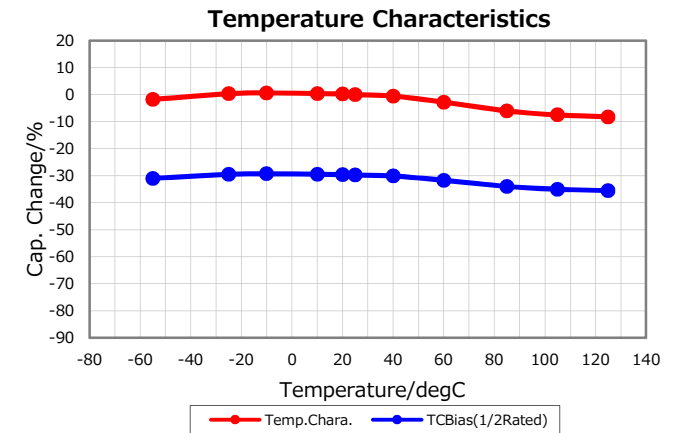
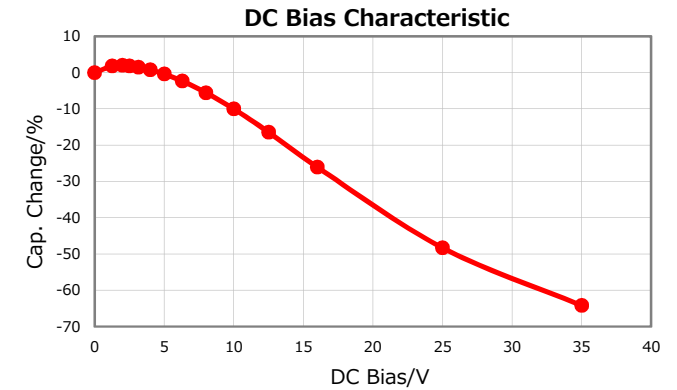
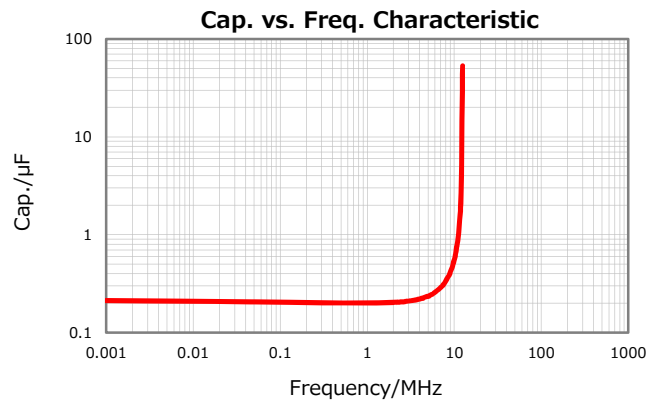
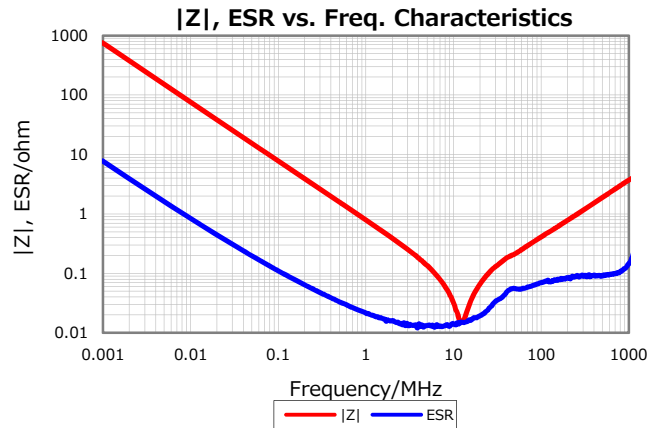

All specifications are subject to change without notice.

January 9, 2020