

# CGA4C2C0G1H272J060AA

TDK Item Description : CGA4C2C0G1H272JT\*\*\*\*



Equivalent C2012C0G1H272J for Automotive

## Application & Main Feature

Automotive Grade(Up to 50V)

## Series

CGA4(2012) [EIA 0805]

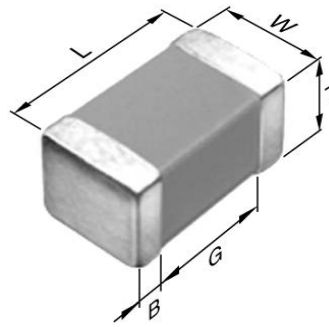

## Dimensions

L	2.00mm ±0.20mm
W	1.25mm ±0.20mm
T	0.60mm ±0.15mm
B	0.20mm Min.
G	0.50mm Min.

## Temperature Characteristic

C0G (-55 to 125 degC 0+/-30ppm/degC)

## Rated Voltage

1H(50Vdc)

## Capacitance

2.7nF

## Capacitance Tolerance

J (±5%)

## Q Factor

1000 Min.

## Insulation Resistance

10Gohm Min

## AEC-Q200

Yes

## DC Bias Characteristic



## |Z|, ESR vs. Freq. Characteristics

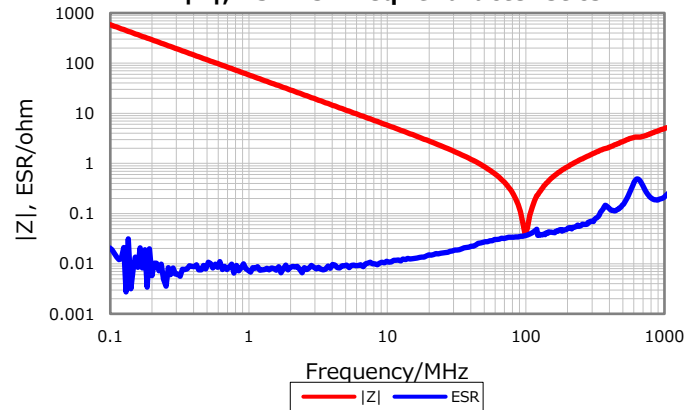

## Temperature Characteristics

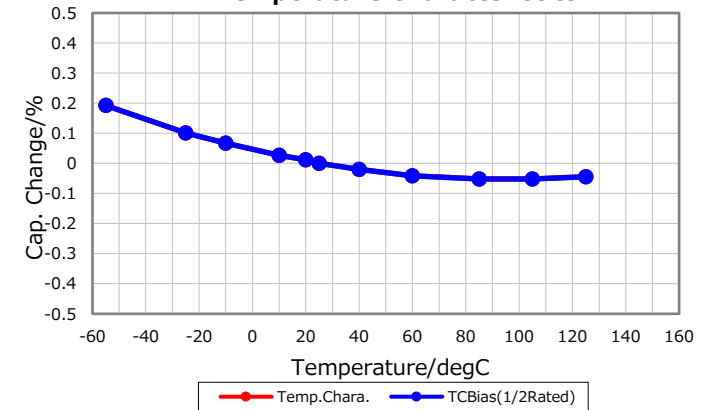

## Cap. vs. Freq. Characteristic

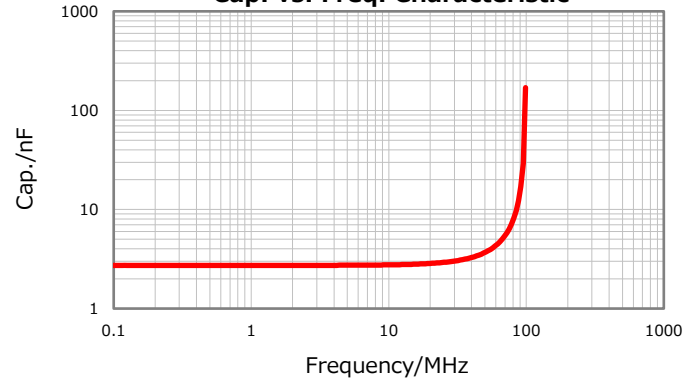

## Ripple Temperature Rise Characteristics

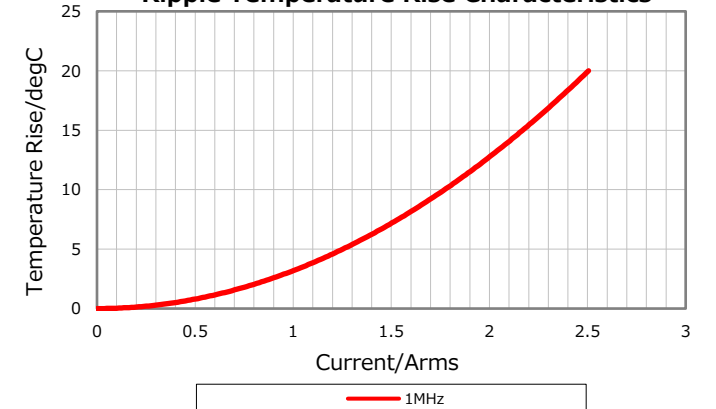

Characterization Sheet ( Multilayer Ceramic Chip Capacitors )



All specifications are subject to change without notice.

May 22, 2019