

CGA4J1X7R1V475M125AC

TDK item description : CGA4J1X7R1V475MT****



Equivalent C2012X7R1V475M for Automotive

Application & Main Feature

Automotive grade (General type)

Series

CGA4(2012) [EIA 0805]

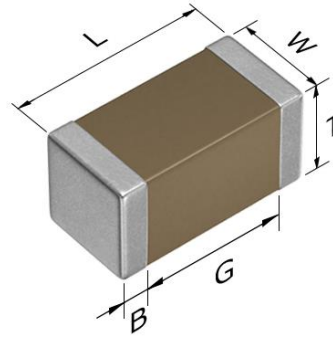

Dimensions

L 2.00±0.20 mm
 W 1.25±0.20 mm
 T 1.25±0.20 mm
 B 0.20 mm min.
 G 0.50 mm min.

Temperature Characteristic

X7R (-55 to +125 degC, ±15%)

Rated Voltage

1V (35Vdc)

Capacitance

4.7µF

Capacitance Tolerance

M (±20%)

DF

5 % max.

Insulation Resistance

106 Mohm min.

AEC-Q200

Yes

Characterization Sheet (Multilayer Ceramic Chip Capacitors)

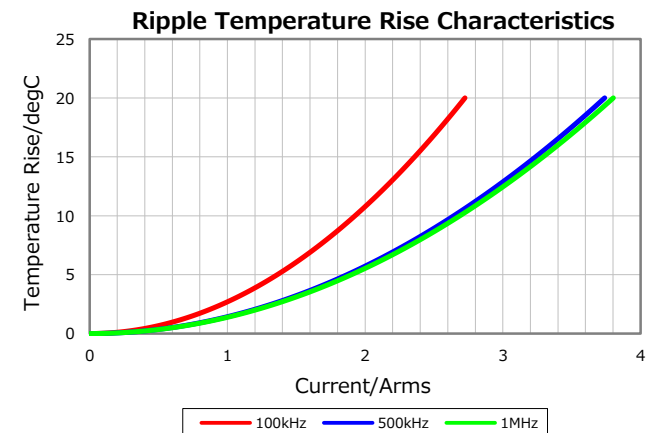
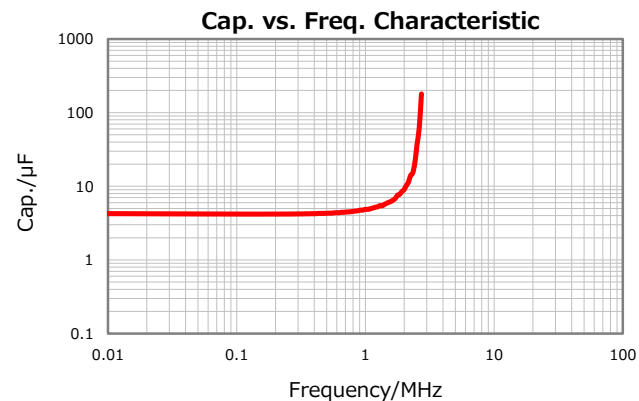
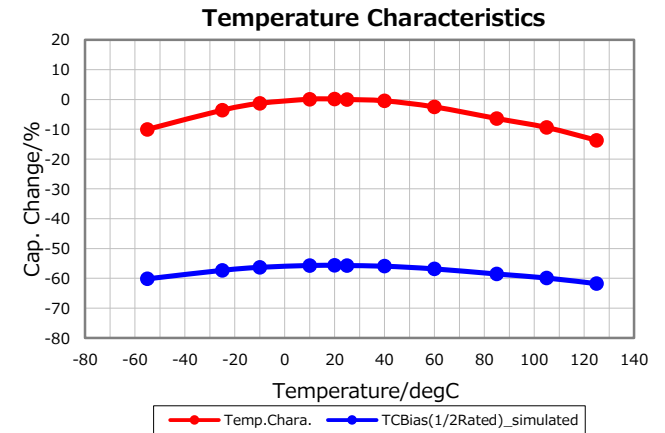
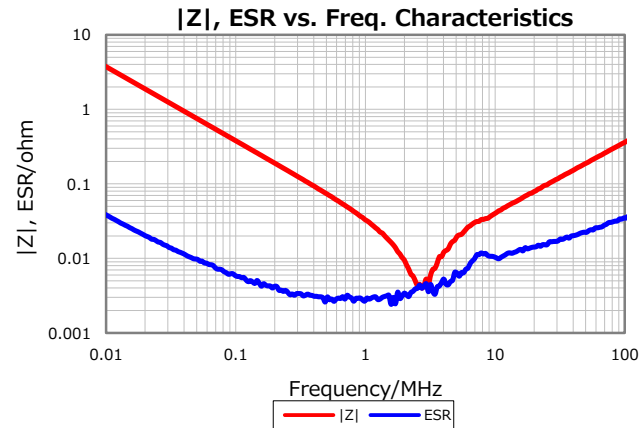
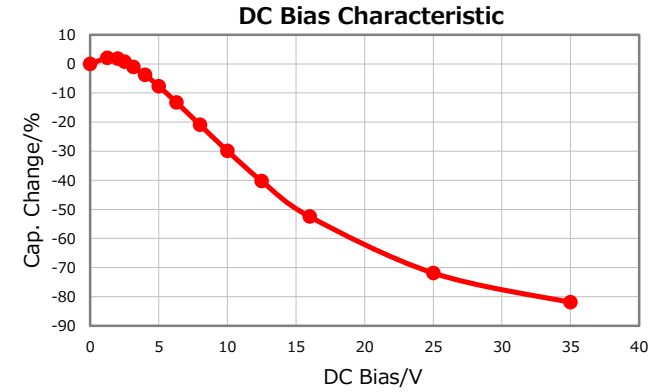

⚠ All specifications are subject to change without notice.

January 19, 2021