

CGA4J1X8L1H334K125AC

TDK item description : CGA4J1X8L1H334KT****



Equivalent C2012X8L1H334K for Automotive

Application & Main Feature

Automotive grade (General type)

Series

CGA4(2012) [EIA 0805]

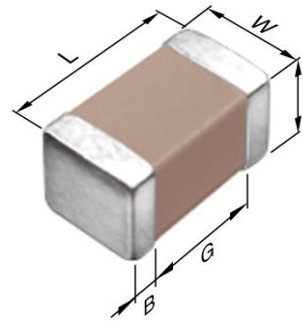

Dimensions

L	2.00±0.20 mm
W	1.25±0.20 mm
T	1.25±0.20 mm
B	0.20 mm min.
G	0.50 mm min.

Temperature Characteristic

X8L (-55 to +150 degC, +15/-40%)

Rated Voltage

1H (50Vdc)

Capacitance

330nF

Capacitance Tolerance

K (±10%)

DF

5 % max.

Insulation Resistance

1515 Mohm min.

AEC-Q200

Yes

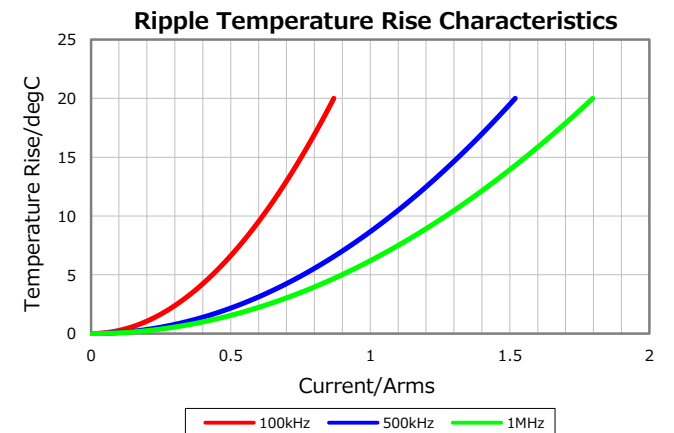
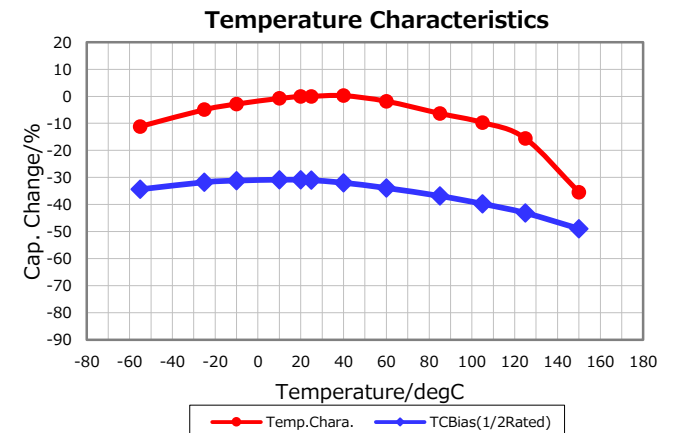
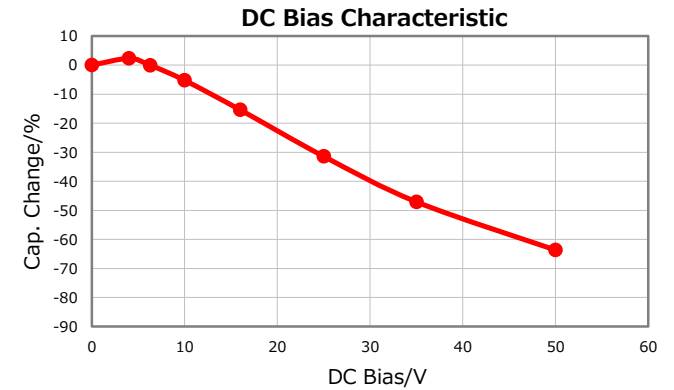
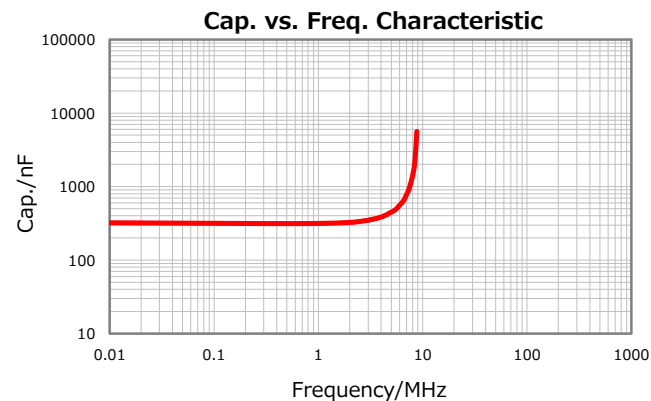
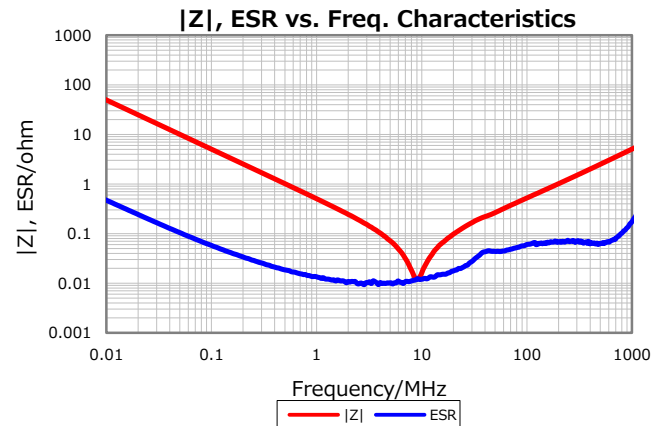

Characterization Sheet (Multilayer Ceramic Chip Capacitors)



⚠ All specifications are subject to change without notice.

June 28, 2020