

CGA6M1C0G3A392J200AE

TDK item description : CGA6M1C0G3A392JT***S



Equivalent C3225C0G3A392J for Automotive

Application & Main Feature

Automotive grade (Soft termination)

Series

CGA6(3225) [EIA 1210]

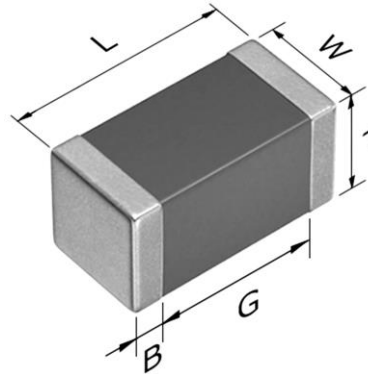

Dimensions

L	3.20+0.50,-0.40 mm
W	2.50±0.30 mm
T	2.00+0.30,-0.20 mm
B	0.20 mm min.
G	---

Temperature Characteristic

C0G (-55 to +125 degC, 0±30ppm/°C)

Rated Voltage

3A (1000Vdc)

Capacitance

3.9nF

Capacitance Tolerance

J (±5%)

Q

1,000 min.

Insulation Resistance

10000 Mohm min.

AEC-Q200

Yes

|Z|, ESR vs. Freq. Characteristics
(Simulation data)

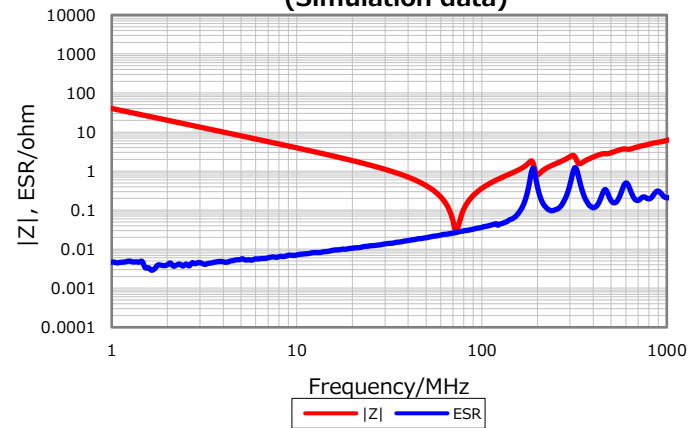

Cap. vs. Freq. Characteristic

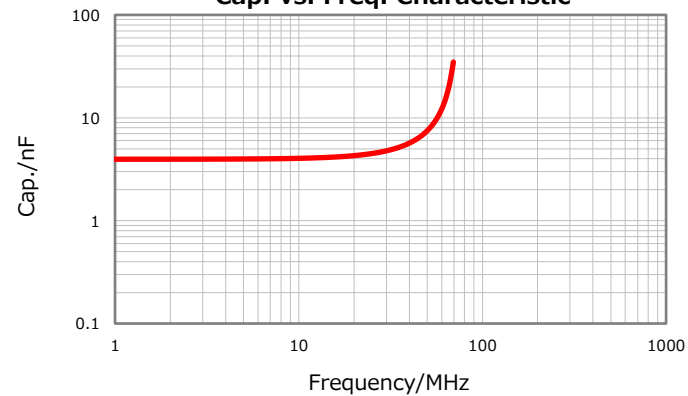

DC Bias Characteristic

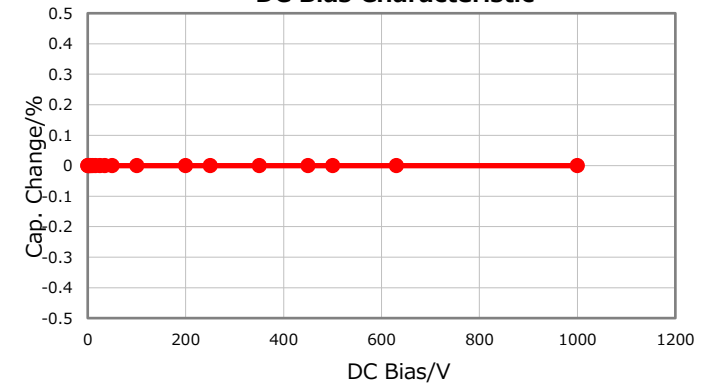

Temperature Characteristics

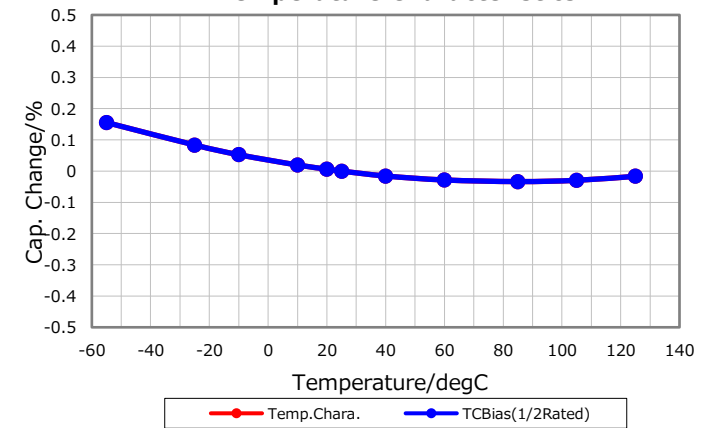

Ripple Temperature Rise Characteristics

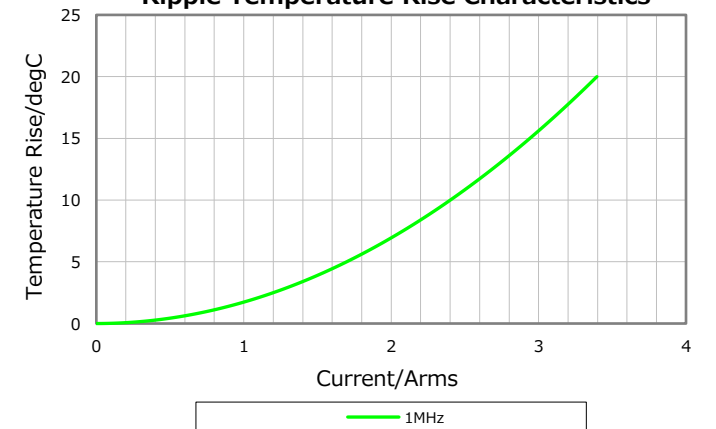

Characterization Sheet (Multilayer Ceramic Chip Capacitors)



All specifications are subject to change without notice.

April 7, 2023