

CGA6M3X8R2A474K200AE

TDK Item Description : CGA6M3X8R2A474KT***S



Equivalent C3225X8R2A474K for Automotive

Application & Main Feature

Automotive Grade (Soft Termination)

Series

CGA6(3225) [EIA CC1210]

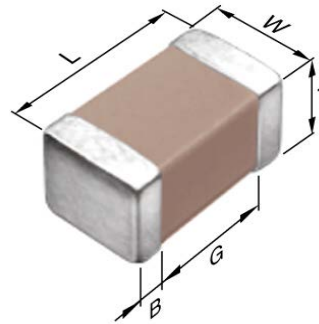

Dimensions

L	3.20mm +0.5,-0.4mm
W	2.50mm +/-0.3mm
T	2.00mm +0.3,-0.2mm
B	0.20mm Min.
G	

Temperature Characteristic

X8R (-55 to 150 degC +/-15%)

Rated Voltage

2A (100Vdc)

Capacitance

470nF

Capacitance Tolerance

K (+/-10%)

Dissipation Factor

3% Max.

Insulation Resistance

1.063Gohm Min

AEC-Q200

Yes

|Z|, ESR vs. Freq. Characteristics (Simulation Data)

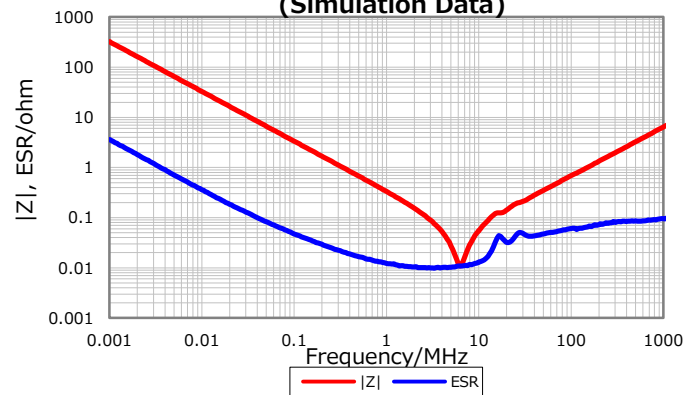

Cap. vs. Freq. Characteristic

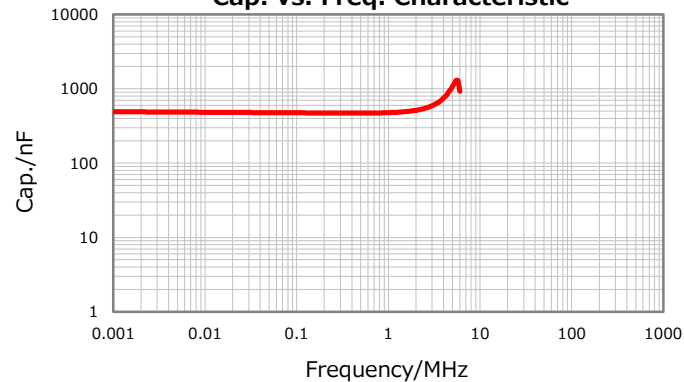

DC Bias Characteristic

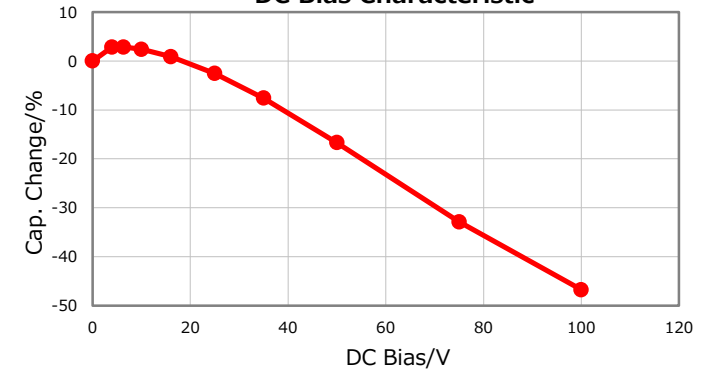

Temperature Characteristics

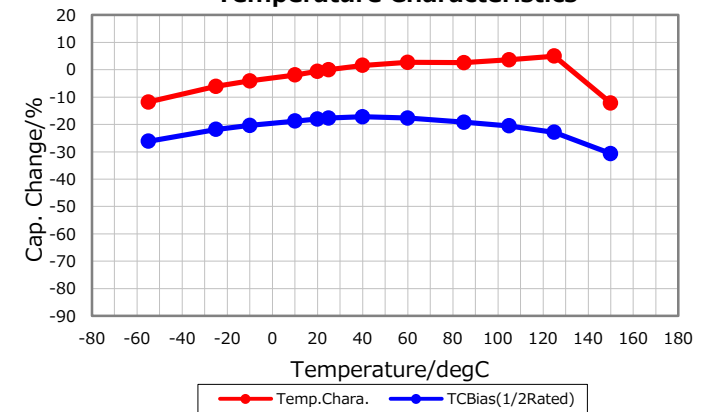

Ripple Temperature Rise Characteristics

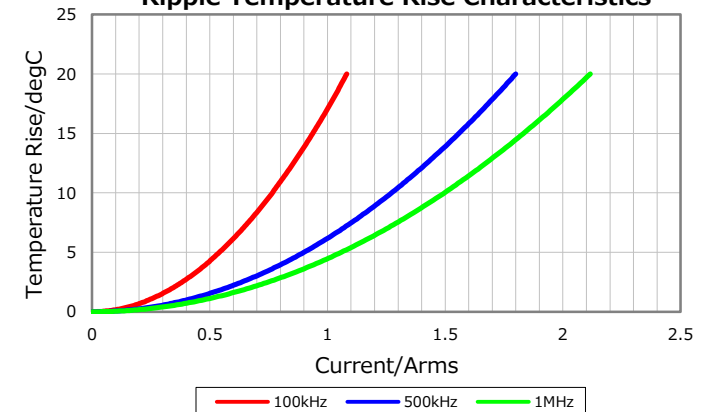

Characterization Sheet (Multilayer Ceramic Chip Capacitors)



All specifications are subject to change without notice.

March 17, 2017