

CGA7G1C0G3F150K110KA

TDK Item Description : CGA7G1C0G3F150KT****



Equivalent C4520C0G3F150K for Automotive

Application & Main Feature

Automotive Grade (High Voltage (1000V and over))

Series

CGA7(4520) [EIA CC1808]

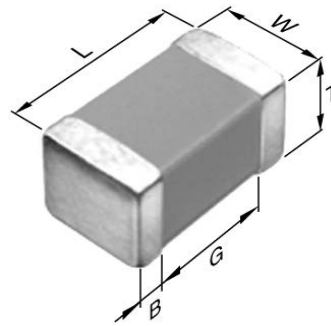

Dimensions

L 4.50mm +/-0.4mm
 W 2.00mm +/-0.2mm
 T 1.10mm +/-0.2mm
 B 0.20mm Min.
 G

Temperature Characteristic

C0G (-55 to 125 degC 0+/-30ppm/degC)

Rated Voltage

3F (3000Vdc)

Capacitance

15pF

Capacitance Tolerance

K (+/-10%)

Q Factor

700 Min.

Insulation Resistance

10Gohm Min.

AEC-Q200

Yes

|Z|, ESR vs. Freq. Characteristics

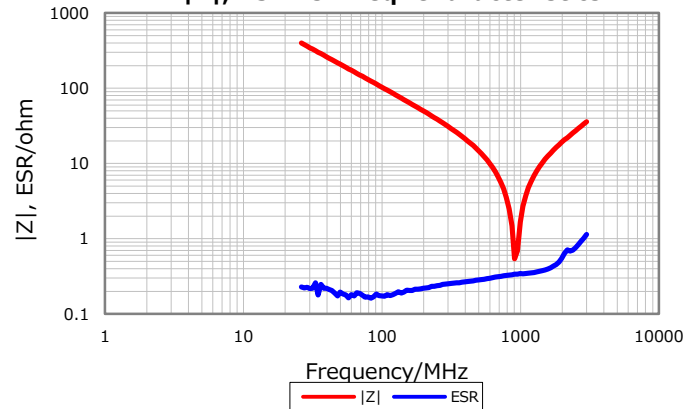

DC Bias Characteristic

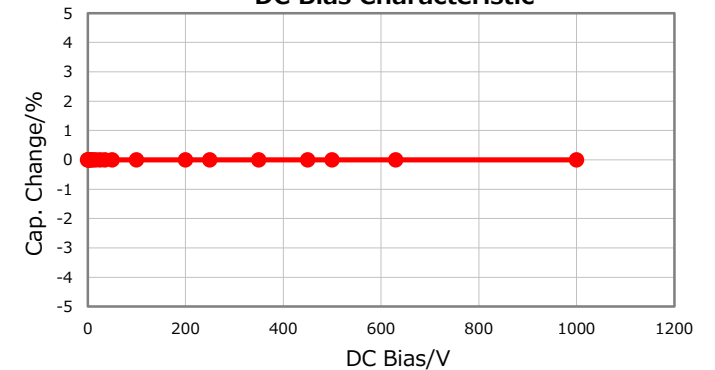

Cap. vs. Freq. Characteristic

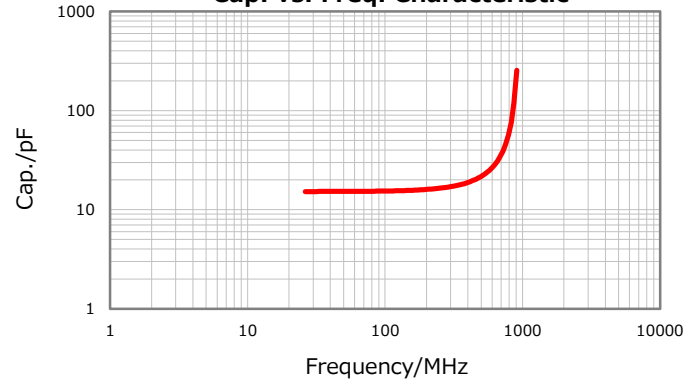

Temperature Characteristics

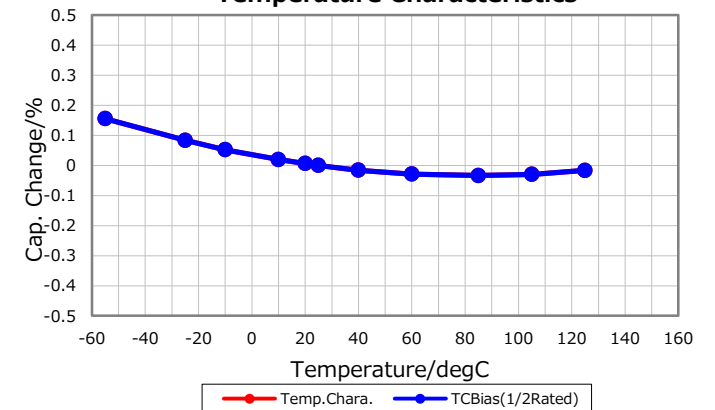

Characterization Sheet (Multilayer Ceramic Chip Capacitors)



All specifications are subject to change without notice.

March 23, 2018