

# CUS250M

# EVALUATION DATA

Template	260711 iss 2
DWG. No.	260910 iss 1

**Index**

1.	Evaluation Method.....	1
1.1	Circuit used for determination.....	1
	Circuit 1 used for determination .....	1
	Steady state data .....	1
	Over current protection (OCP) characteristics.....	1
	Over voltage protection (OVP) characteristics .....	1
	Output rise characteristics.....	1
	Output fall characteristics .....	1
	Hold up time characteristics .....	1
	Response to brownout characteristics .....	1
	Input current harmonics .....	1
	Input current .....	1
	Circuit 2 used for determination .....	1
	Dynamic load response characteristics .....	1
	Circuit 3 used for determination .....	2
	Inrush current waveform.....	2
	Circuit 4 used for determination .....	2
	Leakage current characteristics.....	2
	Circuit 5 used for determination .....	2
	Output ripple and noise waveform.....	2
	Configuration used for determination.....	3
	Electro-Magnetic interference characteristics.....	3
	(a) Conducted Emissions.....	3
	(b) Radiated Emissions.....	3
1.2	List of equipment used .....	4

2.	Characteristics.....	5
2.1	Steady state data.....	5
(1)	Regulation – line and load, temperature drift / Start up and Drop out voltage.....	5
(2)	Efficiency vs. Output current .....	6
(3)	Input current vs. Output current .....	7
(4)	Input power vs. Output current .....	8
(5)	Input power vs. Output current (Unit inhibited).....	9
2.2	Warm up voltage drift characteristics .....	10
2.3	Over current protection (OCP) characteristics .....	11
2.4	Over voltage protection (OVP) characteristics .....	11
2.5	Output rise characteristics.....	12
2.6	Output Fall Characteristics .....	13
2.7	Hold up time characteristics .....	14
2.8	Dynamic load response characteristics .....	15
2.9	Response to brownout characteristics .....	16
2.10	Inrush Current Waveform.....	17
2.11	Input current harmonics .....	18
2.12	Input current waveform .....	18
2.13	Leakage current characteristics.....	19
2.14	Output ripple and noise waveform.....	20
2.15	Electro-Magnetic Interference characteristics .....	21
	Conducted Emissions .....	21
2.16	Electro-Magnetic Interference characteristics .....	22
	Radiated Emissions.....	22

Terminology Used:

	Definition
V <sub>in</sub> .....	Input voltage
V <sub>out</sub> .....	Output voltage
I <sub>in</sub> .....	Input current
I <sub>out</sub> .....	Output current
T <sub>a</sub> .....	Ambient temperature
F .....	Frequency

TDK Lambda UK Ltd.  
Kingsley Avenue  
Ilfracombe  
Devon, EX34 8ES  
United Kingdom

Website: <https://uk.tdk-lambda.com>

# 1. Evaluation Method

## 1.1 Circuit used for determination

### Circuit 1 used for determination

- Steady state data
- Over current protection (OCP) characteristics
- Over voltage protection (OVP) characteristics
- Output rise characteristics
- Output fall characteristics
- Hold up time characteristics
- Response to brownout characteristics
- Input current harmonics
- Input current

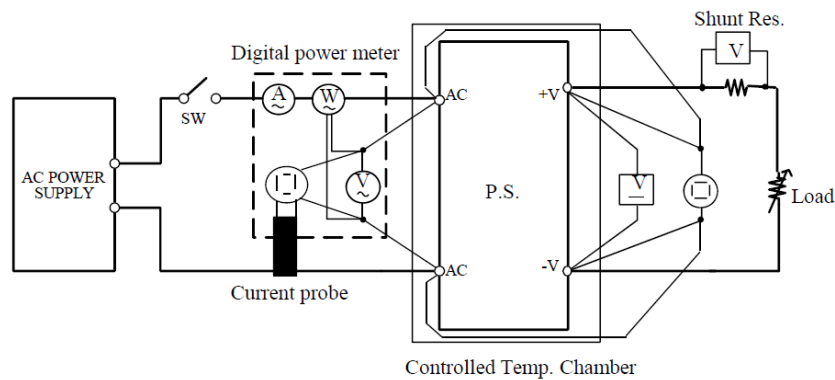

### Circuit 2 used for determination

Dynamic load response characteristics

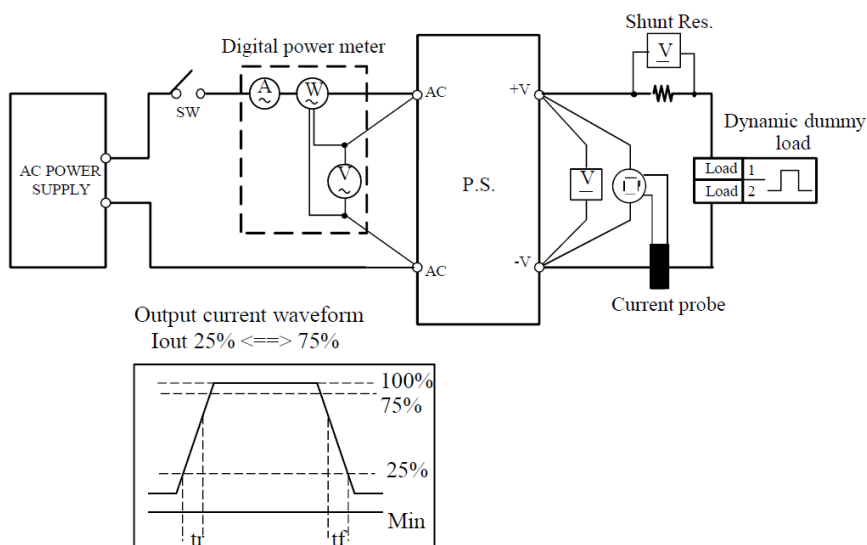

**Circuit 3 used for determination**

Inrush current waveform

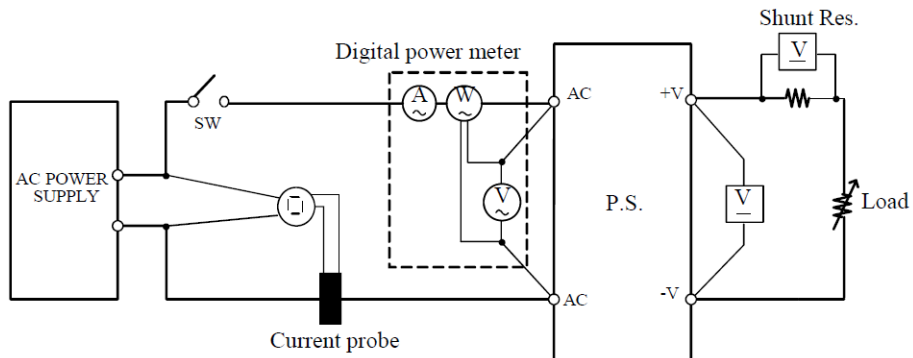

**Circuit 4 used for determination**

Leakage current characteristics

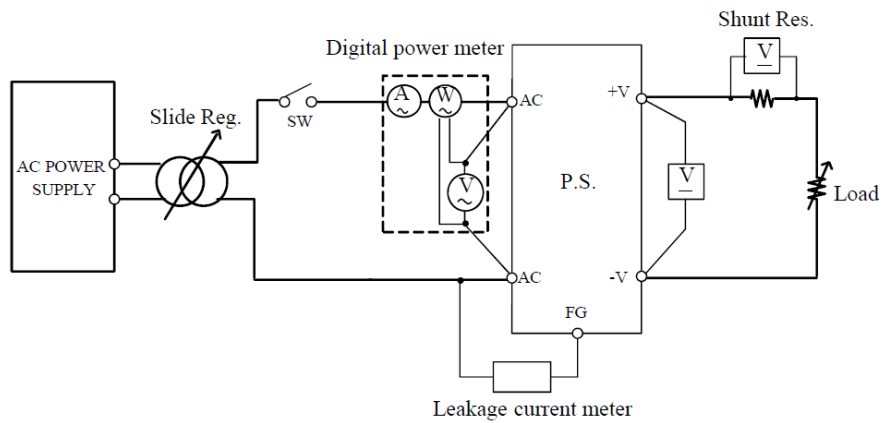

**Circuit 5 used for determination**

Output ripple and noise waveform

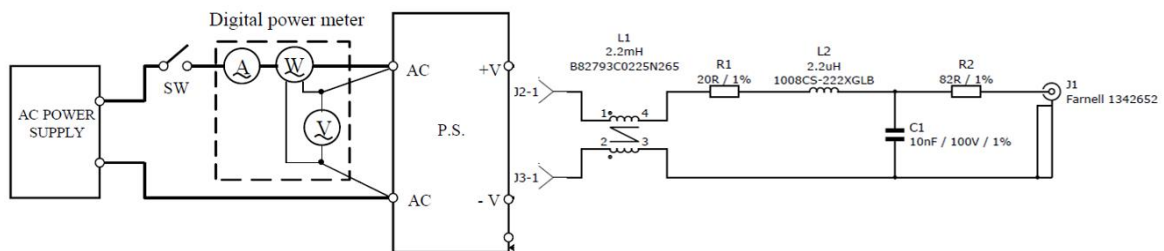

**Configuration used for determination**

Electro-Magnetic interference characteristics

(a) Conducted Emissions

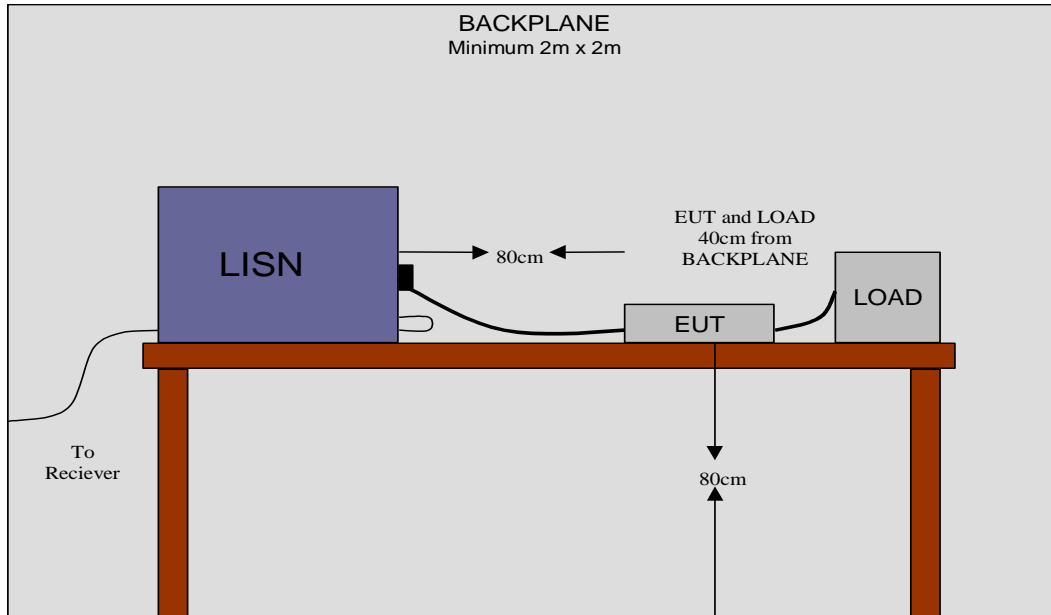

(b) Radiated Emissions

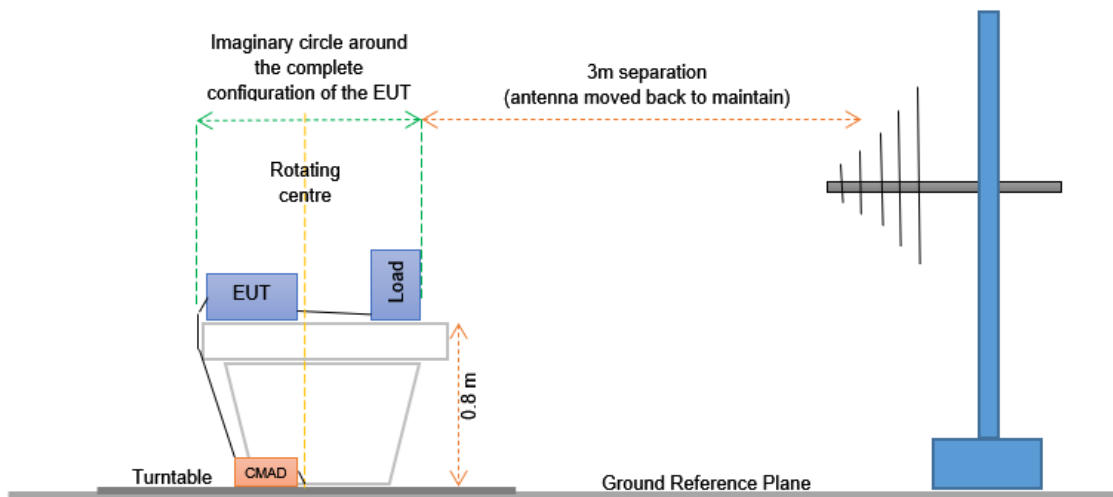

**1.2 List of equipment used**

1.3

	Equipment Used	Manufacturer	Model No.
1	Thermal Chamber	Thermotron	SE-300-2-2
2	AC Source	Chroma	61505
3	Power Analyser	Vitrek	PA900
4	Chroma Mainframe	Chroma	63334A
5	Chroma Mainframe	Chroma	63334A
6	Oscilloscope	Rhode & Schwarz	RTM3004
7	Current Probe	Agilent	1146B
8	Current Probe	Agilent	1146B
9	Differential Probe	Keysight	N2791A
10	RF Receiver	Rhode & Schwarz	ESR 17
11	LISN	Rhode & Schwarz	ESH3-Z5
12	Pulse Limiter	Rhode & Schwarz	ESH3-Z2
13	Cable		EMI-RF-5
14	Cable		EMI-RF-6
15	RF Receiver	Rhode & Schwarz	ESR 16
16	Antenna	Schwarzbeck-Mess	VULB 9166
17	Antenna Mast	Maturo	AM 4.0
18	Turntable	Maturo	TT 2.0 SI
19	Control Unit	Maturo	MCU
20	Semi-Anechoic Chamber	TRS	3m SAC
21	CMAD	Chase	CEC-8110
22	Cable		EMI-RF-1
23	Cable		EMI-RF-2
24	Cable		EMI-RF-3
25	Cable		EMI-RF-8
26	Leak Current HiTester	Hioki	ST5541

## 2. Characteristics

### 2.1 Steady state data

#### (1) Regulation – line and load, temperature drift / Start up and Drop out voltage

CUS250M-12

1 Regulation – line and load

Condition

Ta: 25°C

Iout \ Vin	85Vac	110Vac	230Vac	264Vac	Line Regulation	
0%	12.016	12.017	12.017	12.016	1mV	0.01%
50%	12.011	12.004	12.004	12.005	7mV	0.06%
100%	11.996	11.991	11.991	11.992	3mV	0.03%
Load Regulation	20mV	26mV	26mV	24mV		
	0.16%	0.22%	0.22%	0.20%		

2 Temperature drift

Condition

Vin: 240Vac

Iout: 100%

Ta	-30°C	25°C	55°C	Temperature Stability	
12.000	11.976V	11.992V	11.976V	16mV	0.133%

3 Start-up voltage and Dropout voltage

Condition

Ta: 25°C

Iout: 100%

Start-up voltage (Vin)	74Vac
Dropout Voltage (Vin)	74Vac



# CUS250M

## (2) Efficiency vs. Output current

Conditions:  $V_{in}$  : 85Vac     $\diamond$  85Vac  
                  : 115Vac     $\square$  115Vac  
                  : 230Vac     $\blacktriangle$  230Vac  
                  : 264Vac     $\times$  264Vac  
 $T_a$  : 25°C

CUS250M-12

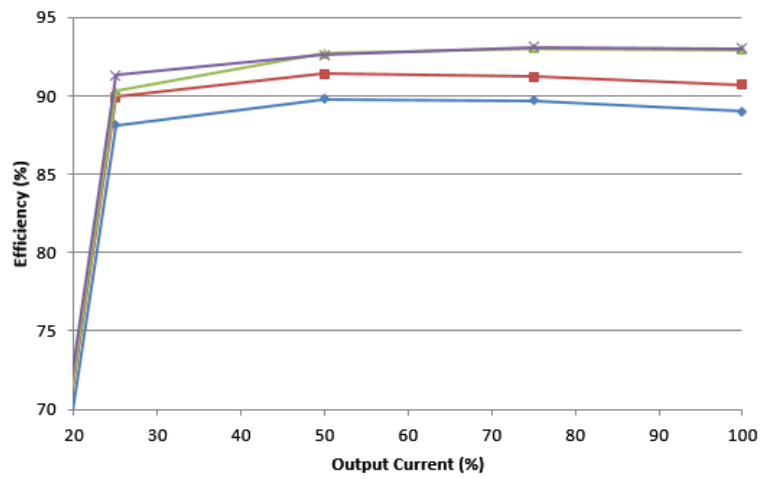

# CUS250M

## (3) Input current vs. Output current

Conditions: Vin : 85Vac  
                  : 115Vac  
                  : 230Vac  
                  : 264Vac  
                  Ta : 25°C

◆ 85Vac  
■ 115Vac  
▲ 230Vac  
× 264Vac

CUS250M-24

Vin	Input Current				
	Iout: 0%	Iout: 25%	Iout: 50%	Iout: 75%	Iout: 100%
85Vac	0.03A	0.57A	1.37A	2.05A	2.76A
115Vac	0.03A	0.54A	1.30A	1.94A	2.60A
230Vac	0.04A	0.30A	0.65A	0.95A	1.25A
264Vac	0.04A	0.28A	0.59A	0.85A	1.12A

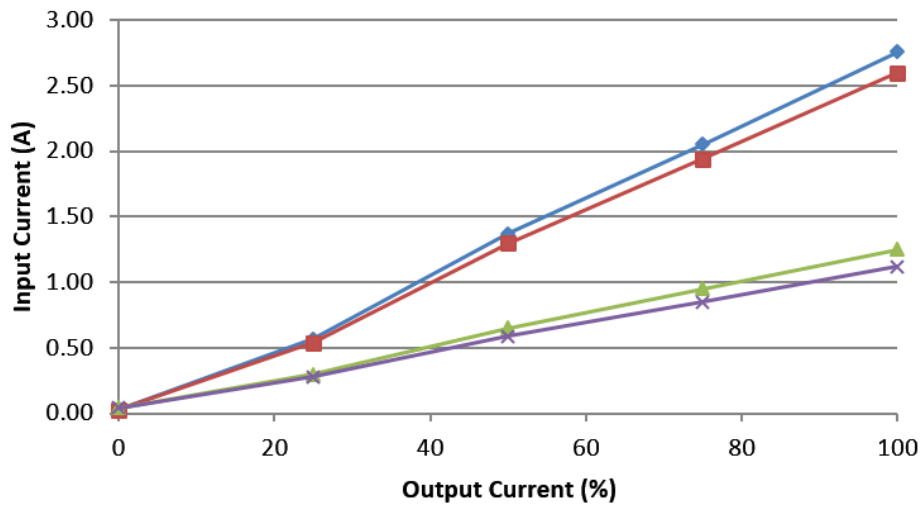

# CUS250M

## (4) Input power vs. Output current

Conditions: Vin : 85Vac     ◆ 85Vac  
                  : 115Vac     ■ 115Vac  
                  : 230Vac     ▲ 230Vac  
                  : 264Vac     ✕ 264Vac  
                  Ta : 25°C

CUS250M-24

Vin	Input Power				
	Iout: 0%	Iout: 25%	Iout: 50%	Iout: 75%	Iout: 100%
85Vac	1.0W	47.1W	115.2W	172.2W	231.3W
115Vac	1.0W	57.3W	140.4W	210.2W	282.1W
230Vac	0.7W	57.4W	138.2W	205.9W	274.9W
264Vac	0.7W	56.3W	138.4W	205.7W	274.5W

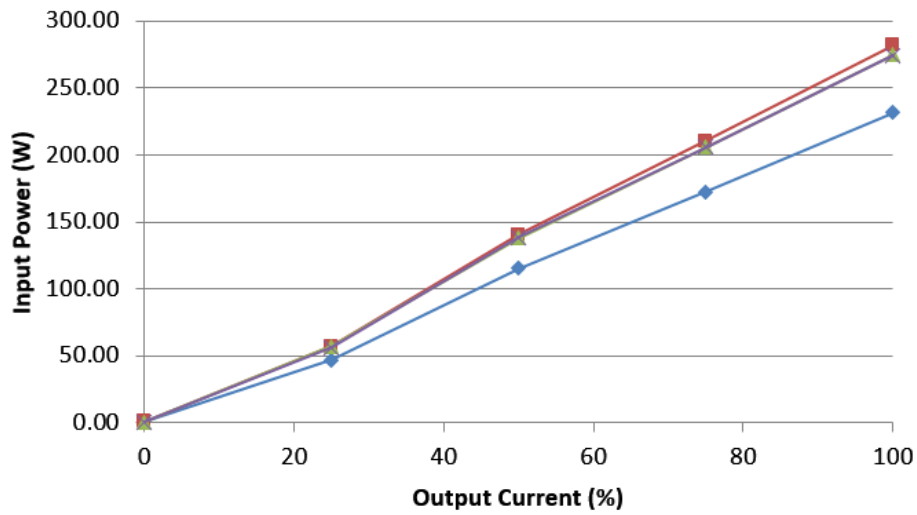

# CUS250M

## (5) Input power vs. Output current (Unit inhibited)

Conditions: Vin : 85Vac  
 : 115Vac  
 : 230Vac  
 : 264Vac  
 Ta : 25°C

—◆— 85Vac  
 —■— 115Vac  
 —▲— 230Vac  
 —×— 264Vac

CUS250M-12

Vin	Input Power (Standby Channel)				
	Iout : 0%	Iout: 25%	Iout: 50%	Iout: 75%	Iout: 100%
85Vac	0.2W	0.4W	0.7W	0.9W	1.1W
115Vac	0.2W	0.4W	0.7W	0.9W	1.1W
230Vac	0.3W	0.5W	0.8W	1.1W	1.3W
264Vac	0.3W	0.6W	0.9W	1.2W	1.4W

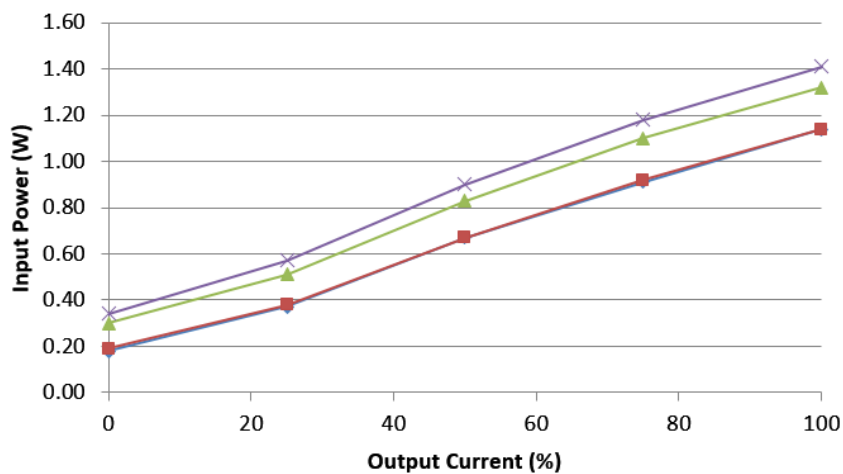

## 2.2 Warm up voltage drift characteristics

Conditions:  $V_{in}$ : 230Vac  
 $I_{out}$ : 100%  
 $T_a$ : 25°C

CUS250M-12

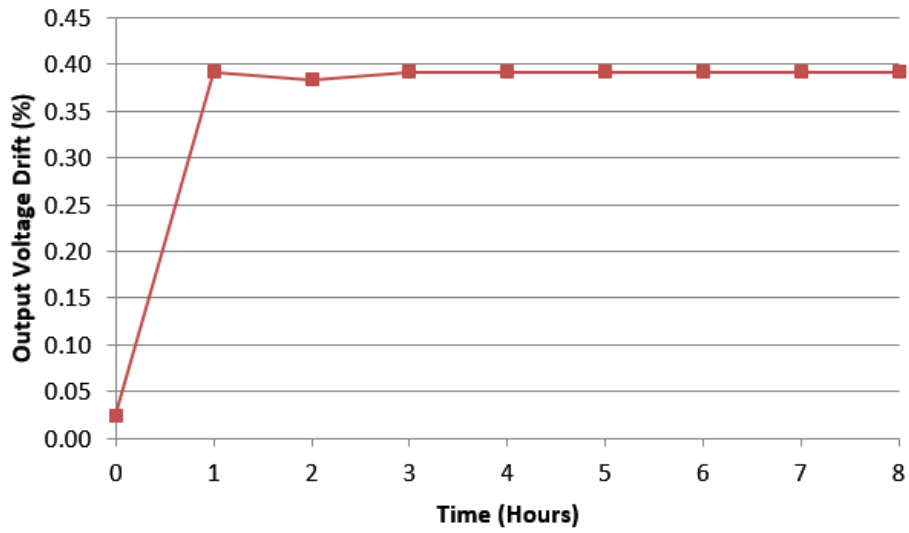

## 2.3 Over current protection (OCP) characteristics

Conditions: Vin: 110Vac

Ta: -30°C

25°C

60°C

— -30°C

— 25°C

— 60°C

CUS250M-12

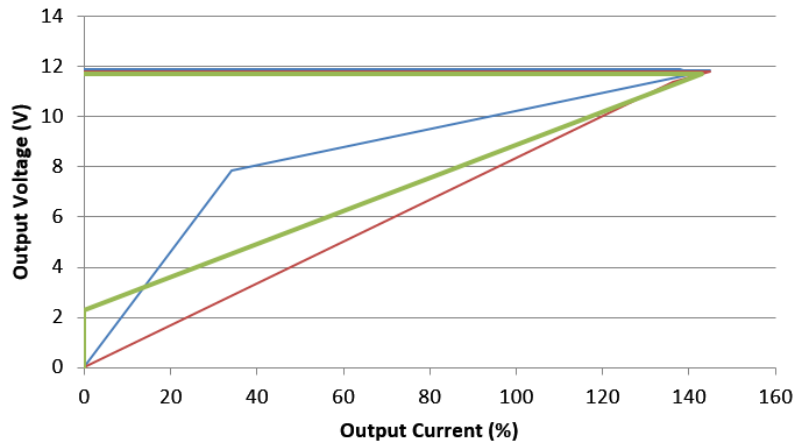

## 2.4 Over voltage protection (OVP) characteristics

Conditions: Vin: 100Vac

Iout: 100%

Ta: 25°C

CUS250M-12

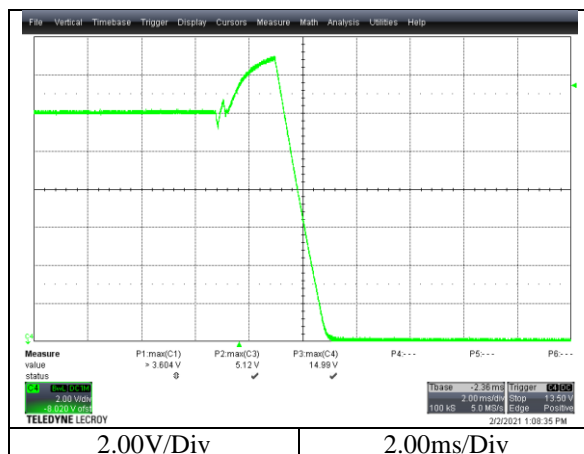

## 2.5 Output rise characteristics

Conditions: Vin: 85Vac  
 : 115Vac  
 : 230Vac  
 : 264Vac  
 Ta: 25°C  
 Iout: 0%  
 : 100%

CUS250M-12

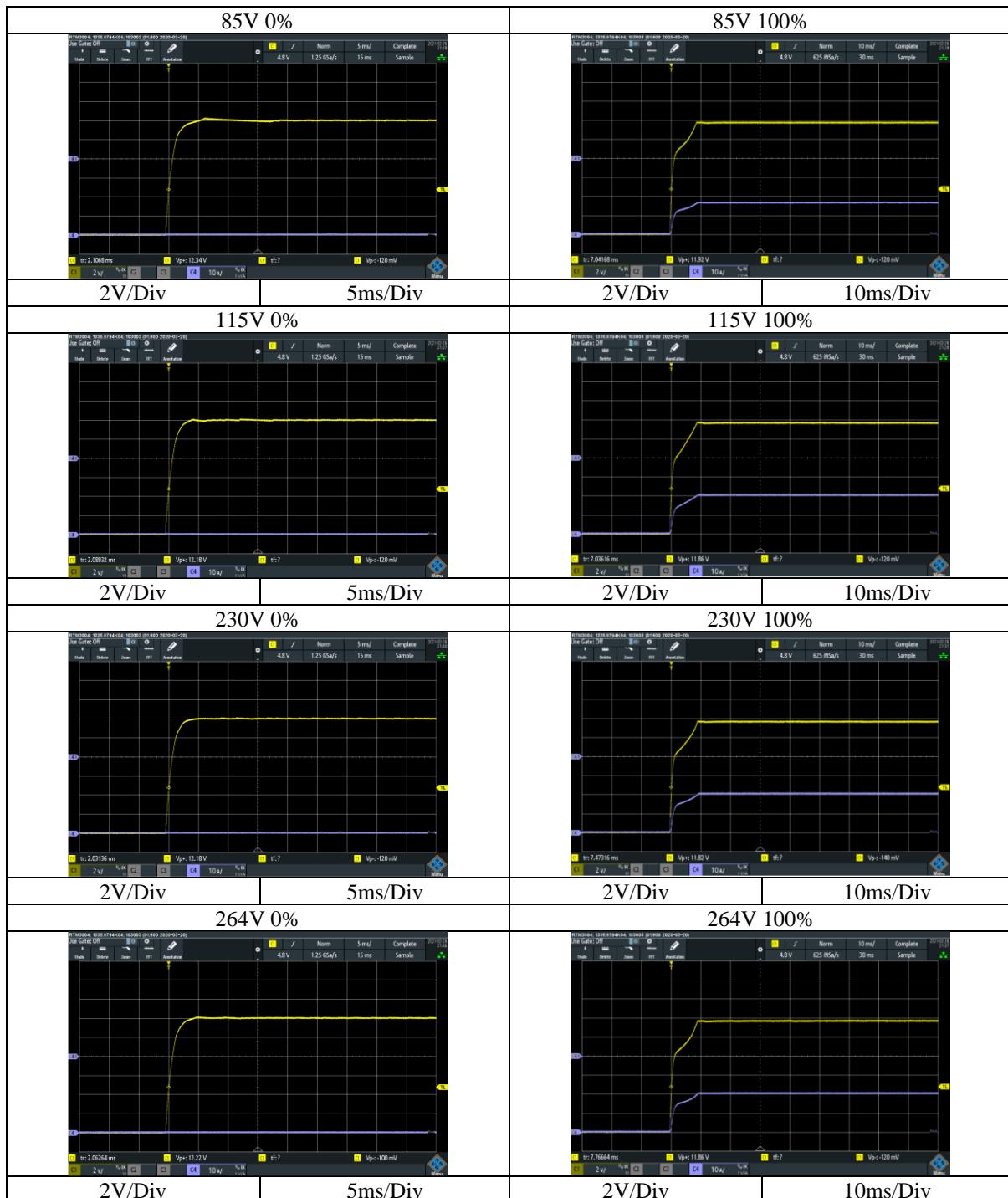

## 2.6 Output Fall Characteristics

Conditions: Vin: 85Vac  
 : 115Vac  
 : 230Vac  
 : 264Vac  
 Ta: 25°C  
 Iout: 0%  
 : 100%

CUS250M-12

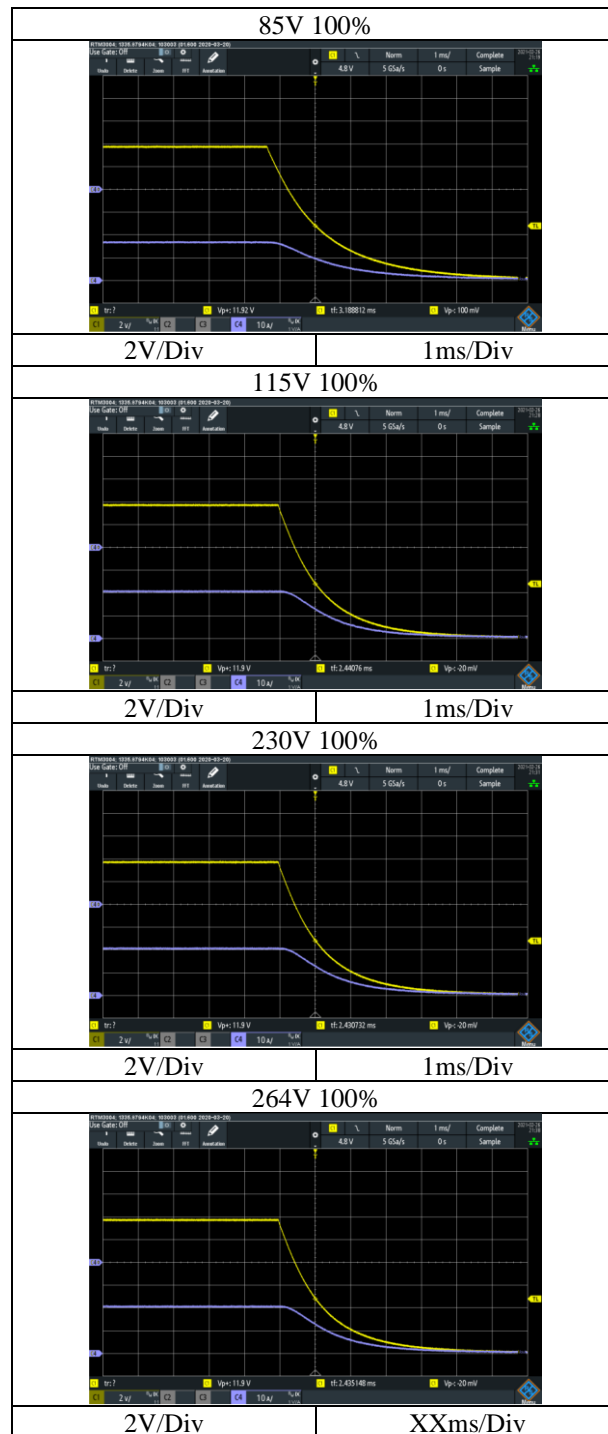



# CUS250M

## 2.7 Hold up time characteristics

Conditions: Vin: 115Vac  
: 230Vac  
Ta: 25°C

CUS250M-12

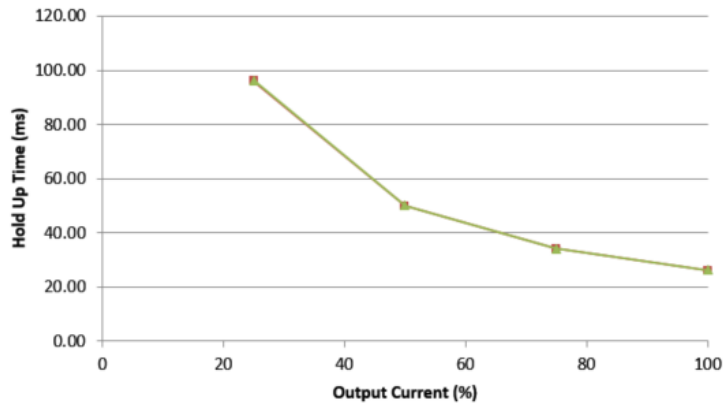

## 2.8 Dynamic load response characteristics

Conditions: Vin: 100Vac  
 264Vac  
 Ta: 25°C  
 Iout: 25% ↔ 75%  
 (tr = tf = 50μS)  
 f : 10Hz  
 : 100Hz

CUS250M-12

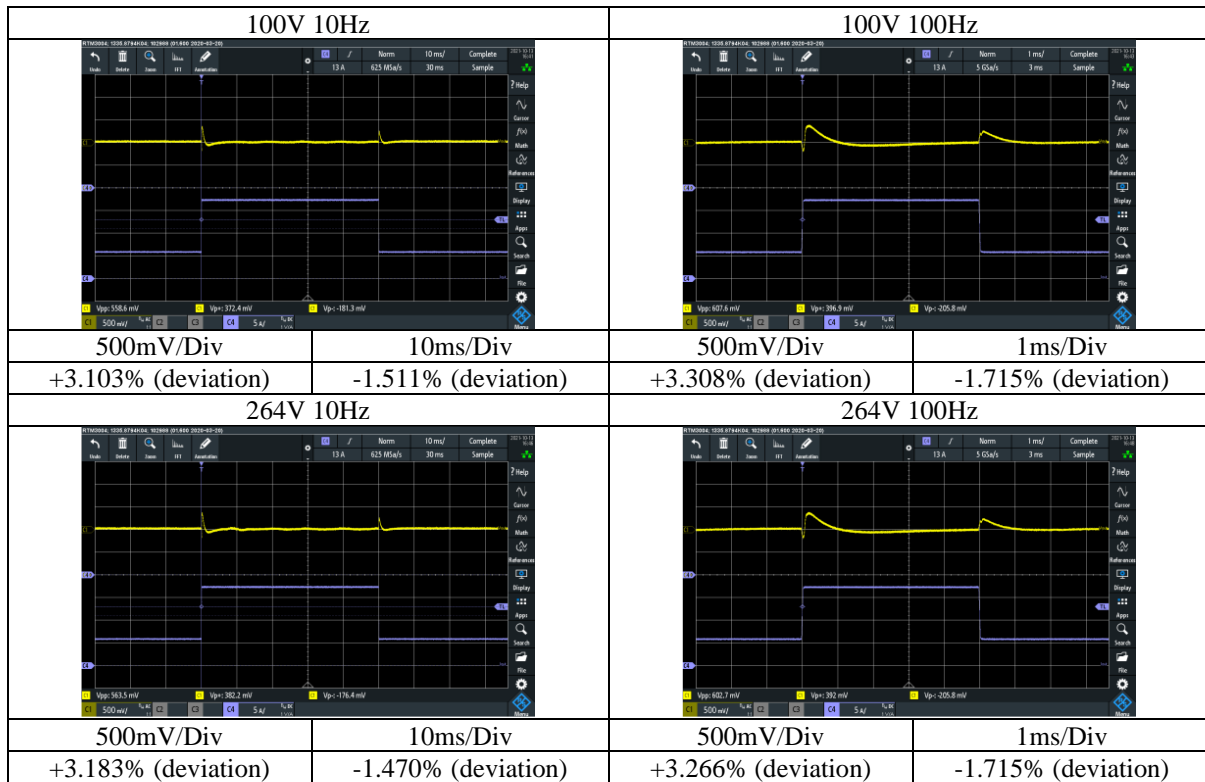

## 2.9 Response to brownout characteristics

Conditions: Vin: 110Vac  
Iout: 100%  
Ta: 25°C

CUS250M-12

Performance parameters: A - The shortest interruption time for the output to drop below the regulation band  
B – The interruption time for the output to drop down to 20 – 40 % of nominal  
C – The interruption time for the output to drop down to <20% of nominal

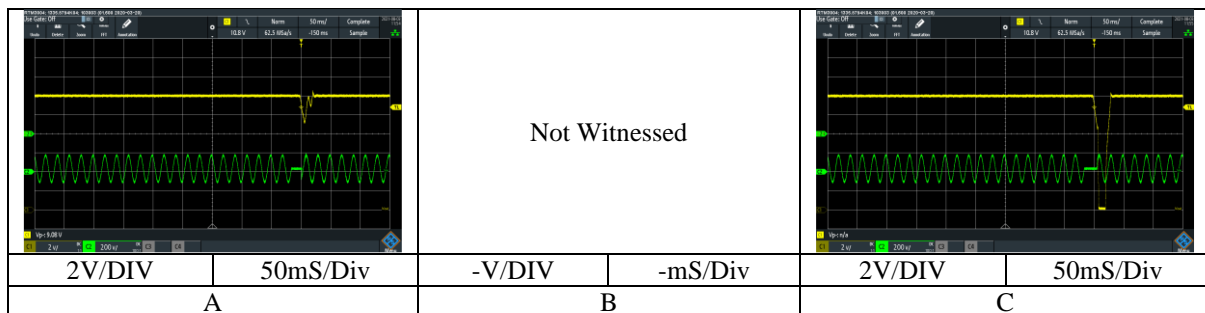

Conditions: Vin: 230Vac  
Iout: 100%  
Ta: 25°C

CUS250M-12

Performance parameters: A - The shortest interruption time for the output to drop below the regulation band  
B – The interruption time for the output to drop down to 20 – 40 % of nominal  
C – The interruption time for the output to drop down to <20% of nominal

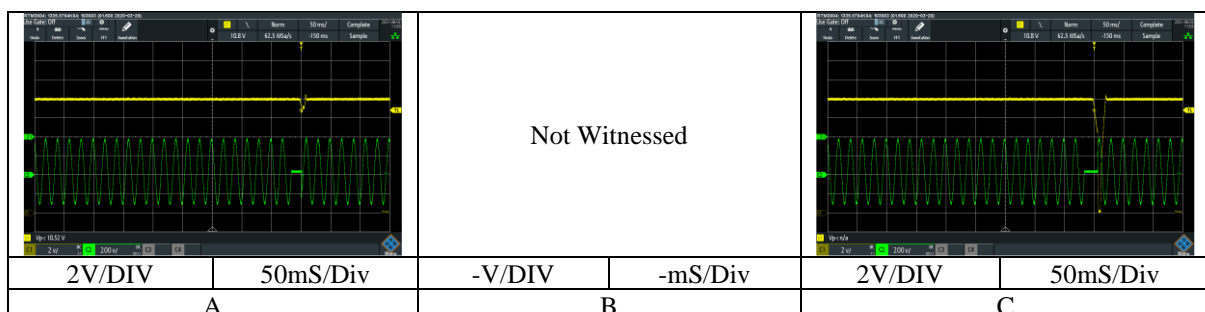

## 2.10 Inrush Current Waveform

Conditions: Vin: 230Vac  
Iout: 100%  
Ta: 25°C

CUS250M-12

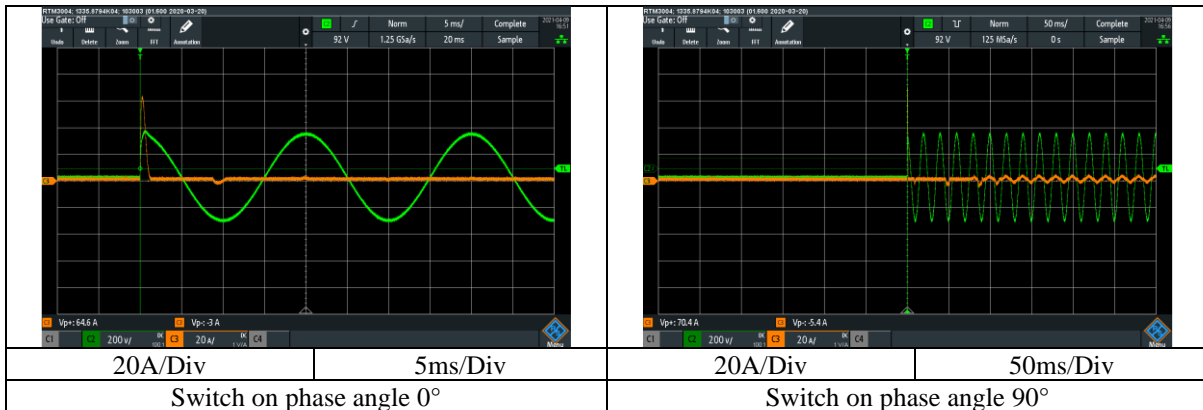

Conditions: Vin: 264Vac  
Iout: 100%  
Ta: 25°C

CUS250M-12

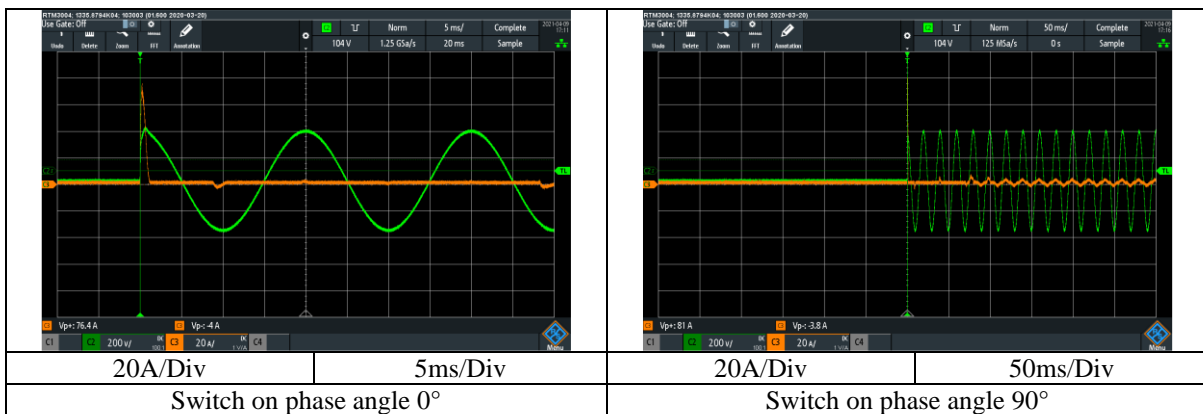

## 2.11 Input current harmonics

Conditions: Vin: 110Vac  
Iout: 100%  
Ta: 25°C

CUS250M-12

### Class A Current Harmonics (Average Measurements)

110Vac @ 50Hz; 100% Load

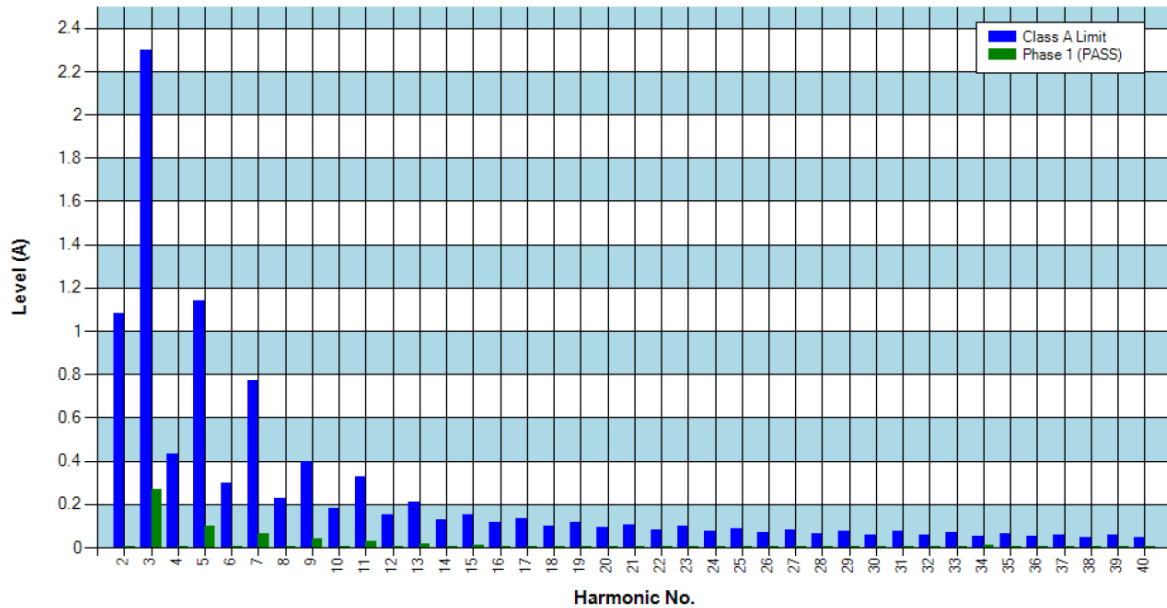

## 2.12 Input current waveform

Conditions: Iout: 100%  
Ta: 25°C

CUS250M-12

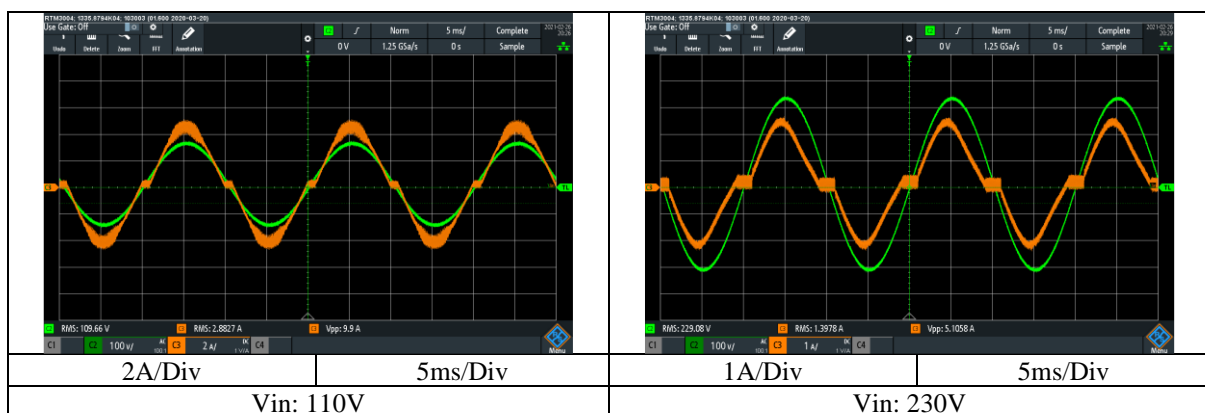

2.13 Leakage current characteristics

Conditions: Iout: 0%  
Iout: 100%  
Ta: 25°C

CUS250M-12

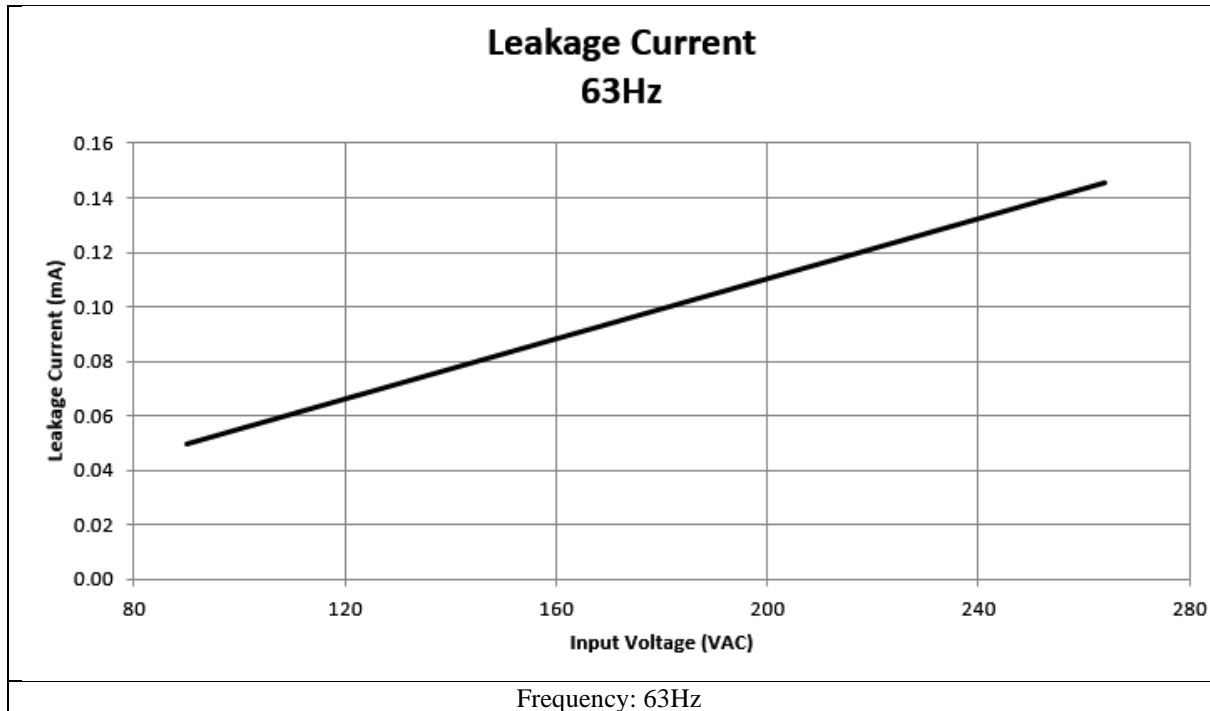

## 2.14 Output ripple and noise waveform

Conditions: Vin: 100Vac  
Iout: 0%  
Ta: 25°C

CUS250M-12

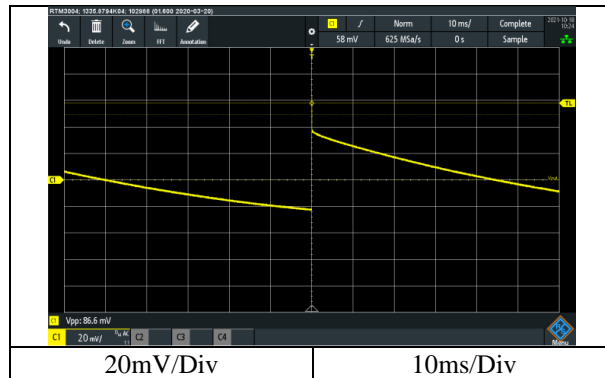

Conditions: Vin: 115Vac  
Iout: 100%  
Ta: 25°C

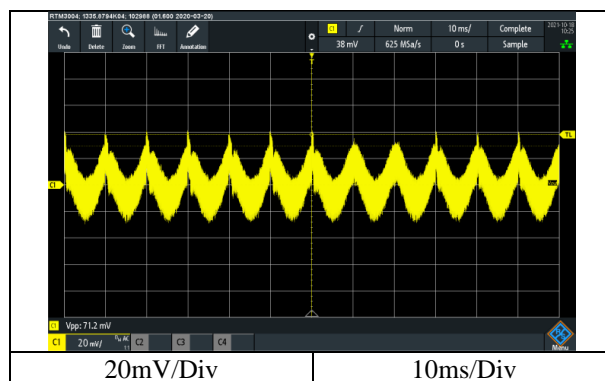

## 2.15 Electro-Magnetic Interference characteristics

### Conducted Emissions

Conditions: Vin: 230Vac

Iout: 100%

Ta: 25°C

QP Limit: —

AVE Limit: —

CUS250M-12

Live

Point A (0.55MHz)		
Ref Data	Limit (dBμV)	Measure (dBμV)
QP	56.00	48.49
AVE	46.00	32.88

Neutral

Point B (0.55MHz)		
Ref Data	Limit (dBμV)	Measure (dBμV)
QP	56.00	49.76
AVE	46.00	33.01

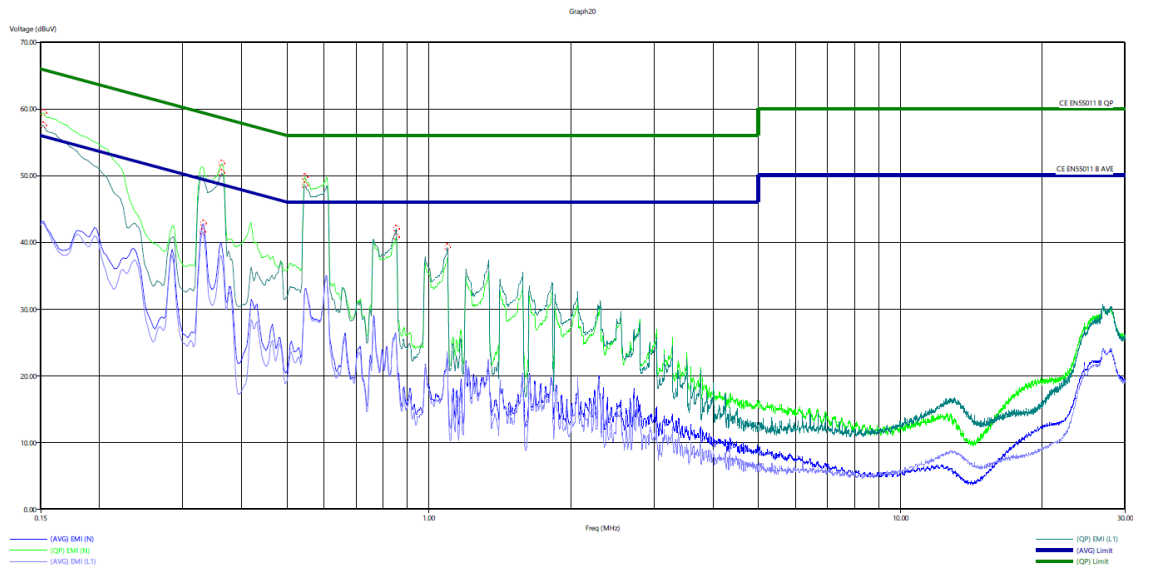



## 2.16 Electro-Magnetic Interference characteristics

### Radiated Emissions

Conditions: Vin: 230Vac

Iout: 100%

Ta: 25°C

Horizontal: —

Vertical: —

CUS250M-12

Point A (31.2MHz)		
Ref Data	Limit (dB $\mu$ V/m)	Measure (dB $\mu$ V/m)
QP	40.00	25.05

