

# **CUS350MP-1000**

## **EVALUATION DATA**

## INDEX

	PAGE
<b>1. Evaluation Method</b>	
1-1. Circuit used for determination .....	4
Circuit 1 used for determination	
Steady state data	
Warm up voltage drift characteristics	
Hold up time characteristics	
Output rise characteristics	
Output fall characteristics	
Over current protection (OCP) characteristics	
Over voltage protection (OVP) characteristics	
Response to brown out characteristics	
Input current waveform	
Circuit 2 used for determination .....	4
Dynamic load response characteristics	
Circuit 3 used for determination .....	5
Inrush current waveform	
Circuit 4 used for determination .....	5
Leakage current characteristics	
Circuit 5 used for determination .....	6
Output ripple and noise waveform	
Circuit 6 used for determination .....	6
Output rise and fall characteristics with ON/OFF control	
Configuration used for determination .....	7
Electro-Magnetic Interference characteristics	
(a) Conducted Emission	
(b) Radiated Emission	
1-2. List of equipment used .....	8
1-3. Load condition .....	8

2. Characteristics

	PAGE
2-1. Steady state data	
(1) Line and load regulation, Temperature drift, Start up voltage and Drop out voltage	9-10
(2) Ripple noise voltage vs. Input voltage	11
(3) Efficiency and Power factor vs. Output current	12
(4) Input power vs. Output current	13
(5) Input current vs. Output current	14
2-2. Warm up voltage drift characteristics	15
2-3. Hold up time characteristics	15
2-4. Output rise characteristics	16-17
2-5. Output fall characteristics	18-19
2-6. Output rise and fall characteristics with ON/OFF Control	20-21
2-7. Over current protection (OCP) characteristics	22
2-8. Over voltage protection (OVP) characteristics	22
2-9. Dynamic load response characteristics	23-28
2-10. Response to brown out characteristics	29-30
2-11. Inrush current waveform	31
2-12. Input current harmonics	32
2-13. Input current waveform	32
2-14. Leakage current characteristics	33
2-15. Output ripple and noise waveform	34-35
2-16. Electro-Magnetic Interference characteristics	36-41

Terminology used

	Definition
V <sub>in</sub>	Input voltage
V <sub>out</sub>	Output voltage
I <sub>in</sub>	Input current
I <sub>out</sub>	Output current
T <sub>a</sub>	Ambient temperature
f	Frequency
V <sub>stb</sub>	STB output voltage
I <sub>stb</sub>	STB output current

※ Test results are reference data based on our measurement condition.

# 1. Evaluation Method

## 1-1. Circuit used for determination

### Circuit 1 used for determination

- Steady state data
- Warm up voltage drift characteristics
- Hold up time characteristics
- Output rise characteristics
- Output fall characteristics
- Over current protection (OCP) characteristics
- Over voltage protection (OVP) characteristics
- Response to brown out characteristics
- Input current waveform

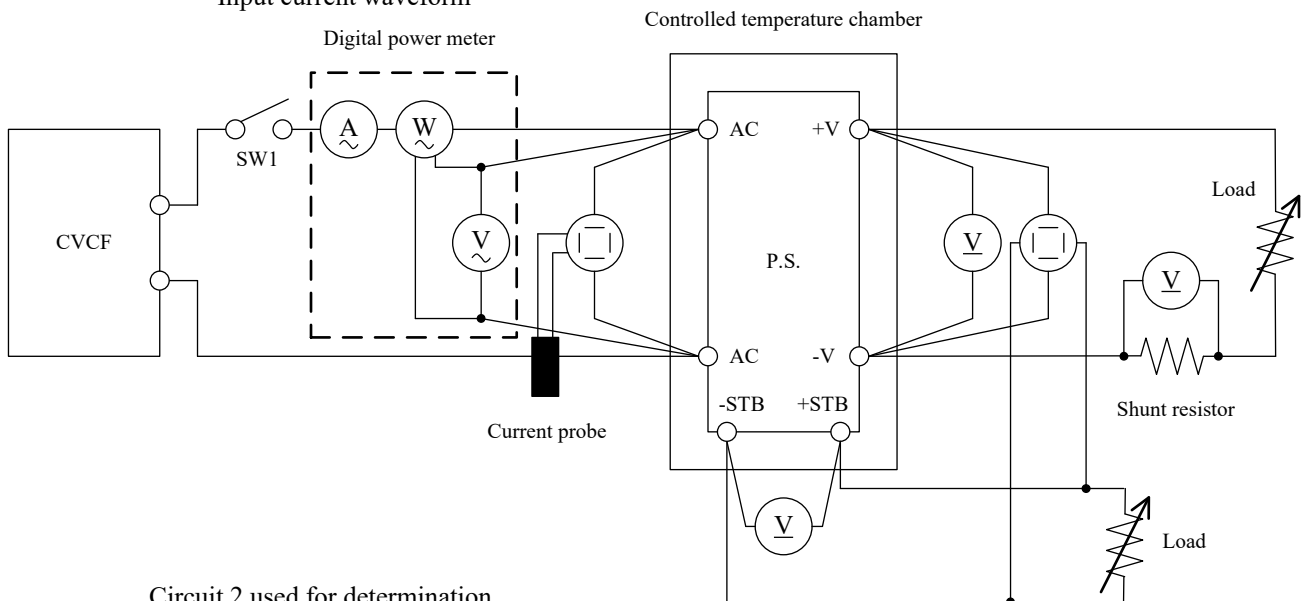

### Circuit 2 used for determination

- Dynamic load response characteristics

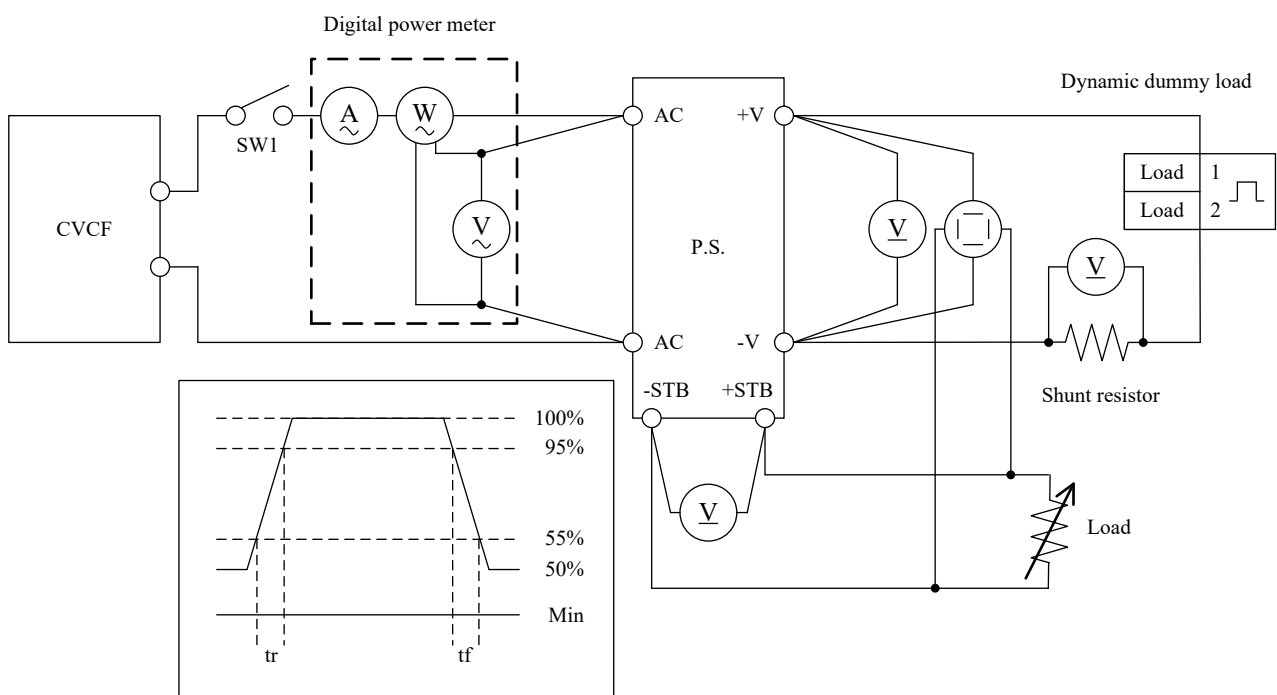

Circuit 3 used for determination

- Inrush current waveform

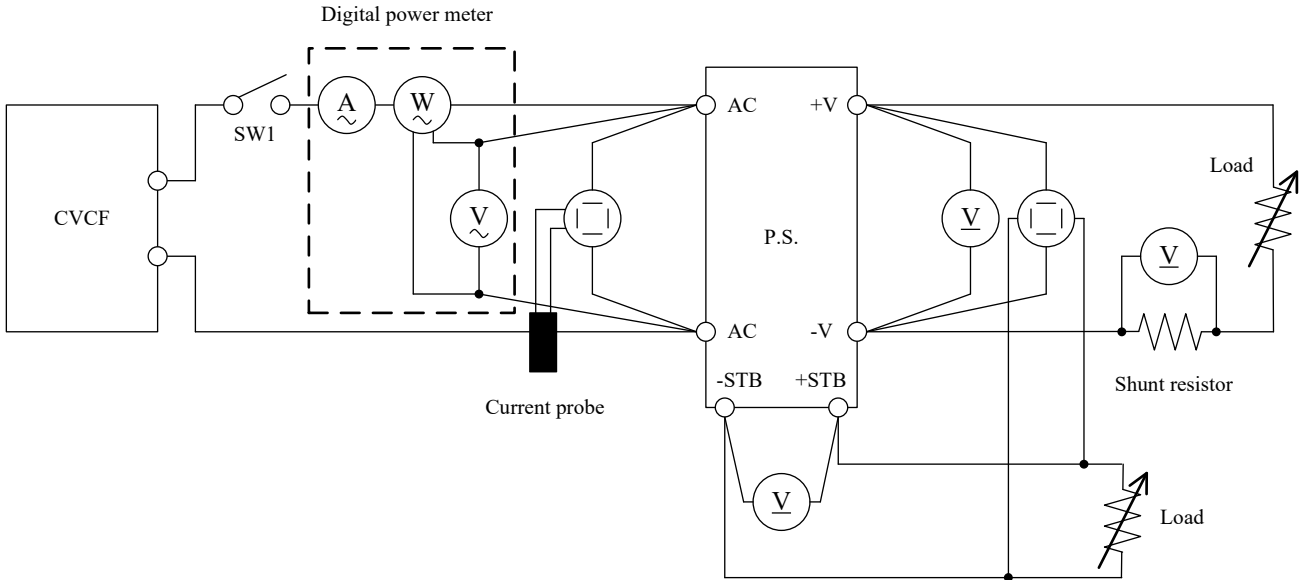

Circuit 4 used for determination

- Leakage current characteristics

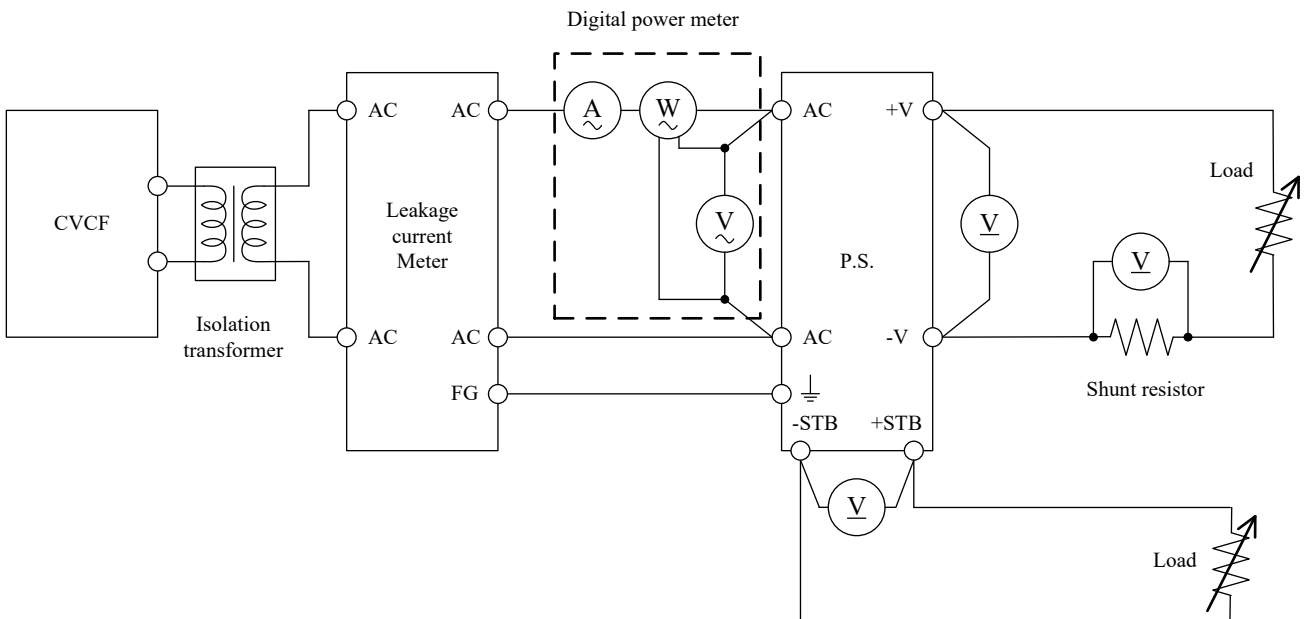

Circuit 5 used for determination

- Output ripple and noise waveform

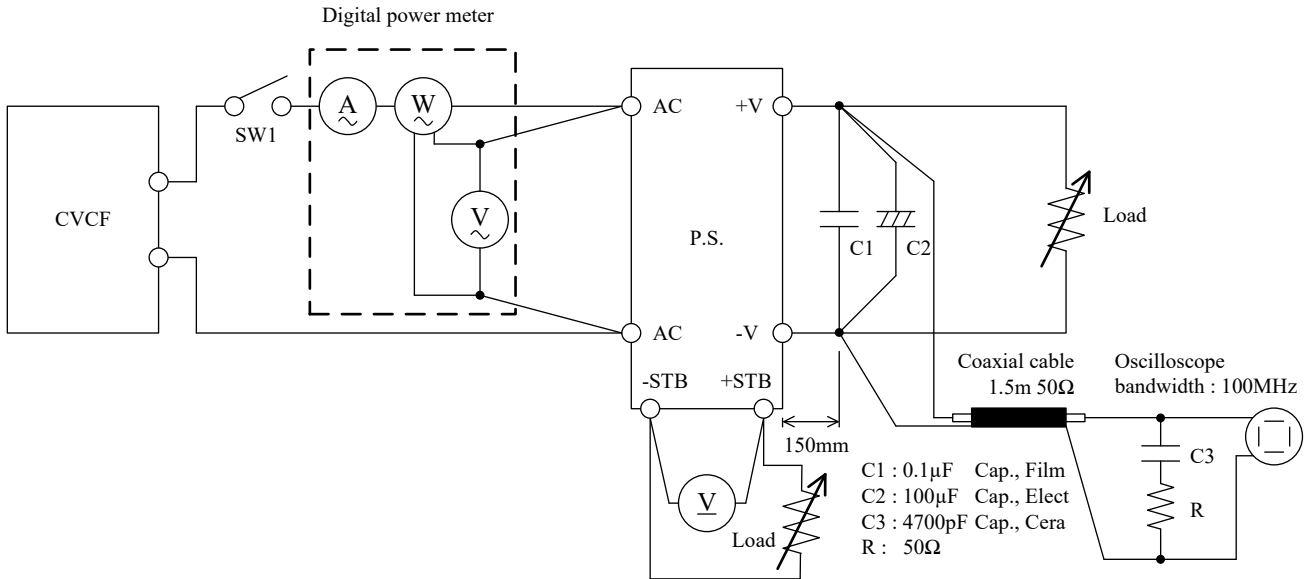

Circuit 6 used for determination

- Output rise and fall characteristics with ON/OFF Control

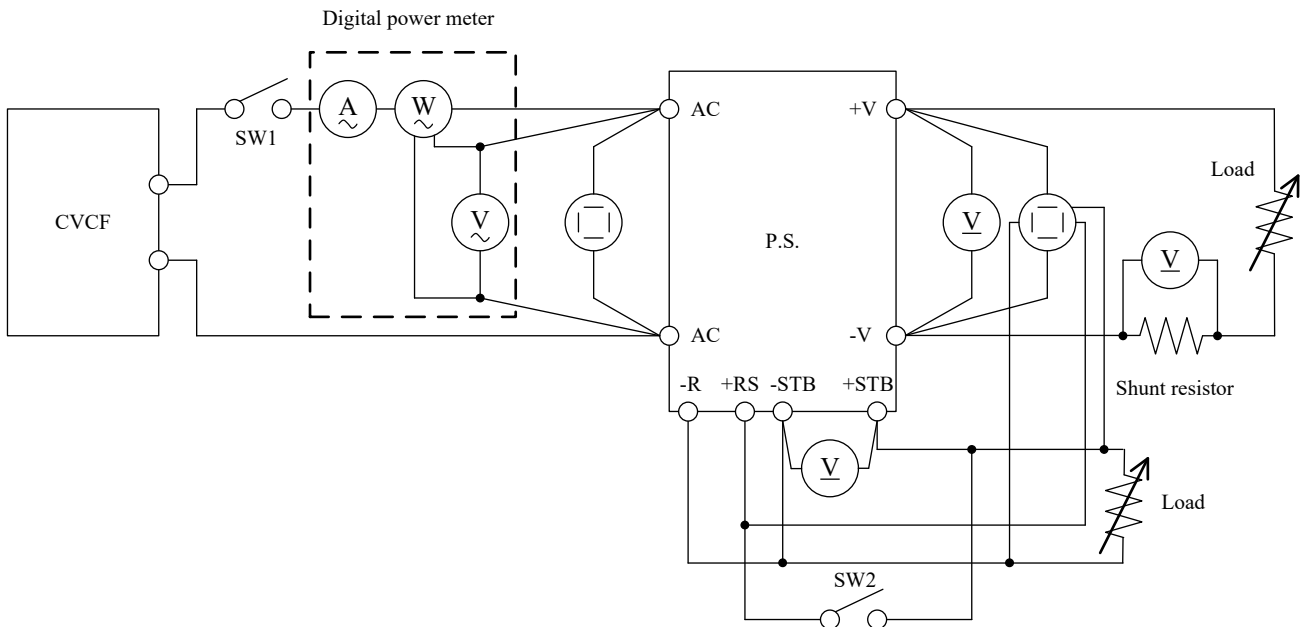

Configuration used for determination

- Electro-Magnetic Interference characteristics

(a) Conducted Emission

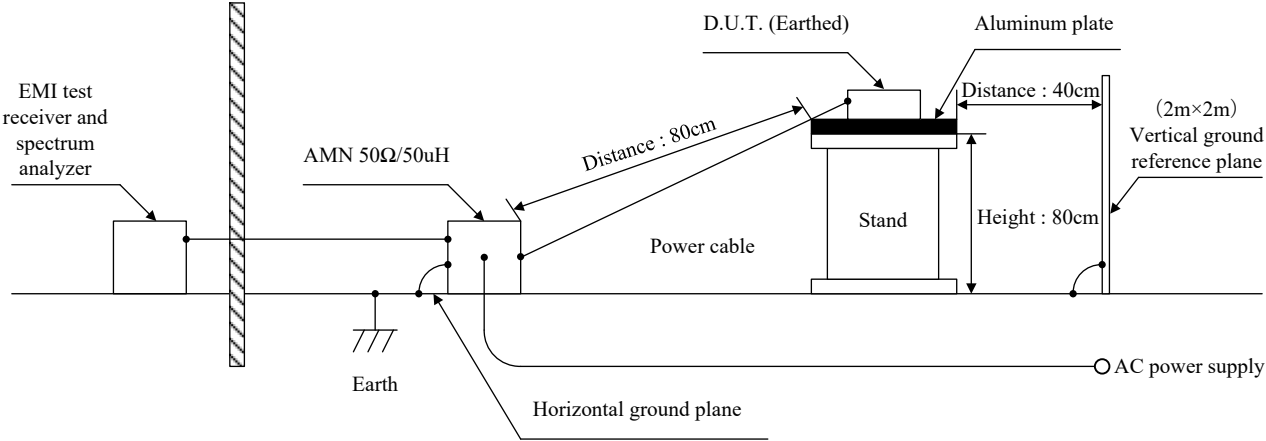

(b) Radiated Emission

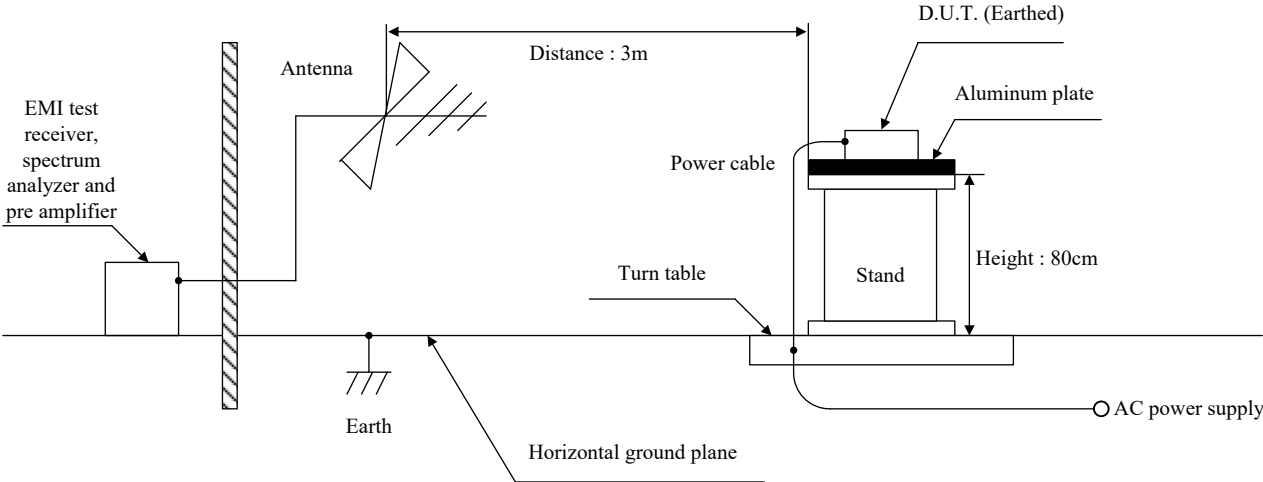

1-2. List of equipment used

	EQUIPMENT USED	MANUFACTURE	MODEL NO.
1	DIGITAL STORAGE OSCILLOSCOPE	YOKOGAWA ELECT.	DLM2054
2	DIGITAL STORAGE OSCILLOSCOPE	YOKOGAWA ELECT.	DL1740E
3	DIGITAL MULTIMETER	AGILENT	34970A
4	DIGITAL POWER METER	YOKOGAWA ELECT.	WT310E / WT210
5	DIGITAL POWER METER	HIOKI	3333 / PW3337
6	CURRENT PROBE	YOKOGAWA ELECT.	701933 / 701931
7	DYNAMIC DUMMY LOAD	CHROMA	63112A
8	DUMMY LOAD	CHROMA	63106A / 63108A
9	DUMMY LOAD	KIKUSUI	PLZ1205W
10	SLIDE REGULATOR	VOLTAC	SB-102 / 50384
11	CVCF	KIKUSUI	PCR4000LE
12	CVCF	KIKUSUI	PCR12000WE2R
13	CVCF	CHROMA	6520 / 61505
14	CVCF	AGILENT	6813B
15	SHUNT RESISTOR	YOKOGAWA ELECT.	2215
16	LEAKAGE CURRENT METER	SIMPSON	228
17	CONTROLLED TEMP. CHAMBER	ESPEC	SH-662 / SU-241
18	EMI TEST RECEIVER	ROHDE&SCHWARZ	ESCI
19	EMI TEST SPECTRUM ANALYZER	ROHDE&SCHWARZ	ESCI
20	PRE AMP	SONOMA	310
21	LISN	TOYO TECNICA	NNLK8121
22	ANTENNA	ROHDE&SCHWARZ	CBL6111D
23	DUMMY LOAD	PCN	RHF250 SERIES

1-3. Load condition

Convection cooling

V <sub>in</sub>	I <sub>out</sub>	24V	30V	36V	48V
90VAC - 265VAC	100%	14.6A	11.65A	9.7A	7.3A

Forced air cooling

V <sub>in</sub>	I <sub>out</sub>	24V	30V	36V	48V
90VAC - 265VAC	143%	20.8A	16.6A	13.8A	10.4A

\* V<sub>stb</sub>=5V, I<sub>stb</sub>=0.3A (100%)



2. Characteristics

2-1. Steady state data

(1) Line and load regulation, Temperature drift, Start up voltage and Drop out voltage

Condition Istb : 0%  
Cooling : Forced air cooling

24V

1. Line and load regulation

Condition Ta : 25°C

Iout / Vin	90VAC	100VAC	200VAC	265VAC	Line regulation	
0%	24.014V	24.002V	24.014V	24.016V	14mV	0.058%
50%	24.006V	24.006V	24.004V	24.006V	2mV	0.008%
100%	24.011V	24.010V	24.012V	24.013V	3mV	0.013%
143%	24.013V	24.012V	24.014V	24.015V	3mV	0.013%
Load regulation	8mV	10mV	10mV	10mV		
	0.033%	0.042%	0.042%	0.042%		

2. Temperature drift

Condition Vin : 100VAC  
Iout : 100%

Ta	-20°C	+25°C	+50°C	Temperature stability	
Vout	24.056V	24.010V	23.987V	69mV	0.288%

3. Start up voltage and Shut down voltage

Condition Ta : 25°C  
Iout : 100%

Start up voltage (Vin)	77VAC
Shut down voltage (Vin)	66VAC

30V

1. Line and load regulation

Condition Ta : 25°C

Iout / Vin	90VAC	100VAC	200VAC	265VAC	Line regulation	
0%	29.977V	29.993V	29.992V	29.994V	17mV	0.057%
50%	30.006V	30.006V	30.006V	30.005V	1mV	0.003%
100%	30.013V	30.013V	30.013V	30.014V	1mV	0.003%
143%	30.014V	30.014V	30.016V	30.015V	2mV	0.007%
Load regulation	37mV	21mV	24mV	21mV		
	0.123%	0.070%	0.080%	0.070%		

2. Temperature drift

Condition Vin : 100VAC  
Iout : 100%

Ta	-20°C	+25°C	-50°C	Temperature stability	
Vout	30.047V	30.013V	29.966V	81mV	0.270%

3. Start up voltage and Shut down voltage

Condition Ta : 25°C  
Iout : 100%

Start up voltage (Vin)	77VAC
Shut down voltage (Vin)	66VAC

2. Characteristics

2-1. Steady state data

(1) Line and load regulation, Temperature drift, Start up voltage and Drop out voltage

Condition Istb : 0%  
Cooling : Forced air cooling

36V

1. Line and load regulation

Condition Ta : 25°C

Iout / Vin	90VAC	100VAC	200VAC	265VAC	Line regulation	
0%	35.995V	36.002V	35.996V	36.002V	7mV	0.019%
50%	36.000V	36.000V	36.002V	36.002V	2mV	0.006%
100%	36.006V	36.005V	36.008V	36.007V	3mV	0.008%
143%	36.011V	36.010V	36.013V	36.013V	3mV	0.008%
Load regulation	16mV	10mV	17mV	11mV		
	0.044%	0.028%	0.047%	0.031%		

2. Temperature drift

Condition Vin : 100VAC  
Iout : 100%

Ta	-20°C	+25°C	-50°C	Temperature stability	
Vout	36.017V	36.005V	35.989V	28mV	0.078%

3. Start up voltage and Shut down voltage

Condition Ta : 25°C  
Iout : 100%

Start up voltage (Vin)	77VAC
Shut down voltage (Vin)	66VAC

48V

1. Line and load regulation

Condition Ta : 25°C

Iout / Vin	90VAC	100VAC	200VAC	265VAC	Line regulation	
0%	48.001V	48.006V	48.001V	48.003V	5mV	0.010%
50%	48.004V	48.005V	48.005V	48.003V	2mV	0.004%
100%	48.008V	48.010V	48.009V	48.007V	3mV	0.006%
143%	48.014V	48.015V	48.014V	48.012V	3mV	0.006%
Load regulation	13mV	10mV	13mV	9mV		
	0.027%	0.021%	0.027%	0.019%		

2. Temperature drift

Condition Vin : 100VAC  
Iout : 100%

Ta	-20°C	+25°C	-50°C	Temperature stability	
Vout	47.936V	48.010V	47.986V	74mV	0.154%

3. Start up voltage and Shut down voltage

Condition Ta : 25°C  
Iout : 100%

Start up voltage (Vin)	77VAC
Shut down voltage (Vin)	66VAC

(2) Ripple noise voltage vs. Input voltage

Condition Iout : 100%  
 Istb : 100%  
 Cooling : Convection cooling

Ta : -20°C (Blue dashed line)  
 +25°C (Green dash-dot line)  
 +50°C (Orange solid line)

24V

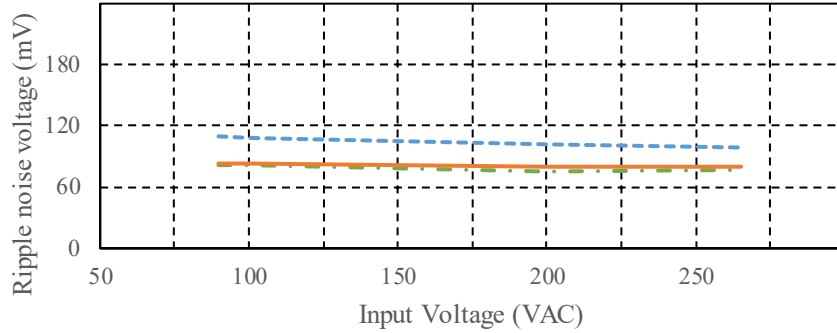

30V

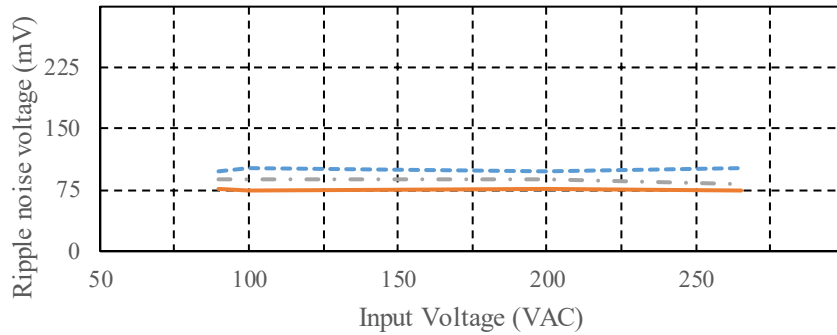

36V

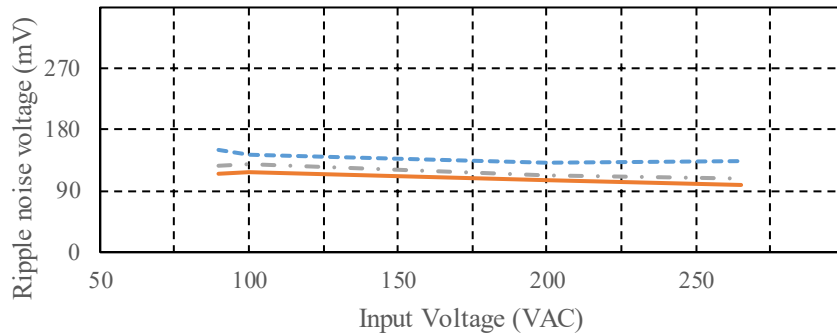

48V

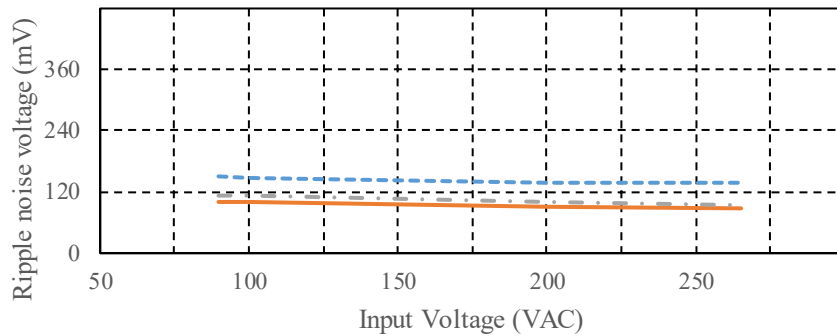

(3) Efficiency and Power factor vs. Output current

Condition Vin : 90VAC ---  
 100VAC - - -  
 200VAC ———  
 265VAC - · - ·  
 Istb : 0%  
 Cooling : Forced air cooling

Ta : 25°C

24V

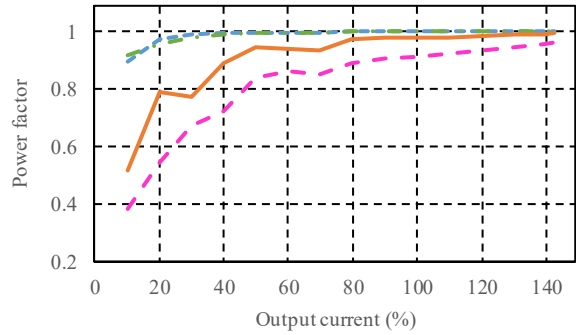
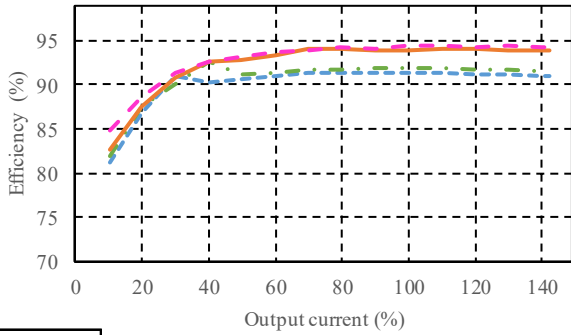

30V

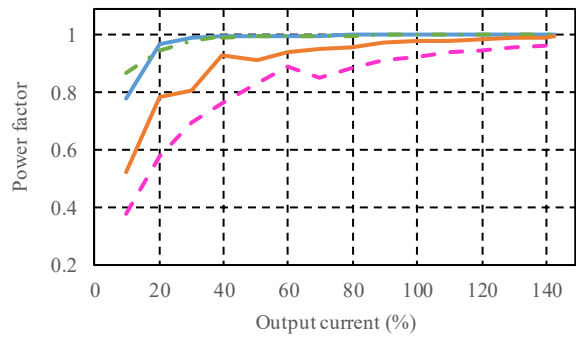
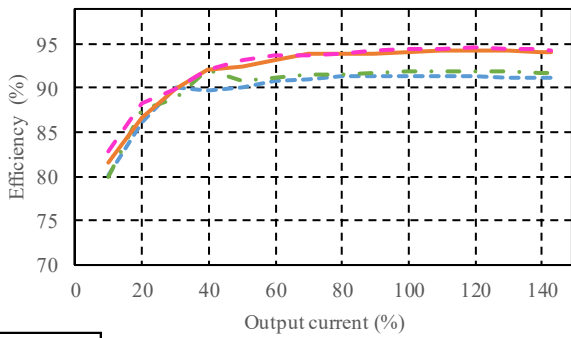

36V

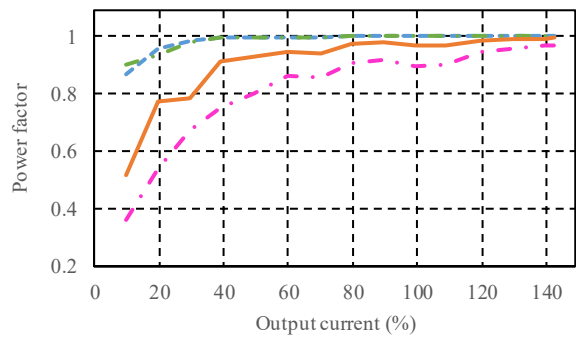
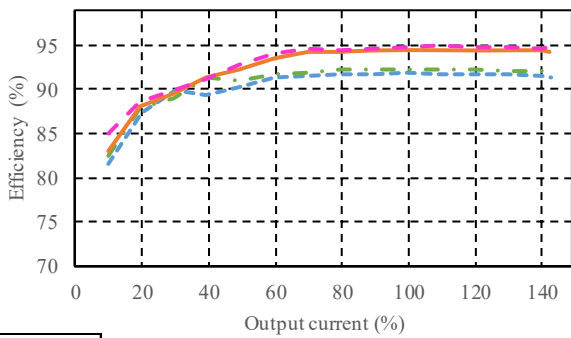

48V

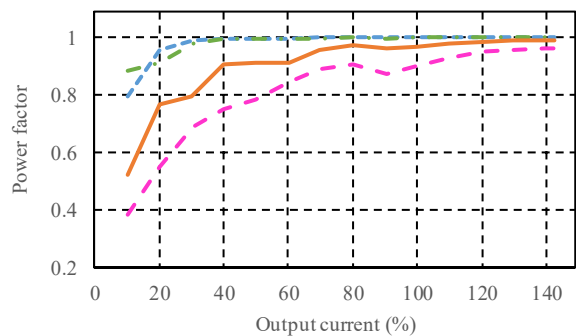
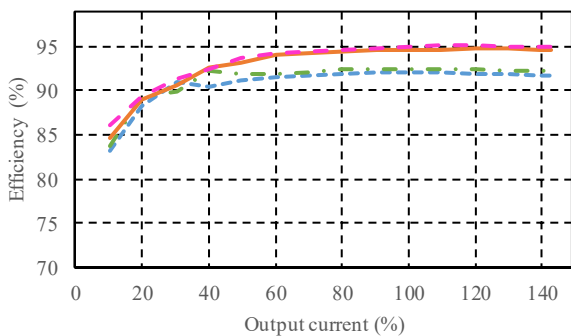

(4) Input power vs. Output current

Condition Vin : 90VAC ---  
 100VAC - - -  
 200VAC ———  
 265VAC - · - ·  
 Istb : 0%  
 Cooling : Forced air cooling  
 Ta : 25°C

24V

Input Voltage	Input Power	
	Iout : 0%	Control OFF
90VAC	1.8W	0.6W
100VAC	1.6W	0.6W
200VAC	1.4W	0.8W
265VAC	1.4W	1.1W

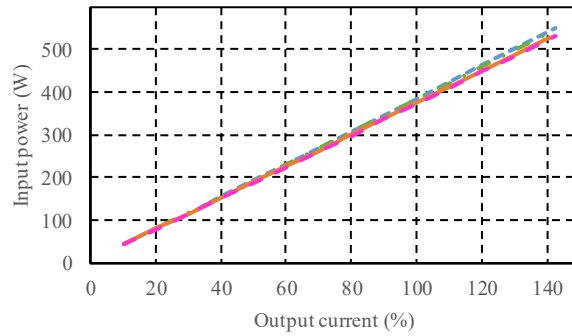

30V

Input Voltage	Input Power	
	Iout : 0%	Control OFF
90VAC	3.3W	0.6W
100VAC	3.4W	0.6W
200VAC	2.6W	0.8W
265VAC	2.4W	1.0W

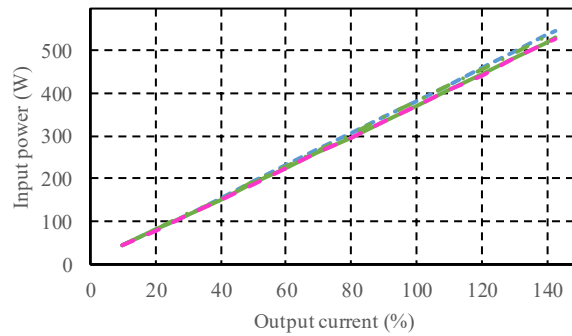

36V

Input Voltage	Input Power	
	Iout : 0%	Control OFF
90VAC	2.1W	0.6W
100VAC	2.0W	0.6W
200VAC	1.6W	0.8W
265VAC	1.6W	1.0W

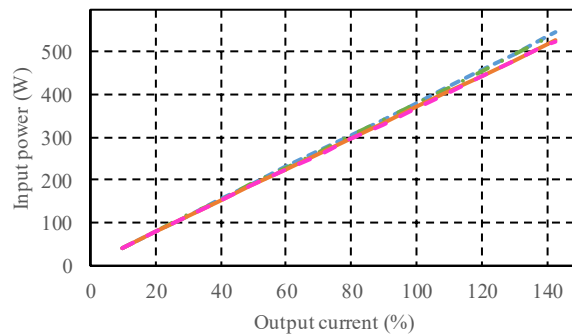

48V

Input Voltage	Input Power	
	Iout : 0%	Control OFF
90VAC	2.3W	0.6W
100VAC	2.1W	0.6W
200VAC	1.6W	0.8W
265VAC	1.6W	1.1W

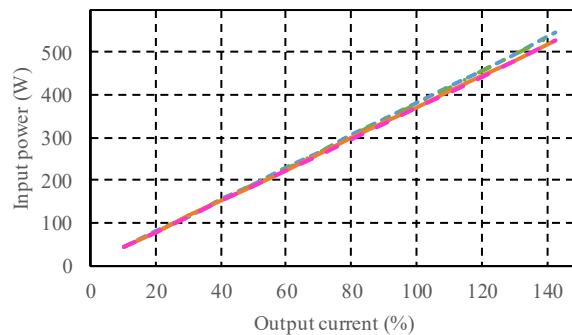

(5) Input current vs. Output current

Condition Vin : 90VAC ---  
 100VAC - - -  
 200VAC ———  
 265VAC - · - ·  
 Istb : 0%  
 Cooling : Forced air cooling

Ta : 25°C

24V

Input Voltage	Input Current	
	Iout : 0%	Control OFF
90VAC	0.09A	0.01A
100VAC	0.10A	0.08A
200VAC	0.17A	0.17A
265VAC	0.23A	0.22A

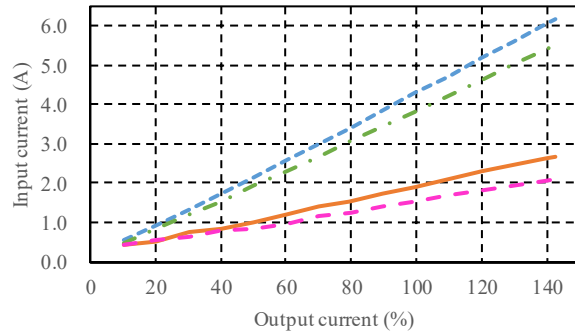

30V

Input Voltage	Input Current	
	Iout : 0%	Control OFF
90VAC	0.11A	0.13A
100VAC	0.11A	0.17A
200VAC	0.18A	0.24A
265VAC	0.23A	0.29A

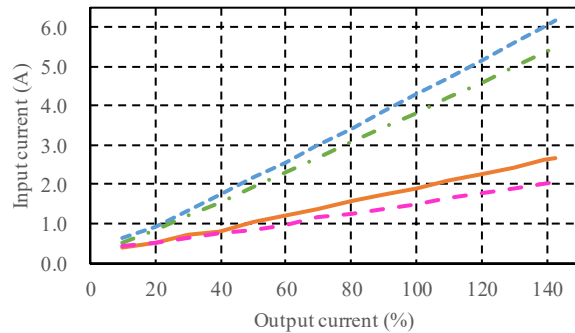

36V

Input Voltage	Input Current	
	Iout : 0%	Control OFF
90VAC	0.10A	0.13A
100VAC	0.10A	0.14A
200VAC	0.17A	0.24A
265VAC	0.23A	0.29A

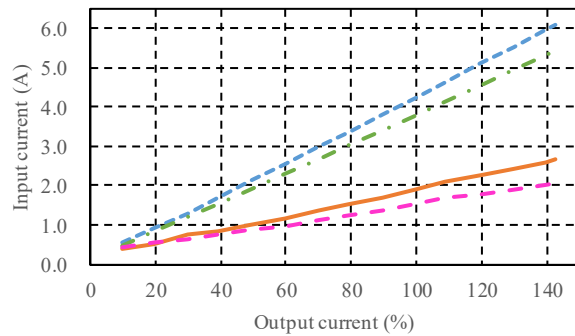

48V

Input Voltage	Input Current	
	Iout : 0%	Control OFF
90VAC	0.10A	0.07A
100VAC	0.10A	0.08A
200VAC	0.17A	0.17A
265VAC	0.23A	0.22A

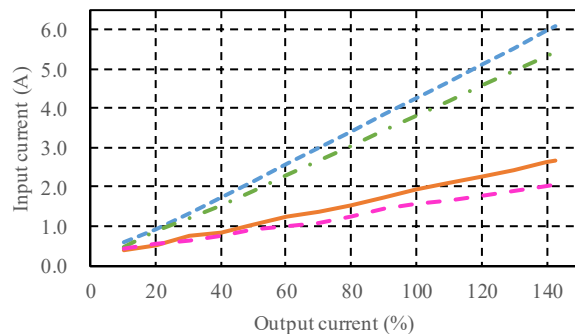

2-2. Warm up voltage drift characteristics

Condition Vin : 100VAC  
 Iout : 100%  
 Istb : 100%  
 Cooling : Convection cooling

24V

Ta : 25°C

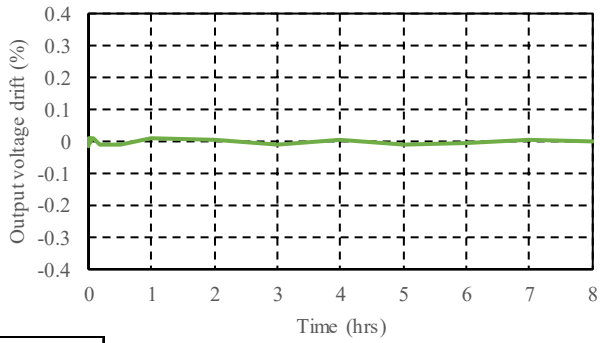

30V

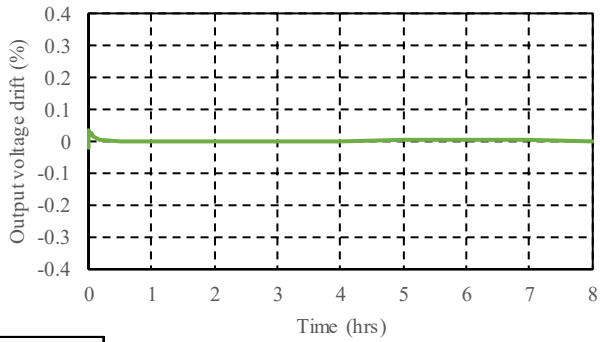

36V

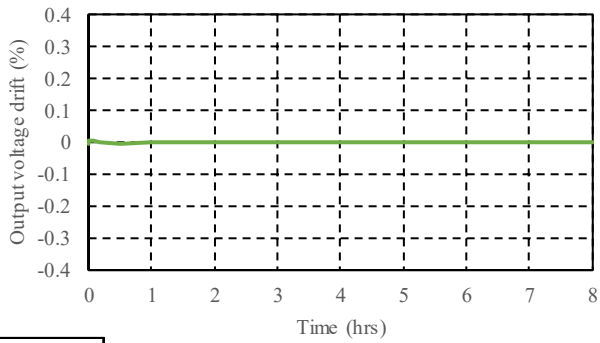

48V

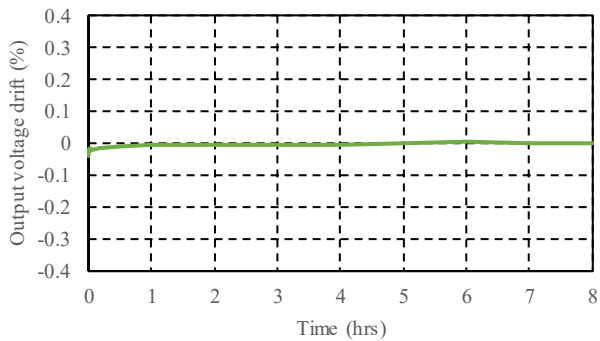

2-3. Hold up time characteristics

Condition Vin : 100VAC  
 200VAC  
 Istb : 100%  
 Cooling : Forced air cooling

Ta : 25°C

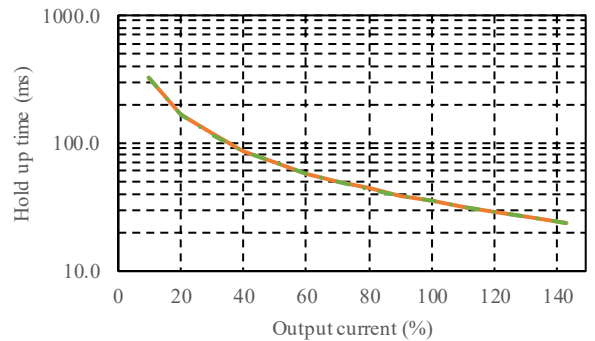
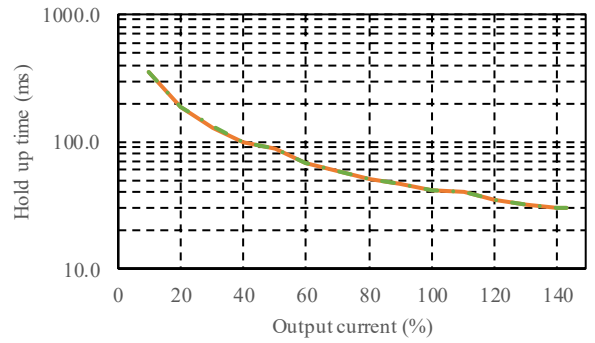
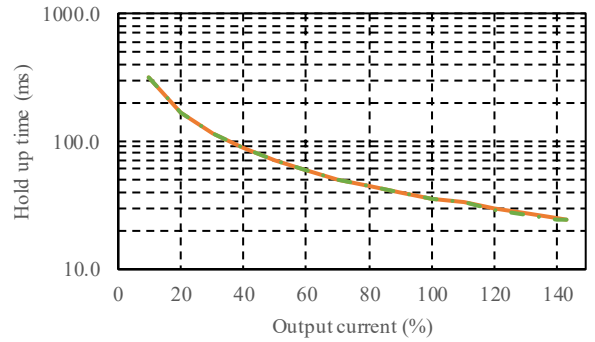
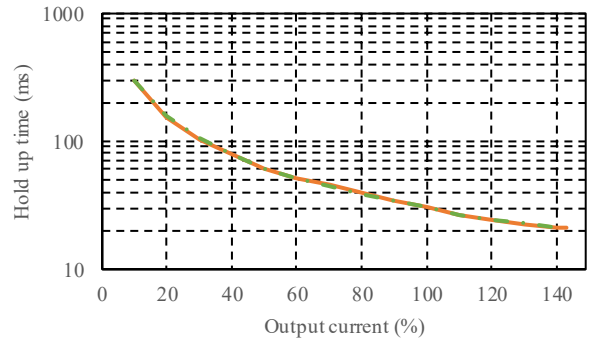

2-4. Output rise characteristics

Condition Vin : 90VAC (A)  
100VAC (B)  
200VAC (C)  
265VAC (D)  
Istb : 100%  
Cooling : Convection cooling

Ta : 25°C

24V

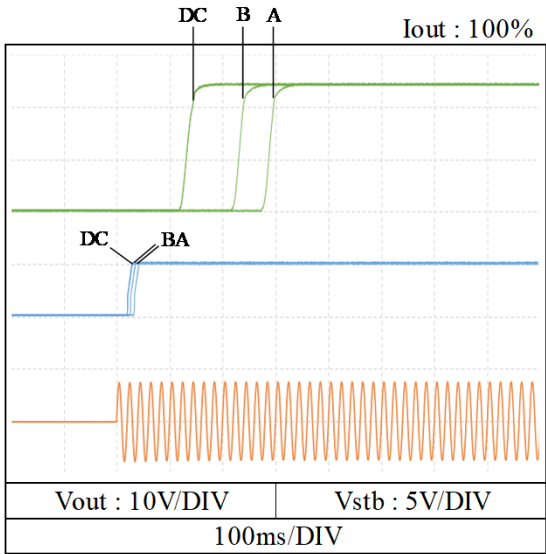
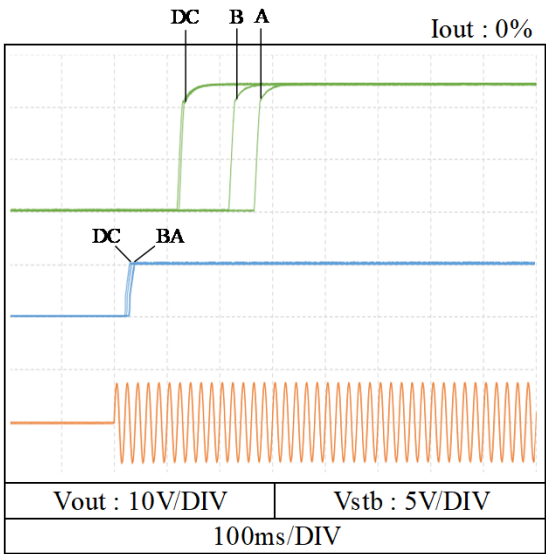

30V

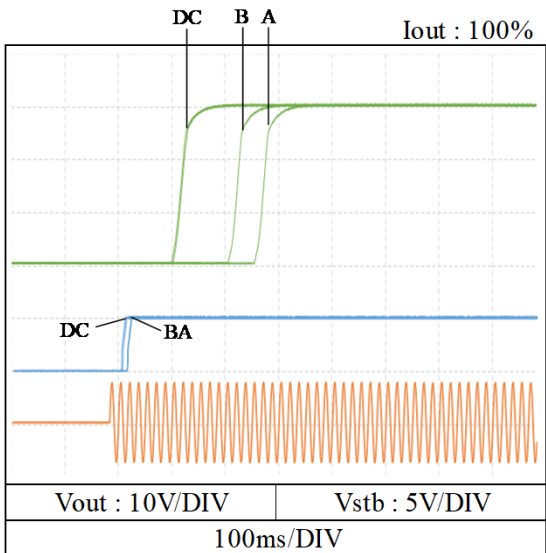
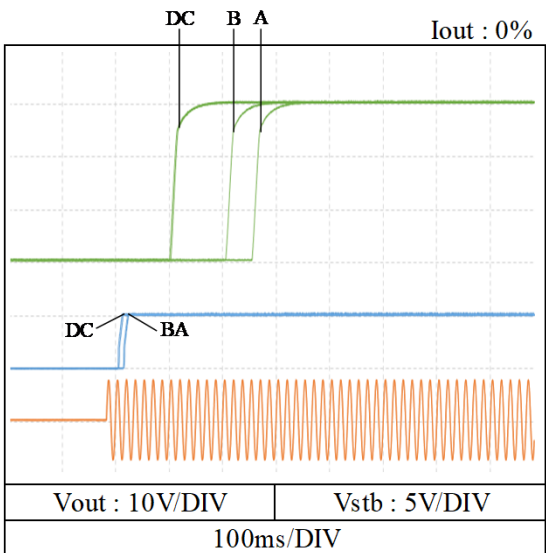



2-4. Output rise characteristics

Condition Vin : 90VAC (A)  
100VAC (B)  
200VAC (C)  
265VAC (D)  
Istb : 100%  
Cooling : Convection cooling

Ta : 25°C

36V

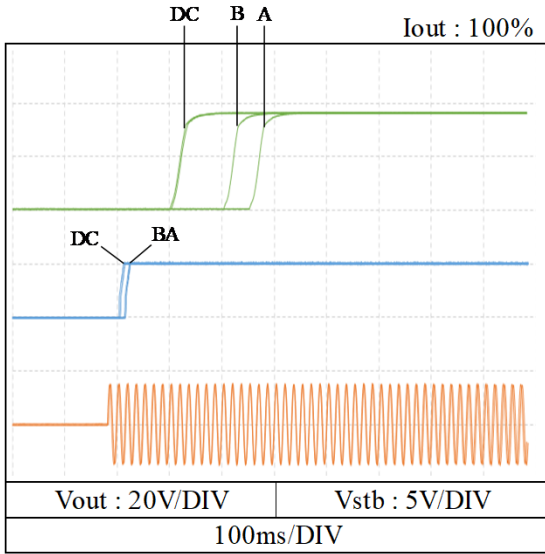
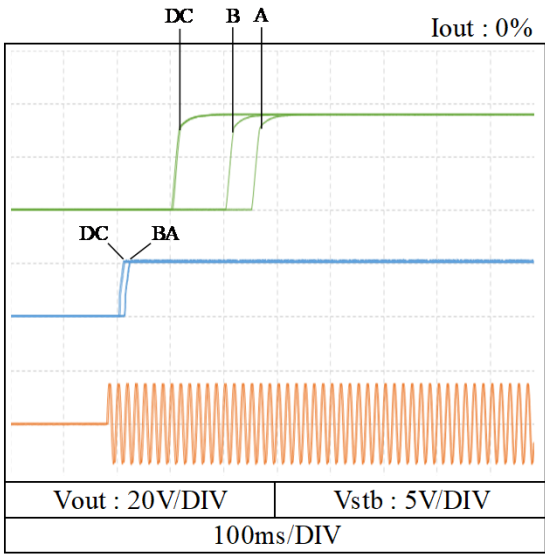

48V

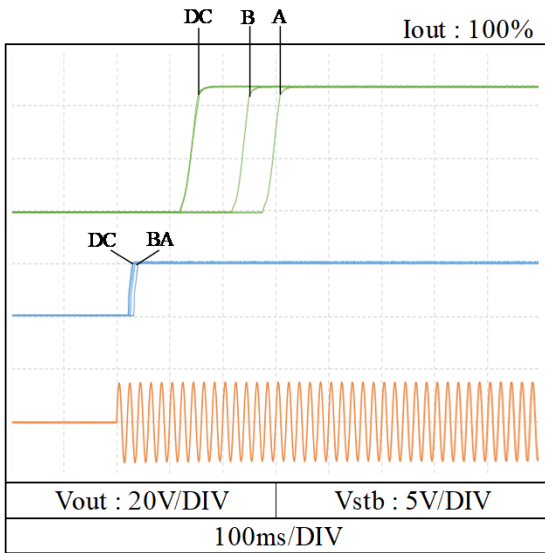
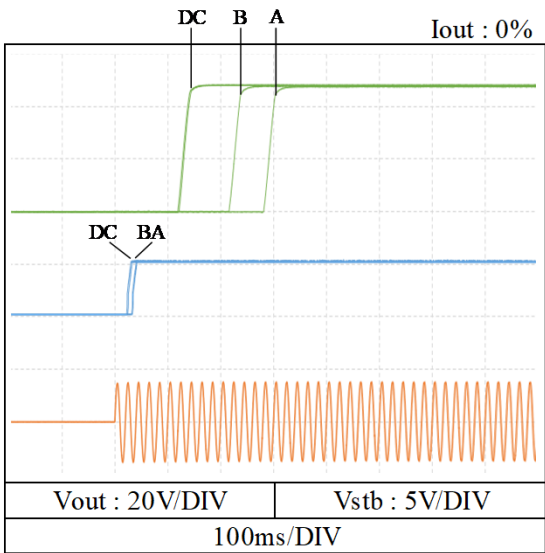

2-5. Output fall characteristics

Condition Vin : 90VAC (A)  
 100VAC (B)  
 200VAC (C)  
 265VAC (D)  
 Istb : 100%  
 Cooling : Convection cooling

Ta : 25°C

24V

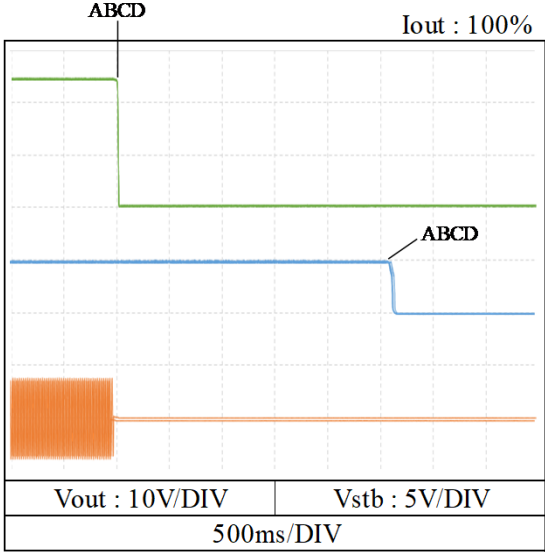
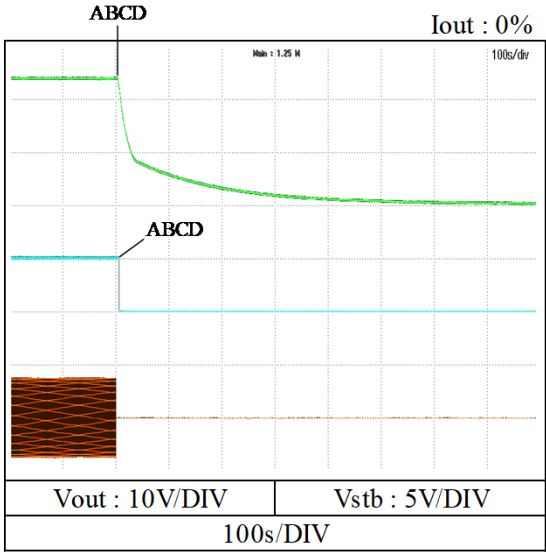

30V

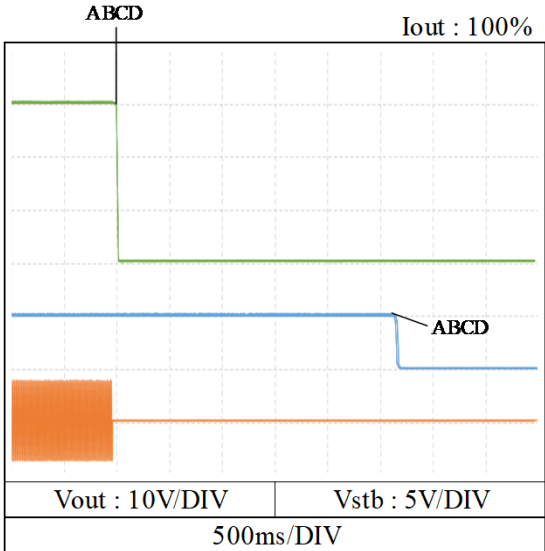
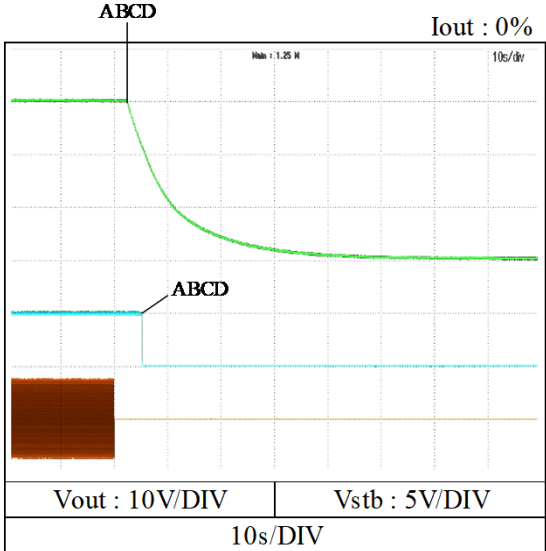

2-5. Output fall characteristics

Condition Vin : 90VAC (A)  
 100VAC (B)  
 200VAC (C)  
 265VAC (D)  
 Istb : 100%  
 Cooling : Convection cooling

Ta : 25°C

36V

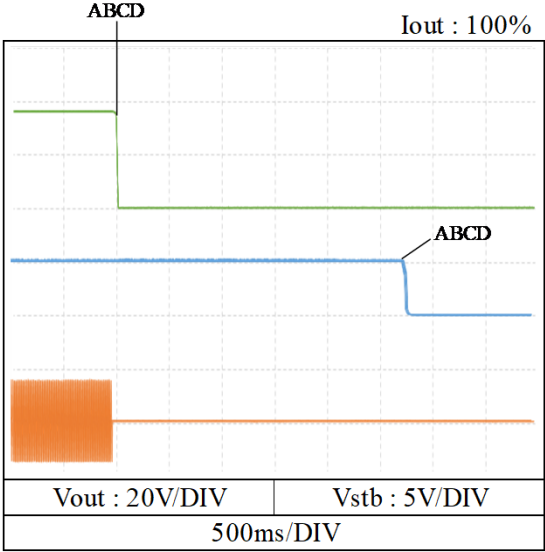
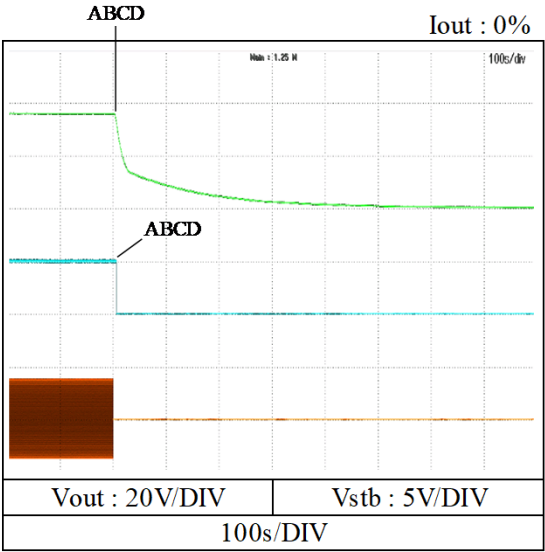

48V

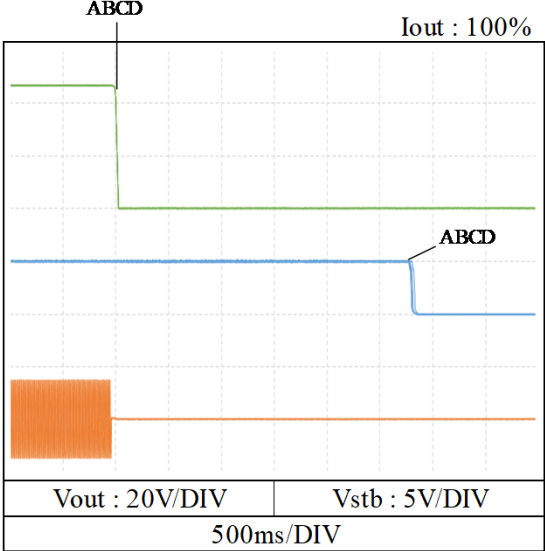
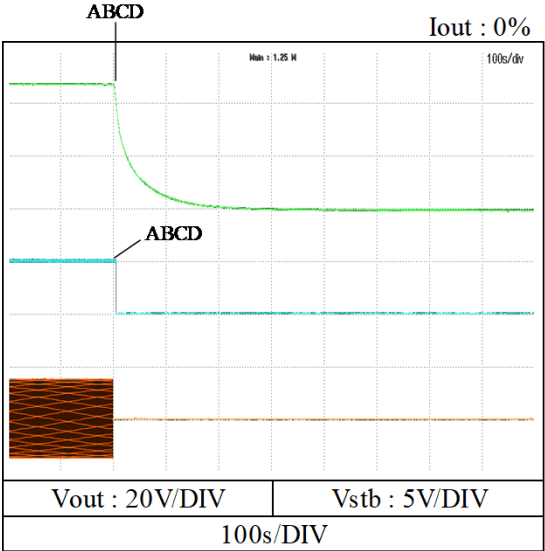

2-6. Output rise and fall characteristics with ON/OFF Control

Condition       $V_{in}$  : 100VAC  
 $I_{out}$  : 100%  
 $I_{stb}$  : 100%  
 Cooling : Forced air cooling  
  
 $T_a$  : 25°C

24V

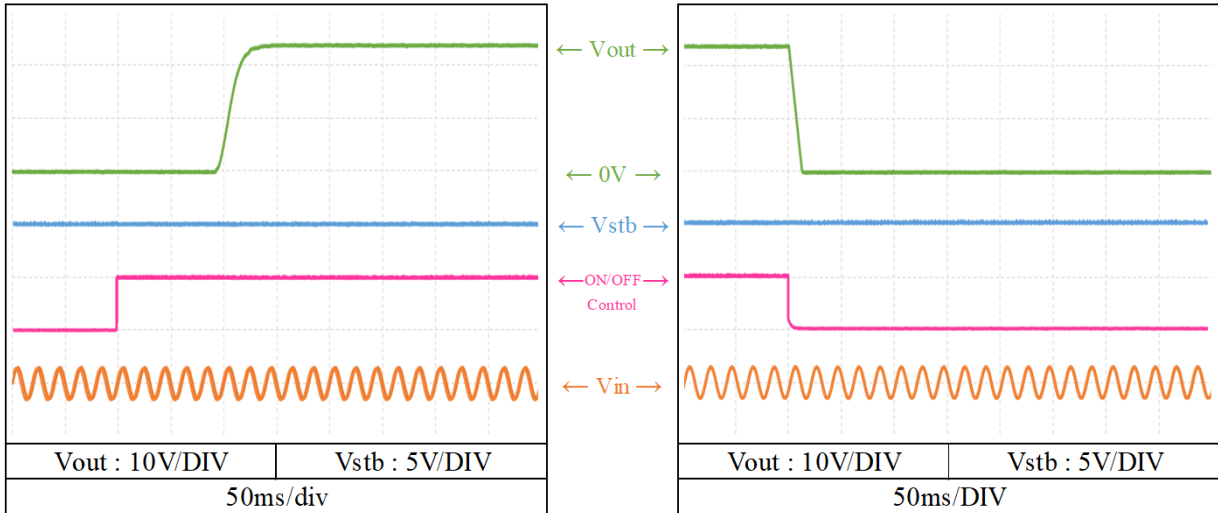

30V

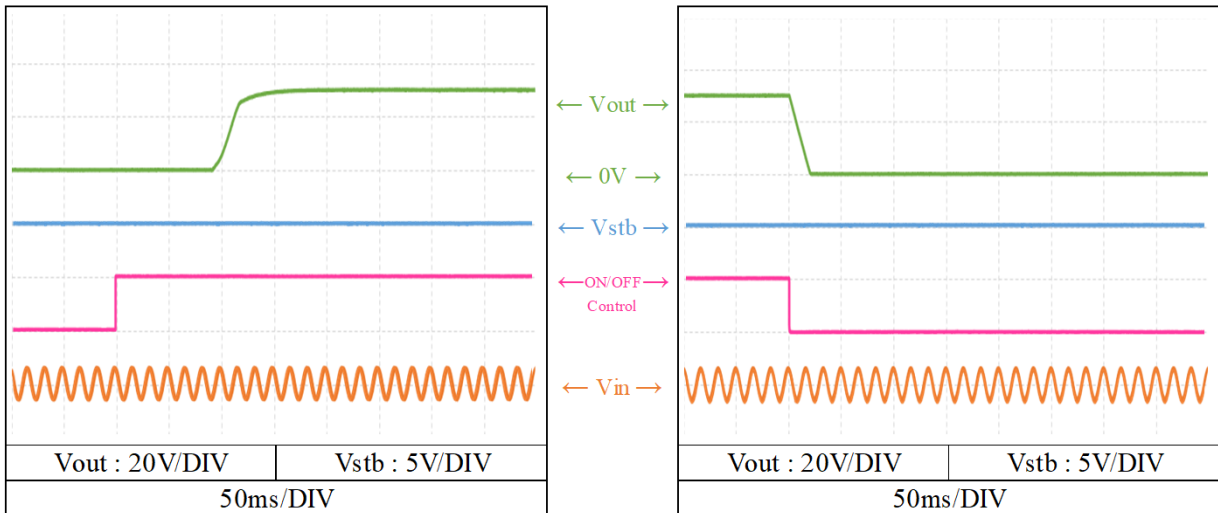

2-6. Output rise and fall characteristics with ON/OFF Control

Condition Vin : 100VAC  
 Iout : 100%  
 Istb : 100%  
 Cooling : Forced air cooling

Ta : 25°C

36V

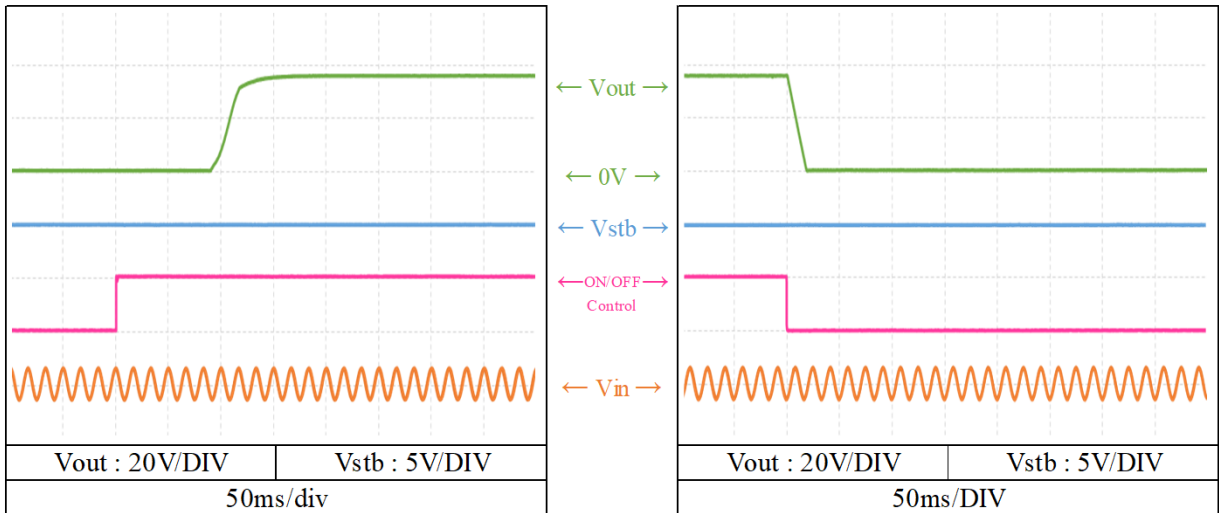

48V

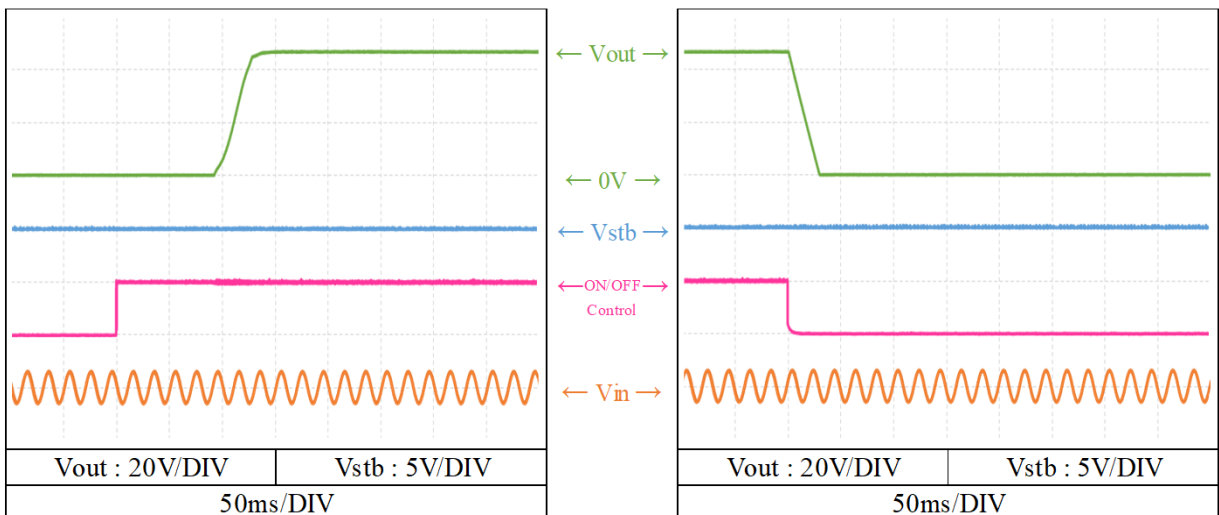

2-7. Over current protection (OCP) characteristics

Condition Vin : 100VAC  
 Istb : 100%  
 Cooling : Convection cooling

Ta : -20°C ——— (blue dashed)  
 25°C ——— (green dashed)  
 50°C ——— (orange solid)

24V

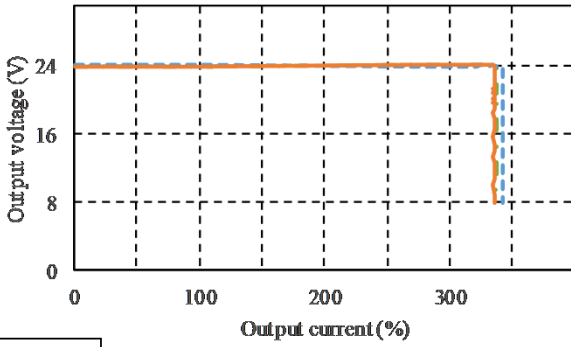

30V

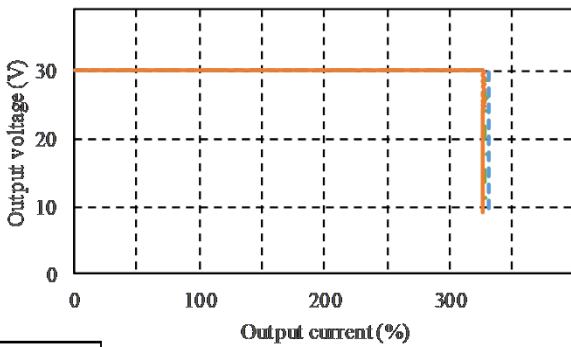

36V

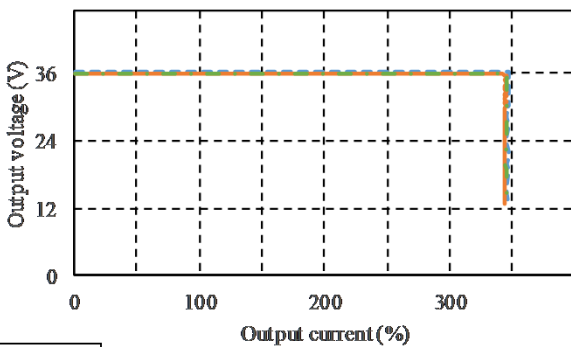

48V

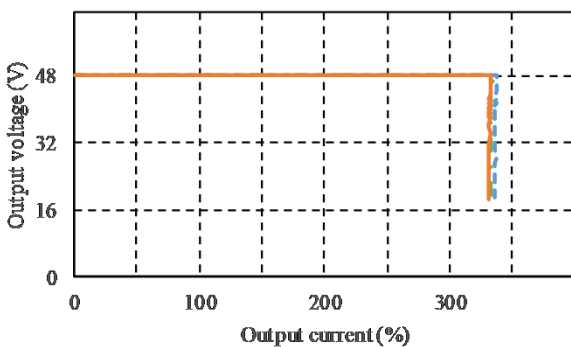

2-8. Over voltage protection (OVP) characteristics

Condition Vin : 100VAC  
 Iout : 0%  
 Cooling : Convection cooling  
 Istb : 0%

Ta : 25°C

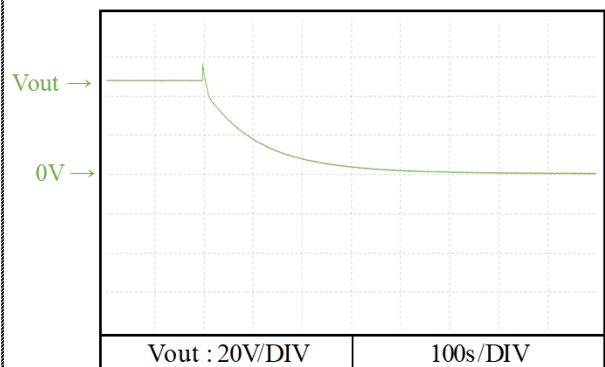
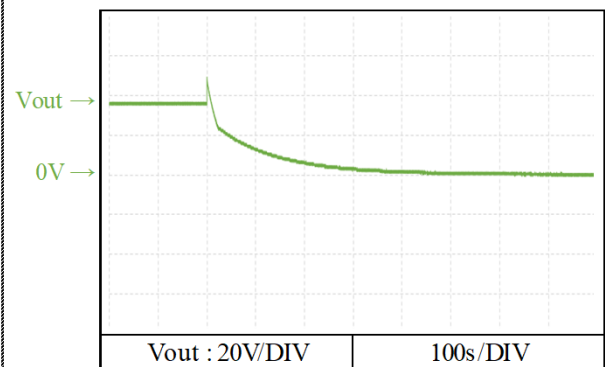
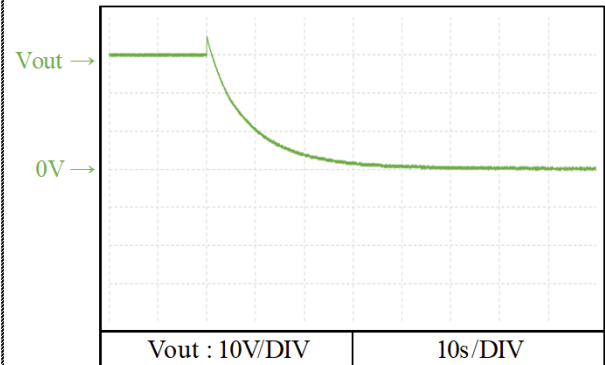
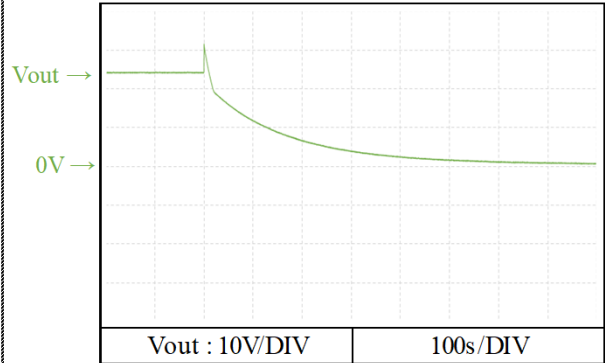

2-9. Dynamic load response characteristics

Condition  $V_{in}$  : 100VAC  
 $I_{out}$  : 50%  $\leftrightarrow$  100%  
 ( $t_r = t_f = 75\mu s$ )  
 $I_{stb}$  : 100%  
 Cooling : Convection cooling  
 $T_a$  : 25°C

24V

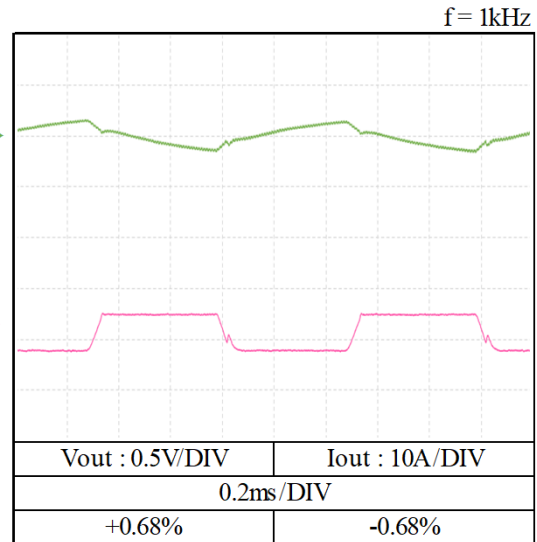
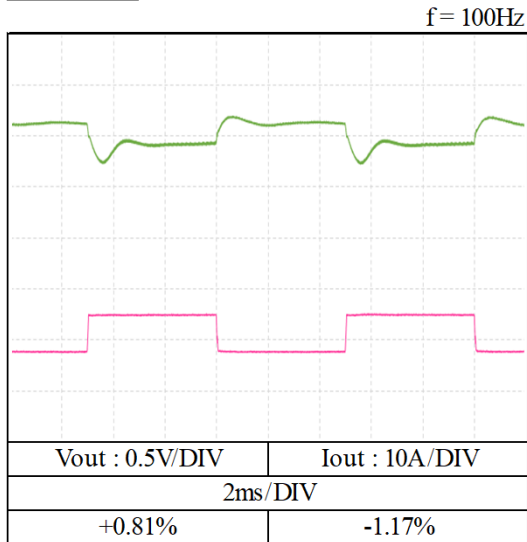

30V

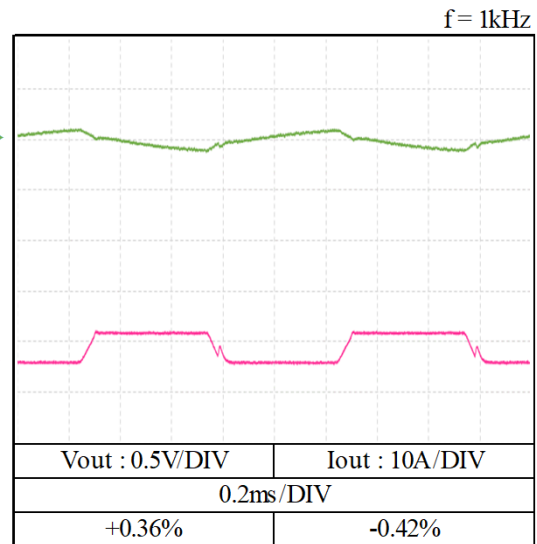
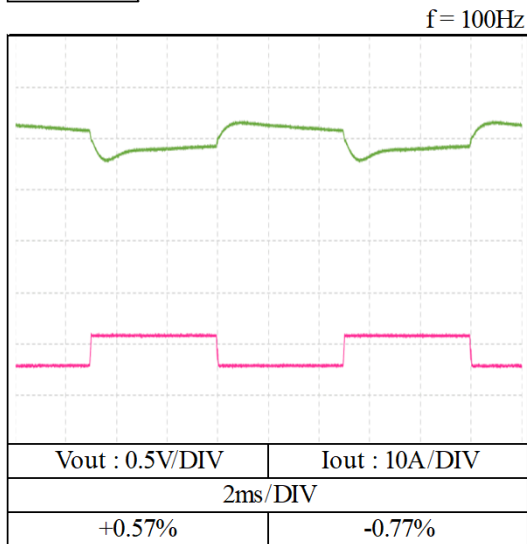

2-9. Dynamic load response characteristics

Condition Vin : 100VAC  
Iout : 50% ↔ 100%  
(tr = tf = 75us)  
Istb : 100%  
Cooling : Convection cooling  
Ta : 25°C

36V

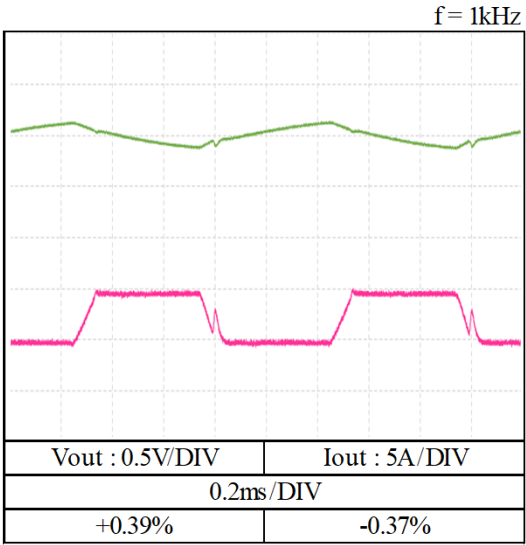
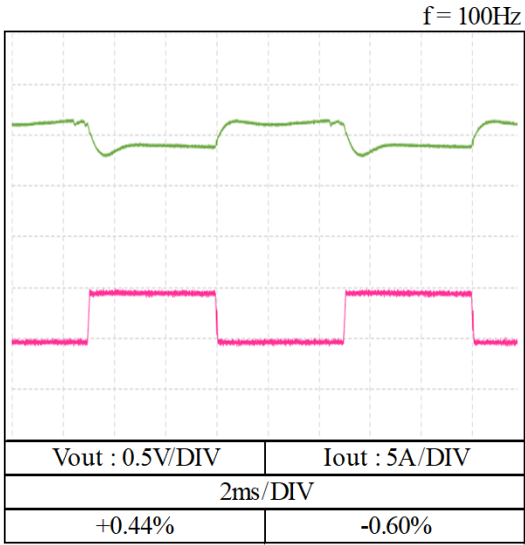

48V

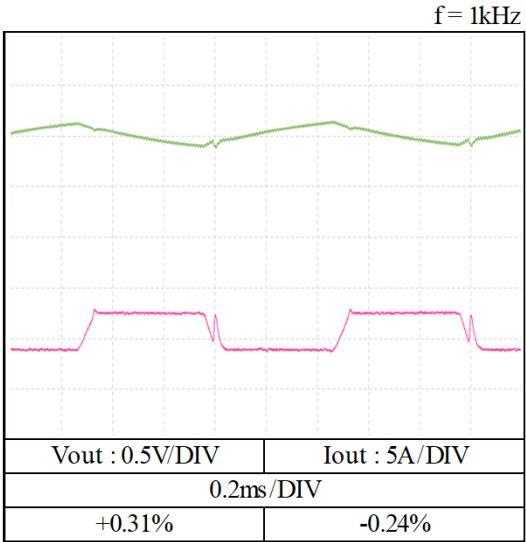
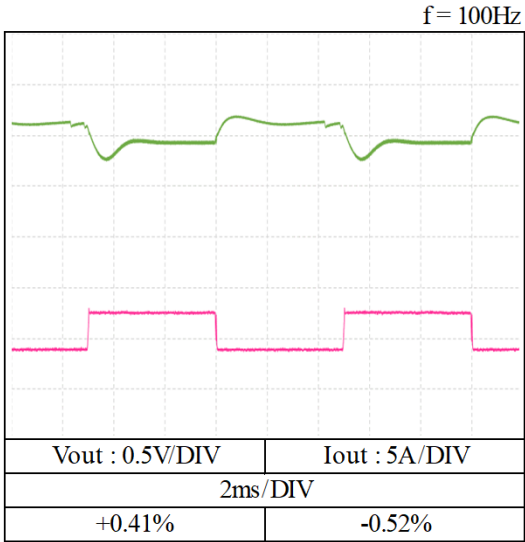



2-9. Dynamic load response characteristics

Condition Vin : 100VAC  
 Iout/Pout : 25% ↔ 800W  
 (tr = tf = 75us)  
 Istb : 100%  
 Cooling : Convection cooling

Ta : 25°C

24V

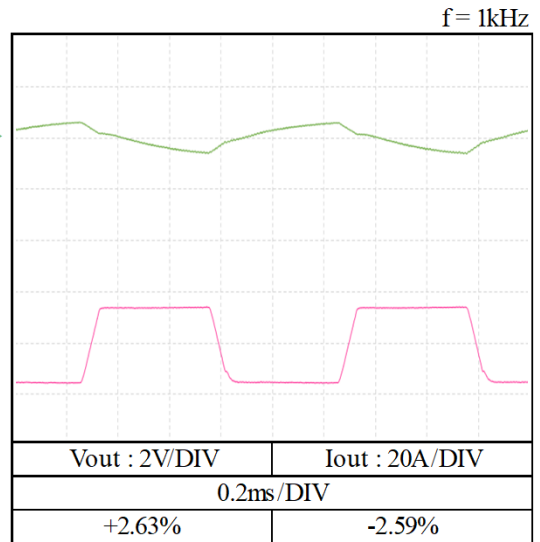
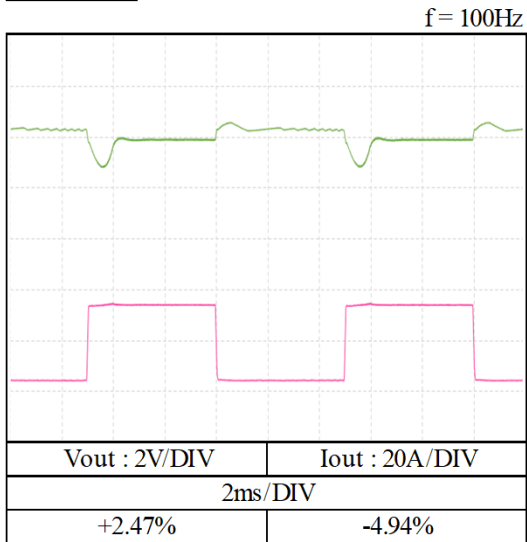

30V

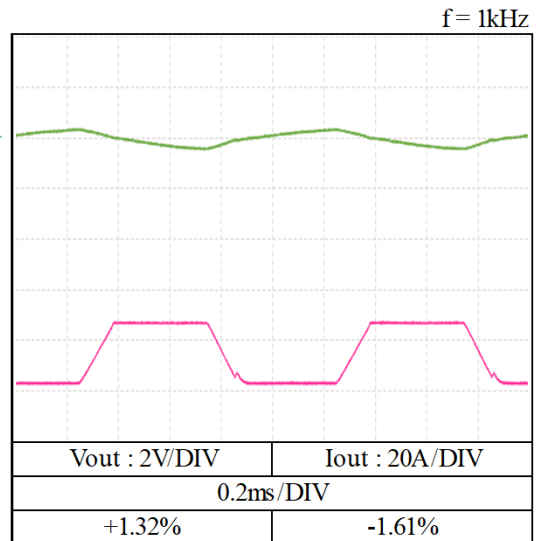
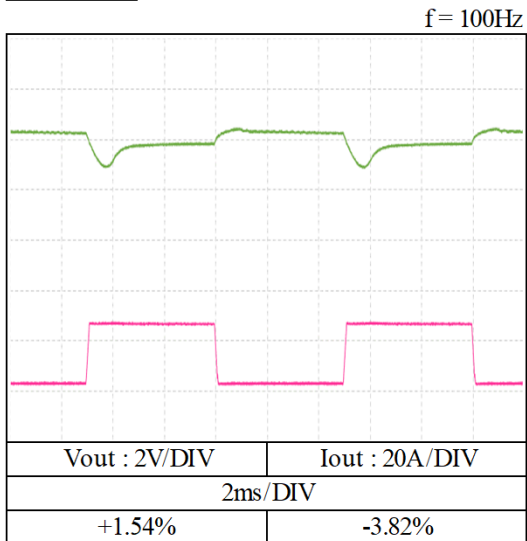

2-9. Dynamic load response characteristics

Condition Vin : 100VAC  
 Iout/Pout : 25% ↔ 800W  
 (tr = tf = 75us)  
 Istb : 100%  
 Cooling : Convection cooling  
 Ta : 25°C

36V

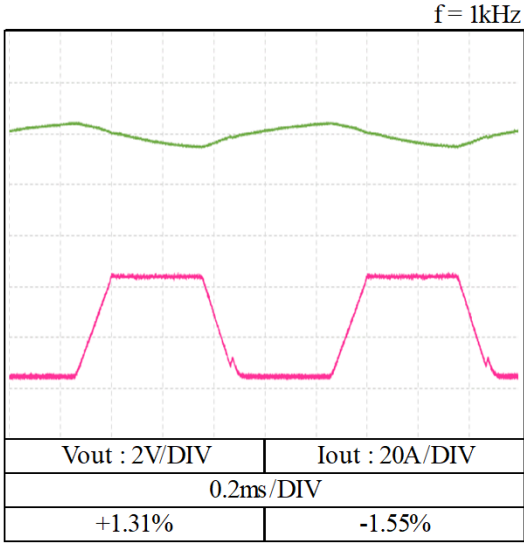
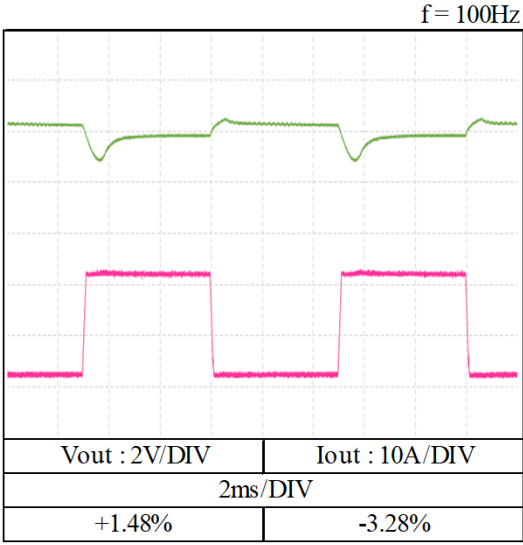

48V

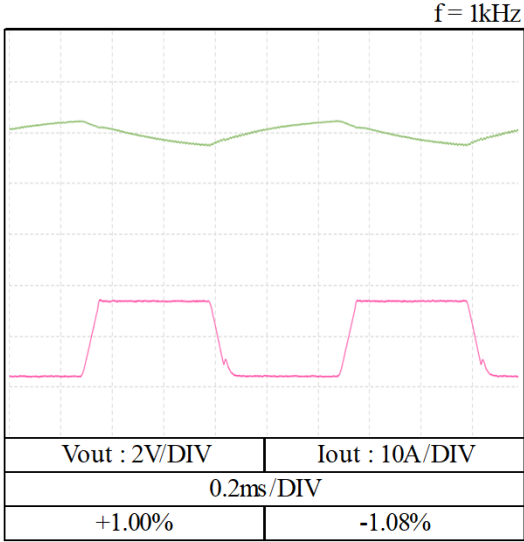
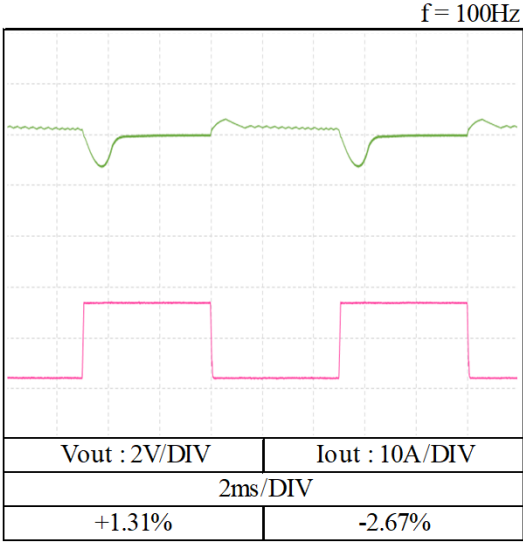

2-9. Dynamic load response characteristics

Condition Vin : 200VAC  
 Iout/Pout : 25% ↔ 1000W  
 (tr = tf = 75us)  
 Istb : 100%  
 Cooling : Convection cooling  
 Ta : 25°C

24V

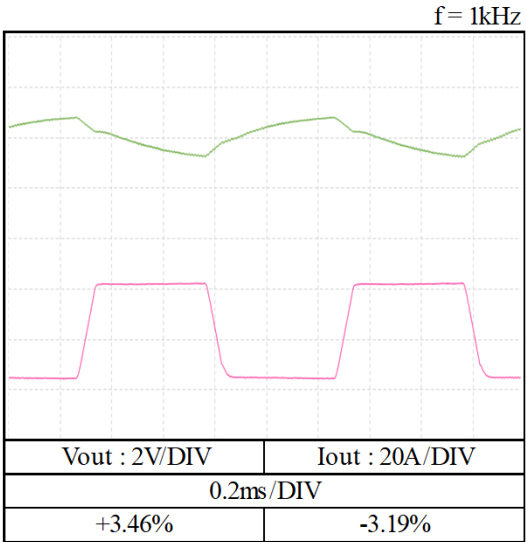
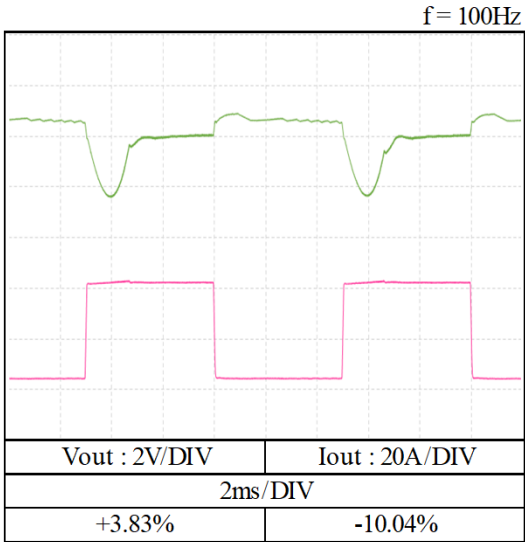

30V

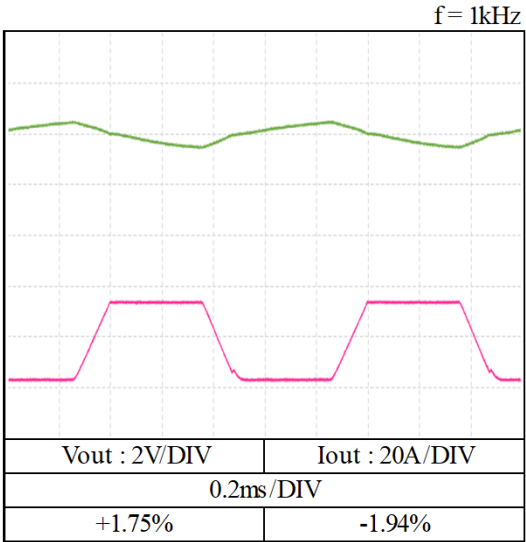
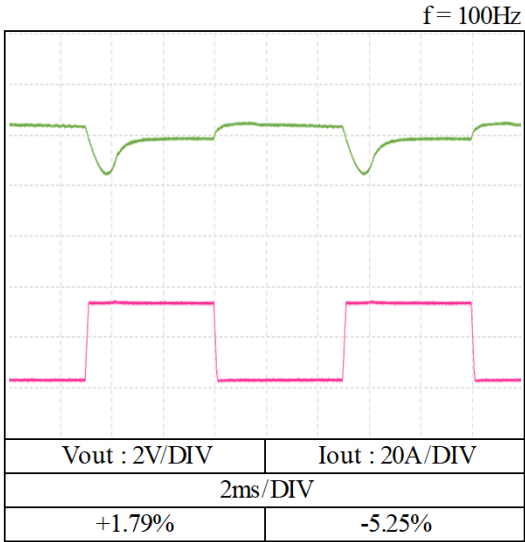

2-9. Dynamic load response characteristics

Condition Vin : 200VAC  
 Iout/Pout : 25% ↔ 1000W  
 (tr = tf = 75us)  
 Istb : 100%  
 Cooling : Convection cooling  
 Ta : 25°C

36V

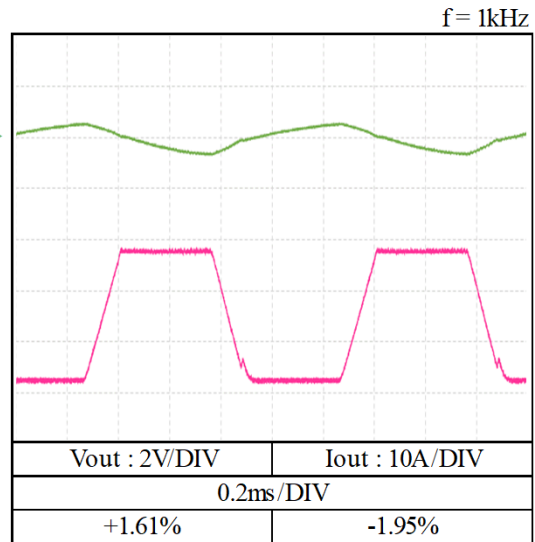
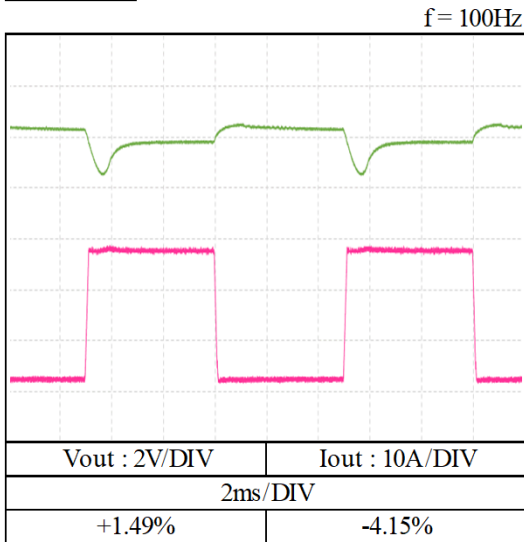

48V

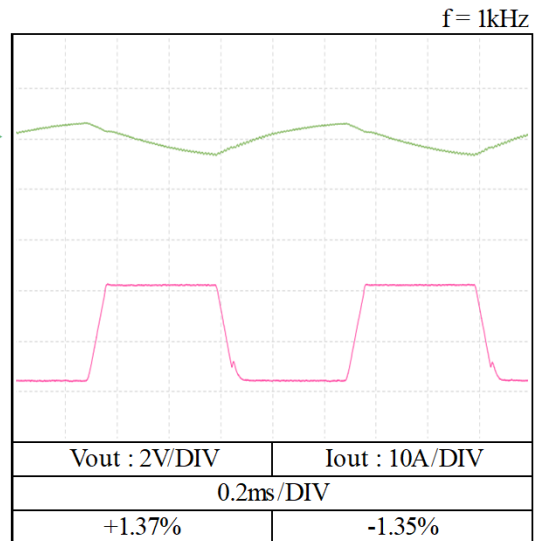
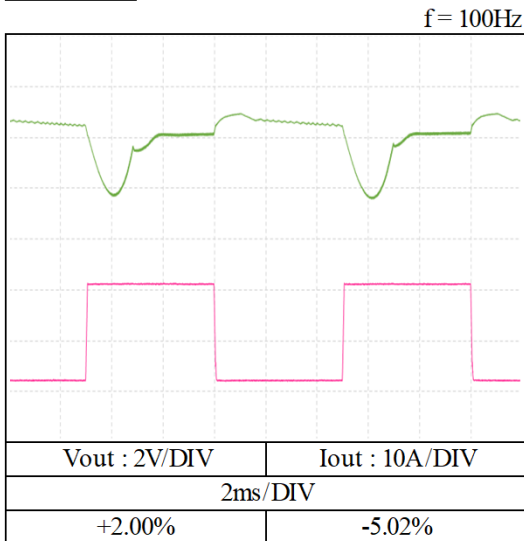

2-10. Response to brown out characteristics

Condition      Iout : 100%  
                  Istb : 100%  
Cooling : Convection cooling

Interruption time

Ta : 25°C

- A : No output voltage drop
- B : No output voltage drop to 0V
- C : Output voltage drops to 0V

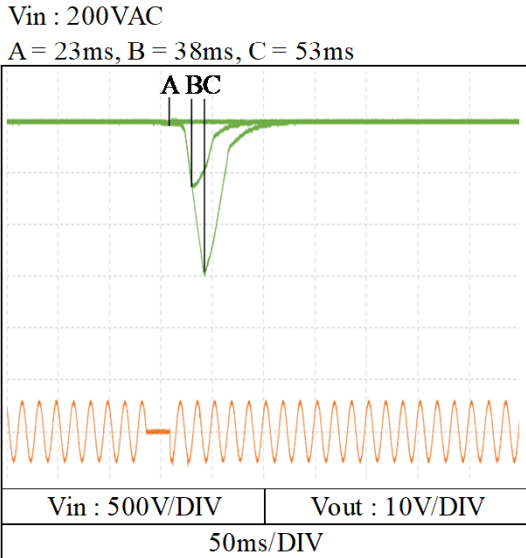
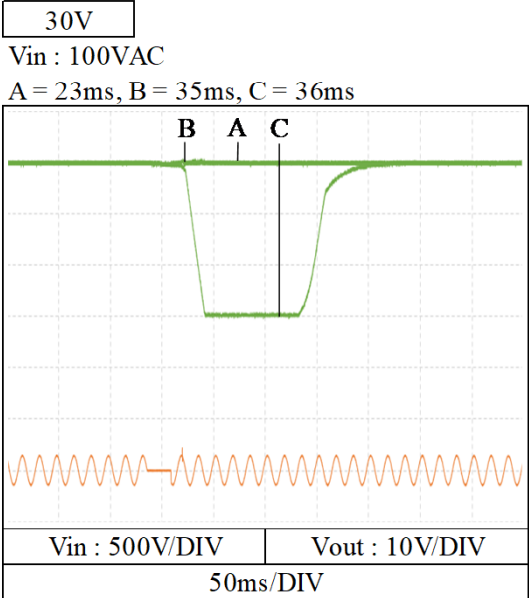
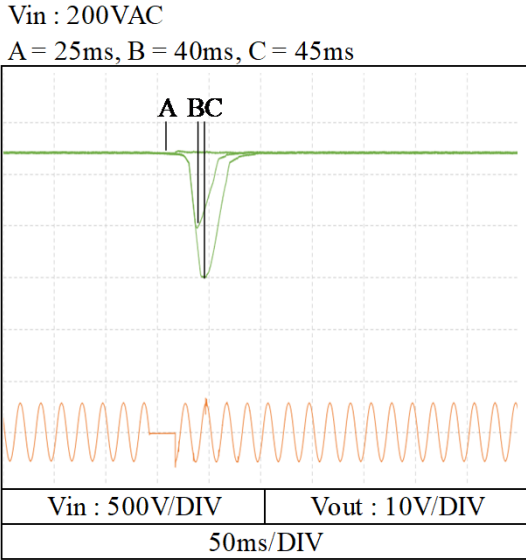
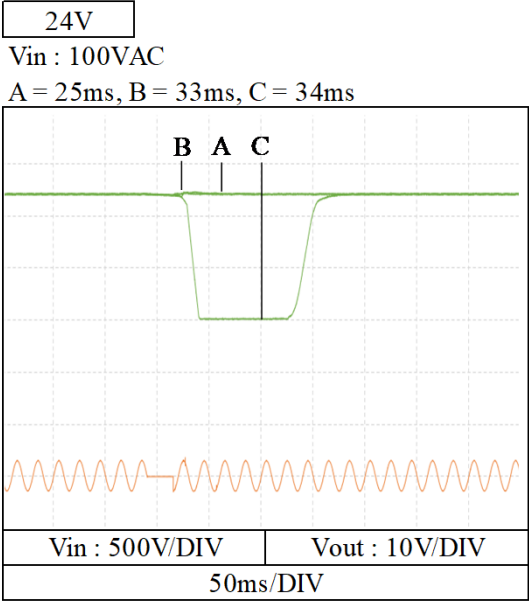

2-10. Response to brown out characteristics

Condition      Iout : 100%  
                  Istb : 100%  
Cooling : Convection cooling  
  
                  Ta : 25°C

Interruption time  
A : No output voltage drop  
B : No output voltage drop to 0V  
C : Output voltage drops to 0V

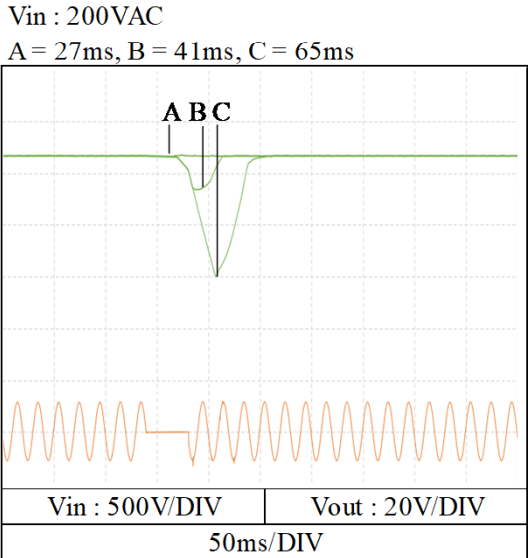
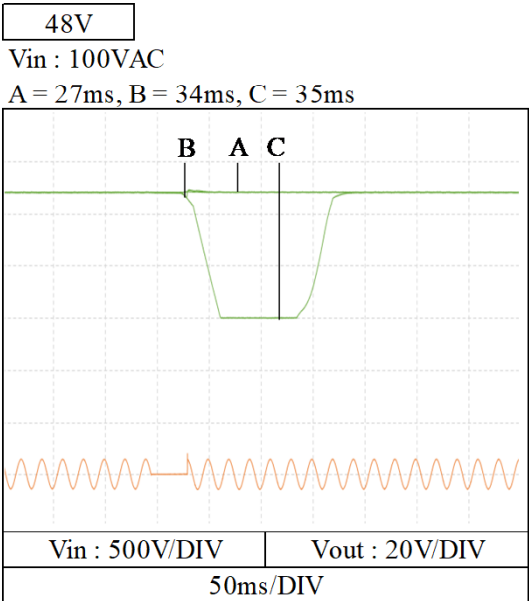
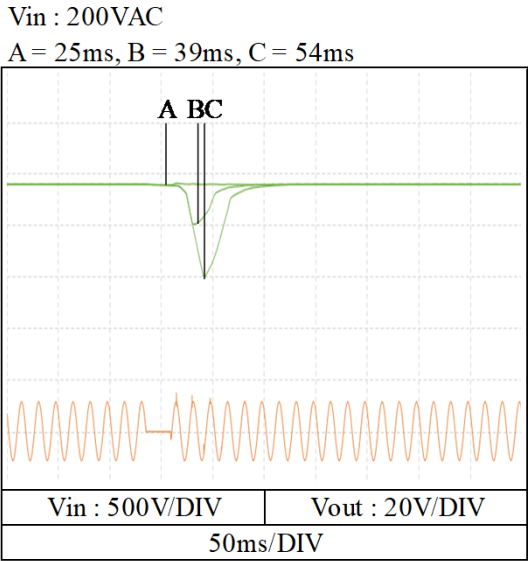
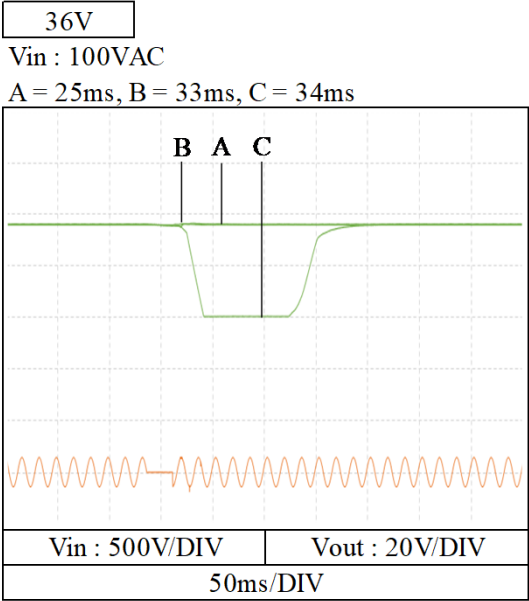

2-11. Inrush current waveform

Condition Vin : 100VAC  
 Iout : 100%  
 Istb : 100%  
 Cooling : Convection cooling

Ta : 25°C

24V

Input tum on at  $\phi = 0^\circ$

Input tum on at  $\phi = 90^\circ$

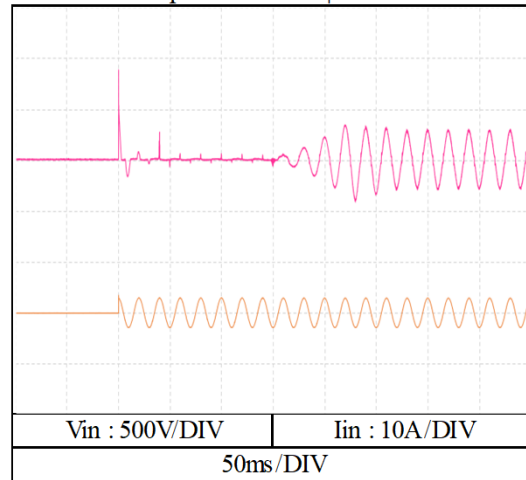
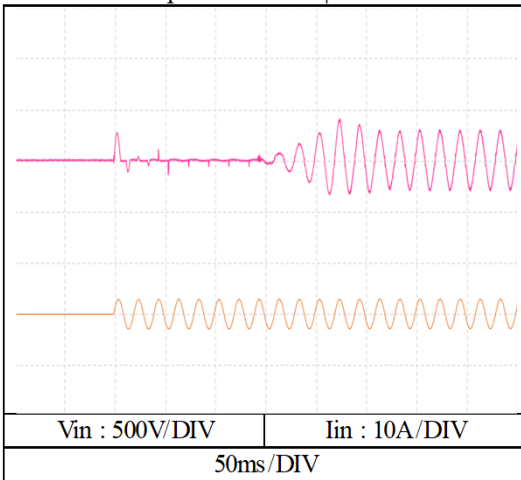

Condition Vin : 200VAC  
 Iout : 100%  
 Istb : 100%  
 Cooling : Convection cooling

Ta : 25°C

Input tum on at  $\phi = 0^\circ$

Input tum on at  $\phi = 90^\circ$

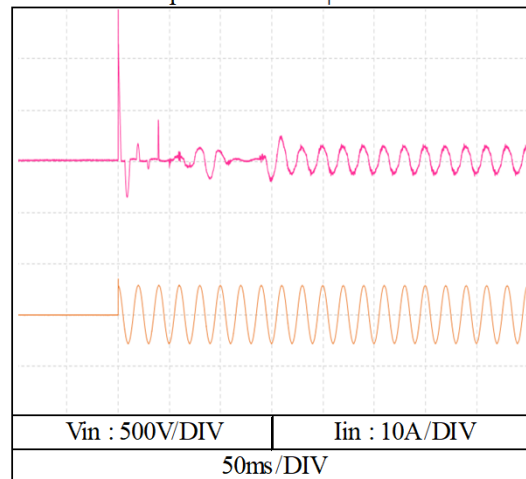
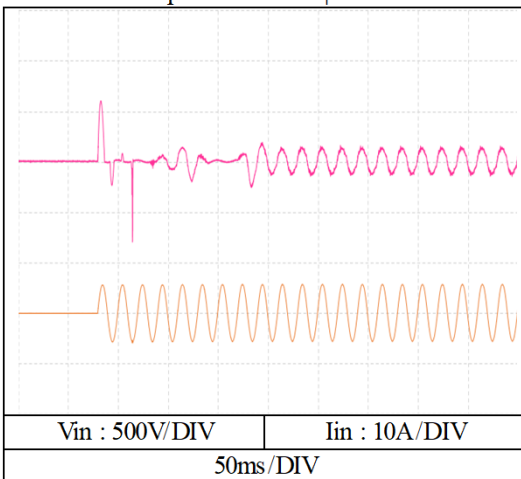

2-12. Input current harmonics

Condition Iout : 100%  
Istb : 100%  
Cooling : Convection cooling

Ta : 25°C

24V

Vin : 100VAC

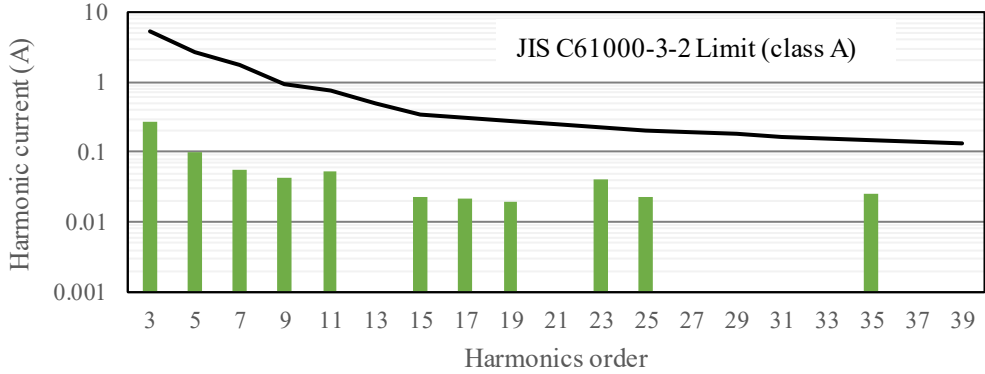

Vin : 230VAC

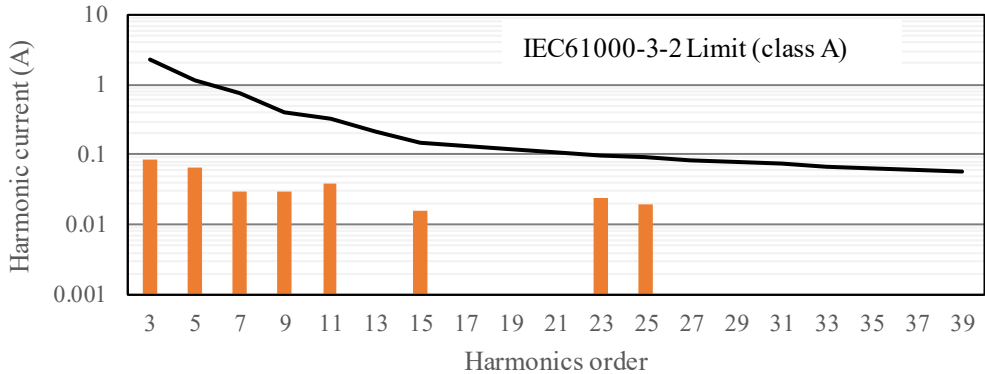

2-13. Input current waveform

Condition Iout : 100%  
Istb : 100%  
Cooling : Convection cooling

Ta : 25°C

24V

Vin : 100VAC

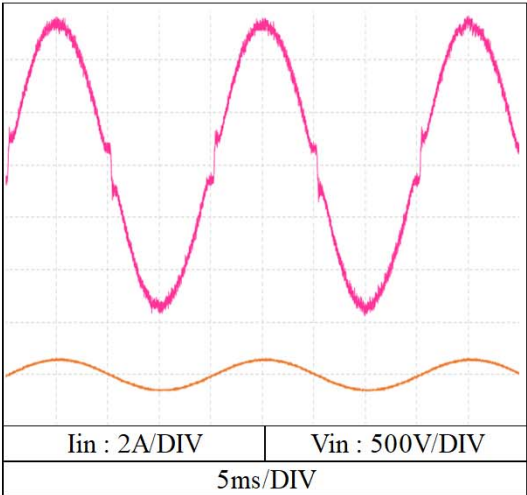

Vin : 200VAC

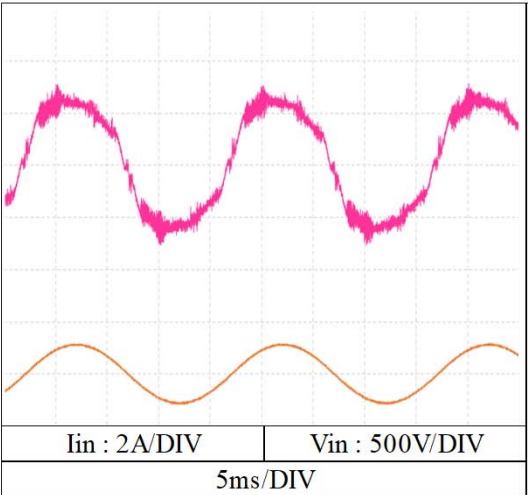



2-14. Leakage current characteristics

Condition Iout : 0% ---  
                  100% —  
                  Istb : 100%  
                  Cooling : Convection cooling

Ta : 25°C

24V

f = 50Hz

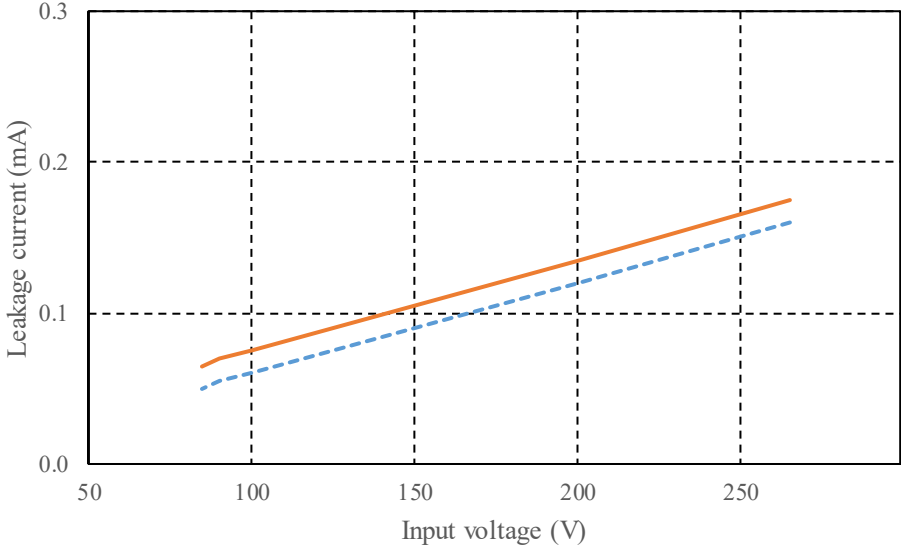

f = 60Hz

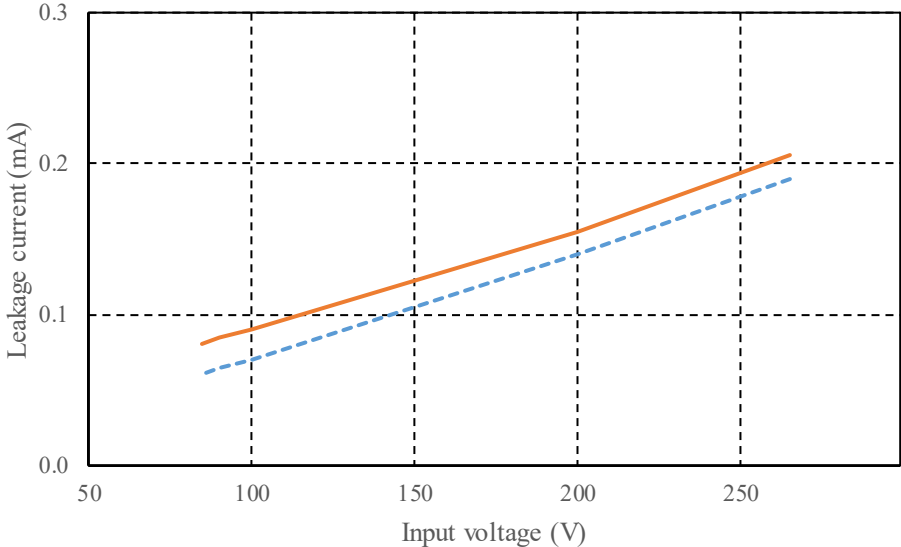

2-15. Output ripple and noise waveform

Condition Vin : 100VAC  
Iout : 100%  
Istb : 100%  
Cooling : Convection cooling

Ta : 25°C

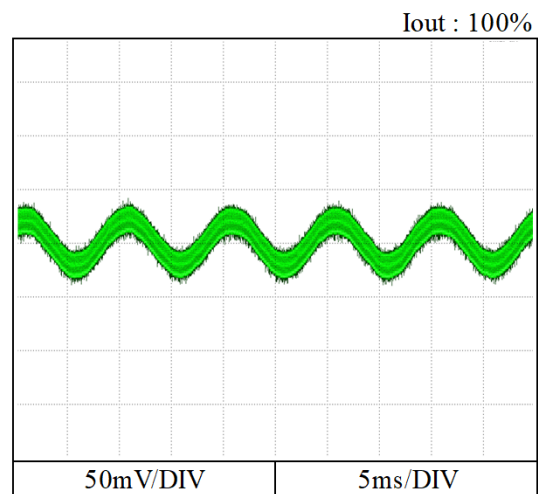
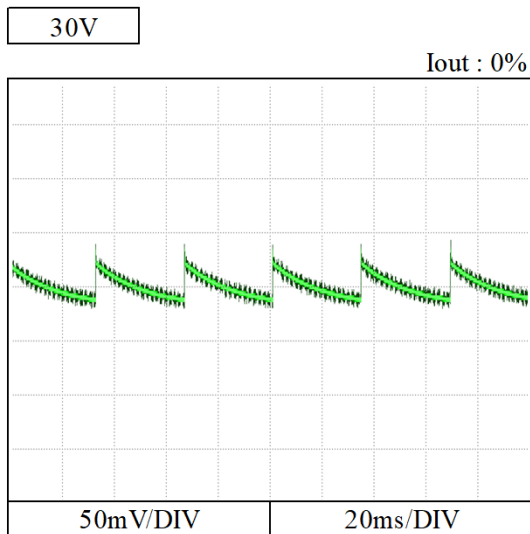
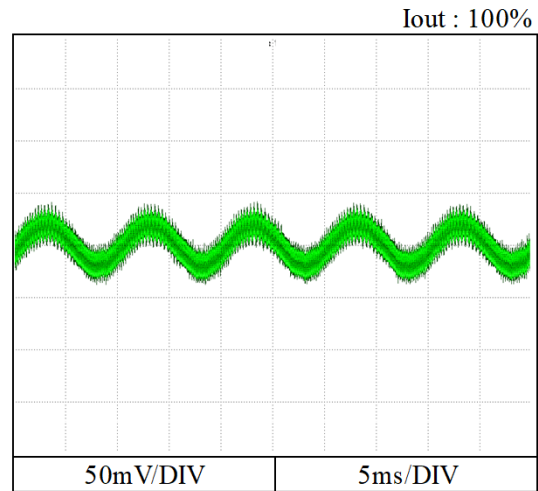
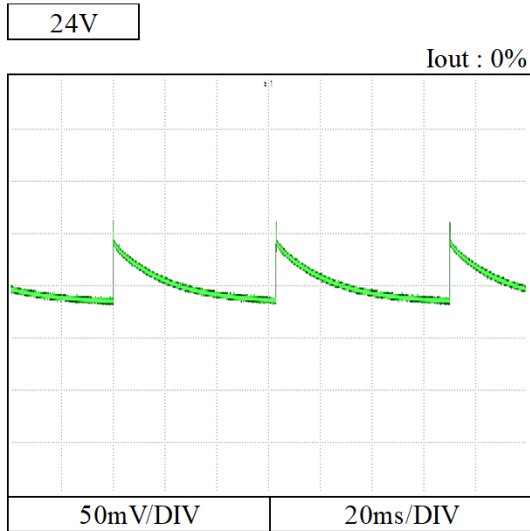

2-15. Output ripple and noise waveform

Condition Vin : 100VAC  
Iout : 100%  
Istb : 100%  
Cooling : Convection cooling

Ta : 25°C

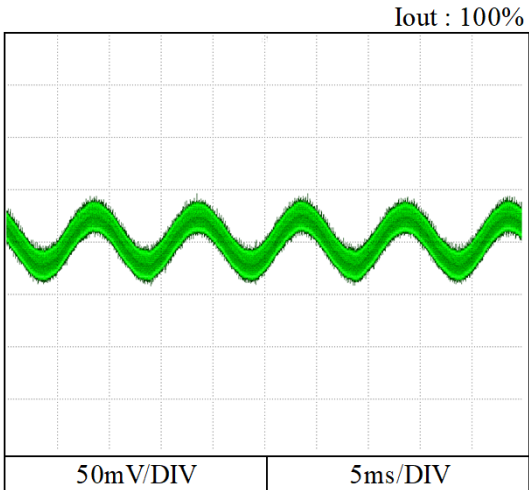
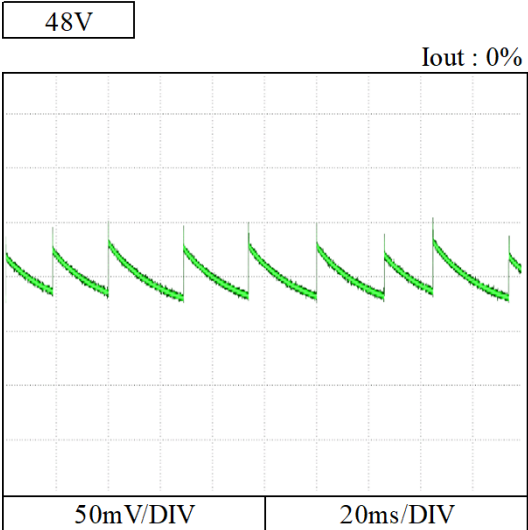
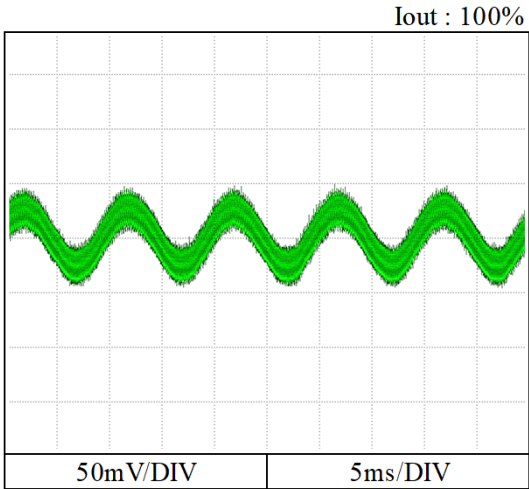
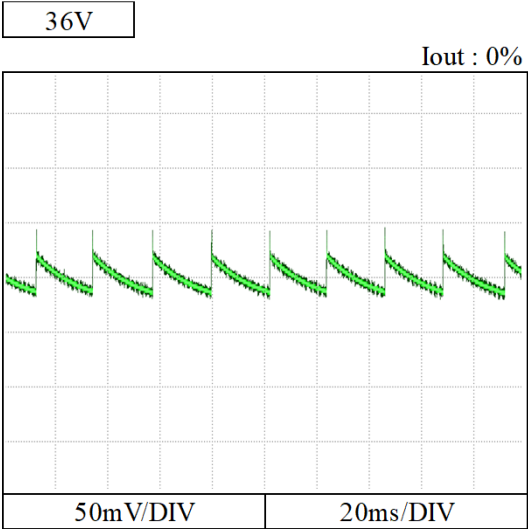

2-16. Electro-Magnetic Interference characteristics  
 Conducted Emission

Condition Vin : 230VAC  
 Iout : 100%  
 Istb : 100%  
 Cooling : Convection cooling

24V

Ta : 25°C

Ref. Data	Point A (0.2MHz)	
	Limit (dB)	Measure (dB)
QP	63.7	51.2
AV	53.7	49.1

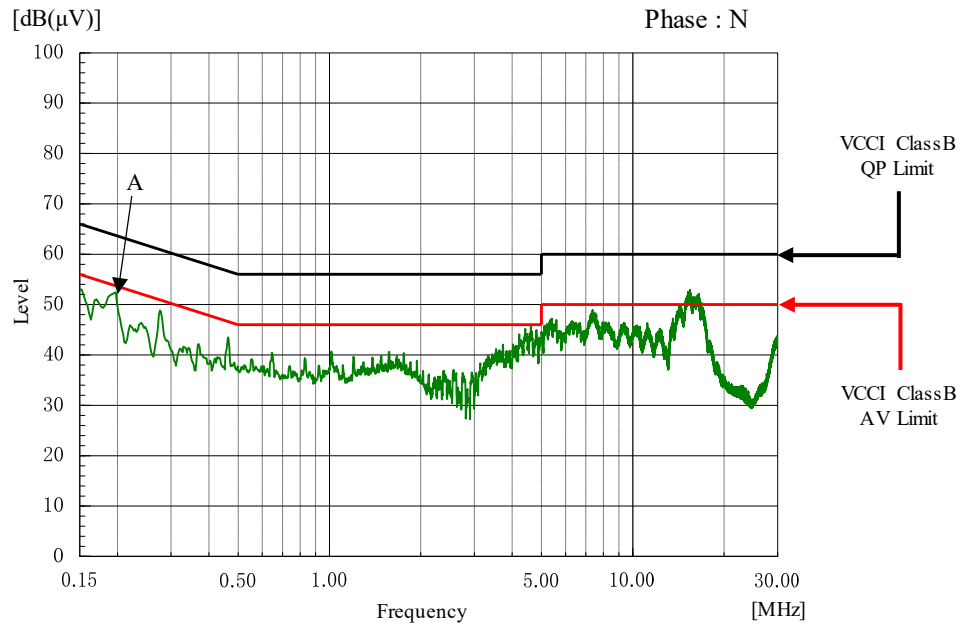

Ref. Data	Point B (0.2MHz)	
	Limit (dB)	Measure (dB)
QP	63.7	53.1
AV	53.7	49.3

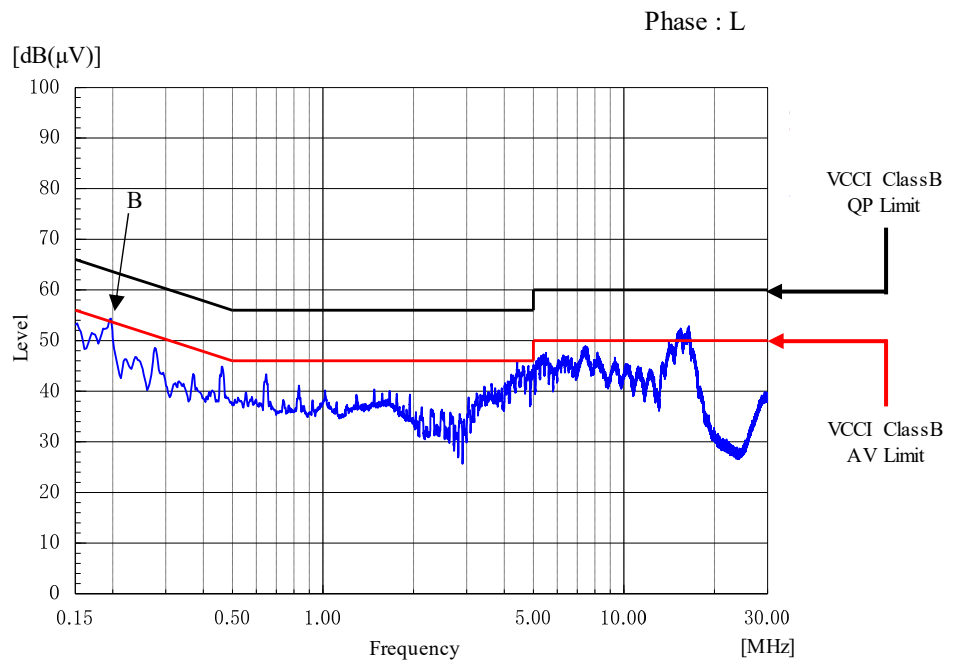

Limit of EN55011-B,EN55032-B,FCC-B are same as its VCCI class B.

2-16. Electro-Magnetic Interference characteristics  
 Conducted Emission

Condition Vin : 230VAC  
 Iout : 100%  
 Istb : 100%  
 Cooling : Convection cooling

30V

Ta : 25°C

Ref. Data	Point A (0.2MHz)	
	Limit (dB)	Measure (dB)
QP	63.7	51.5
AV	53.7	48.4

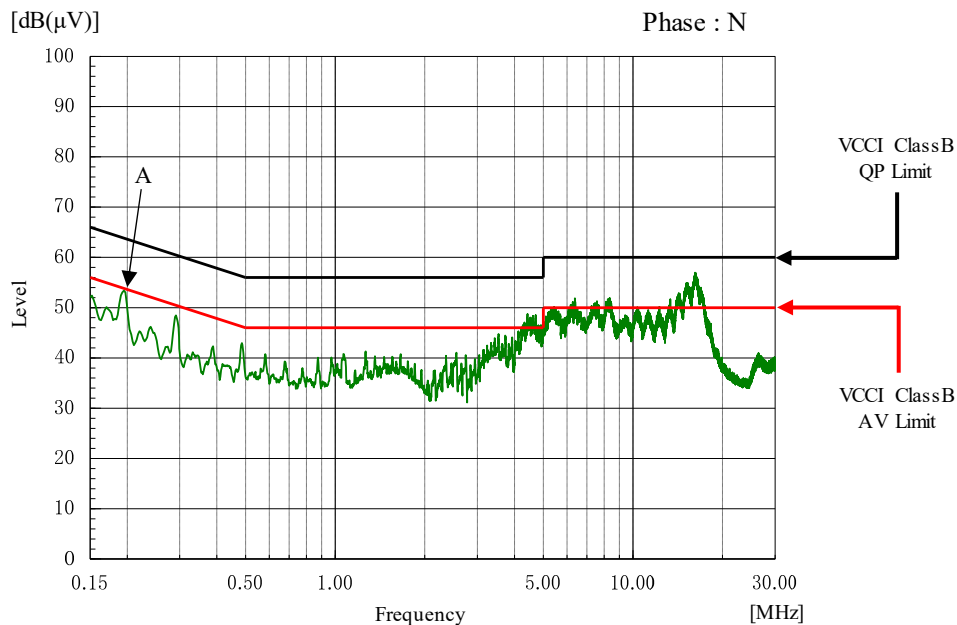

Ref. Data	Point B (0.2MHz)	
	Limit (dB)	Measure (dB)
QP	63.7	52.9
AV	53.7	48.7

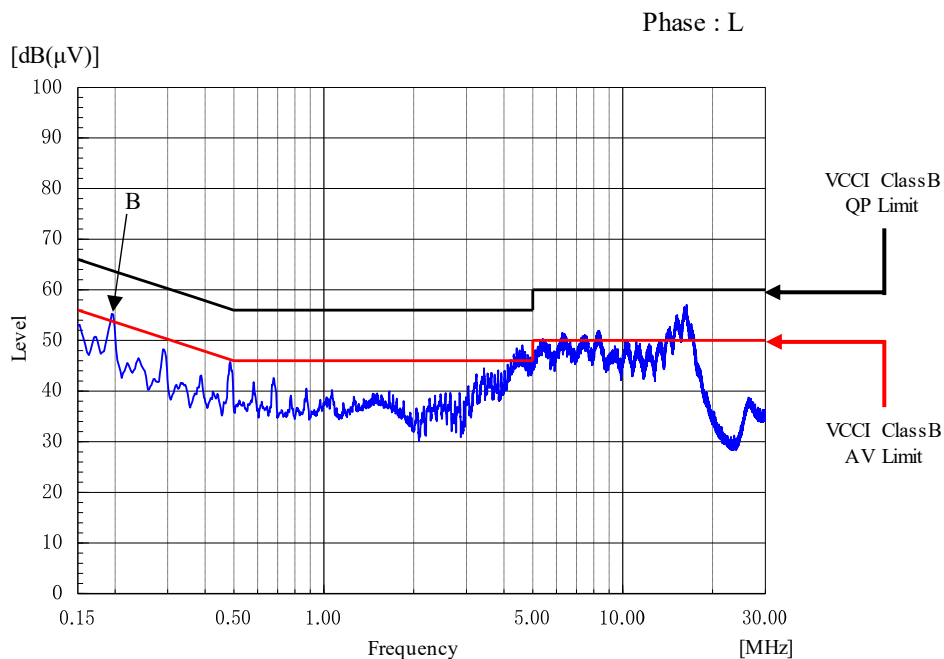

Limit of EN55011-B,EN55032-B,FCC-B are same as its VCCI class B.

2-16. Electro-Magnetic Interference characteristics  
 Conducted Emission

Condition Vin : 230VAC  
 Iout : 100%  
 Istb : 100%  
 Cooling : Convection cooling  
 Ta : 25°C

36V

Ref. Data	Point A (0.2MHz)	
	Limit (dB)	Measure (dB)
QP	63.7	50.1
AV	53.7	47.8

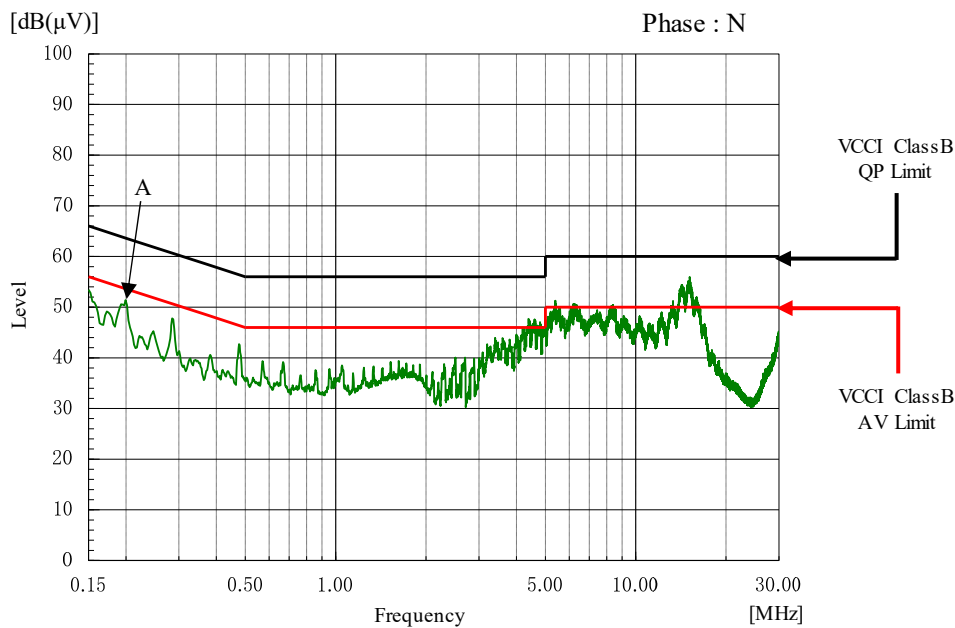

Ref. Data	Point B (0.2MHz)	
	Limit (dB)	Measure (dB)
QP	63.7	51.7
AV	53.7	48.1

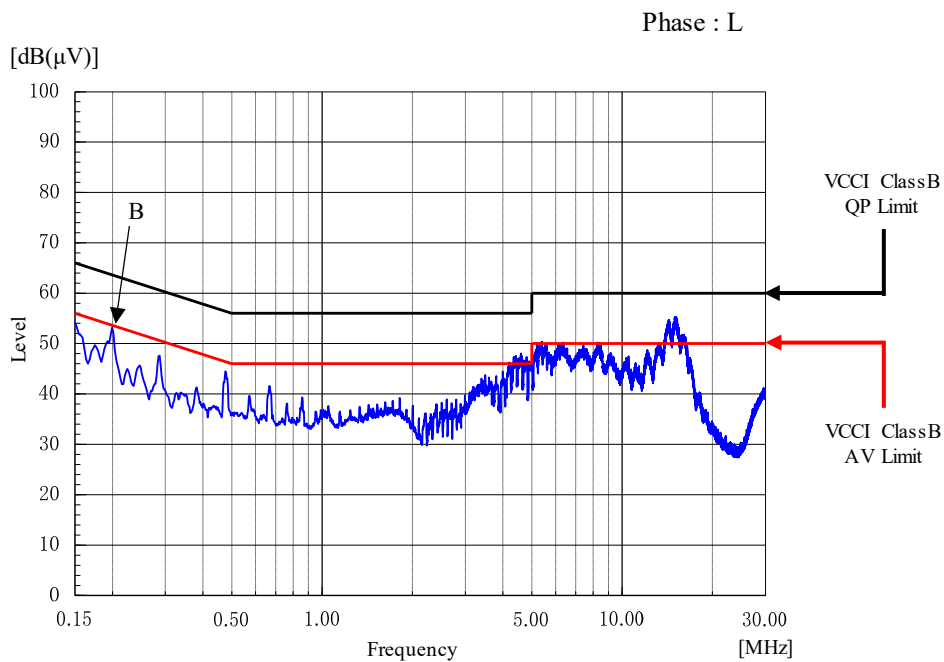

Limit of EN55011-B,EN55032-B,FCC-B are same as its VCCI class B.

2-16. Electro-Magnetic Interference characteristics  
 Conducted Emission

Condition Vin : 230VAC  
 Iout : 100%  
 Istb : 100%  
 Cooling : Convection cooling  
 Ta : 25°C

48V

Ref. Data	Point A (0.2MHz)	
	Limit (dB)	Measure (dB)
QP	63.7	50.6
AV	53.7	48.5

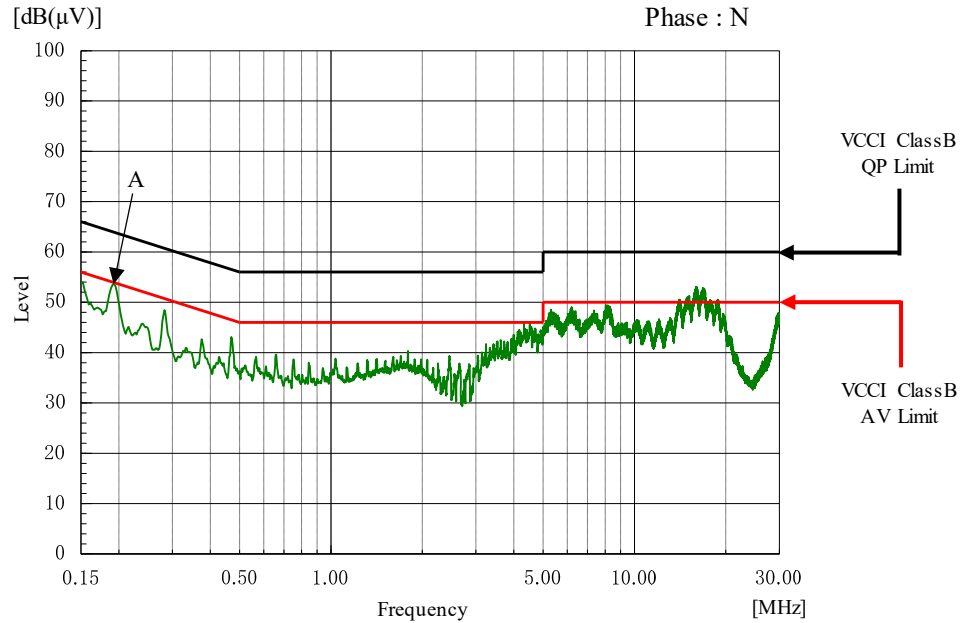

Ref. Data	Point B (0.2MHz)	
	Limit (dB)	Measure (dB)
QP	63.7	52.5
AV	53.7	48.7

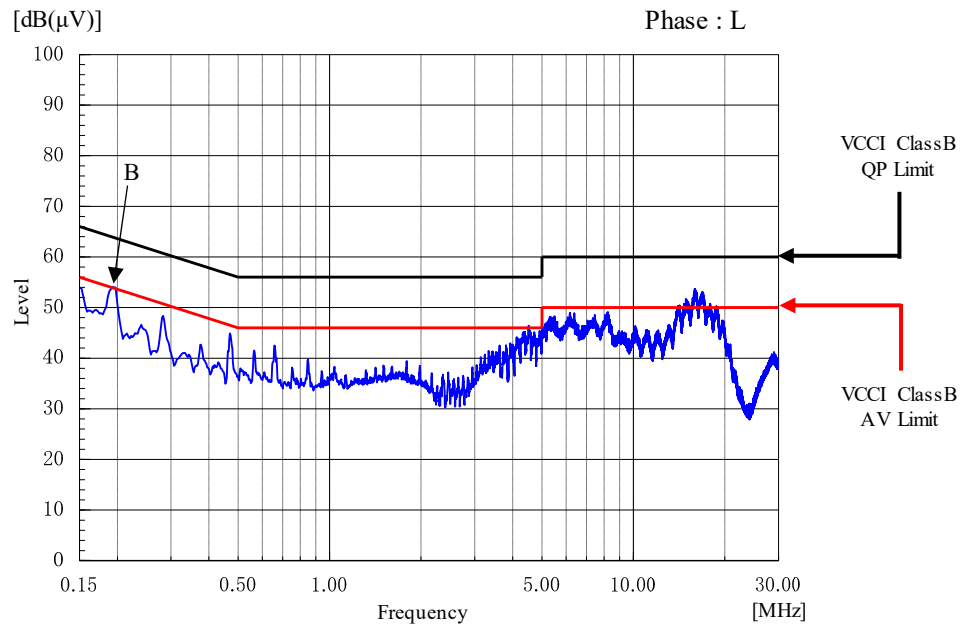

Limit of EN55011-B,EN55032-B,FCC-B are same as its VCCI class B.

Radiated Emission

Condition Vin : 230VAC  
Iout : 100%  
Istb : 100%  
Cooling : Convection cooling  
Ta : 25°C

24V

Horizontal

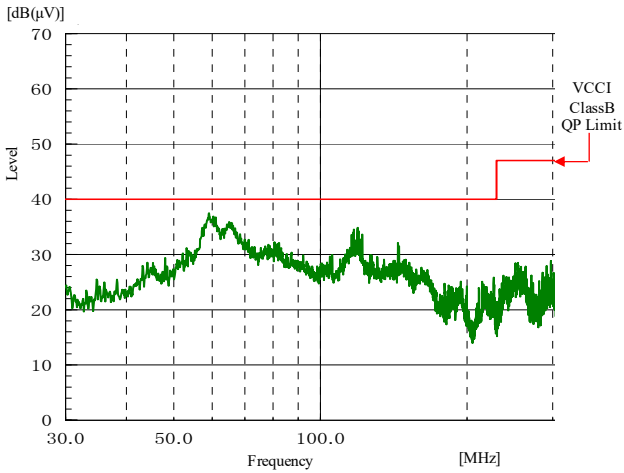

Vertical

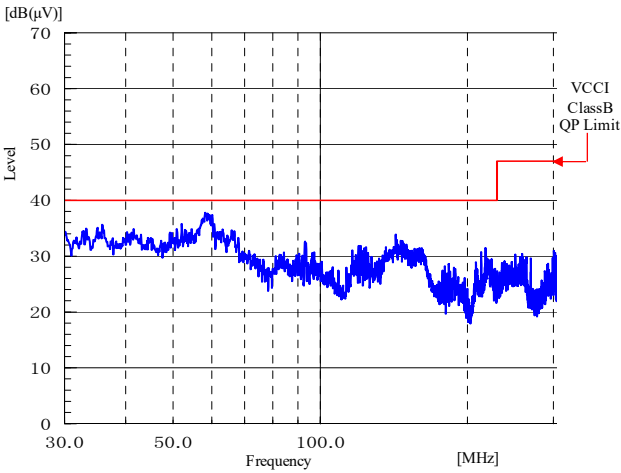

30V

Horizontal

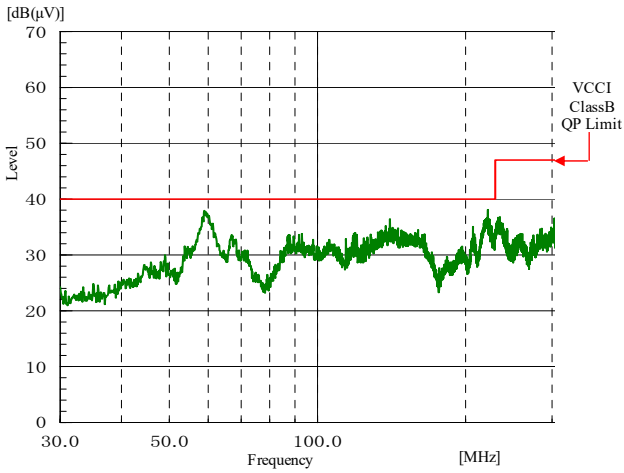

Vertical

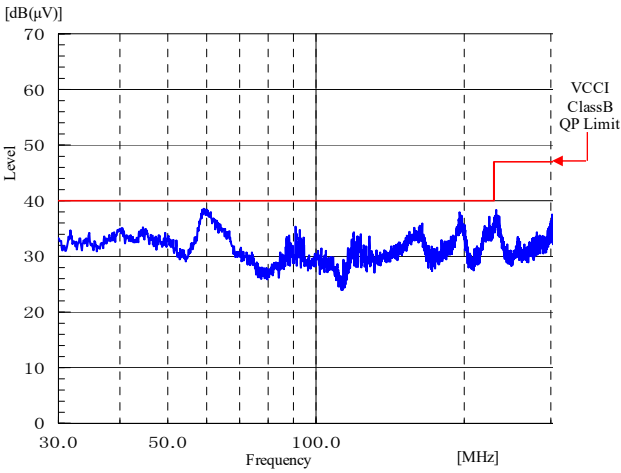

Limit of EN55011-B,EN55032-B are same as its VCCI class B.

Indication is peak values.



Radiated Emission

Condition Vin : 230VAC  
Iout : 100%  
Istb : 100%  
Cooling : Convection cooling  
Ta : 25°C

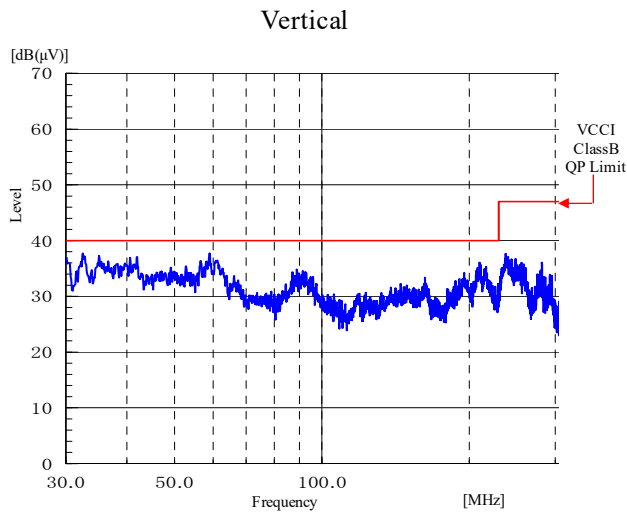
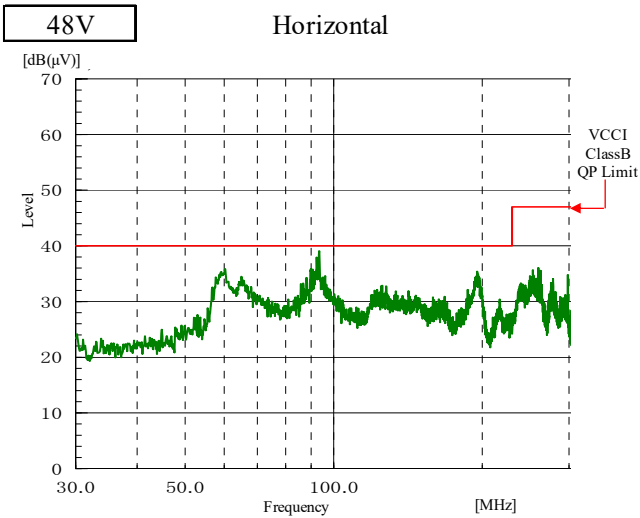
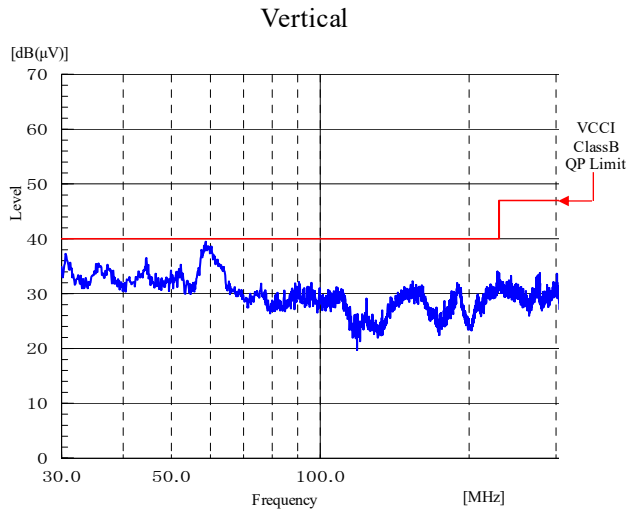
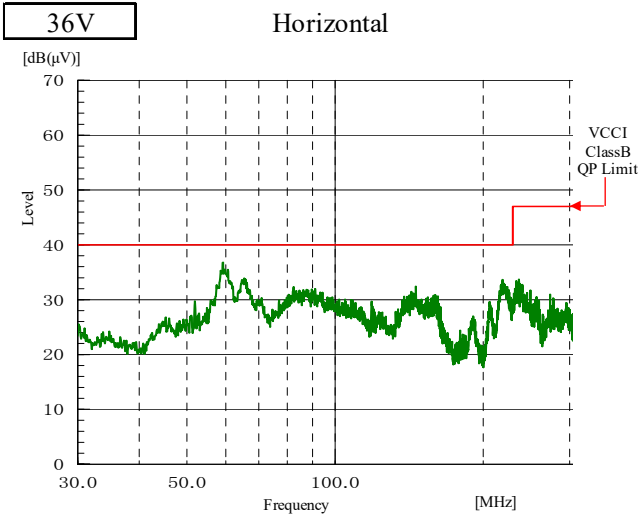

Limit of EN55011-B,EN55032-B are same as its VCCI class B.

Indication is peak values.