

HWS80A

EVALUATION DATA

型式データ

INDEX

1. 測定方法	Evaluation Method	PAGE
1.1	測定回路 Circuit used for determination	
	測定回路1 Circuit 1 used for determination	T-1
	静特性 Steady state data	
	通電ドリフト特性 Warm up voltage drift characteristics	
	出力保持時間特性 Hold up time characteristics	
	出力立ち上がり特性 Output rise characteristics	
	出力立ち下がり特性 Output fall characteristics	
	過電流保護特性 Over current protection (OCP) characteristics	
	過電圧保護特性 Over voltage protection (OVP) characteristics	
	過渡応答（入力急変）特性 Dynamic line response characteristics	
	入力電圧瞬停特性 Response to brown out characteristics	
	入力電流波形 Input current waveform	
	測定回路2 Circuit 2 used for determination	T-1
	過渡応答（負荷急変）特性 Dynamic load response characteristics	
	測定回路3 Circuit 3 used for determination	T-2
	入力サージ電流（突入電流）波形 Inrush current waveform	
	測定回路4 Circuit 4 used for determination	T-2
	リーク電流特性 Leakage current characteristics	
	測定回路5 Circuit 5 used for determination	T-2
	ON/OFFコントロール時立ち上がり、立ち下がり特性	
	Output rise, fall characteristics with ON/OFF Control	
	測定回路6 Circuit 6 used for determination	T-3
	出力リップル、ノイズ波形 Output ripple and noise waveform	
	測定構成 Configuration used for determination	T-3
	EMI特性 Electro-Magnetic Interference characteristics	
	(a) 雑音端子電圧（帰還ノイズ） Conducted Emission	
	(b) 雑音電界強度（放射ノイズ） Radiated Emission	
1.2	使用測定機器 List of equipment used	T-4

2. 特性データ Characteristics

2.1 静特性 Steady state data

(1) 入力・負荷・温度変動／出力起動・遮断電圧

Regulation - line and load, Temperature drift / Start up voltage and Drop out voltage T-5

(2) リップルノイズ電圧対入力電圧

Ripple noise voltage vs. Input voltage..... T-6

(3) 効率・力率対出力電流 Efficiency and Power factor vs. Output current T-7

(4) 入力電力対出力電流 Input power vs. Output current T-8

(5) 入力電流対出力電流 Input current vs. Output current T-9

2.2 通電ドリフト特性 Warm up voltage drift characteristics T-10

2.3 出力保持時間特性 Hold up time characteristics T-10

2.4 出力立ち上がり特性 Output rise characteristics T-11

2.5 出力立ち下がり特性 Output fall characteristics T-12

2.6 ON/OFFコントロール時出力立ち上がり、立ち下がり特性 (*)

Output rise, fall characteristics with ON/OFF Control T-13

2.7 過電流保護特性 Over current protection (OCP) characteristics T-14

2.8 過電圧保護特性 Over voltage protection (OVP) characteristics T-14

2.9 過渡応答（入力急変）特性 Dynamic line response characteristics T-15

2.10 過渡応答（負荷急変）特性 Dynamic load response characteristics T-16

2.11 入力電圧瞬停特性 Response to brown out characteristics T-17

2.12 入力サージ電流（突入電流）波形 Inrush current waveform T-18

2.13 高調波成分 Input current harmonics T-19

2.14 入力電流波形 Input current waveform T-19

2.15 リーク電流特性 Leakage current characteristics T-20

2.16 出力リップル、ノイズ波形 Output ripple and noise waveform T-21

2.17 リモートコントロールOFF時入力電力・入力電流対入力電圧 (*)

Input power and Input current vs. Input voltage with Remote control OFF T-22

2.18 EMI特性 Electro-Magnetic Interference characteristics T-23～26

(*) 準標準品 HWS80A-*/R にて対応 For alternative standard model HWS80A-*/R

使用記号 Terminology used

	定義	Definition
Vin	入力電圧 Input voltage
Vout	出力電圧 Output voltage
Iin	入力電流 Input current
Iout	出力電流 Output current
Ta	周囲温度 Ambient temperature
f	周波数 Frequency

1. 測定方法 Evaluation Method

1.1 測定回路 Circuit used for determination

測定回路1 Circuit 1 used for determination

- 静特性 Steady state data
- 通電ドリフト特性 Warm up voltage drift characteristics
- 出力保持時間特性 Hold up time characteristics
- 出力立ち上がり特性 Output rise characteristics
- 出力立ち下がり特性 Output fall characteristics
- 過電流保護特性 Over current protection (OCP) characteristics
- 過電圧保護特性 Over voltage protection (OVP) characteristics
- 過渡応答(入力急変)特性 Dynamic line response characteristics
- 入力電圧瞬停特性 Response to brown out characteristics
- 入力電流波形 Input current waveform

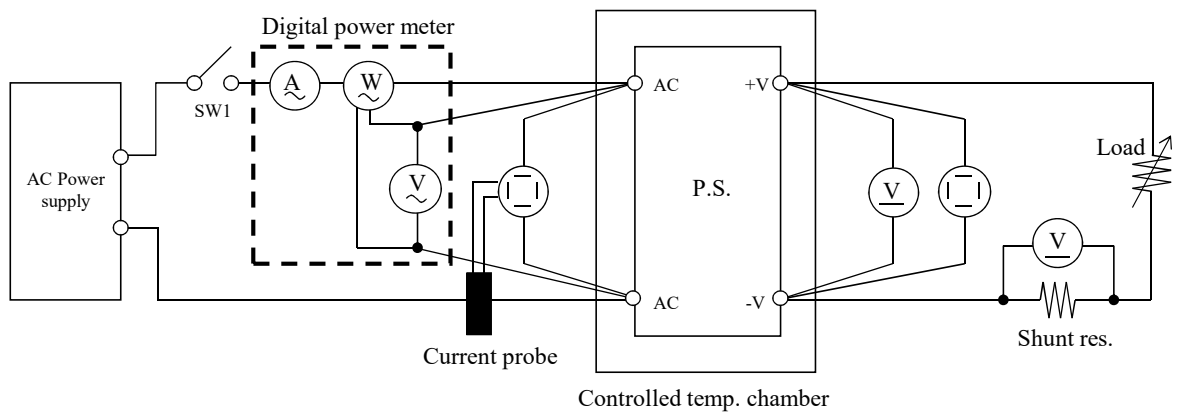

測定回路2 Circuit 2 used for determination

- 過渡応答(負荷急変)特性 Dynamic load response characteristics

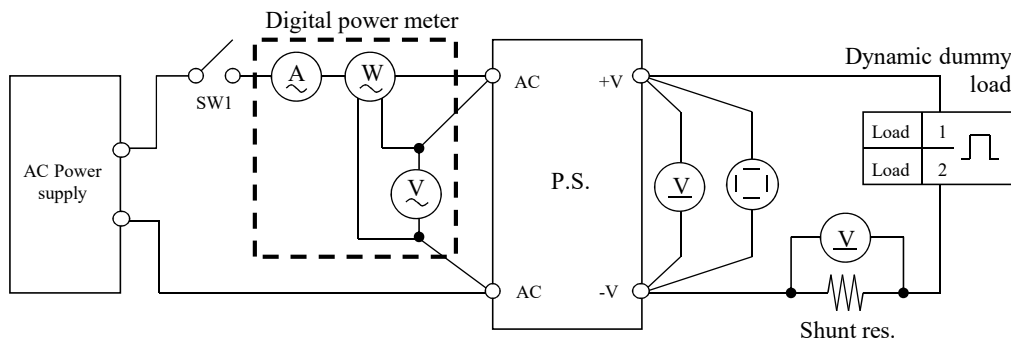

Output current waveform
I_{out} 50% <=> 100%

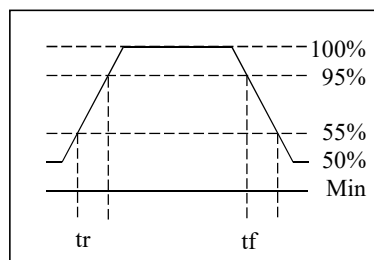

測定回路3 Circuit 3 used for determination

・入力サージ電流 (突入電流) 波形 Inrush current waveform

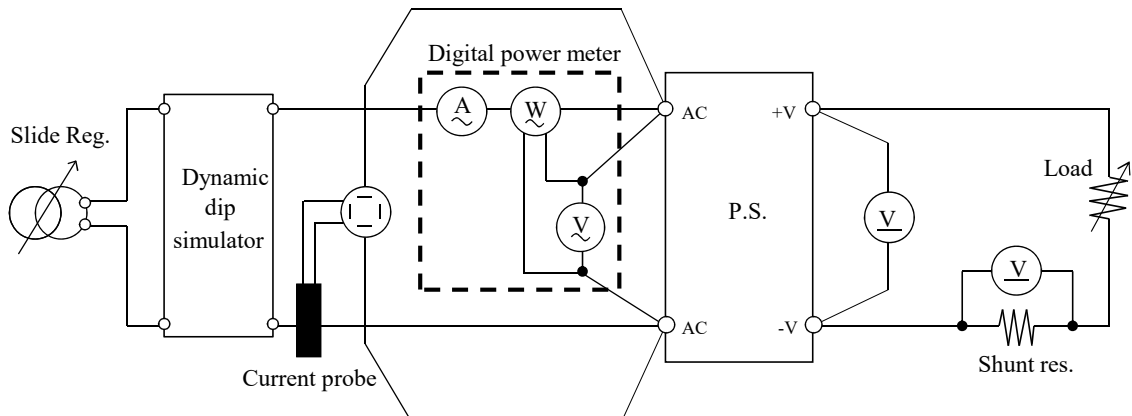

測定回路4 Circuit 4 used for determination

・リーク電流特性 Leakage current characteristics

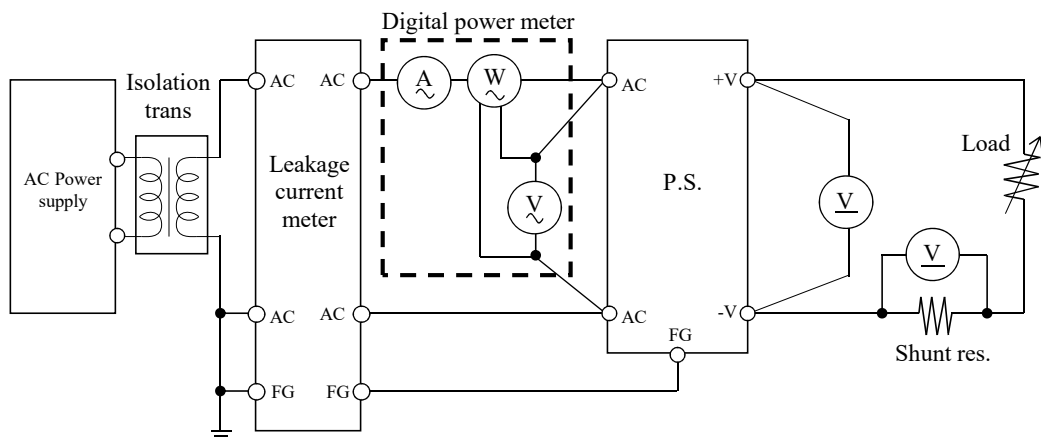

測定回路5 Circuit 5 used for determination

・ON/OFFコントロール時出力立ち上がり、立ち下がり特性
Output rise, fall characteristics with ON/OFF Control

準標準品 HWS80A-*/R にて対応

For alternative standard model HWS80A-*/R

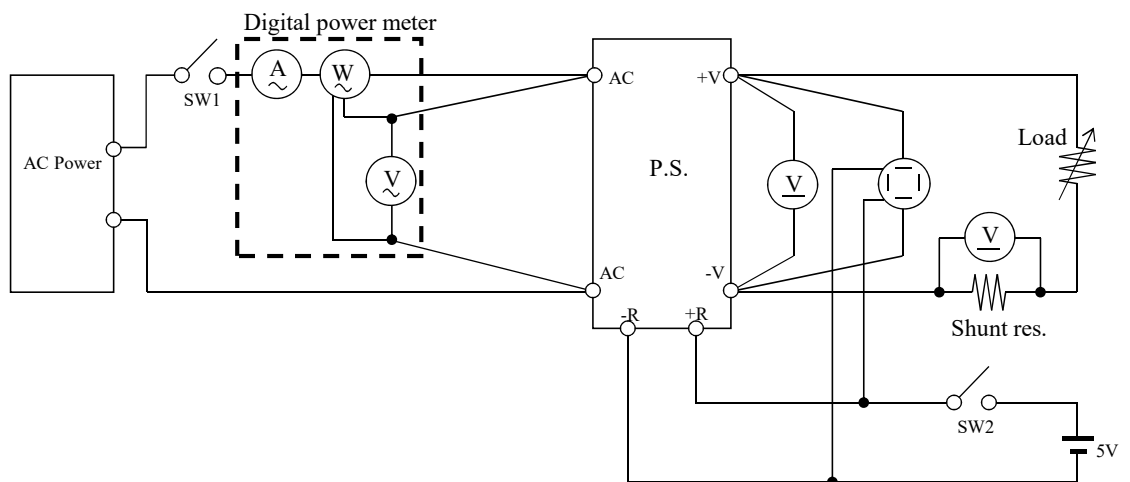

測定回路6 Circuit 5 used for determination

・出力リップル、ノイズ波形 Output ripple and noise waveform

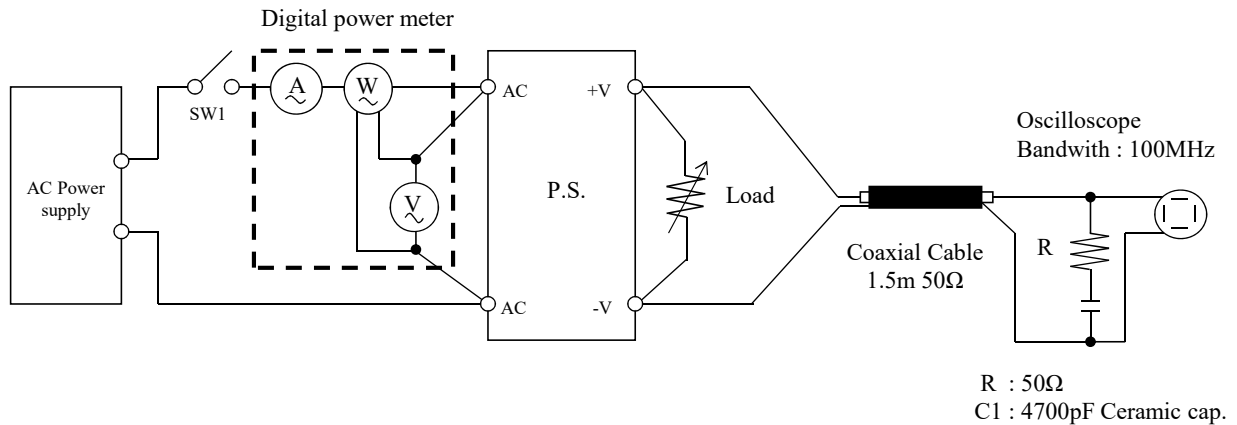

測定構成 Configuration used for determination

・EMI特性 Electro-Magnetic Interference characteristics

(a) 雑音端子電圧 (帰還ノイズ)
Conducted Emission

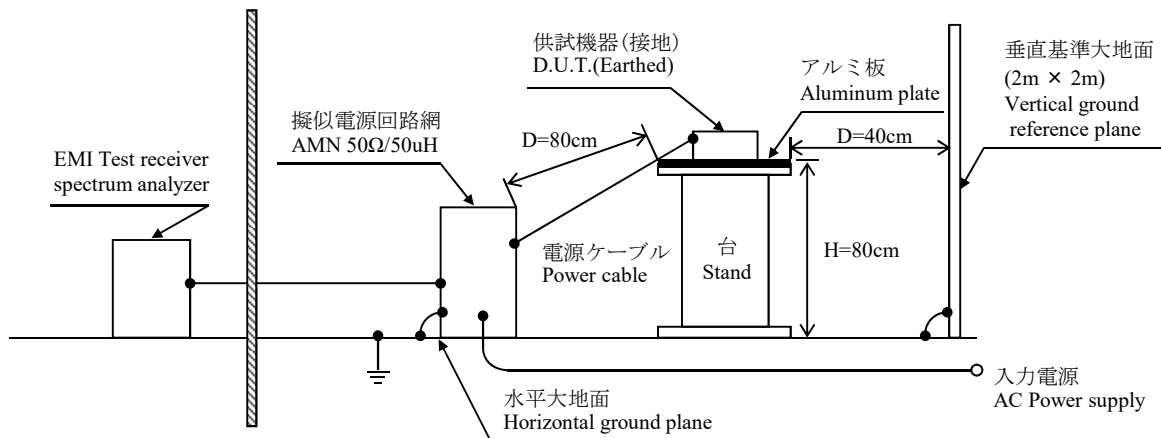

(b) 雑音電界強度 (放射ノイズ)
Radiated Emission

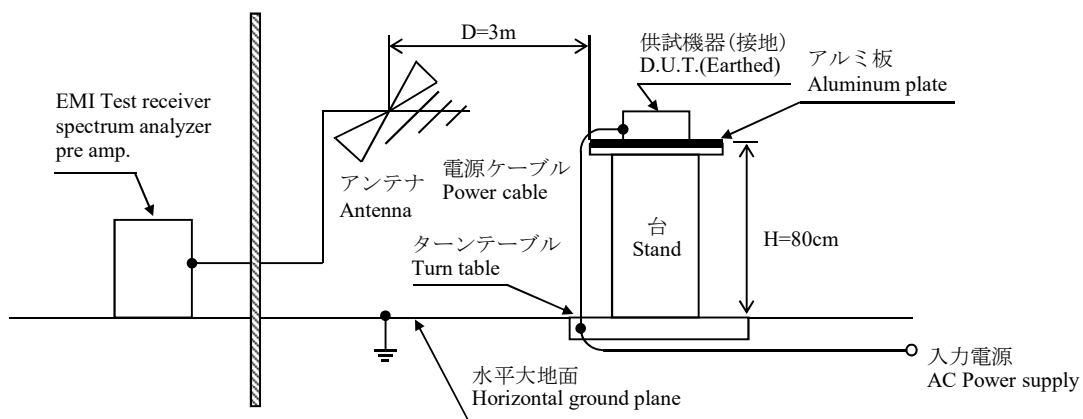

1.2 使用測定機器 List of equipment used

	EQUIPMENT USED	MANUFACTURER	MODEL NO.
1	DIGITAL STORAGE OSCILLOSCOPE	YOKOGAWA ELECT.	DL9040L / DLM2054
2	DIGITAL MULTIMETER	AGILENT	34970A
3	DIGITAL POWER METER	HIOKI	3334
4	DIGITAL POWER METER	YOKOGAWA ELECT.	WT110 / WT210
5	CURRENT PROBE	YOKOGAWA ELECT.	701928 / 701930
6	DYNAMIC DUMMY LOAD	TAKASAGO	FK-400L / FK-600L
7	DYNAMIC DUMMY LOAD	KIKUSUI	PLZ1004W / PLZ150U
8	DUMMY LOAD	PCN	PHF250 SERIES
9	ISOLATION TRANS	MATSUNAGA	3WTC-50K
10	CVCF	TAKASAGO	AA2000XG
11	CVCF	KIKUSUI	PCR4000L
12	CVCF	NF	ES10000S
13	LEAKAGE CURRENT METER	HIOKI	3156
14	DYNAMIC DIP SIMULATOR	TAKAMISAWA	PSA-210
15	CONTROLLED TEMP. CHAMBER	ESPEC	SU-261 / SH-240
16	EMI TEST RECEIVER / SPECTRUM ANALYZER	ROHDE & SCHWARZ	ESCI
17	PRE AMP.	SONOMA	310N
18	AMN	SCHWARZBECK	NNLK8121
19	ANTENNA	SCHWARZBECK	CBL6111D
20	HARMONIC / FLICKER ANALYZER	KIKUSUI	KHA1000
21	SINGLE-PHASE MASTER	NF	4420
22	REFERENCE IMPEDANCE NETWORK 20A	NF	4150
23	MULTI OUTLET UNIT	KIKUSUI	OT01-KHA

2. 特性データ Characteristics

2.1 静特性 Steady state data

(1) 入力・負荷・温度変動／出力起動・遮断電圧

Regulation - line and load, Temperature drift / Start up voltage and Drop out voltage

5V		1. Regulation - line and load				Condition Ta : 25 °C	
Iout \ Vin	85VAC	100VAC	200VAC	265VAC	line regulation		
0%	5.045V	5.045V	5.045V	5.045V	0mV	0.000%	
50%	5.043V	5.043V	5.043V	5.043V	0mV	0.000%	
100%	5.042V	5.042V	5.042V	5.042V	0mV	0.000%	
load	3mV	3mV	3mV	3mV			
regulation	0.060%	0.060%	0.060%	0.060%			
		2. Temperature drift				Conditions Vin : 100 VAC Iout : 100 %	
Ta	-10°C	+25°C	+50°C	temperature stability			
Vout	5.037V	5.042V	5.044V	7mV	0.140%		
		3. Start up voltage and Drop out voltage				Conditions Ta : 25 °C Iout : 100 %	
Start up voltage (Vin)		77VAC					
Drop out voltage (Vin)		52VAC					

12V		1. Regulation - line and load				Condition Ta : 25 °C	
Iout \ Vin	85VAC	100VAC	200VAC	265VAC	line regulation		
0%	12.005V	12.005V	12.005V	12.005V	0mV	0.000%	
50%	12.003V	12.003V	12.003V	12.003V	0mV	0.000%	
100%	12.002V	12.002V	12.002V	12.002V	0mV	0.000%	
load	3mV	3mV	3mV	3mV			
regulation	0.025%	0.025%	0.025%	0.025%			
		2. Temperature drift				Conditions Vin : 100 VAC Iout : 100 %	
Ta	-10°C	+25°C	+50°C	temperature stability			
Vout	11.995V	12.002V	11.984V	18mV	0.150%		
		3. Start up voltage and Drop out voltage				Conditions Ta : 25 °C Iout : 100 %	
Start up voltage (Vin)		77VAC					
Drop out voltage (Vin)		53VAC					

24V		1. Regulation - line and load				Condition Ta : 25 °C	
Iout \ Vin	85VAC	100VAC	200VAC	265VAC	line regulation		
0%	24.084V	24.084V	24.084V	24.084V	0mV	0.000%	
50%	24.080V	24.080V	24.081V	24.081V	1mV	0.004%	
100%	24.080V	24.081V	24.080V	24.080V	1mV	0.004%	
load	4mV	4mV	4mV	4mV			
regulation	0.017%	0.017%	0.017%	0.017%			
		2. Temperature drift				Conditions Vin : 100 VAC Iout : 100 %	
Ta	-10°C	+25°C	+50°C	temperature stability			
Vout	24.046V	24.081V	24.057V	35mV	0.146%		
		3. Start up voltage and Drop out voltage				Conditions Ta : 25 °C Iout : 100 %	
Start up voltage (Vin)		75VAC					
Drop out voltage (Vin)		52VAC					

(2) リプルノイズ電圧対入力電圧 Ripple noise voltage vs. Input voltage

Conditions Iout: 100 %
Ta: -10 °C ---
25 °C -.-
50 °C —

5V

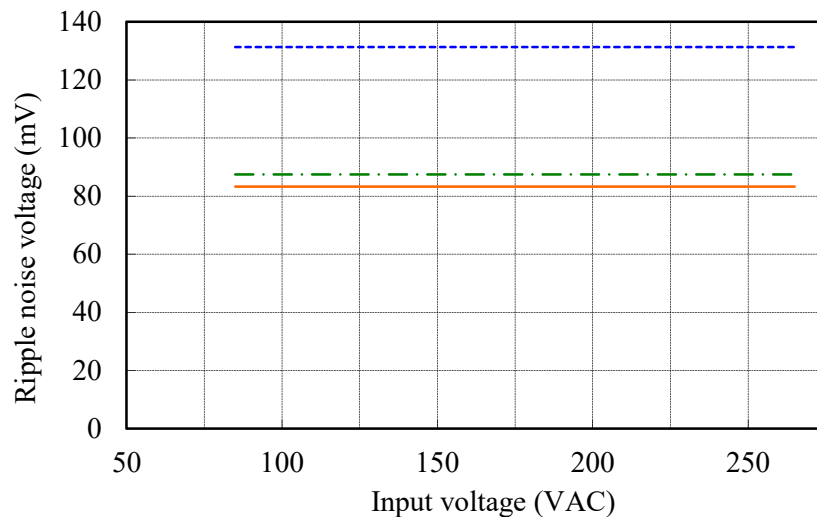

12V

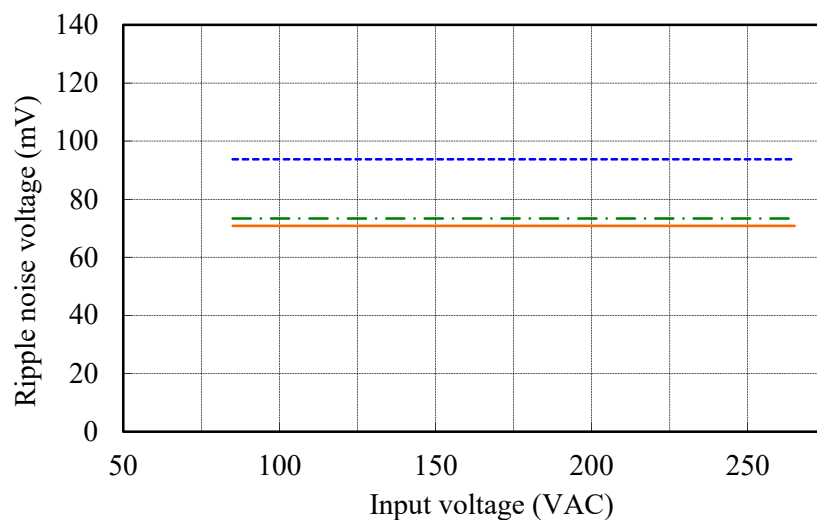

24V

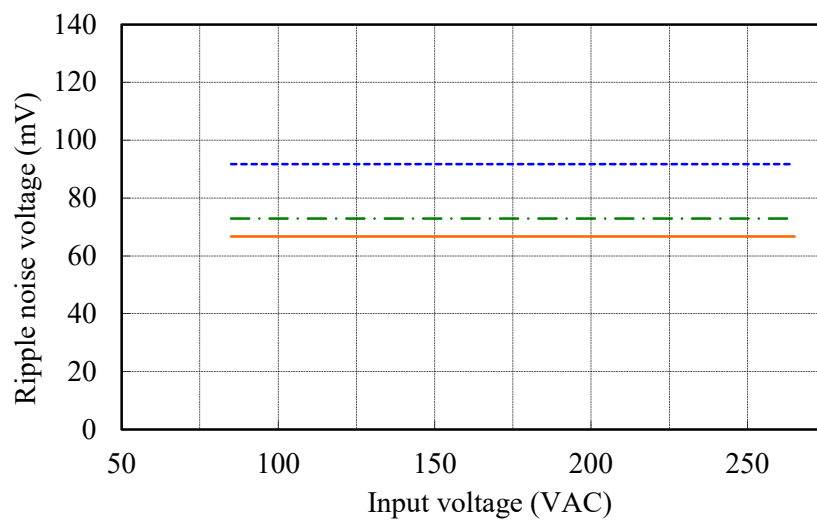

(3) 効率・力率対出力電流

Efficiency and Power factor vs. Output current

Conditions Vin : 85 VAC ---
 100 VAC - - -
 200 VAC ———
 265 VAC - · - · -
 Ta : 25 °C

5V

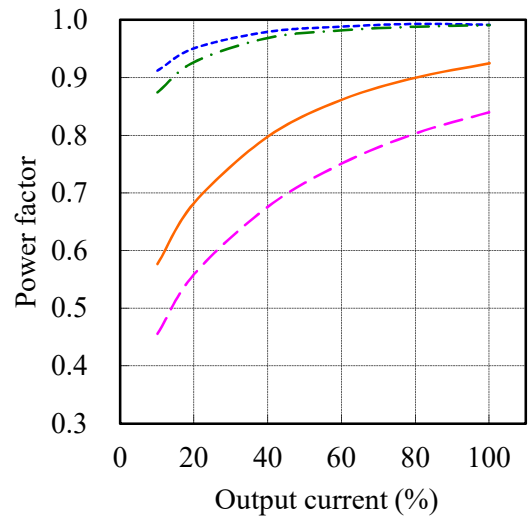
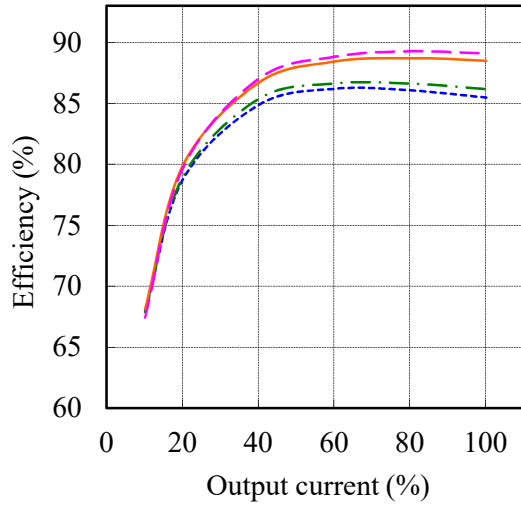

12V

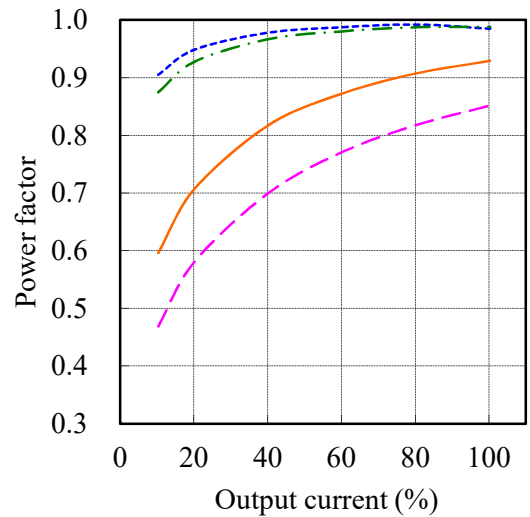
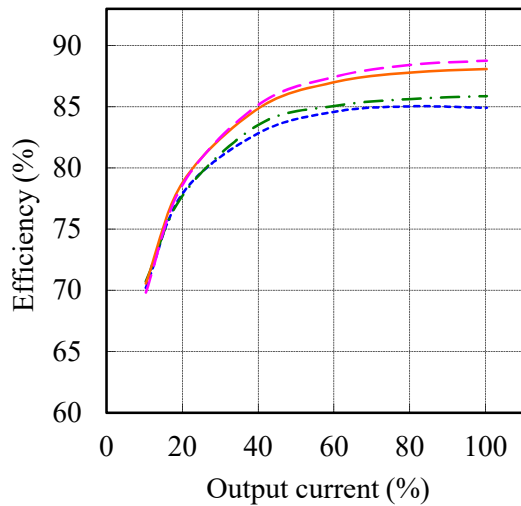

24V

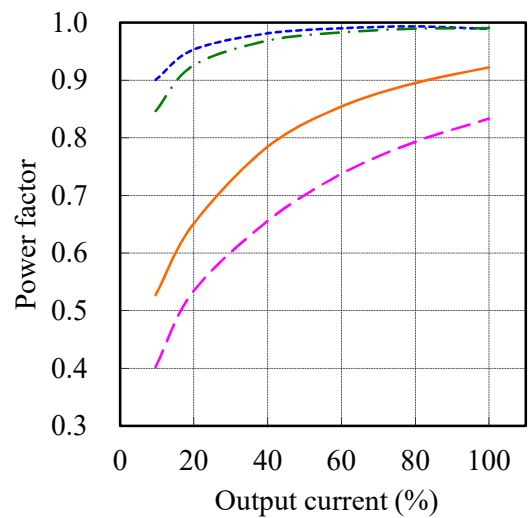
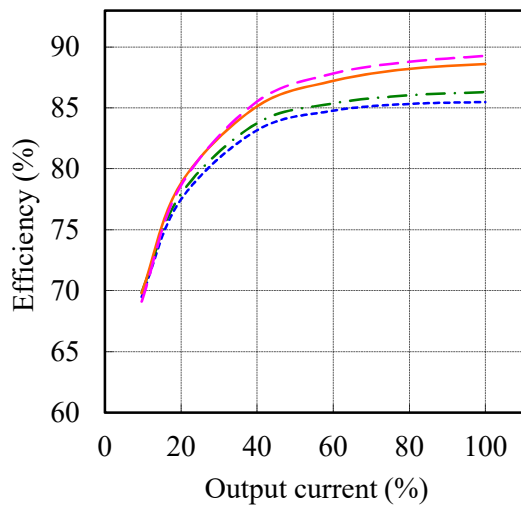

HWS80A

(4) 入力電力対出力電流 Input power vs. Output current

Conditions Vin : 85 VAC ---
 100 VAC - - -
 200 VAC ---
 265 VAC - - -
 Ta : 25 °C

5V

Vin	Input power
	Iout : 0%
85VAC	3.8W
100VAC	3.8W
200VAC	3.9W
265VAC	3.8W

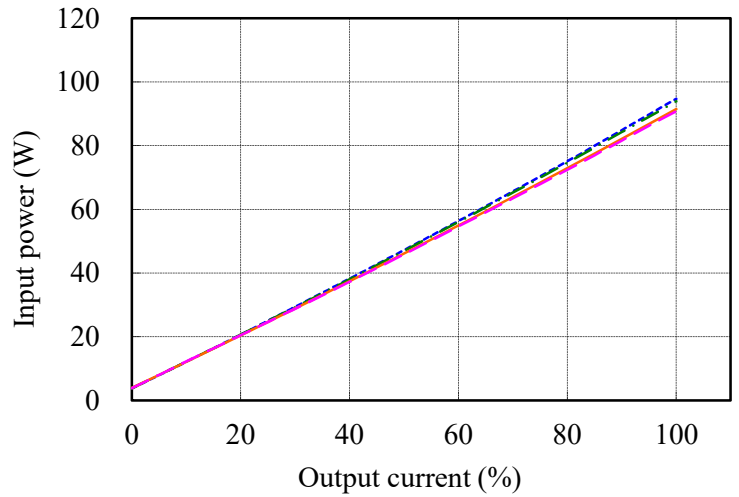

12V

Vin	Input power
	Iout : 0%
85VAC	1.9W
100VAC	2.4W
200VAC	2.3W
265VAC	2.2W

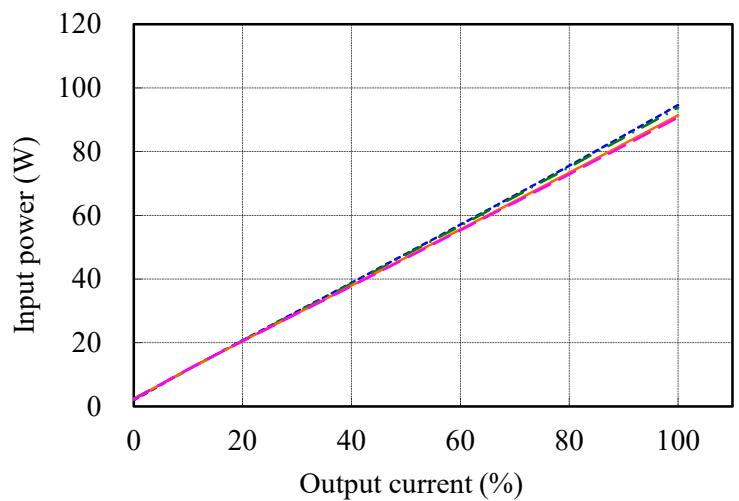

24V

Vin	Input power
	Iout : 0%
85VAC	2.1W
100VAC	2.5W
200VAC	2.3W
265VAC	2.2W

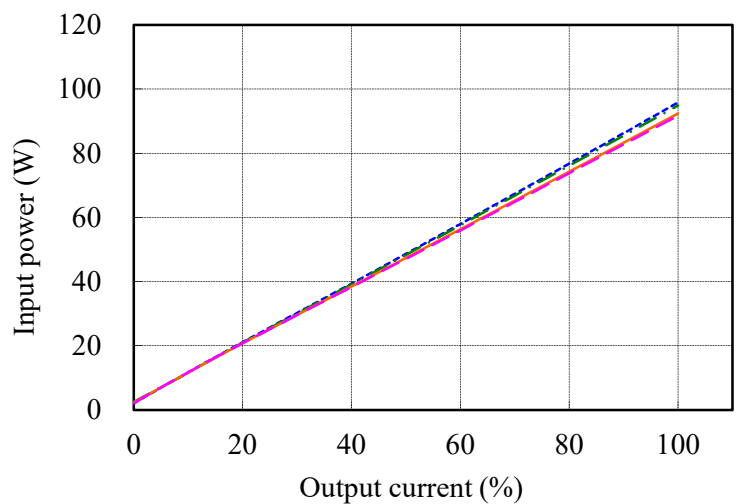

HWS80A

(5) 入力電流対出力電流 Input current vs. Output current

Conditions Vin : 85 VAC ---
 100 VAC -.-
 200 VAC —
 265 VAC -.-
 Ta : 25 °C

5V

Vin	Input current
	Iout : 0%
85VAC	0.06A
100VAC	0.05A
200VAC	0.05A
265VAC	0.06A

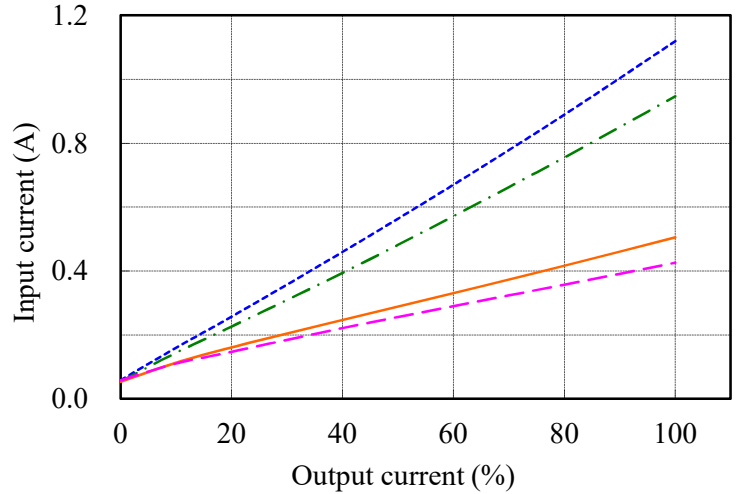

12V

Vin	Input current
	Iout : 0%
85VAC	0.04A
100VAC	0.05A
200VAC	0.05A
265VAC	0.06A

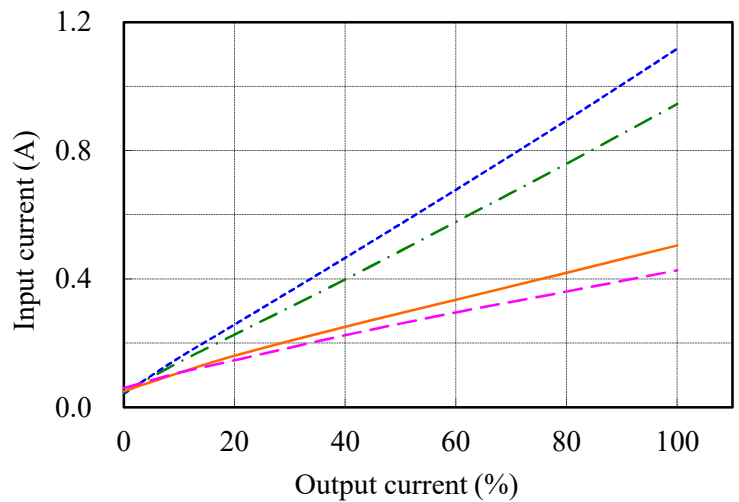

24V

Vin	Input current
	Iout : 0%
85VAC	0.04A
100VAC	0.04A
200VAC	0.05A
265VAC	0.06A

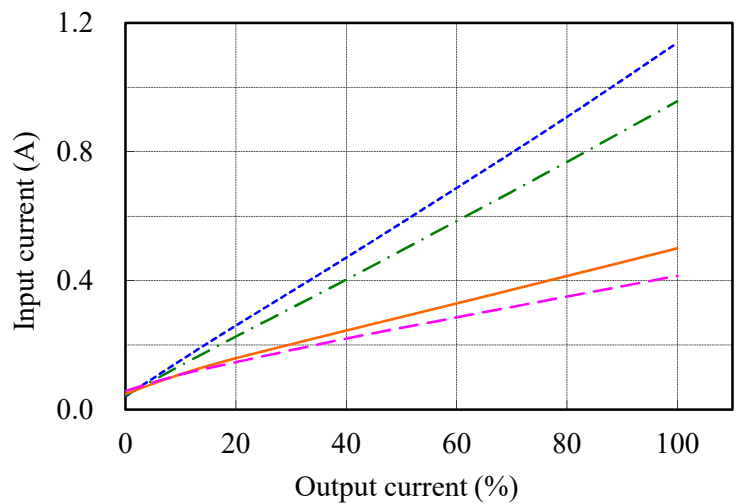

2.2 通電ドリフト特性

Warm up voltage drift characteristics

Conditions Vin : 100 VAC
Iout : 100 %
Ta : 25 °C

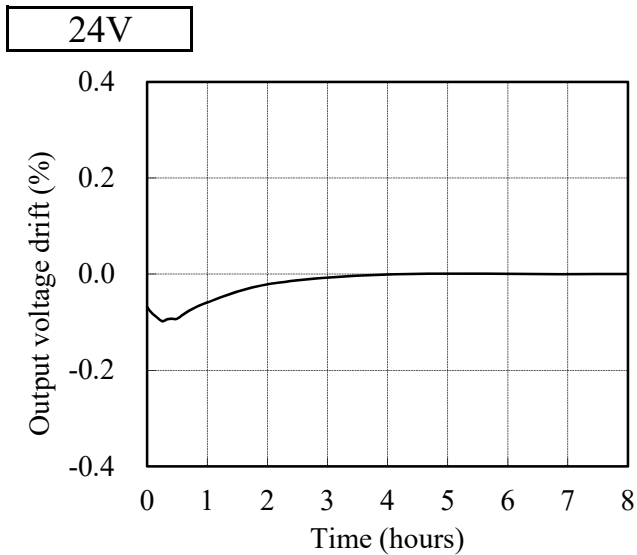
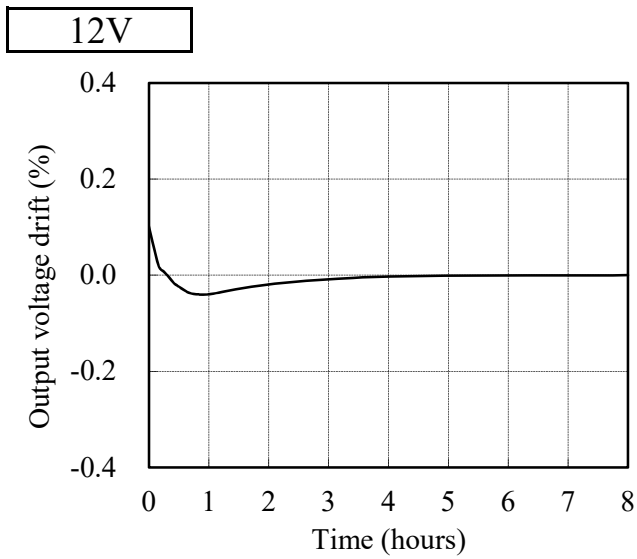
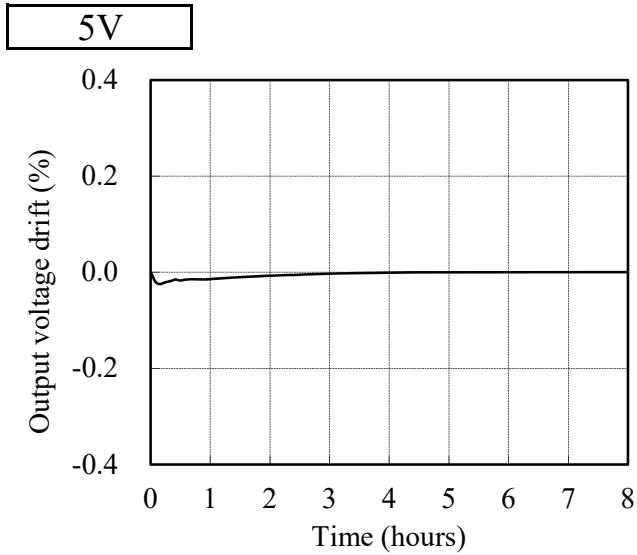

2.3 出力保持時間特性

Hold up time characteristics

Conditions Vin : 100 VAC (solid green line)
200 VAC (dashed orange line)
Ta : 25 °C

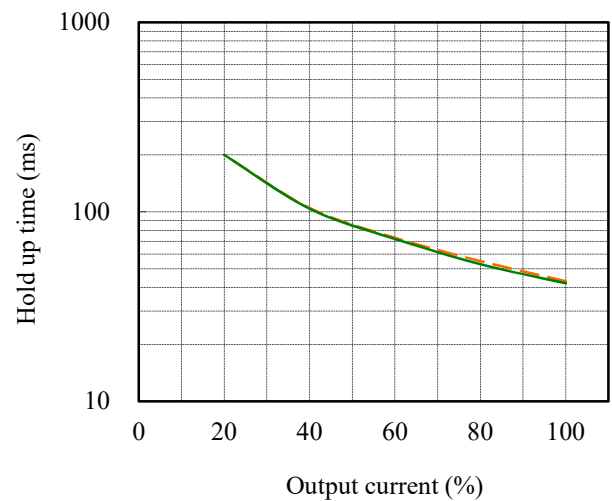
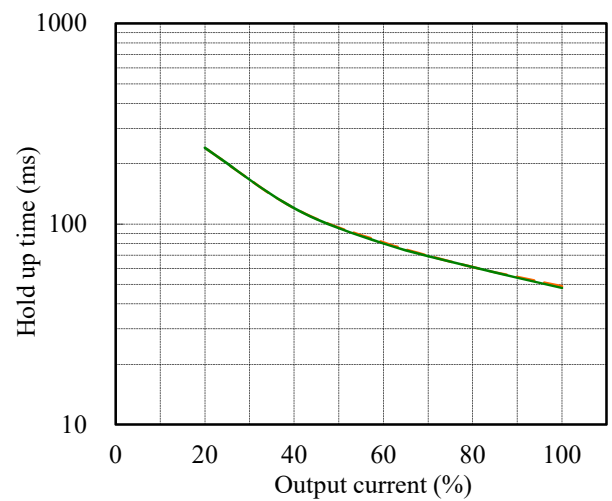
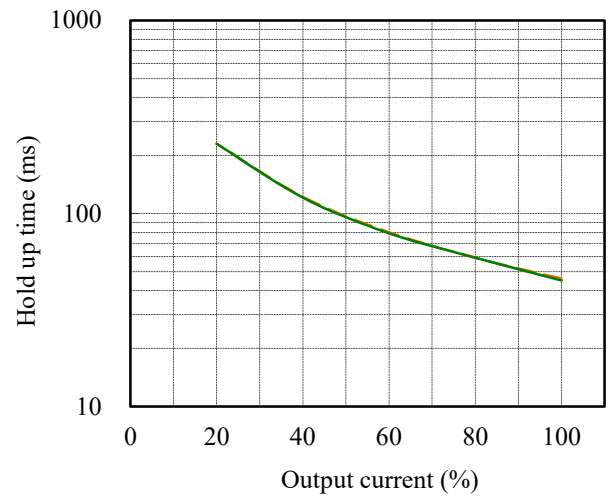

2.4 出力立ち上がり特性

Output rise characteristics

Conditions V_{in} : 85 VAC (A)
 100 VAC (B)
 200 VAC (C)
 265 VAC (D)
 T_a : 25 °C

5V

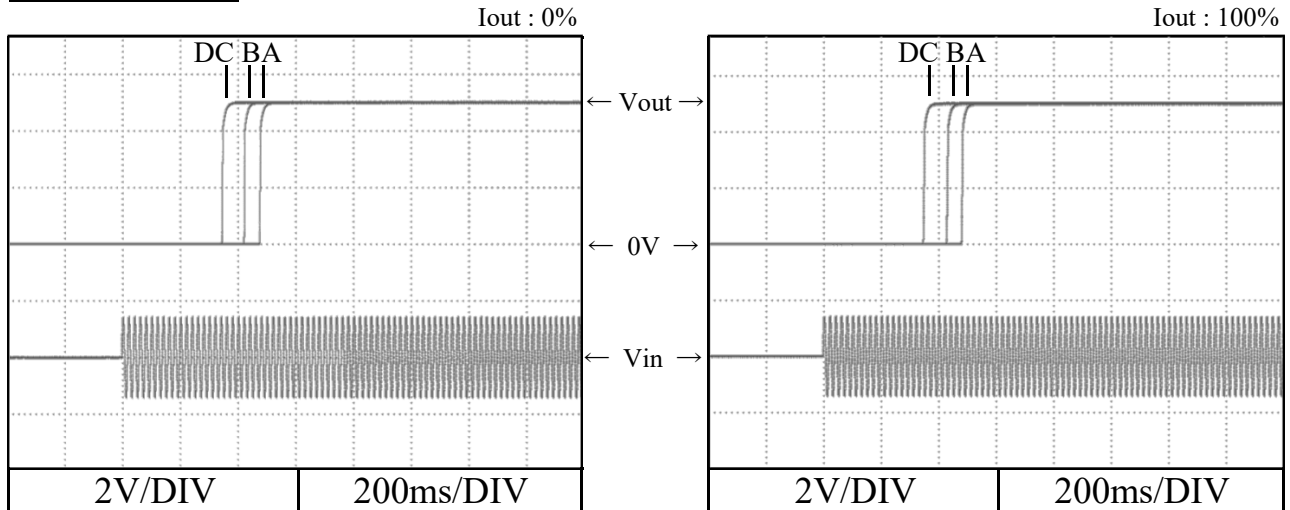

12V

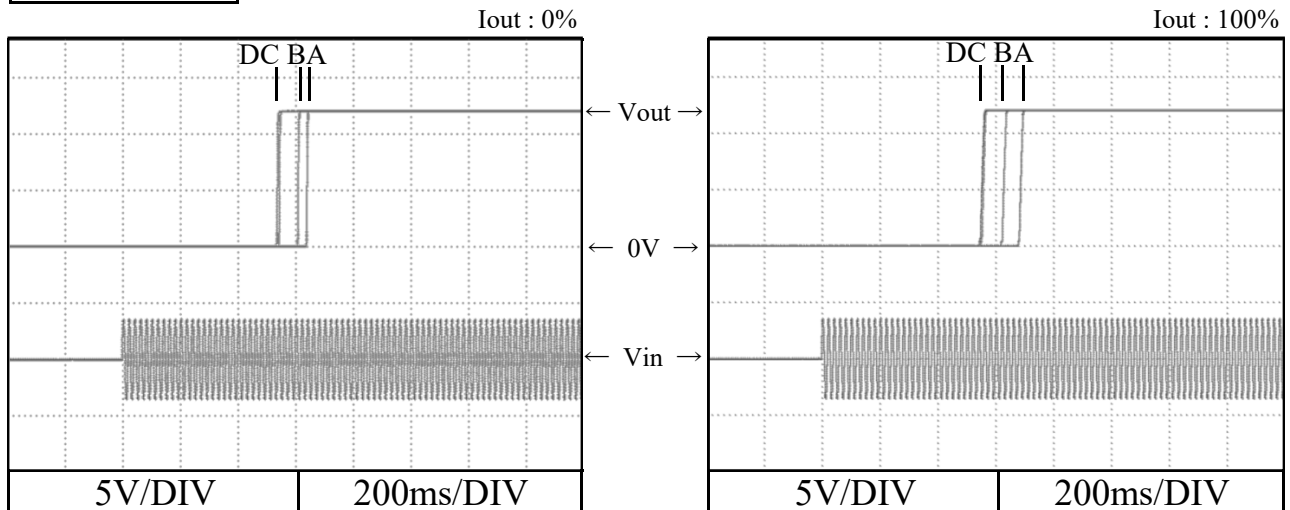

24V

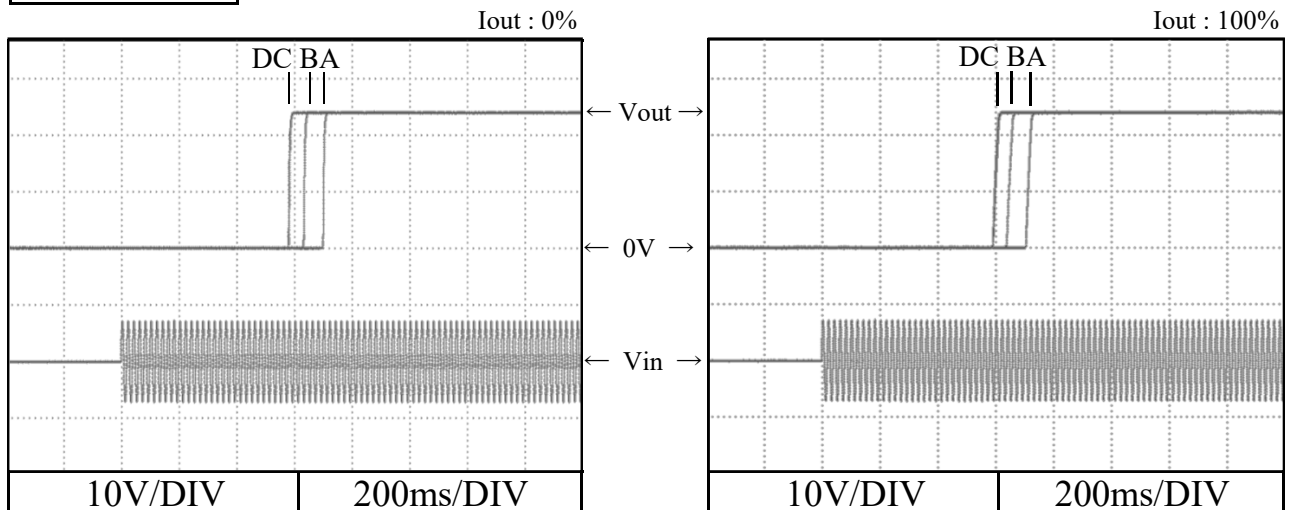

2.5 出力立ち下がり特性

Output fall characteristics

Conditions Vin : 85 VAC (A)
 100 VAC (B)
 200 VAC (C)
 265 VAC (D)
 Ta : 25 °C

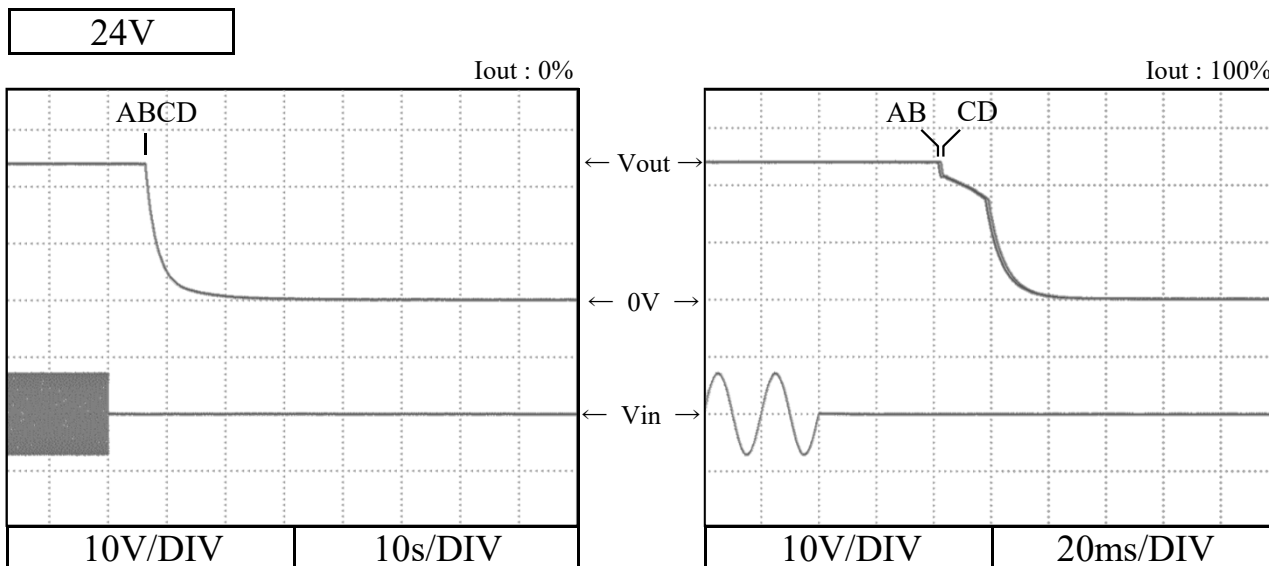
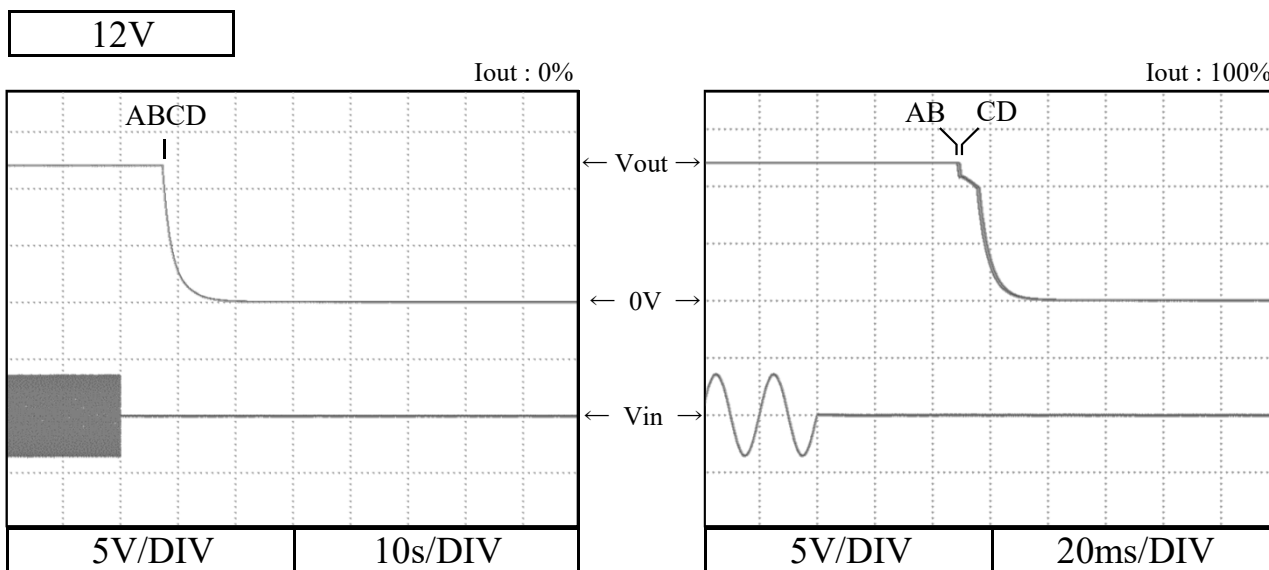
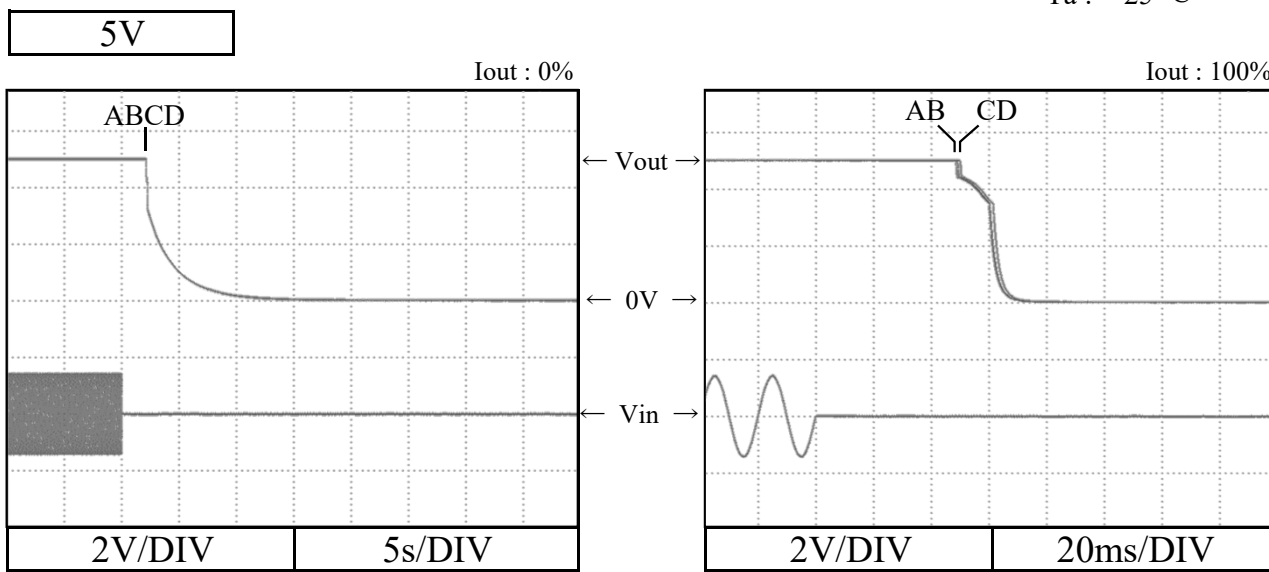

2.6 ON/OFFコントロール時出力立ち上がり、立ち下がり特性

Output rise, fall characteristics with ON/OFF Control

Conditions

V_{in} : 100 VAC

I_{out} : 100 %

T_a : 25 °C

標準品 HWS80A-*/R にて対応

For alternative standard model HWS80A-*/R

5V

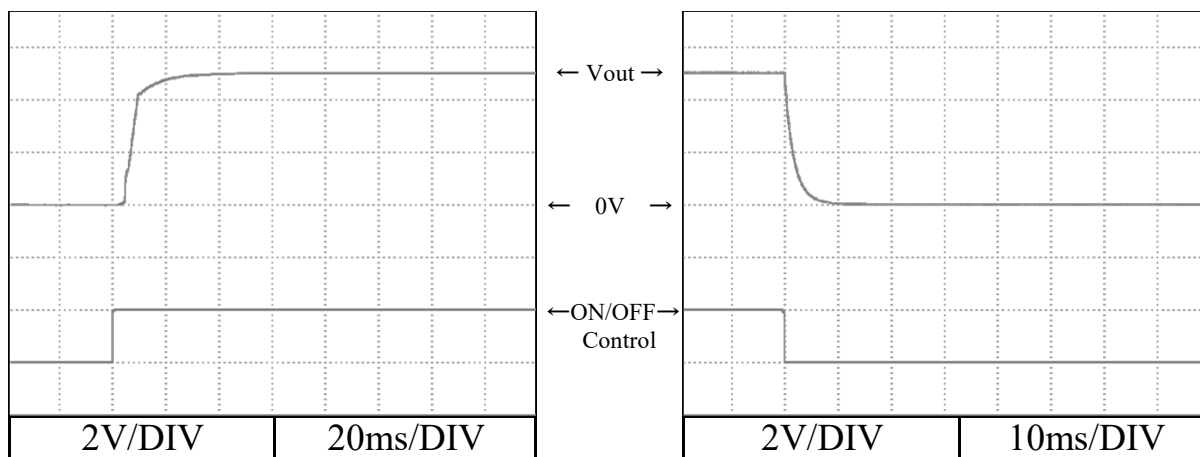

12V

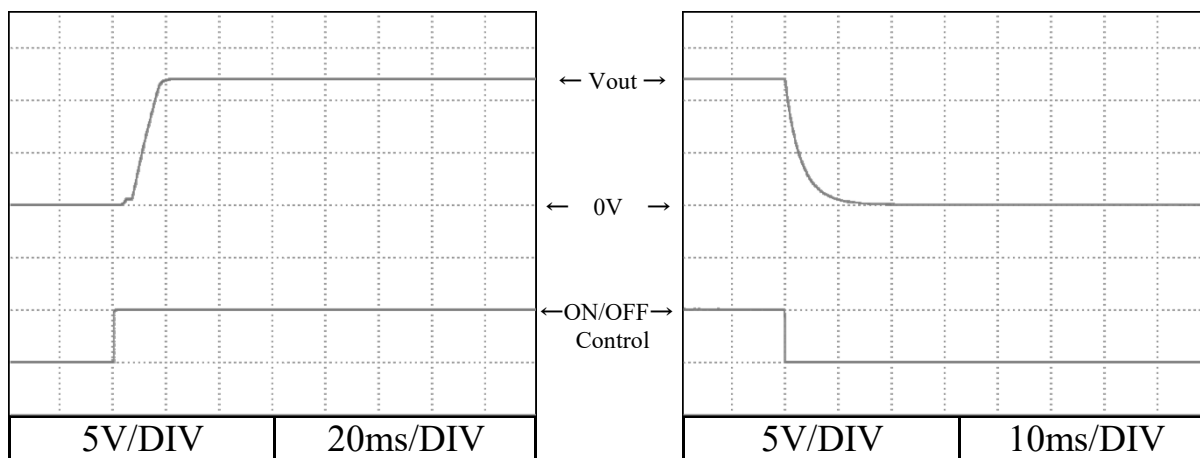

24V

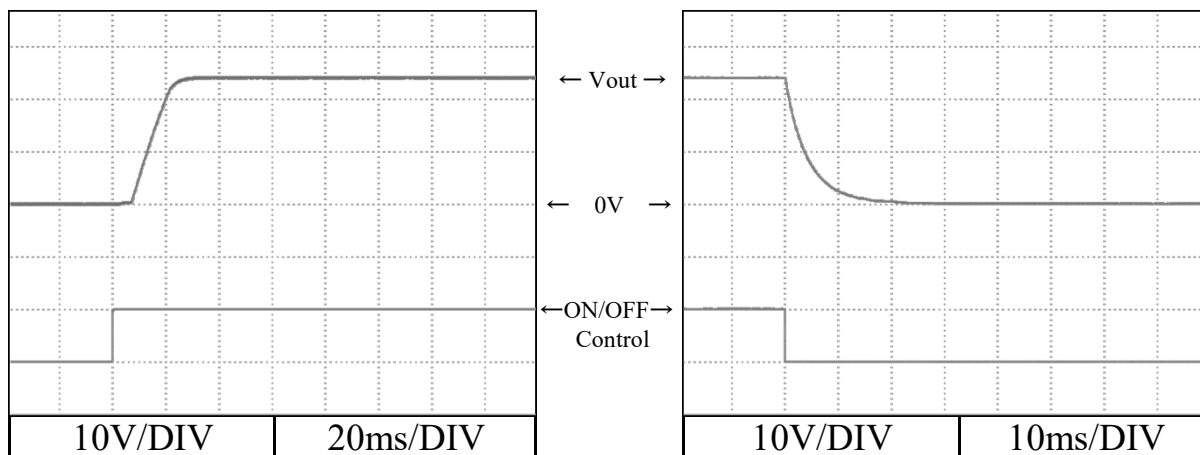

2.7 過電流保護特性

Over current protection (OCP) characteristics

Conditions V_{in} : 100 VAC
 T_a : -10 °C ---
 25 °C - - -
 50 °C ———

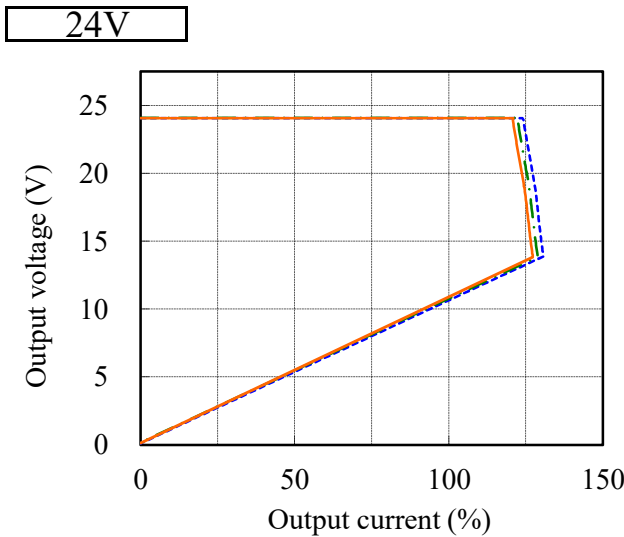
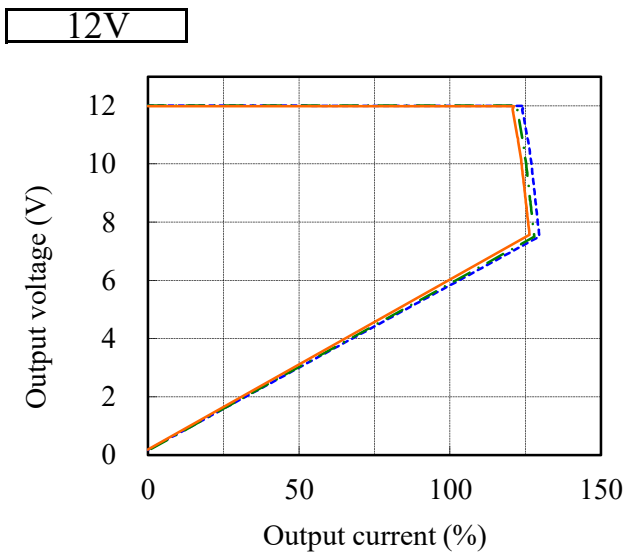
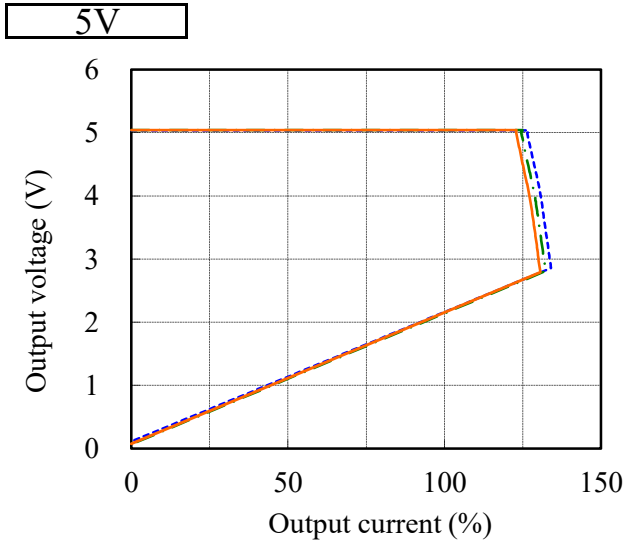

2.8 過電圧保護特性

Over voltage protection (OVP) characteristics

Conditions V_{in} : 100 VAC
 I_{out} : 0 %
 T_a : 25 °C

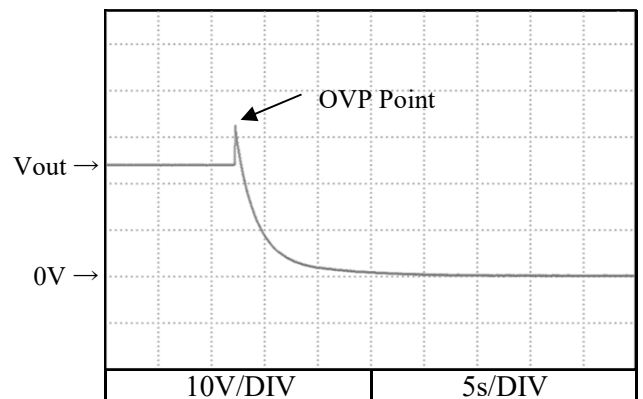
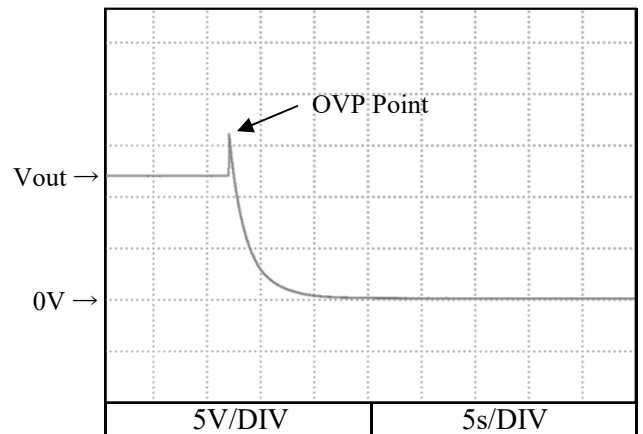
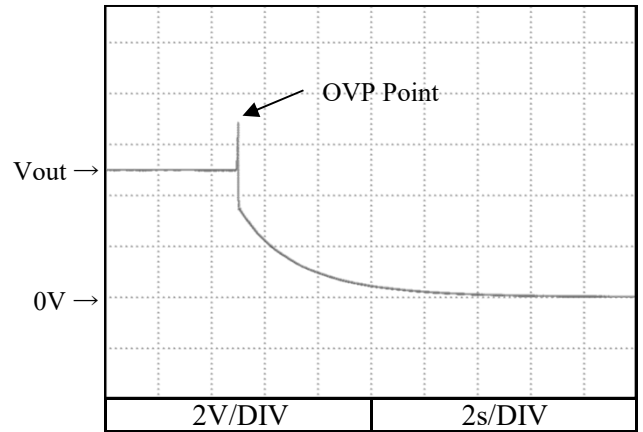

2.9 過渡応答 (入力急変) 特性

Dynamic line response characteristics

Conditions Vin : 85 VAC \longleftrightarrow 132VAC (A)
 170 VAC \longleftrightarrow 265VAC (B)
 Iout : 100 %
 Ta : 25 °C

5V

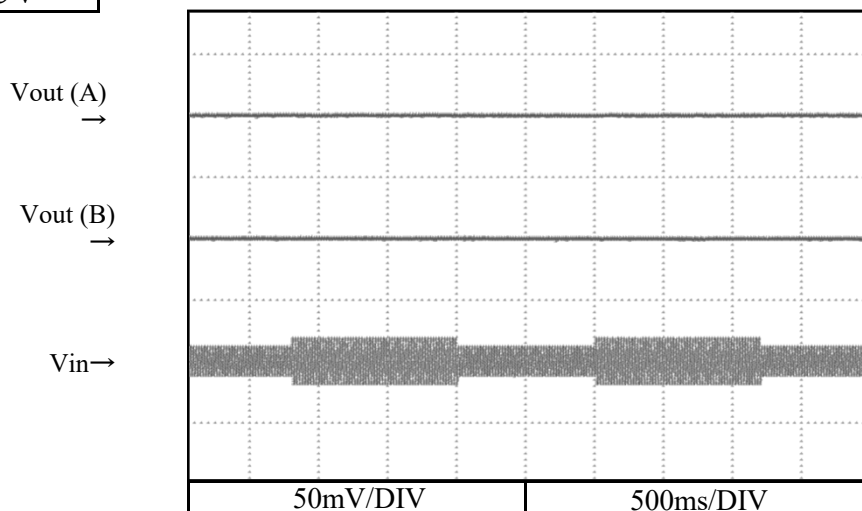

12V

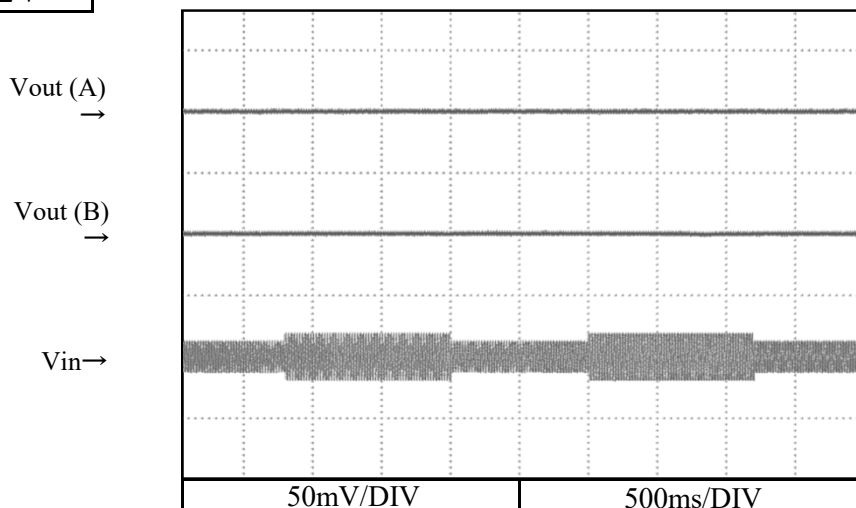

24V

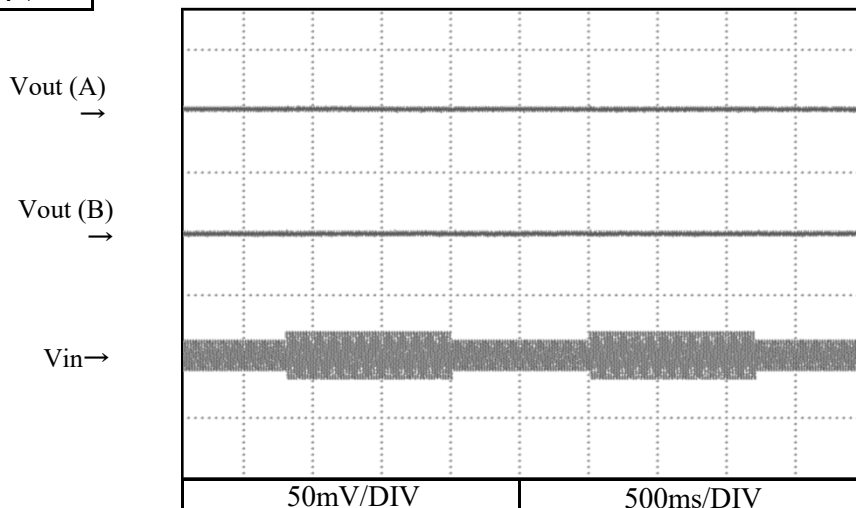

2.10 過渡応答（負荷急変）特性

Dynamic load response characteristics

Conditions Vin : 100 VAC
 Iout : 50 % ↔ 100 %
 (tr = tf = 50us)
 Ta : 25 °C

5V

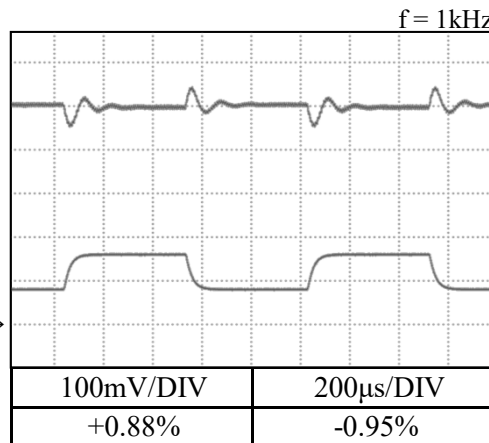
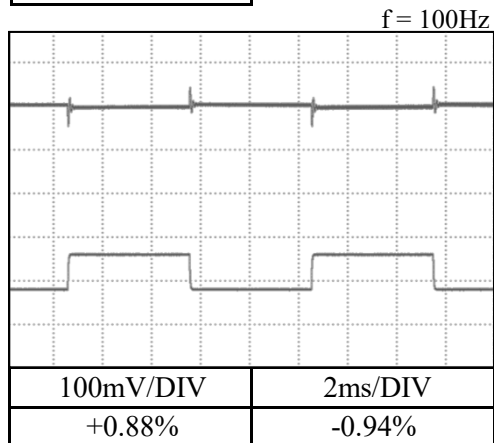

12V

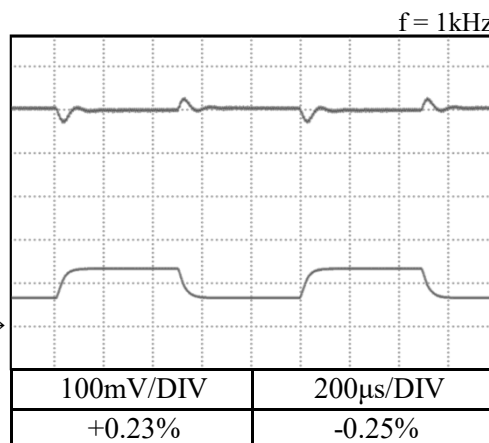
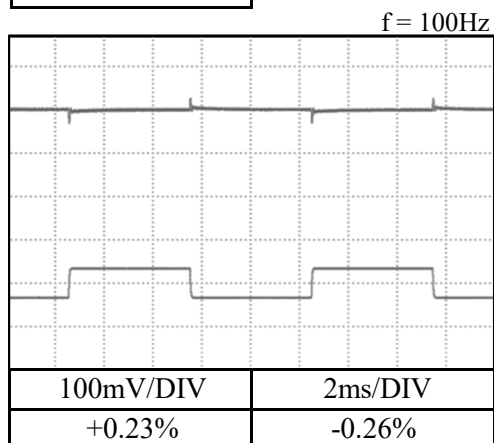

24V

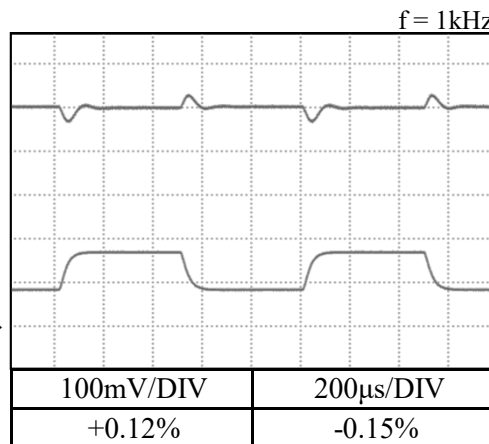
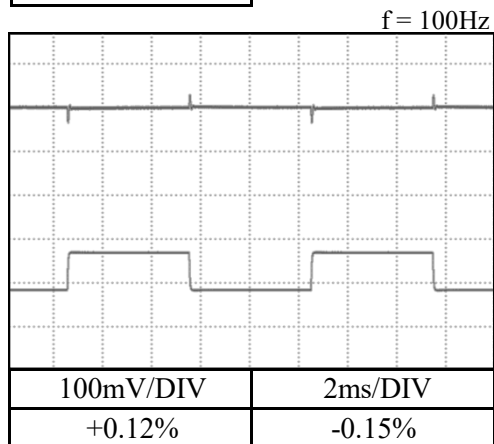

2.11 入力電圧瞬停特性

Response to brown out characteristics

Conditions Iout : 100 %
Ta : 25 °C

瞬停時間 Interruption time

A : 出力電圧が低下なし Output voltage does not drop.

B : 出力電圧の低下が0Vまでいかない Output voltage drop down not reaching 0V.

C : 出力電圧が0Vまで低下 Output voltage drops until 0V.

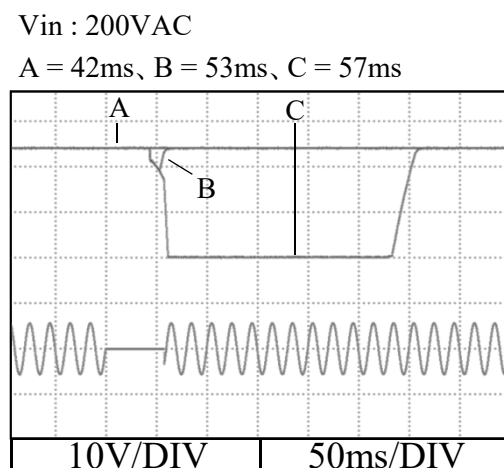
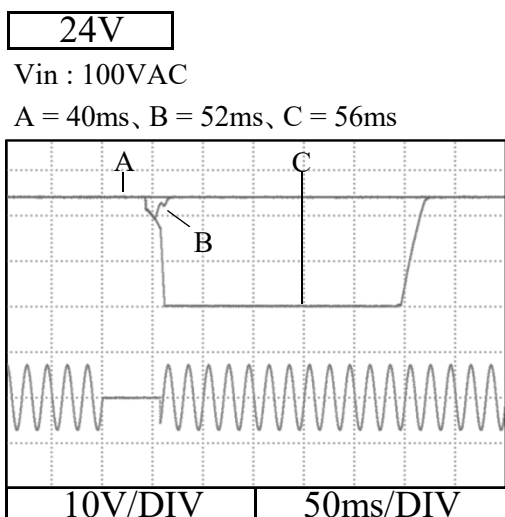
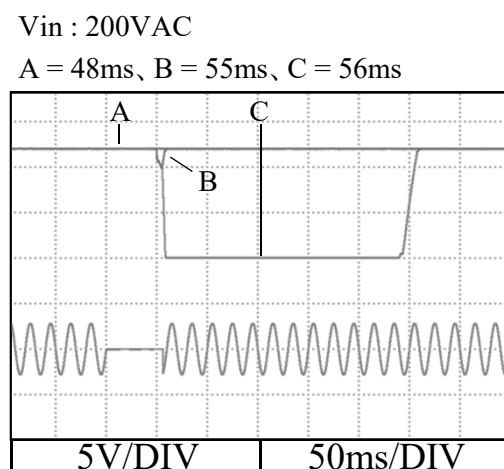
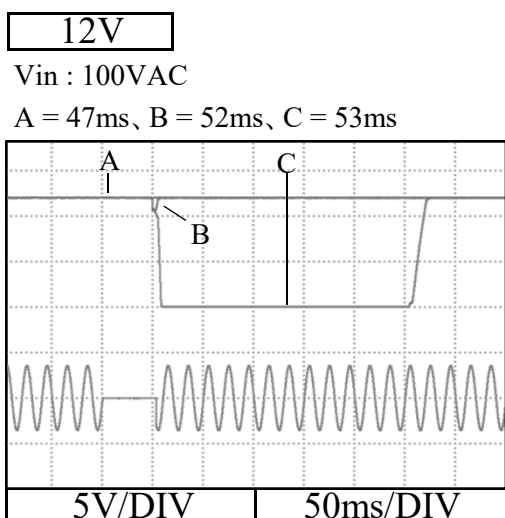
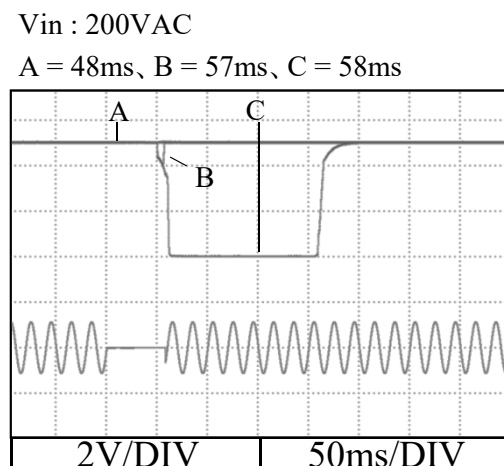
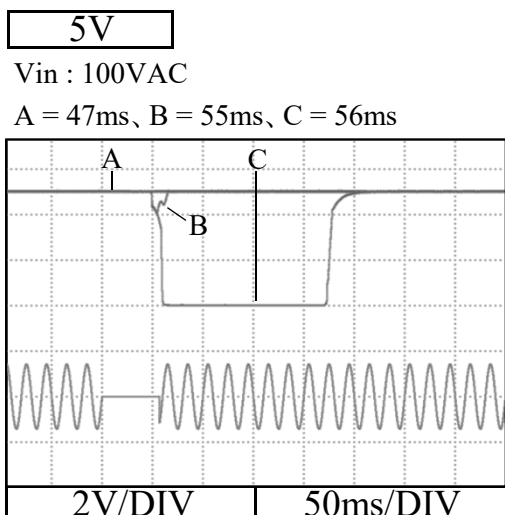

2.12 入力サージ電流（突入電流）波形
Inrush current waveform

5V

Conditions Vin : 100 VAC
Iout : 100 %
Ta : 25 °C

Switch on phase angle of input AC voltage
 $\phi = 0^\circ$

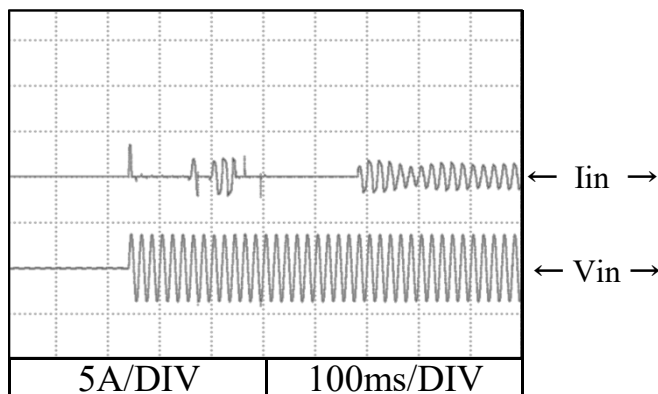

Switch on phase angle of input AC voltage
 $\phi = 90^\circ$

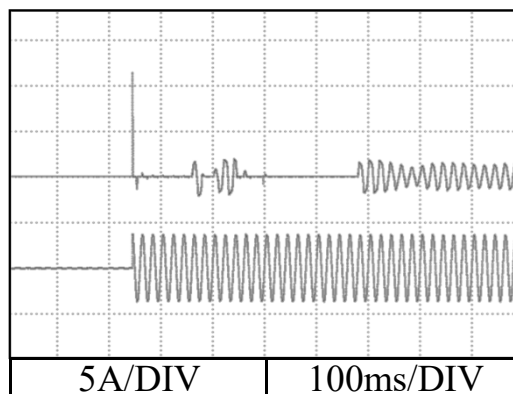

Conditions Vin : 200 VAC
Iout : 100 %
Ta : 25 °C

Switch on phase angle of input AC voltage
 $\phi = 0^\circ$

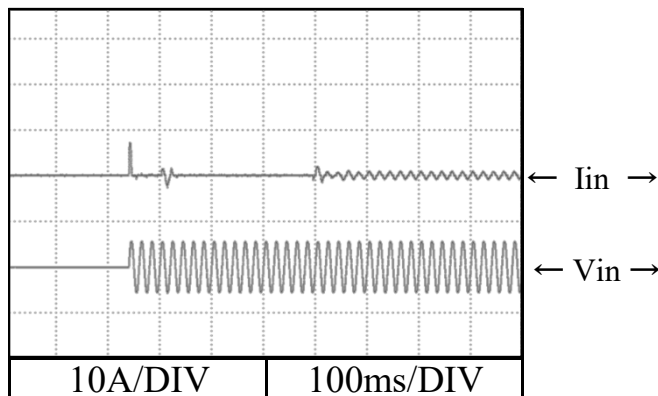

Switch on phase angle of input AC voltage
 $\phi = 90^\circ$

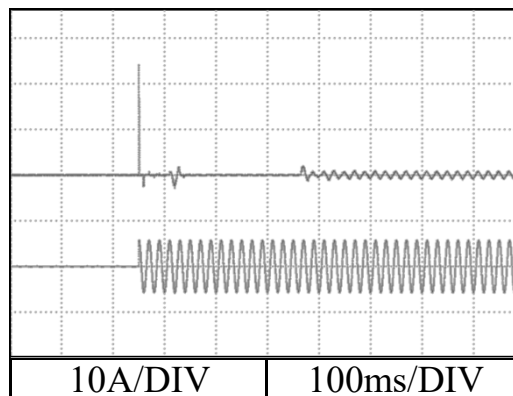

2.13 高調波成分

Input current harmonics

Conditions Iout : 100 %

Ta : 25 °C

5V

Vin : 100 VAC

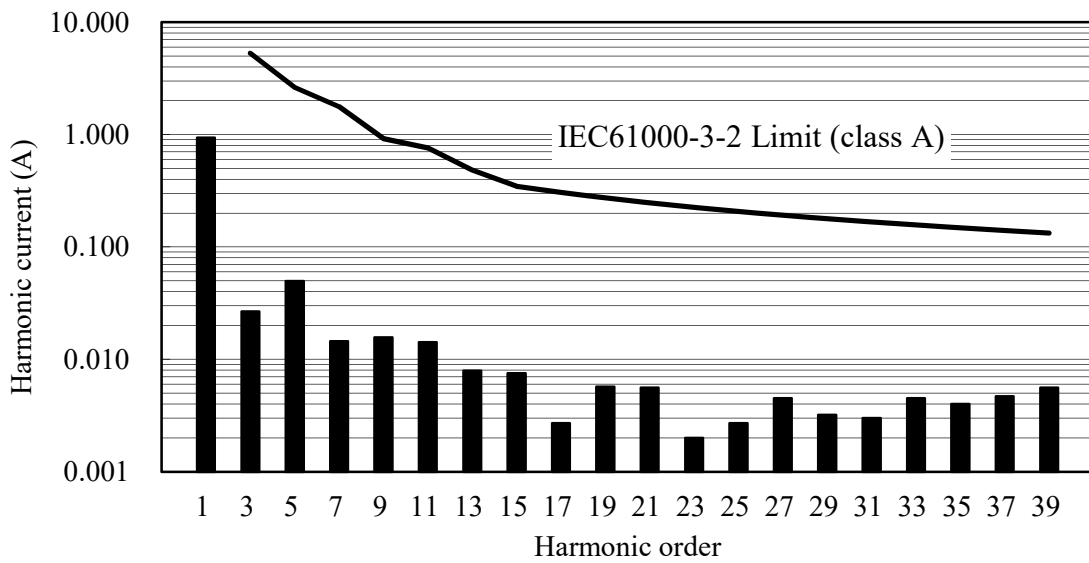

Vin : 230 VAC

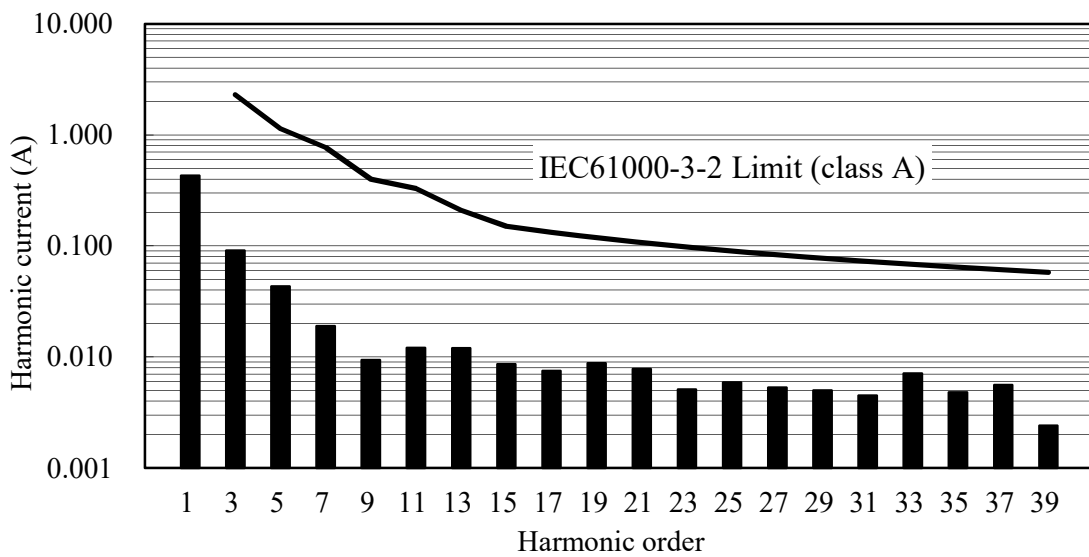

2.14 入力電流波形

Input current waveform

Conditions Iout : 100 %

Ta : 25 °C

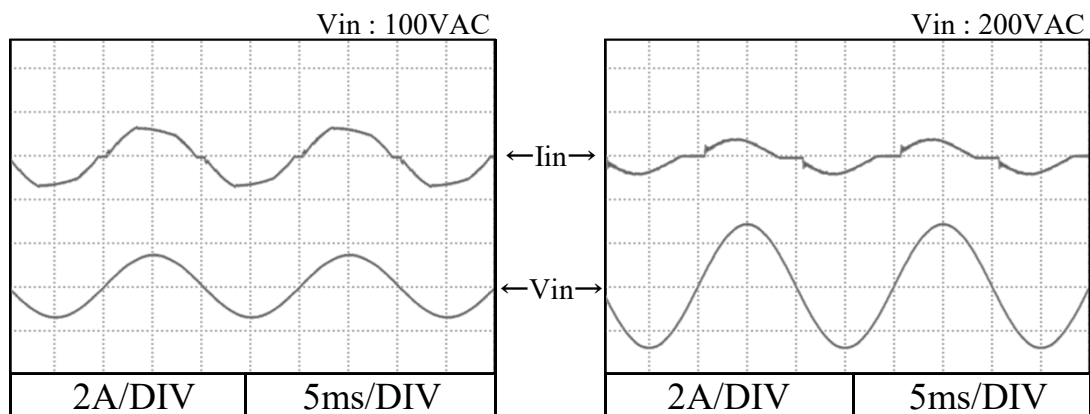

2.15 リーク電流特性

Leakage current characteristics

Conditions Iout : 0 % —
 100 % - - -
 Ta : 25 °C
Equipment used : 3156 (HIOKI)

5V

f: 50 Hz

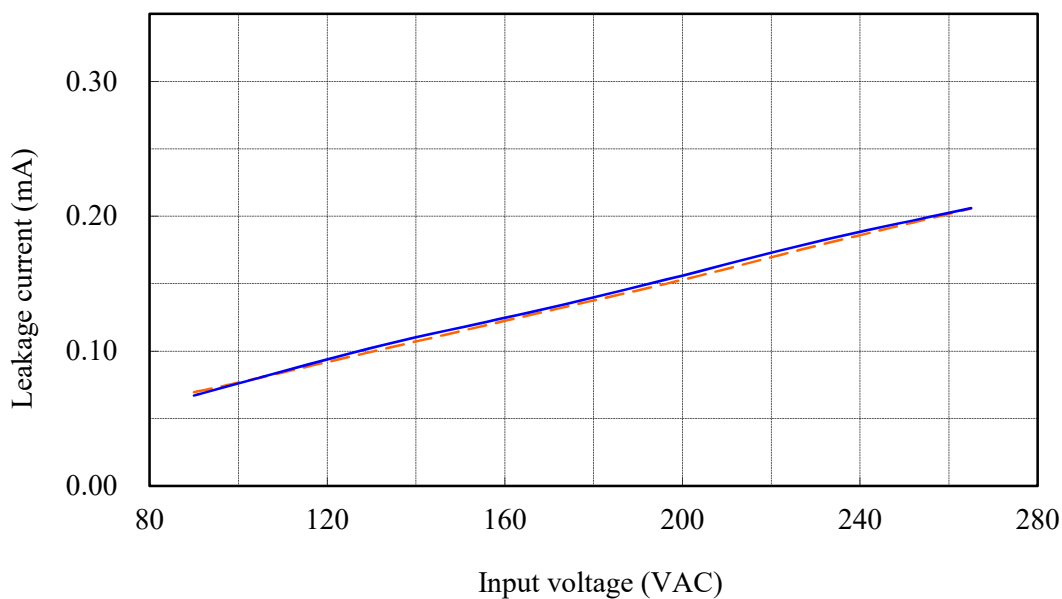

f: 60 Hz

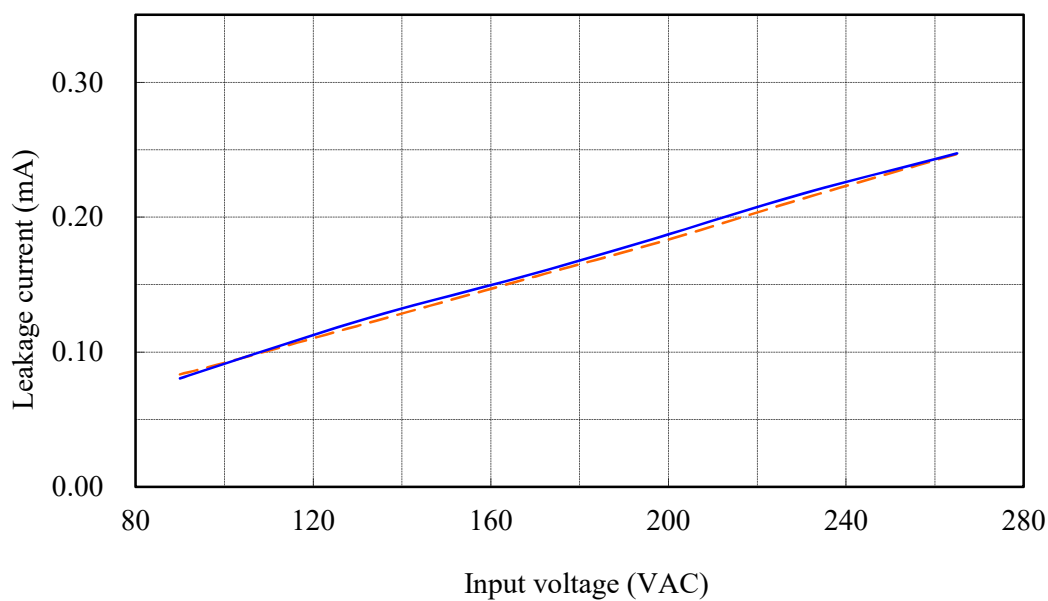

2.16 出力リップル、ノイズ波形 Output ripple and noise waveform

Conditions Vin : 100 VAC
Iout : 100 %
Ta : 25 °C

5V

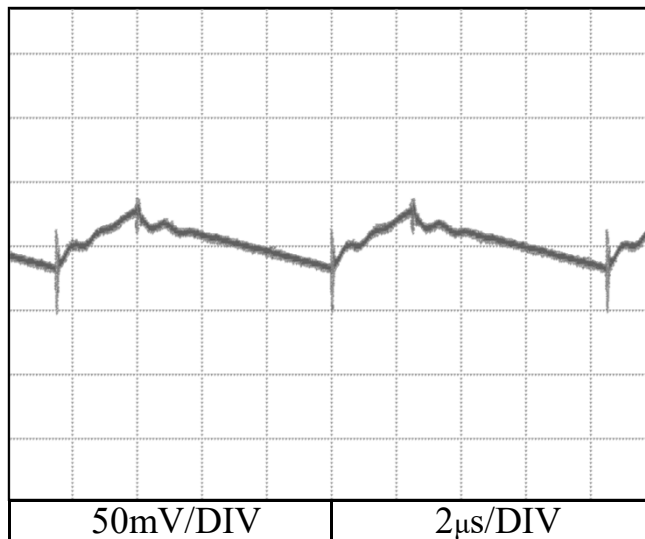

12V

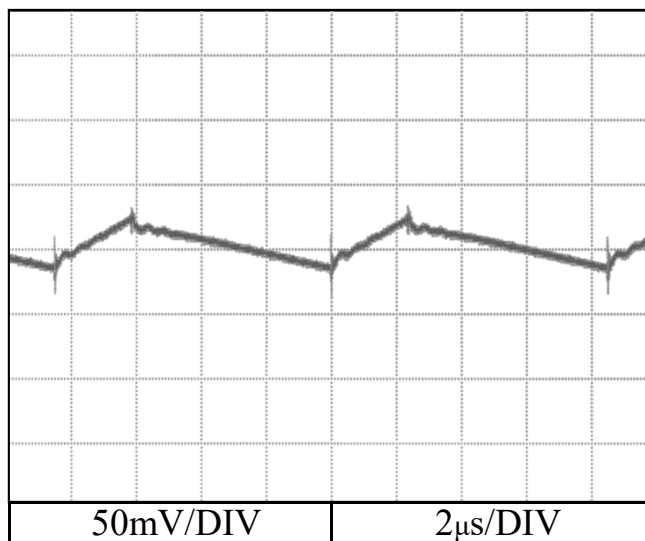

24V

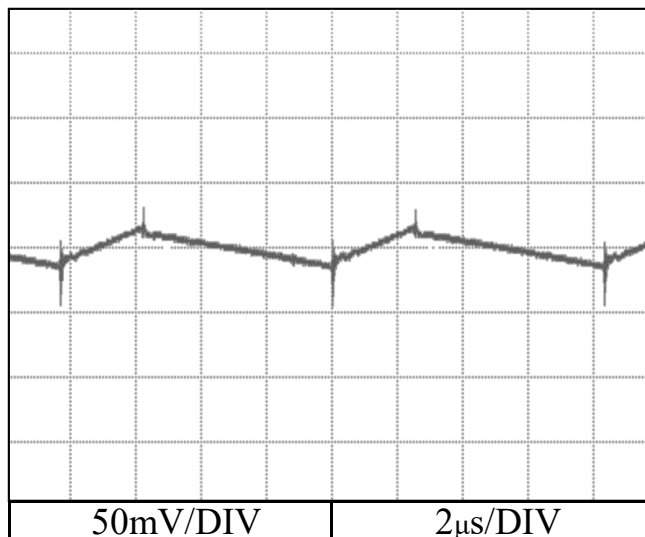

2.17 リモートコントロールOFF時入力電力・入力電流対入力電圧

Input power and Input current vs. Input voltage with Remote control OFF

標準品 HWS80A-*/R にて対応

For alternative standard model HWS80A-*/R

Condition Ta : 25 °C

5V

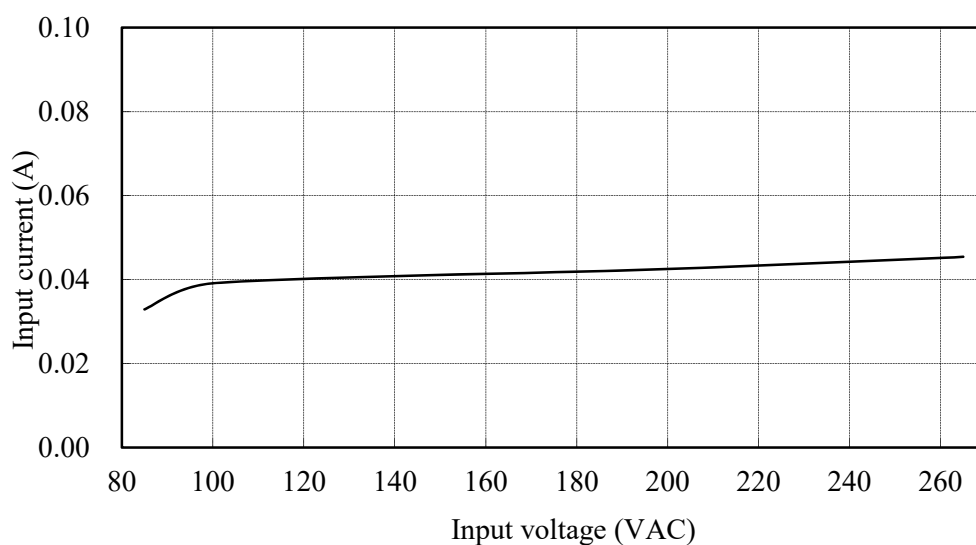
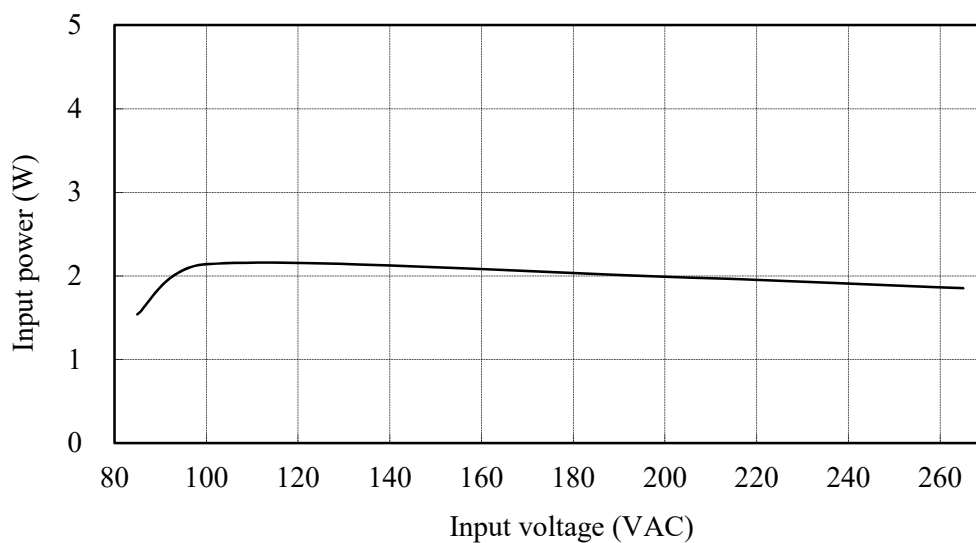

2.18 EMI 特性

Electro-Magnetic Interference characteristics

Conditions Vin : 230 VAC

Iout : 100 %

Ta : 25 °C

雑音端子電圧

Conducted Emission

5V

Point A (22MHz)		
Ref. Data	Limit (dB)	Measure (dB)
QP	60.0	44.1
AV	50.0	42.4

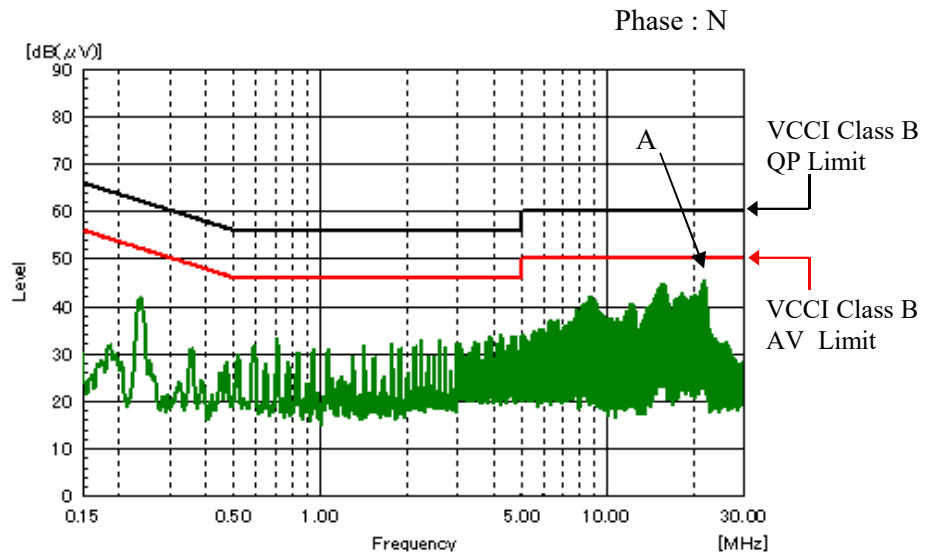

Point B (15MHz)		
Ref. Data	Limit (dB)	Measure (dB)
QP	60.0	41.7
AV	50.0	38.2

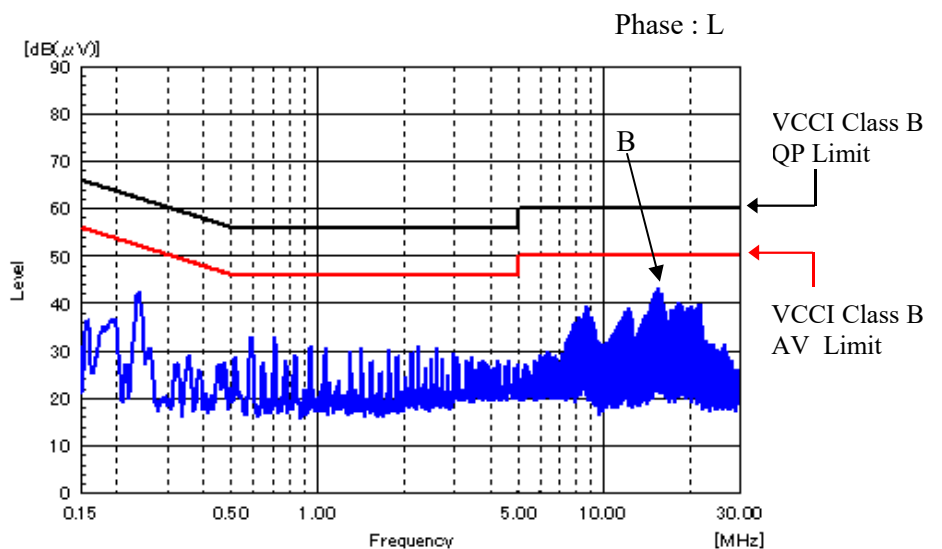

EN55011-B,EN55032-B,FCC-Bの限界値はVCCI class Bの限界値と同じ
Limit of EN55011-B,EN55032-B,FCC-B are same as its VCCI class B.

2.18 EMI 特性

Electro-Magnetic Interference characteristics

Conditions Vin : 230 VAC

Iout : 100 %

Ta : 25 °C

雑音端子電圧

Conducted Emission

12V

Point A (235kHz)		
Ref. Data	Limit (dB)	Measure (dB)
QP	62.3	42.9
AV	52.3	41.6

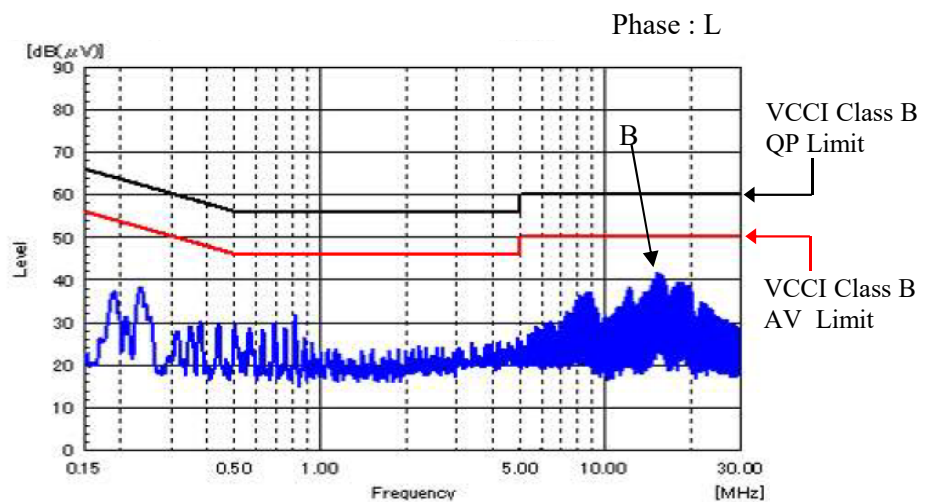
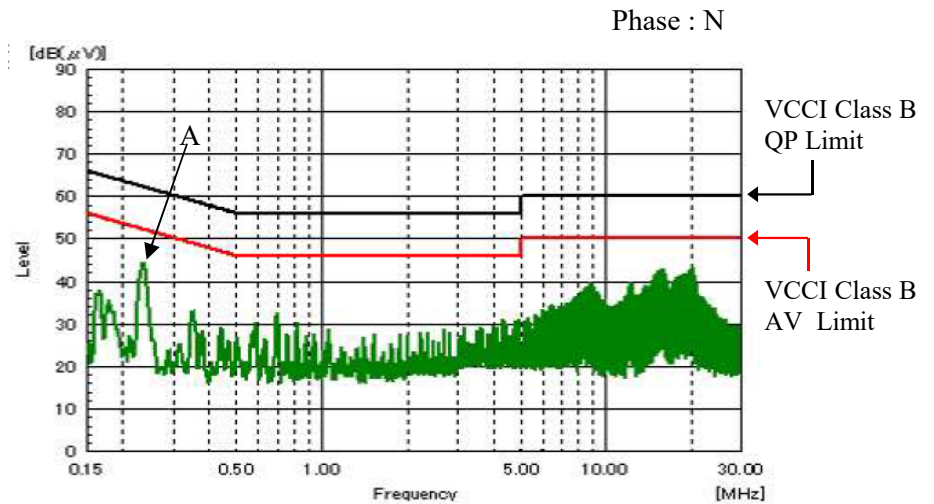

Point B (15MHz)		
Ref. Data	Limit (dB)	Measure (dB)
QP	60.0	39.5
AV	50.0	37.1

EN55011-B,EN55032-B,FCC-Bの限界値はVCCI class Bの限界値と同じ
Limit of EN55011-B,EN55032-B,FCC-B are same as its VCCI class B.

2.18 EMI 特性

Electro-Magnetic Interference characteristics

Conditions Vin : 230 VAC

Iout : 100 %

Ta : 25 °C

雑音端子電圧

Conducted Emission

24V

Point A (238kHz)		
Ref. Data	Limit (dB)	Measure (dB)
QP	62.2	43.0
AV	52.2	40.1

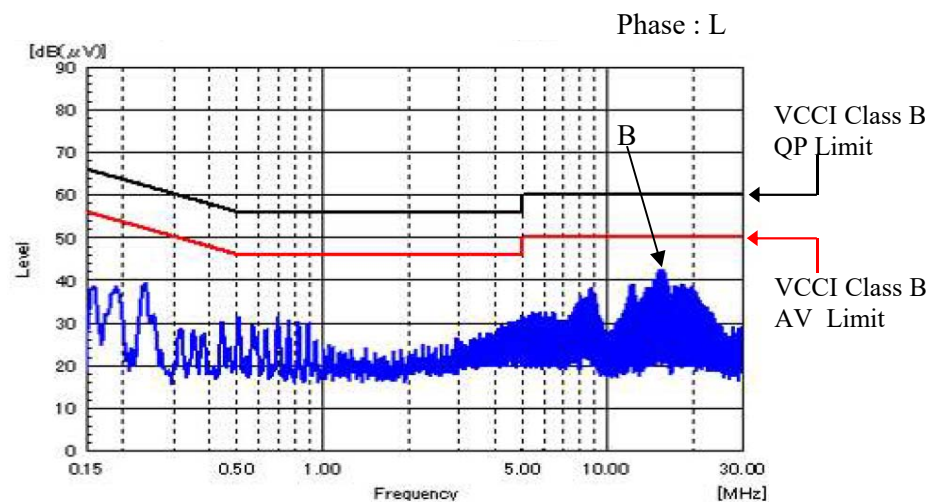
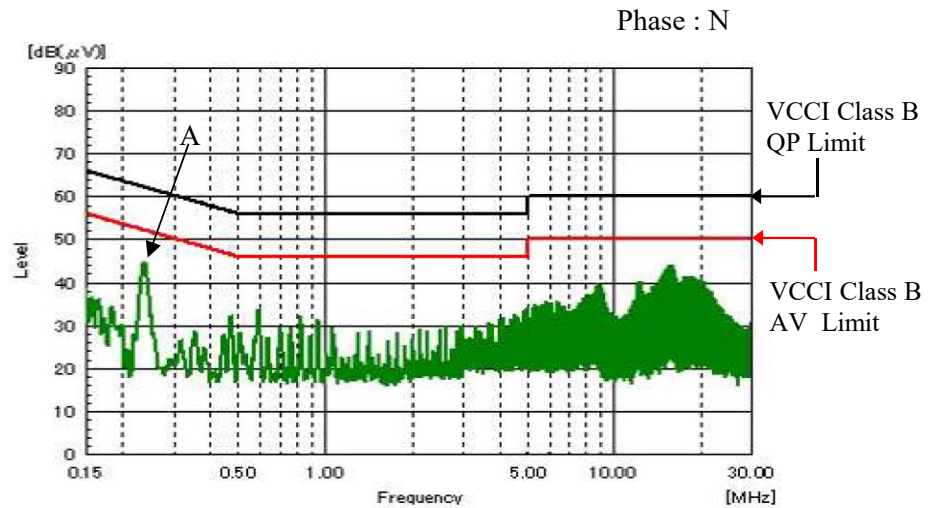

Point B (15MHz)		
Ref. Data	Limit (dB)	Measure (dB)
QP	60.0	41.5
AV	50.0	39.9

EN55011-B,EN55032-B,FCC-Bの限界値はVCCI class Bの限界値と同じ
Limit of EN55011-B,EN55032-B,FCC-B are same as its VCCI class B.

2.18 EMI 特性

Electro-Magnetic Interference characteristics

Conditions Vin : 230 VAC
Iout : 100 %
Ta : 25 °C

雑音電界強度

Radiated Emission

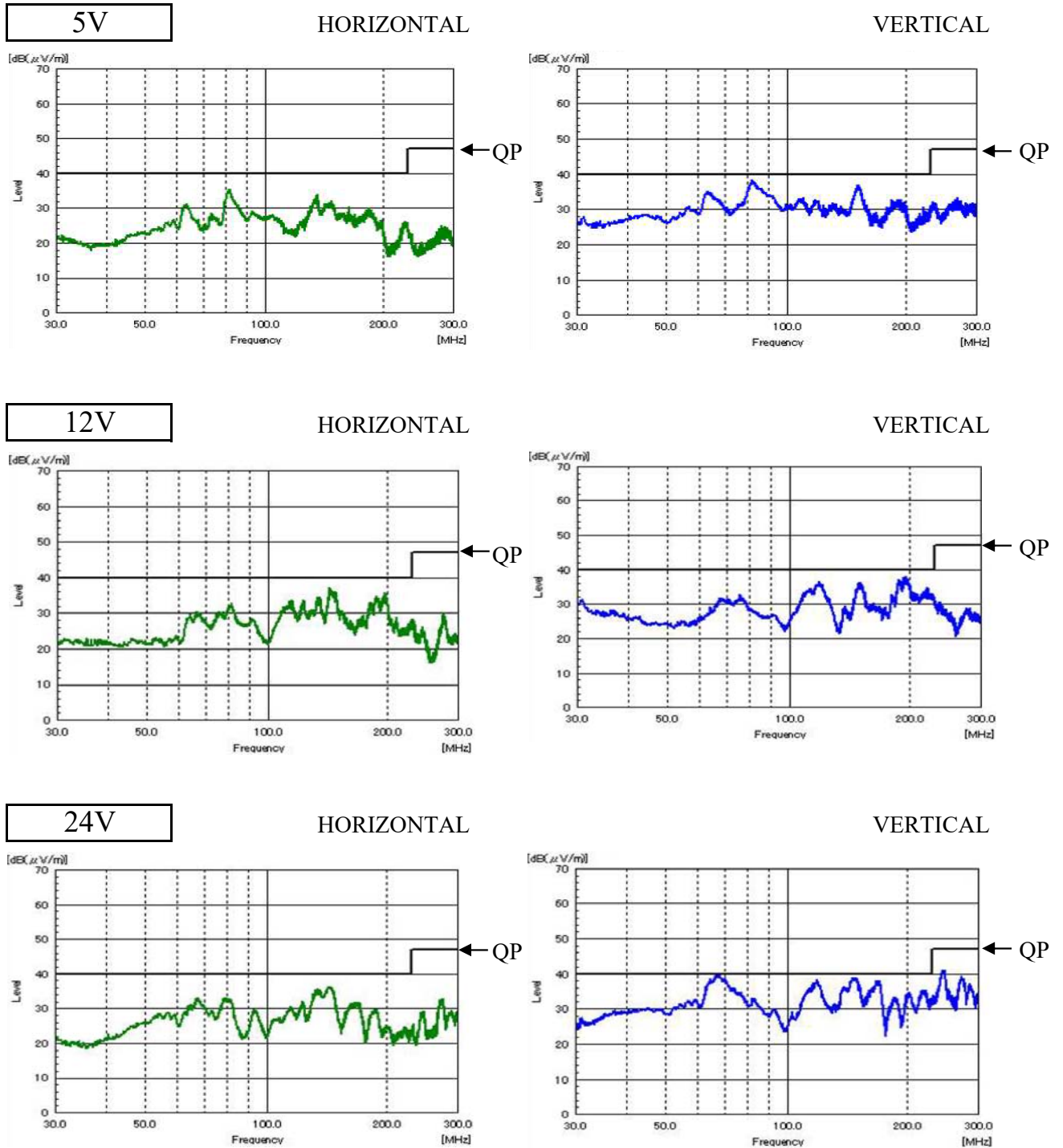

EN55011-B,EN55032-Bの限界値はVCCI class Bの限界値と同じ
Limit of EN55011-B,EN55032-B are same as its VCCI class B.

表示はピーク値
Indication is peak values.