

JWS150

EVALUATION DATA

型式データ

DWG No. A160-53-01			
承認	承認	査閲	担当
<i>Murayama</i> 29. MAY. '97	<i>Therle</i> 28. MAY. '97	<i>M. Kizumi</i> 28. MAY. '97	<i>H. Tanaka</i> 28. May. '97

INDEX

1. 測定方法	Evaluation Method	PAGE
1.1	測定回路 Circuit used for determination	T-1~5
	(1) 静特性 Steady state data	
	(2) 通電ドリフト特性 Warm up voltage drift characteristics	
	(3) 過電流保護特性 Over current protection (OCP) characteristics	
	(4) 過電圧保護特性 Over voltage protection (OVP) characteristics	
	(5) 出力立ち上がり特性 Output rise characteristics	
	(6) 出力立ち下がり特性 Output fall characteristics	
	(7) 過渡応答 (入力急変) 特性 Dynamic line response characteristics	
	(8) 過渡応答 (負荷急変) 特性 Dynamic load response characteristics	
	(9) 入力サージ電流 (突入電流) 特性 Inrush current characteristics	
	(10) リーク電流特性 Leakage current characteristics	
	(11) 出力リップル、ノイズ波形 Output ripple and noise waveform	
1.2	使用測定機器 List of equipment used	T-6
2.	特性データ Characteristics	
2.1	静特性 Steady state data	
	(1) 入力・負荷・温度変動	
	Regulation - line and load, temperature drift	T-7
	(2) 出力電圧・リップル電圧対入力電圧	
	Output voltage and ripple voltage vs. input voltage	T-8
	(3) 効率・入力電流対出力電流	
	Efficiency and input current vs. output current	T-9
	(4) 力率・入力電流対出力電流	
	Power factor and input current vs. output current	T-10
2.2	通電ドリフト特性 Warm up voltage drift characteristics	T-11
2.3	過電流保護特性 Over current protection (OCP) characteristics	T-12
2.4	過電圧保護特性 Over voltage protection (OVP) characteristics	T-13
2.5	出力立ち上がり特性 Output rise characteristics	T-14~17
2.6	出力立ち下がり特性 Output fall characteristics	T-18~21
2.7	ON/OFFコントロール時出力立ち上がり特性	
	Output rise characteristics with ON/OFF CONTROL	T-22
	準標準品 JWS150-*/R にて対応	
	For alternative standard model JWS150-*/R	
2.8	ON/OFFコントロール時出力立ち下がり特性	
	Output fall characteristics with ON/OFF CONTROL	T-23
	準標準品 JWS150-*/R にて対応	
	For alternative standard model JWS150-*/R	

2.9	出力保持時間特性	Hold up time characteristics	T-24
2.10	過渡応答（入力急変）特性	Dynamic line response characteristics	T-25～26
2.11	過渡応答（負荷急変）特性	Dynamic load response characteristics	T-27～38
2.12	入力電圧瞬停特性	Response to brown out characteristics	T-39～40
2.13	入力サージ電流（突入電流）特性	Inrush current waveform	T-41～42
2.14	瞬停時突入電流特性	Inrush current characteristics	T-43～44
2.15	入力電流波形	Input current waveform	T-45
2.16	高調波成分	Input current harmonics	T-46
2.17	リーク電流特性	Leakage current characteristics	T-47～48
2.18	出力リップル、ノイズ波形	Output ripple and noise waveform	T-49～56
2.19	EMI特性	Electro-Magnetic Interference characteristics	T-57～66

使用記号 Terminology used

	Definition	
Vin 入力電圧	Input voltage
Vout 出力電圧	Output voltage
Iin 入力電流	Input current
Iout 出力電流	Output current
Ta 周囲温度	Ambient temperature

1. 1

測定回路

Circuit used for determination

(1) 静特性

Steady state data

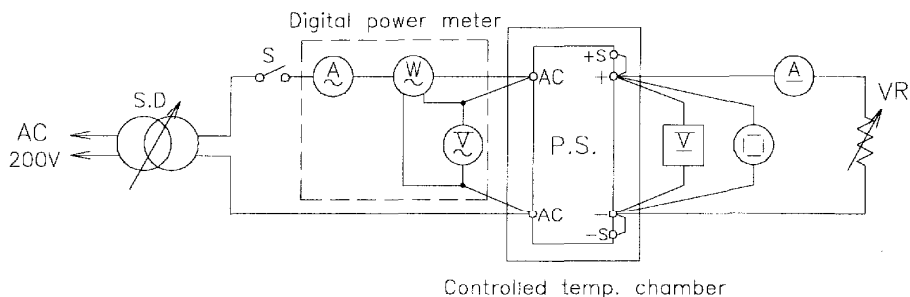

(2) 通電ドリフト特性

Warm up voltage drift characteristics

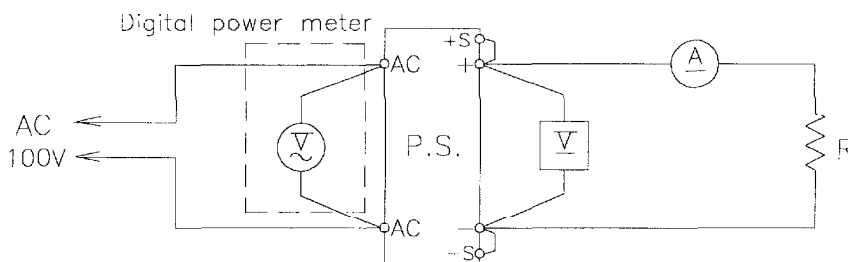

(3) 過電流保護特性

Over current protection (O.C.P.) characteristics

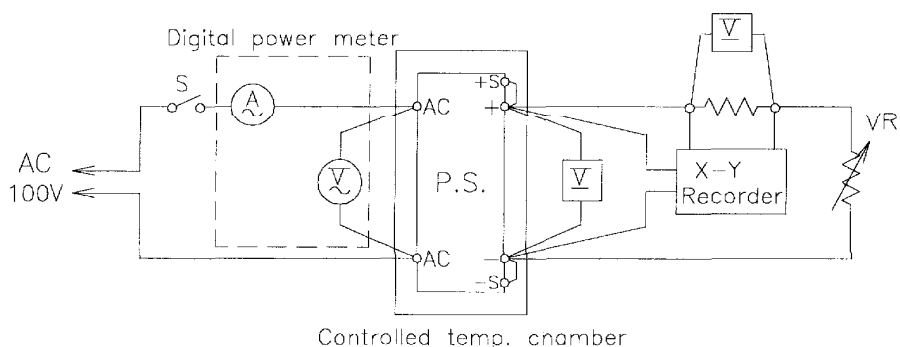

(4) 過電圧保護特性

Over voltage protection (O.V.P.) characteristics

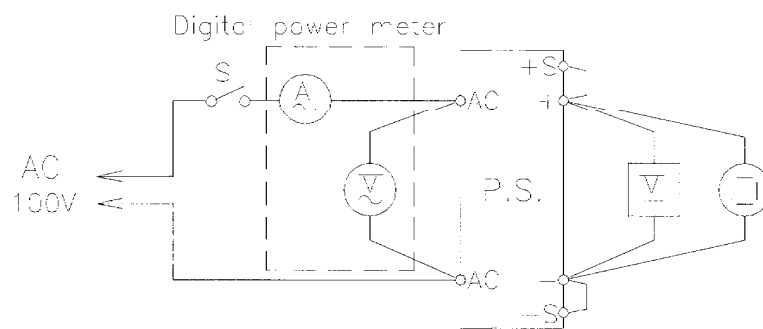

(5) 出力立ち上がり特性

Output rise characteristics

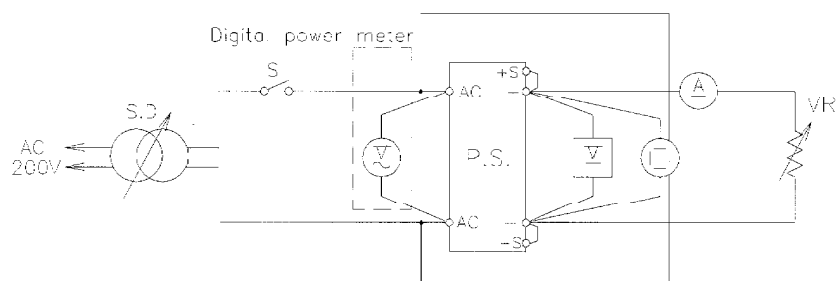

(6) 出力立ち下がり特性

Output fall characteristics

Same as output rise characteristics

(7) 出力立ち上がり特性 (ON/OFFコントロール時)

Output rise characteristics with ON/OFF CONTROL

標準品 JWS150-*/R にて対応 For alternative standard model JWS150-*/R

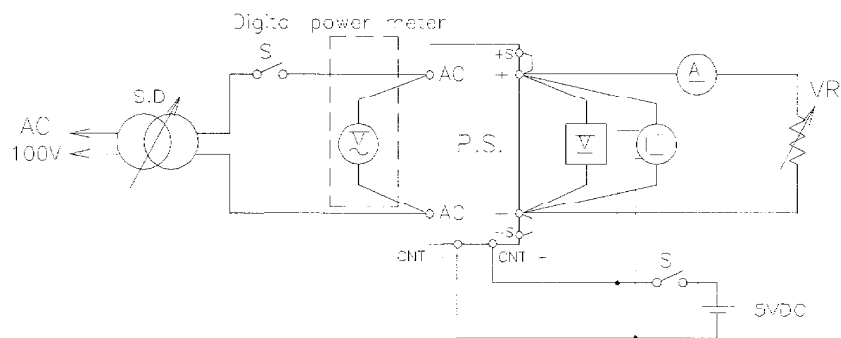

(8) 出力立ち下がり特性 (ON/OFFコントロール時)

Output fall characteristics with ON/OFF CONTROL

準標準品 JWS150-*/R にて対応 For alternative standard model JWS150-*/R

Same as output rise characteristics with ON/OFF CONTROL

(9) 過渡応答 (入力急変) 特性

Dynamic line response characteristics

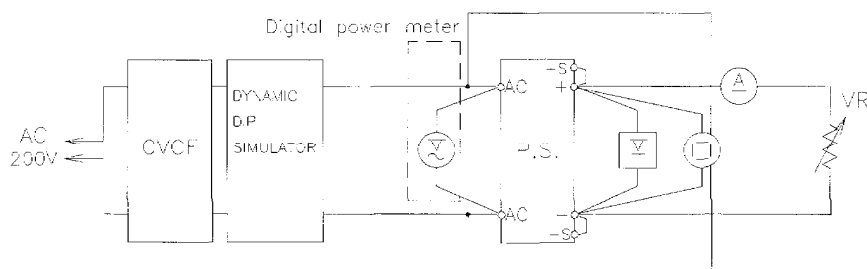

(10) 過渡応答 (負荷急変) 特性

Dynamic road response characteristics

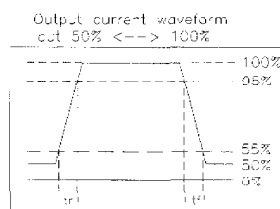
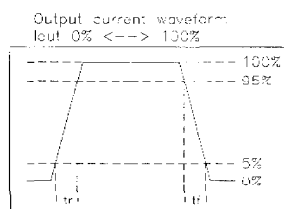
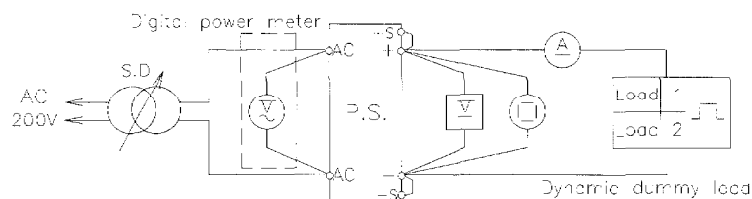

(11) 入力サージ電流 (突入電流) 特性

Inrush current characteristics

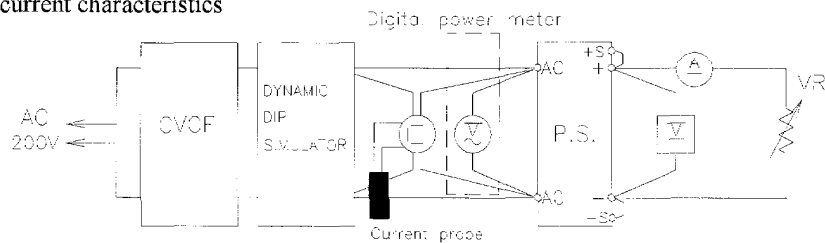

(12) リーク電流

Leakage current characteristics

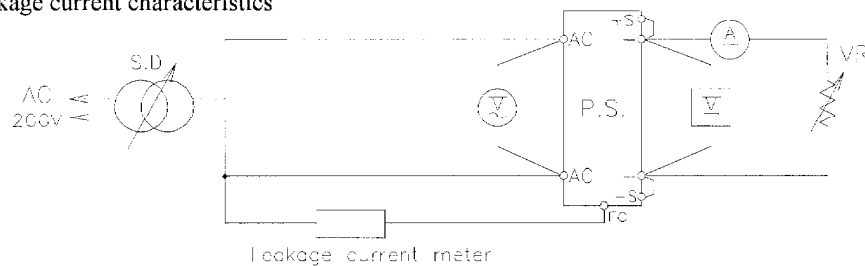

NOTE : For YOKOGAWA TYPE 3226
 Leakage current measured through a 1k Ω resistor.
 Range used ---AC+DC

(13) 出力リップルノイズ

Output ripple noise

(a) Normal Mode

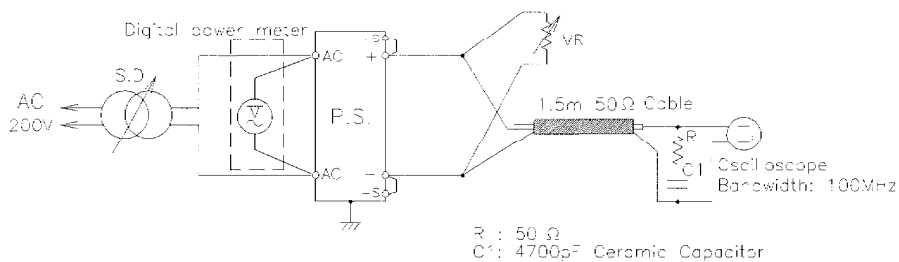

(b) Normal + Common Mode

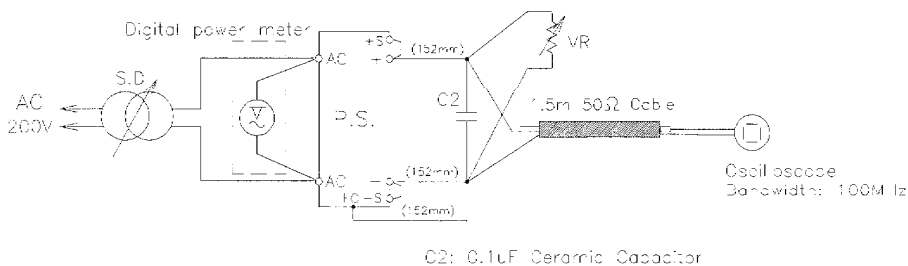

(14) EMI 特性

Electro-Magnetic Interference characteristics

(a) 雑音端子電圧 (帰還ノイズ)

Conducted Emission Noise

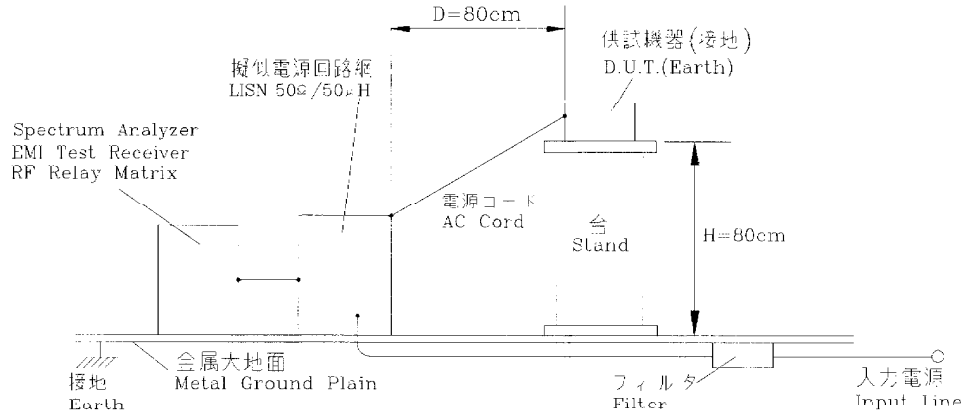

(b) 雑音電界強度 (輻射ノイズ)

Radiated Emission Noise

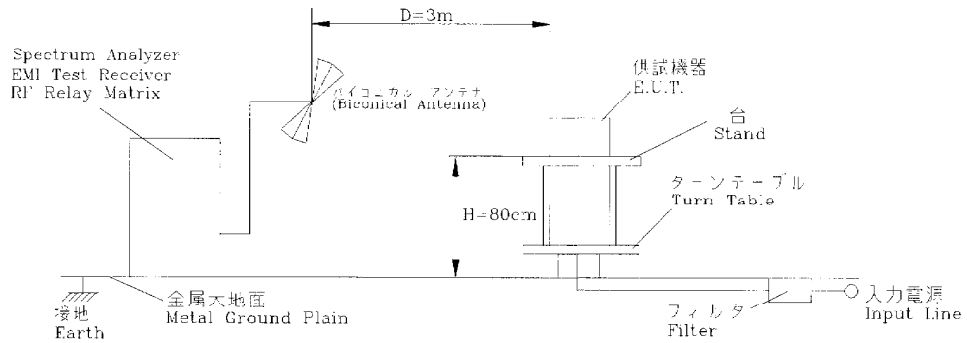

1.2 使用測定機器 LIST OF EQUIPMENT USED

	EQUIPMENT USED	MANUFACTURER	MODEL NO.
1	OSCILLOSCOPE	HITACHI DENSHI	V-1050F
2	DIGITAL STORAGE OSCILLOSCOPE	TEKTRONIX	TDS540B
3	DIGITAL MULTIMETER	ADVANTEST	R6341A
4	DIGITAL POWER METER	YOKOGAWA ELECT.	WT110
5	DC AMPERE METER	YOKOGAWA ELECT.	TYPE2051
6	CURRENT PROBE/AMPLIFIER	TEKTRONIX	A6303/AM503
7	DYNAMIC DUMMY LOAD	TAKAMIZAWA	PSA150D
8	SLIDE REGURATOR	MATSUNAGA	S3-3019
9	CVCF	KIKUSUI	PCR6000
10	LEAKAGE CURRENT METER	SIMPSON	229-2
11	LEAKAGE CURRENT METER	YOKOGAWA	TYPE3226
12	X-Y RECORDER	GRAPHTEC	WX4309
13	DYNAMIC DIP SIMULATOR	TAKAMIZAWA CYBERNETICS	PSA-300
14	CONTROLLED TEMP. CHANBER	TABAI ESPEC	SH-240
15	SPECTRUM ANALYZER	ROHDE & SCHWARZ	FSA
16	EMI TEST RECEIVER	ROHDE & SCHWARZ	ESHS10
17	EMI TEST RECEIVER	ROHDE & SCHWARZ	ESVS10
18	RF RELAY MATRIX	ROHDE & SCHWARZ	PSU
19	LISN	KYORITU DENSHI	KNW-242
20	ANTENA(BICONICAL ANTENA)	SCHWARZBECK	BBA9106

2. 特性データ Characteristics

2.1 静特性 Steady state data

(1) 入力、負荷、温度変動 Regulation - line and load, temperature drift

5V

1. Regulation - line and load

condition Ta : 25°C

Iout \ Vin	85VAC	100VAC	200VAC	265VAC	line regulation	
0%	5.023V	5.023V	5.023V	5.023V	0mV	0.00%
50%	5.022V	5.023V	5.022V	5.022V	1mV	0.02%
100%	5.022V	5.022V	5.022V	5.022V	0mV	0.00%
load	1mV	1mV	1mV	1mV		
regulation	0.02%	0.02%	0.02%	0.02%		

2. Temperature drift

conditions Vin=100VAC
Io =100%

Ta	-10°C	+25°C	+50°C	temperature stability	
Vo	5.022V	5.022V	5.018V	4mV	0.08%

12V

1. Regulation - line and load

condition Ta : 25°C

Iout \ Vin	85VAC	100VAC	200VAC	265VAC	line regulation	
0%	11.990V	11.990V	11.990V	11.990V	0mV	0.00%
50%	12.003V	12.003V	12.003V	12.003V	0mV	0.00%
100%	12.018V	12.018V	12.018V	12.018V	0mV	0.00%
load	28mV	28mV	28mV	28mV		
regulation	0.12%	0.12%	0.12%	0.12%		

2. Temperature drift

conditions Vin=100VAC
Io =100%

Ta	-10°C	+25°C	+50°C	temperature stability	
Vo	12.030V	12.018V	11.991V	39mV	0.16%

24V

1. Regulation - line and load

condition Ta : 25°C

Iout \ Vin	85VAC	100VAC	200VAC	265VAC	line regulation	
0%	24.016V	24.016V	24.016V	24.016V	0mV	0.000%
50%	24.019V	24.019V	24.019V	24.019V	0mV	0.000%
100%	24.027V	24.026V	24.027V	24.027V	1mV	0.004%
load	11mV	10mV	11mV	11mV		
regulation	0.05%	0.04%	0.05%	0.05%		

2. Temperature drift

conditions Vin=100VAC
Io =100%

Ta	-10°C	+25°C	+50°C	temperature stability	
Vo	24.045V	24.026V	24.022V	23mV	0.10%

2.1 (2) 出力電圧、リップル電圧対入力電圧

Conditions Iout : 100%

Output voltage and Ripple voltage v.s. Input voltage

Ta : -10°C
 : 25°C - - - -
 : 50°C ———

5V

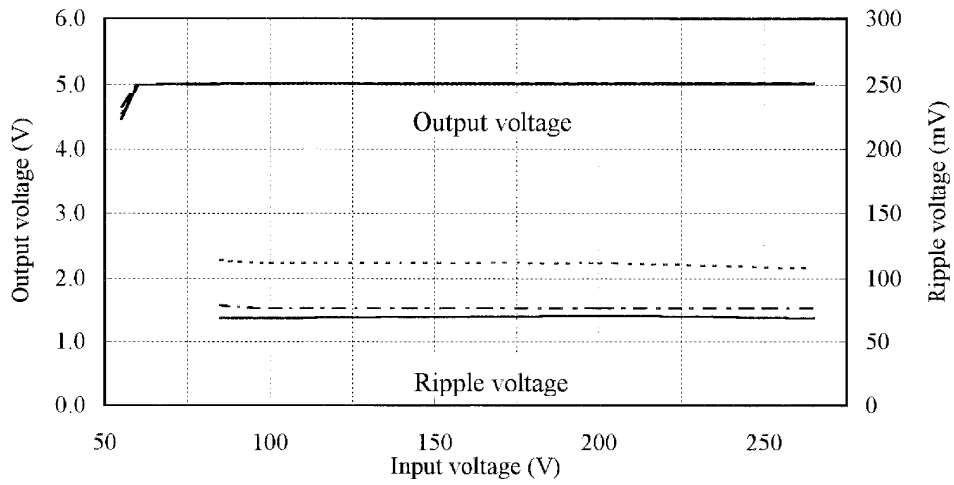

12V

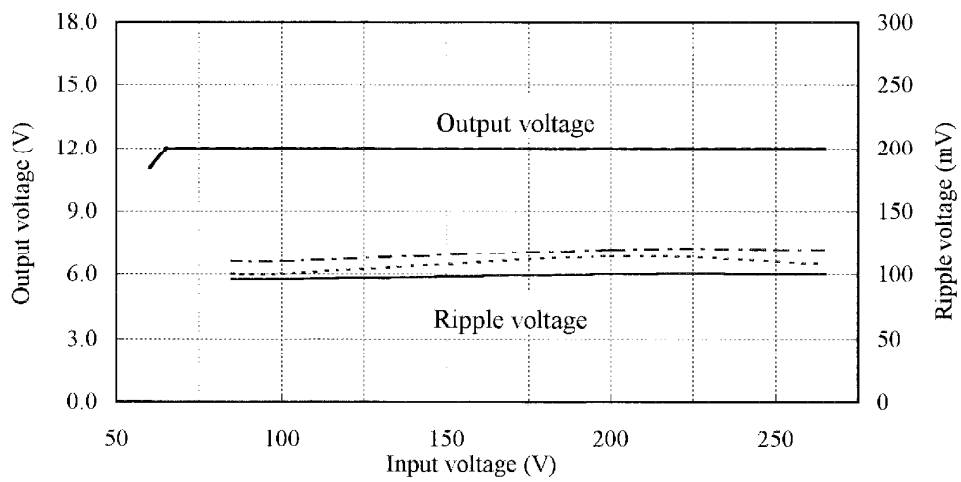

24V

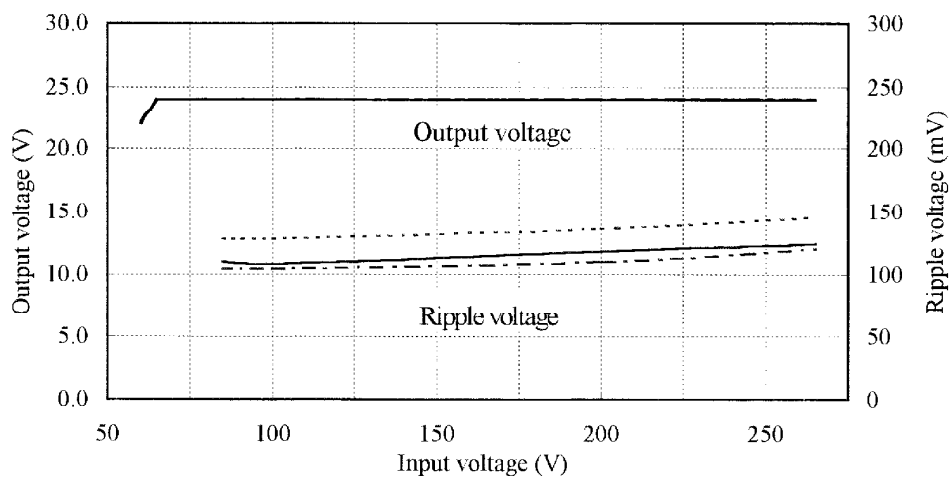

2.1 (3) 効率、入力電流対出力電流

Efficiency and Input current v.s. Output current

Conditions Vin : 85VAC
 : 100VAC - - - - -
 : 200VAC ————
 : 265VAC - - - - -
 Ta : 25°C

5V

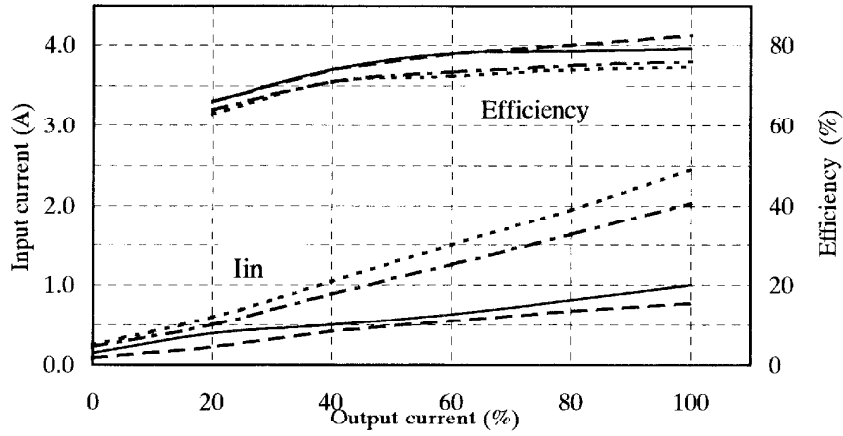

12V

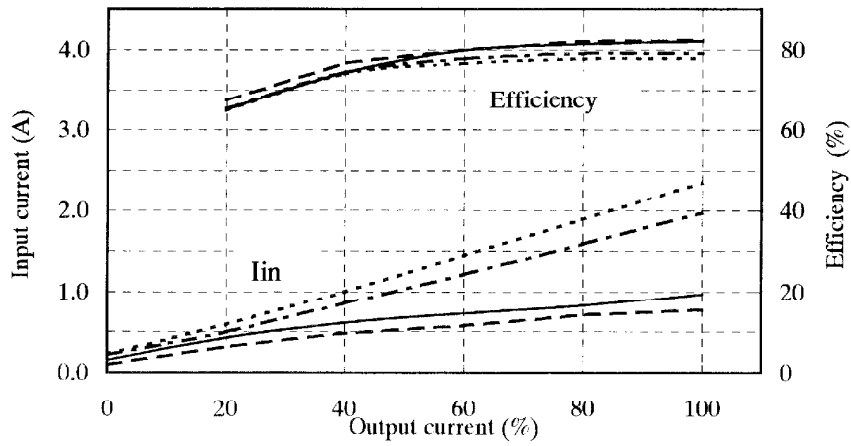

24V

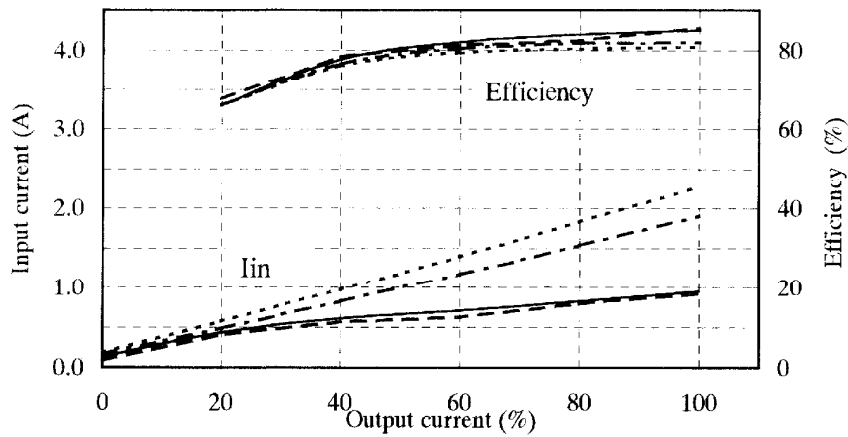

2.1 (4) 力率、入力電流対出力電流

Power factor and Input current v.s. Output current

Conditions V_{in} : 85VAC
 : 100VAC - - - - -
 : 200VAC ————
 : 265VAC - - - - -
 T_a : 25°C

5V

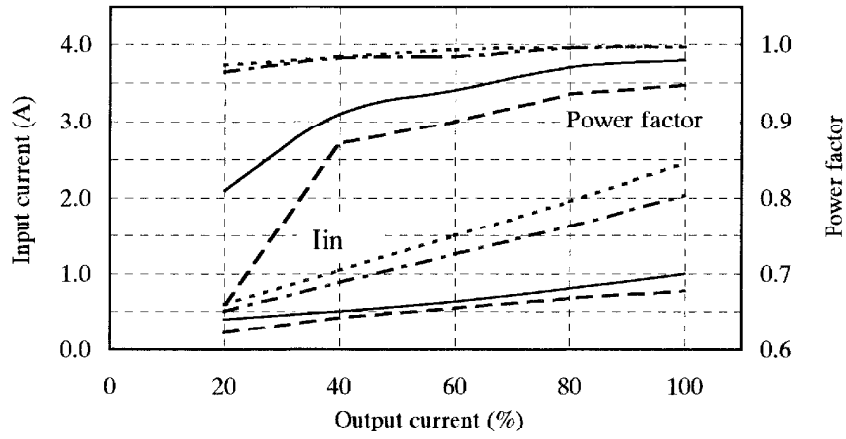

12V

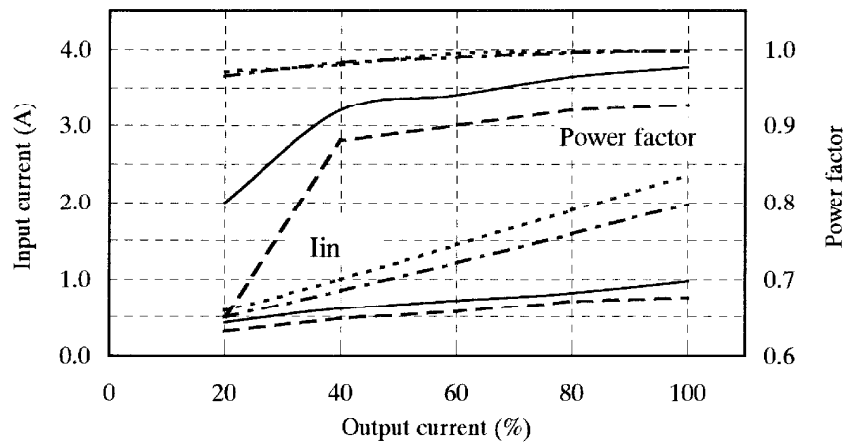

24V

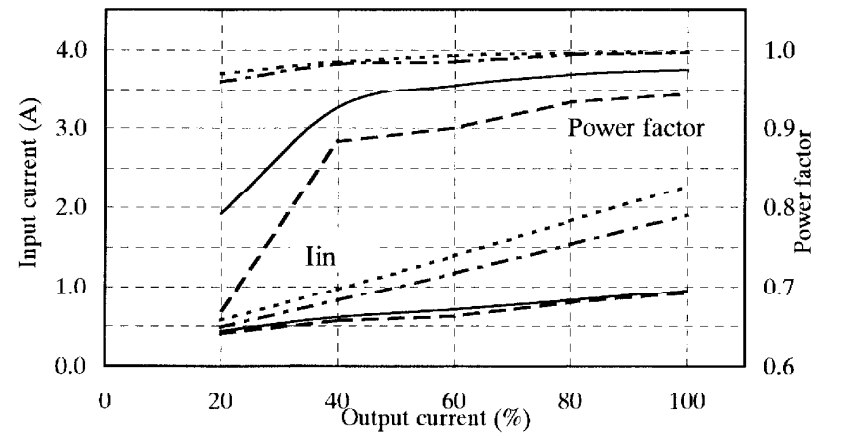

2.2 通電ドリフト特性
Warm up voltage drift characteristics

Conditions V_{in} : 100VAC
 I_o : 100%
 T_a : 25°C

5V

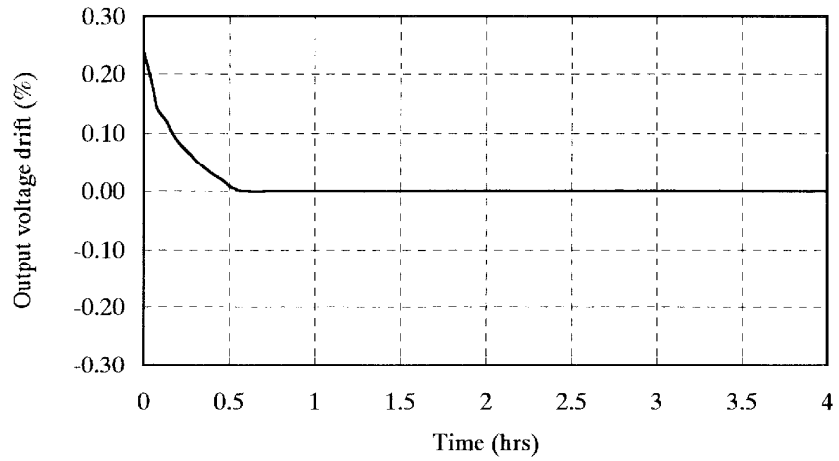

12V

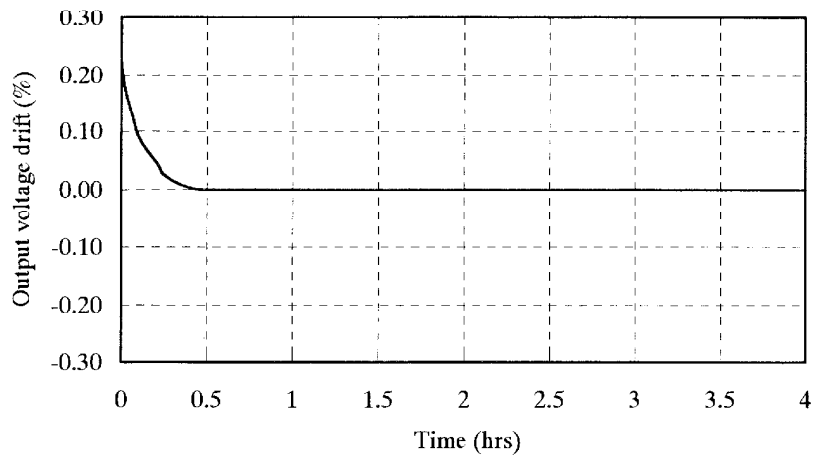

24V

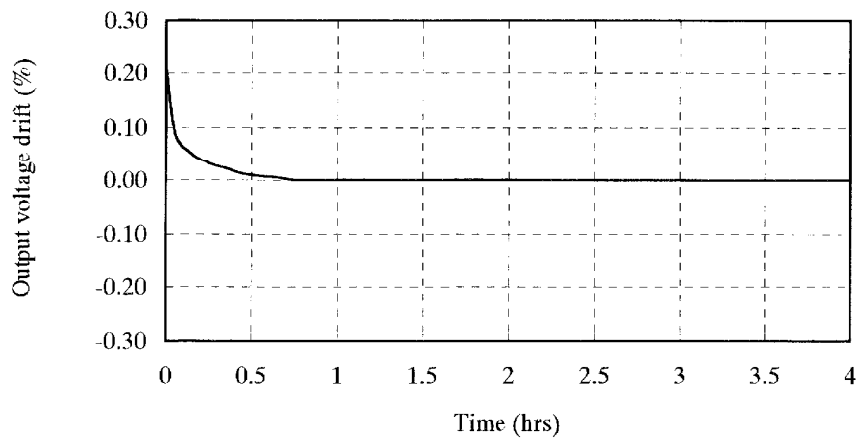

2.3 過電流保護特性
Over current protection (OCP) characteristics

Conditions Ta : -10°C
 : 25°C - - - - -
 : 50°C —————
Vin : 85-265VAC

5V

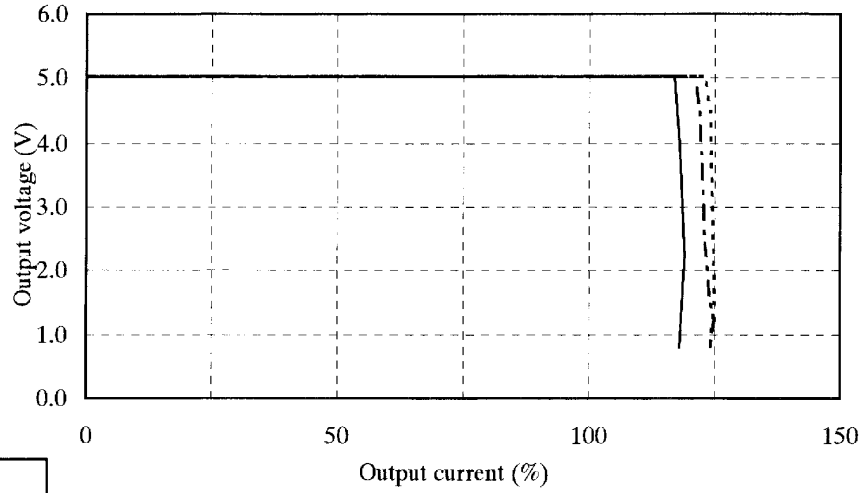

12V

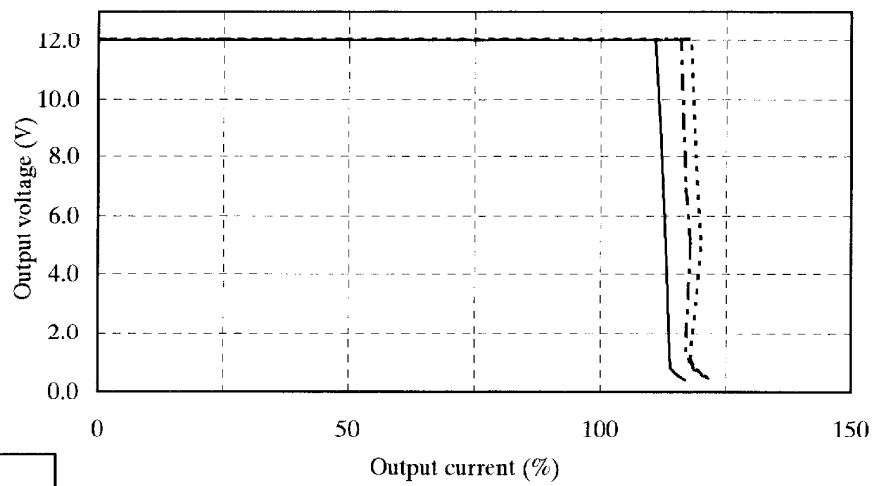

24V

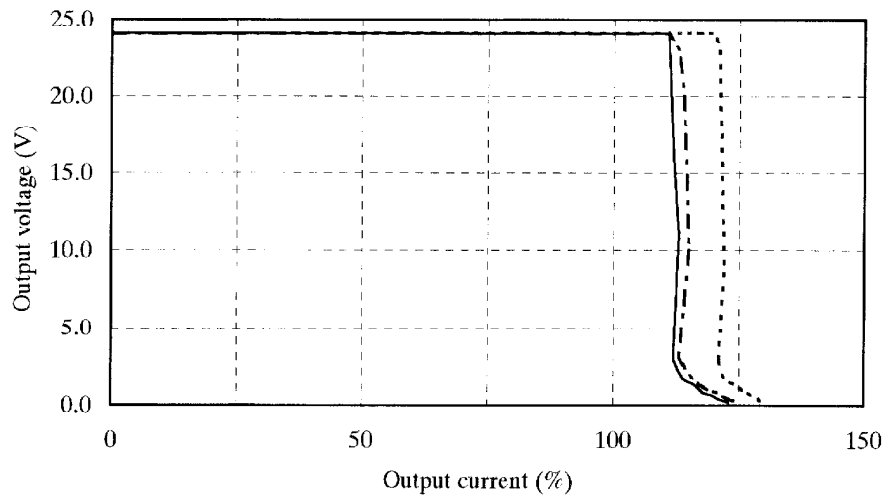

2.4 過電圧保護特性

Over voltage protection (OVP) characteristics

Conditions Vin : 100VAC

Iout : 0%

Ta : 25°C

5V

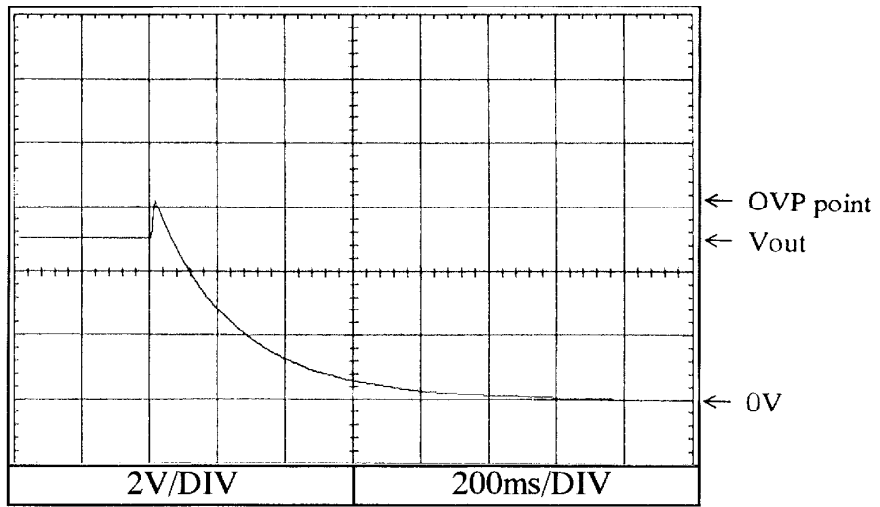

12V

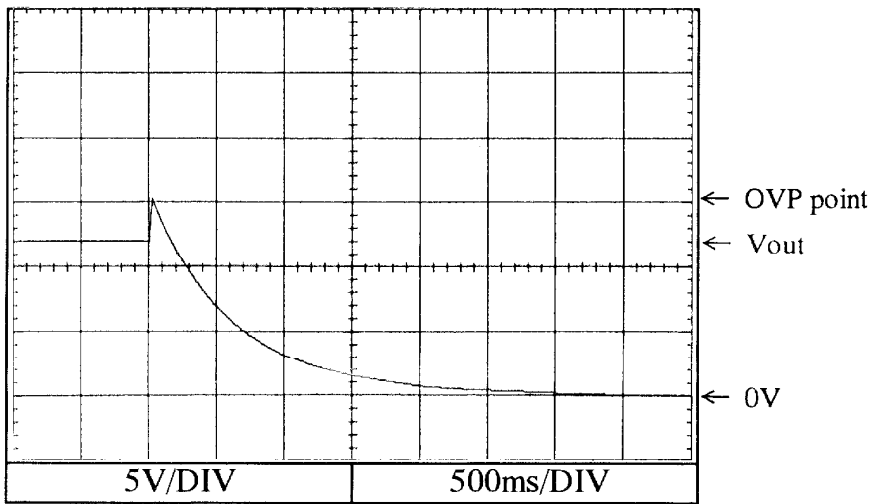

24V

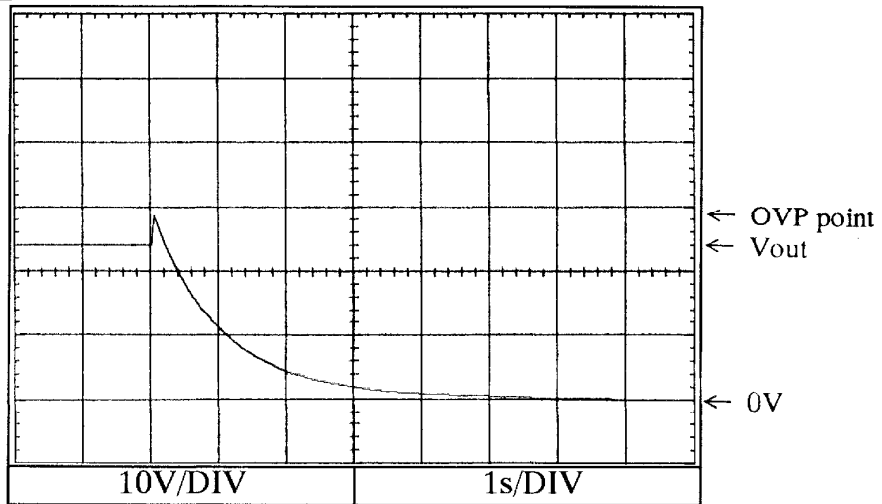

JWS150

2.5 出力立ち上がり特性 Output rise characteristics

Conditions V_{in} : 85VAC (A)
 : 100VAC (B)
 : 132VAC (C)
 I_{out} : 0%
 T_a : 25°C

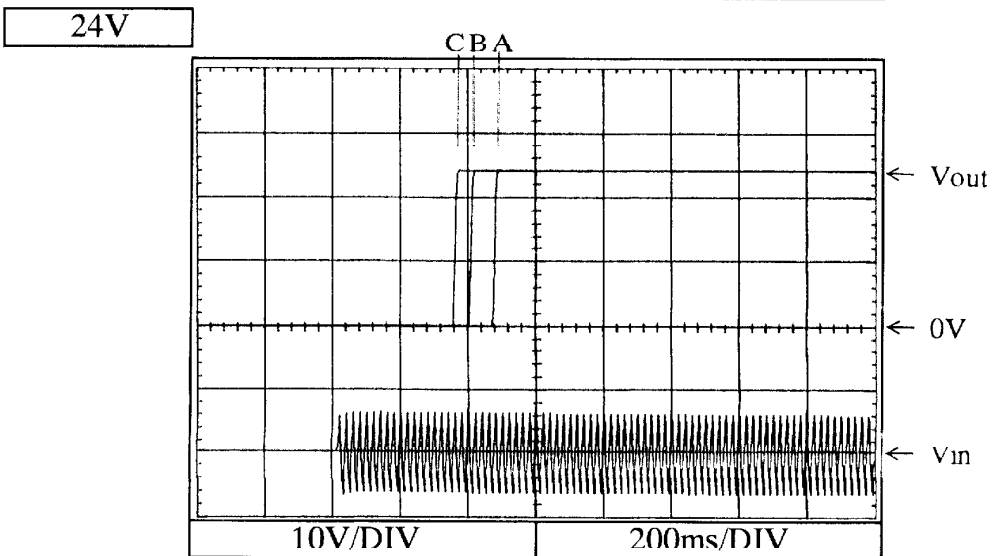
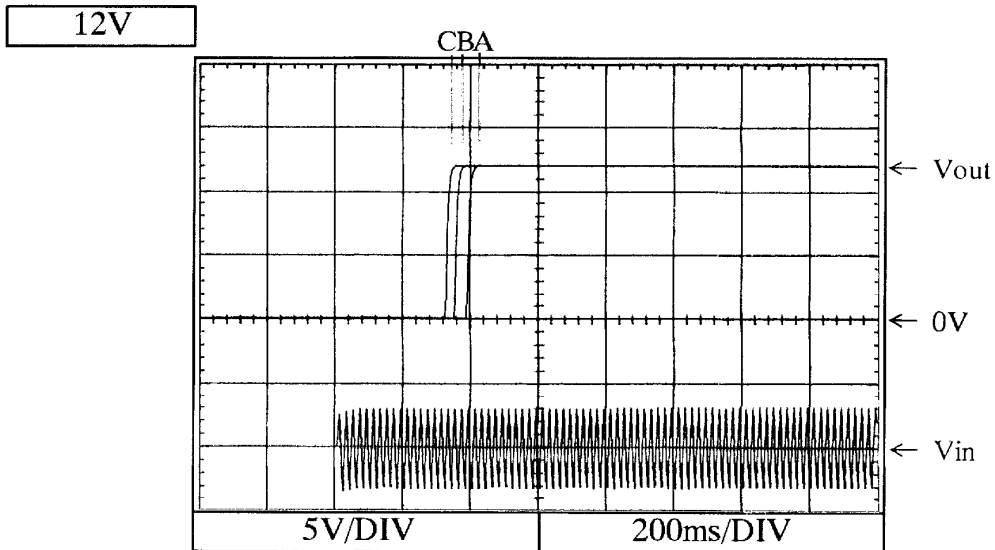
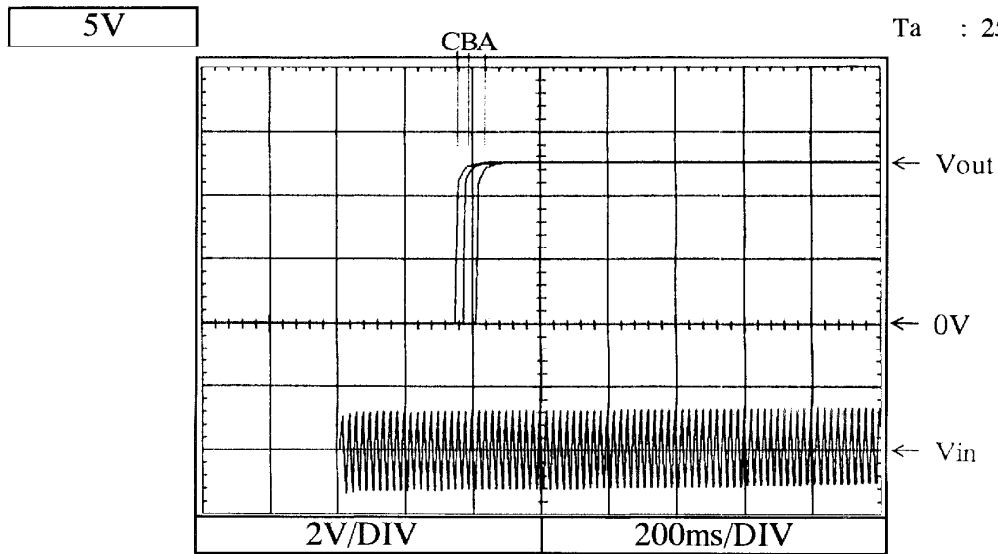

JWS150

2.5 出力立ち上がり特性 Output rise characteristics

Conditions V_{in} : 85VAC (A)
 : 100VAC (B)
 : 132VAC (C)
 I_{out} : 100%
 T_a : 25°C

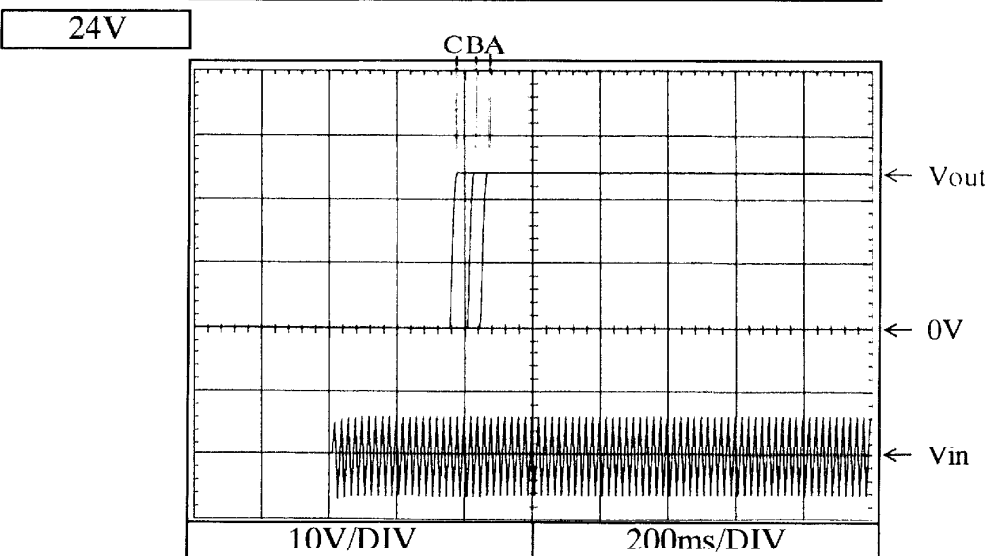
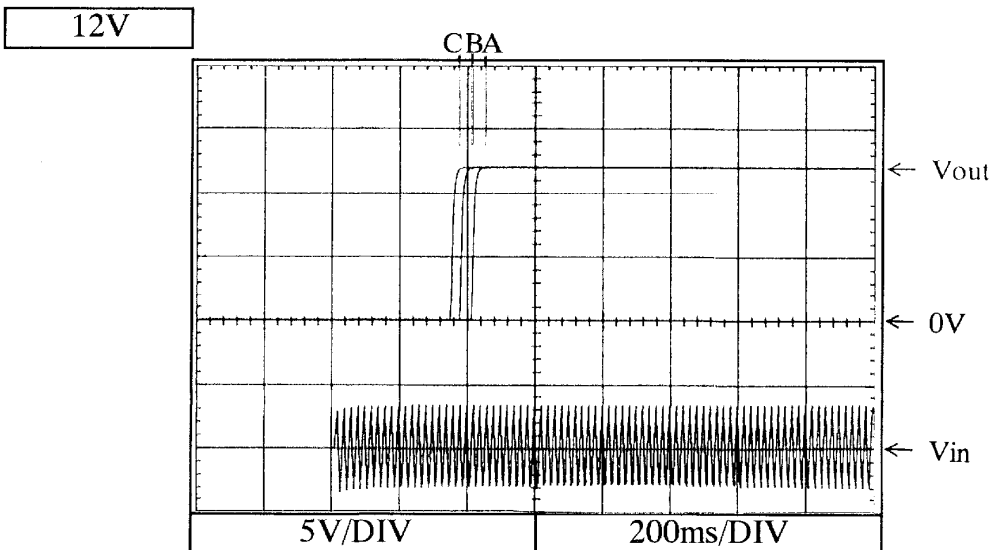
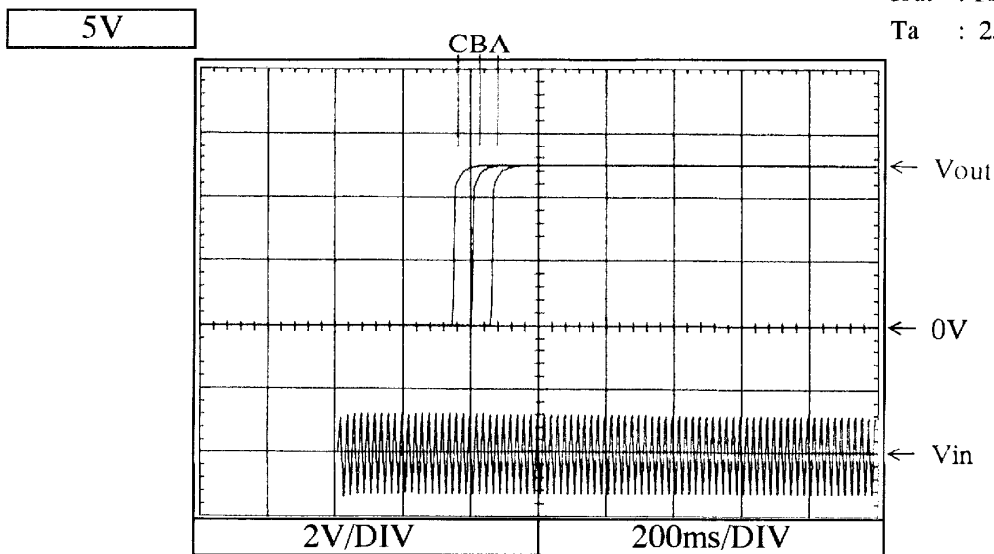

JWS150

2.5 出力立ち上がり特性 Output rise characteristics

Conditions Vin : 170VAC (A)
 : 200VAC (B)
 : 265VAC (C)
Iout : 0%
Ta : 25°C

5V

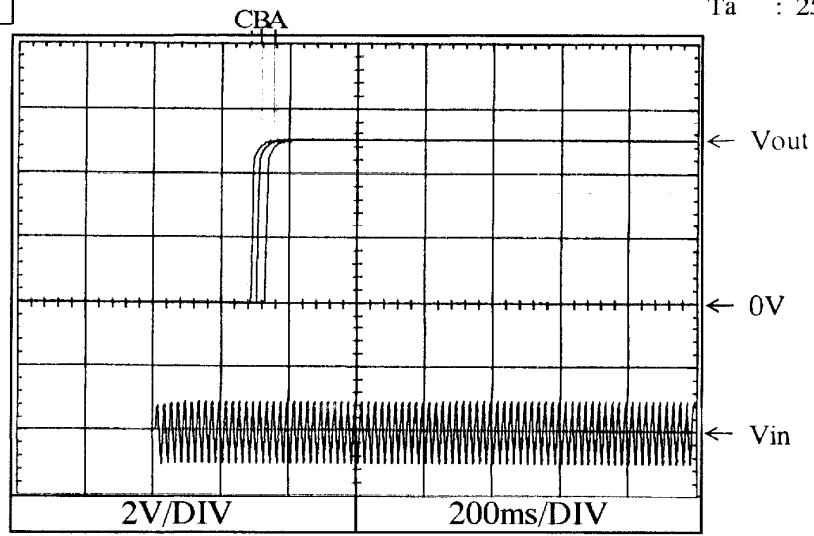

12V

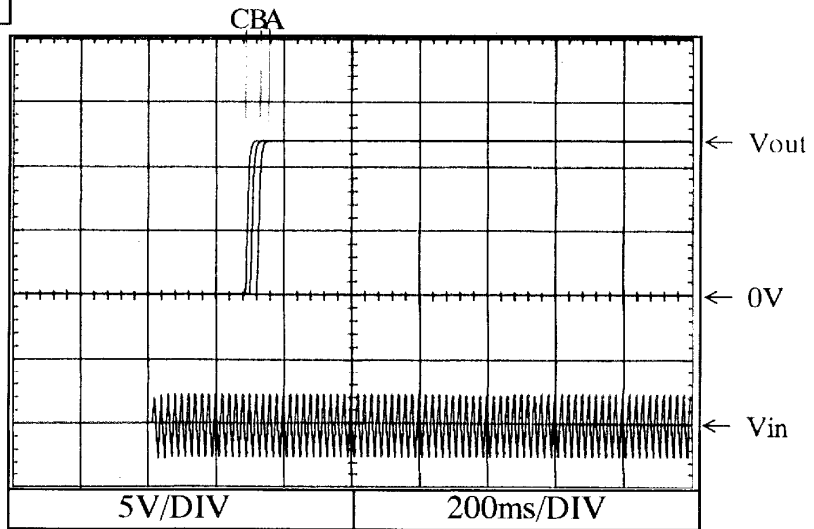

24V

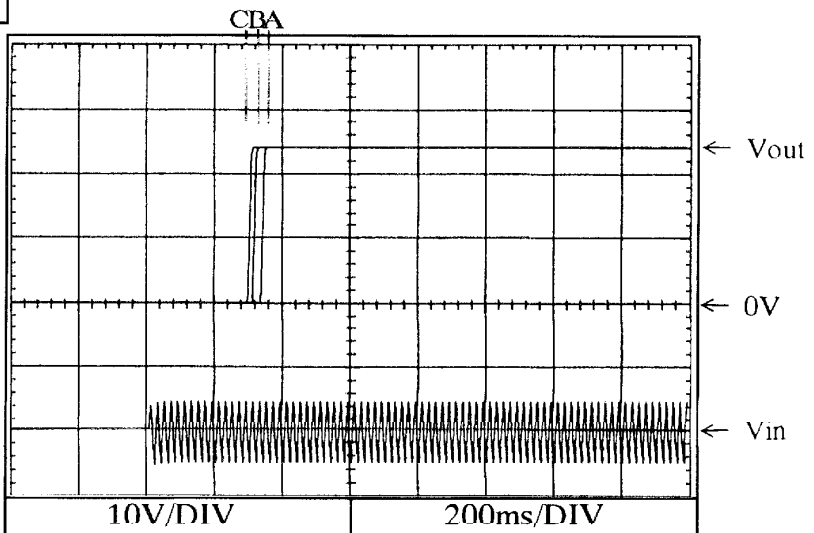

JWS150

Conditions Vin : 170VAC (A)
: 200VAC (B)
: 265VAC (C)
Iout : 100%
Ta : 25°C

2.5 出力立ち上がり特性 Output rise characteristics

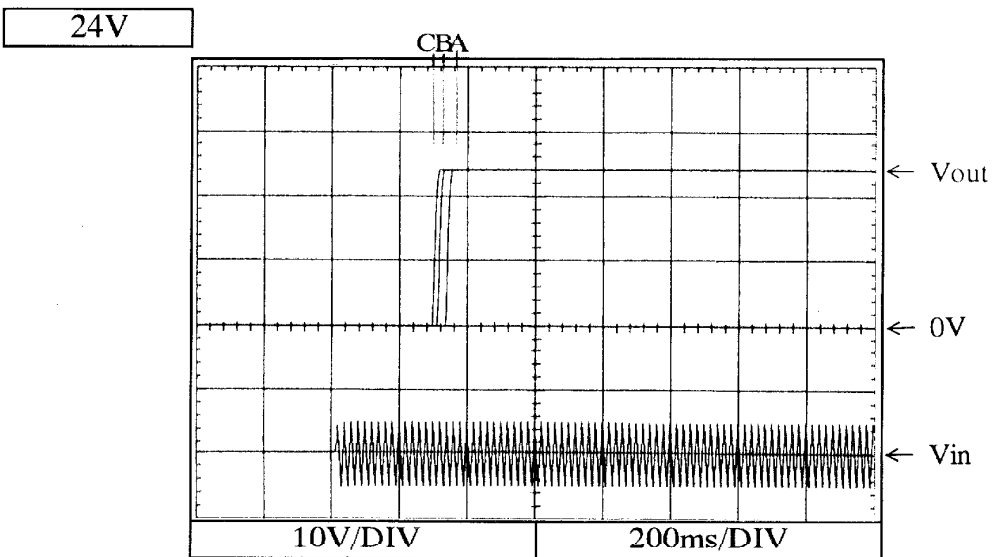
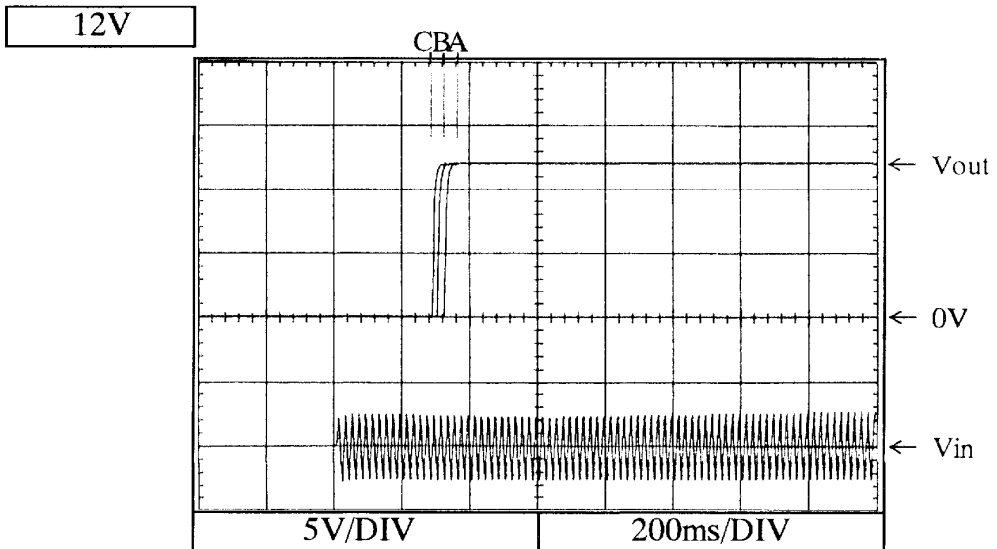
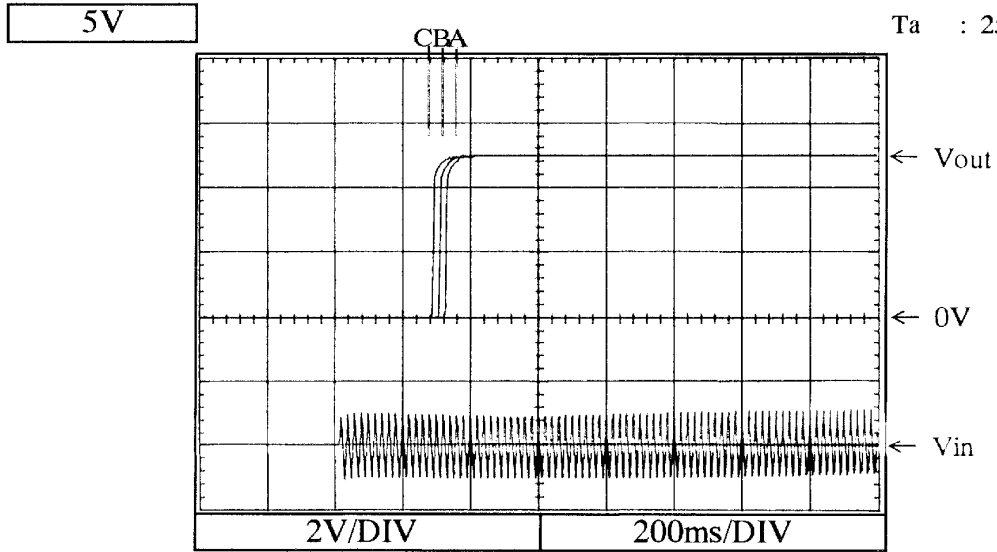

JWS150

2.6 出力立ち下がり特性 Output fall characteristics

Conditions Vin : 85VAC (A)
 : 100VAC (B)
 : 132VAC (C)
Iout : 0%
Ta : 25°C

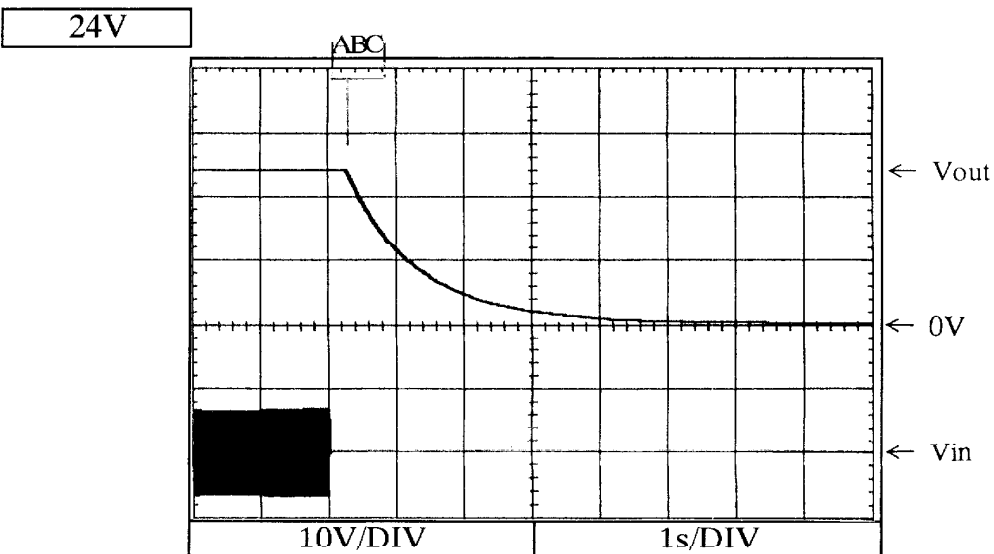
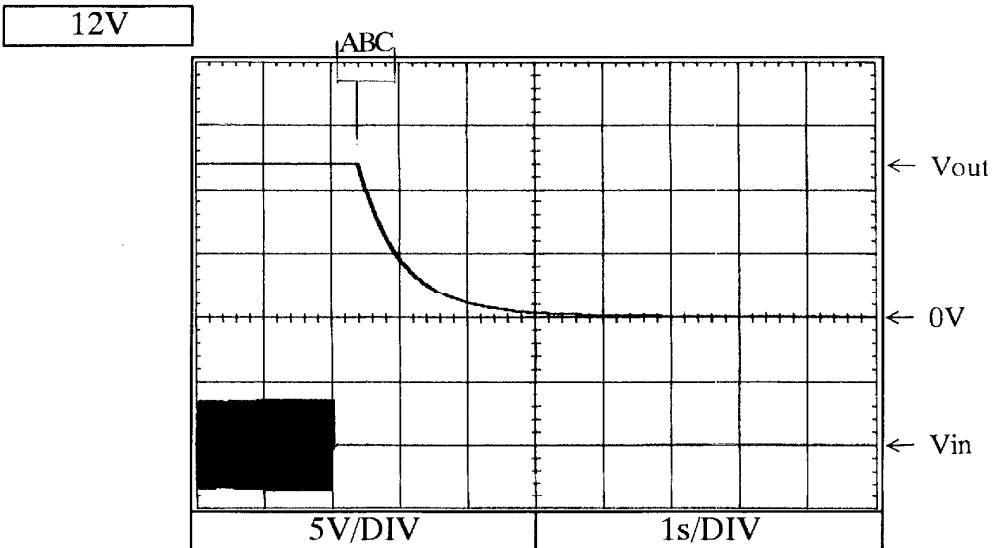
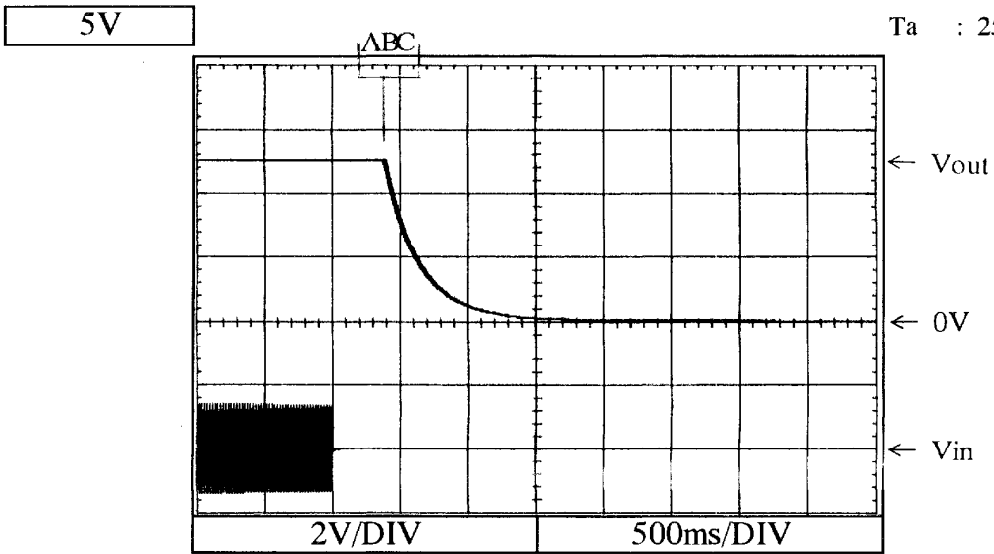

JWS150

2.6 出力立ち下がり特性 Output fall characteristics

Conditions Vin : 85VAC (A)
 : 100VAC (B)
 : 132VAC (C)
Iout : 100%
Ta : 25°C

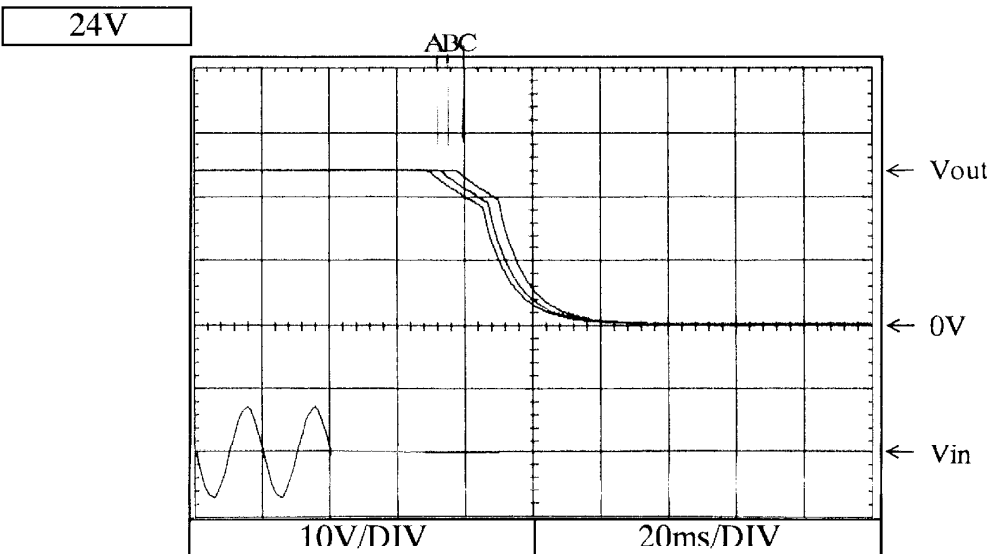
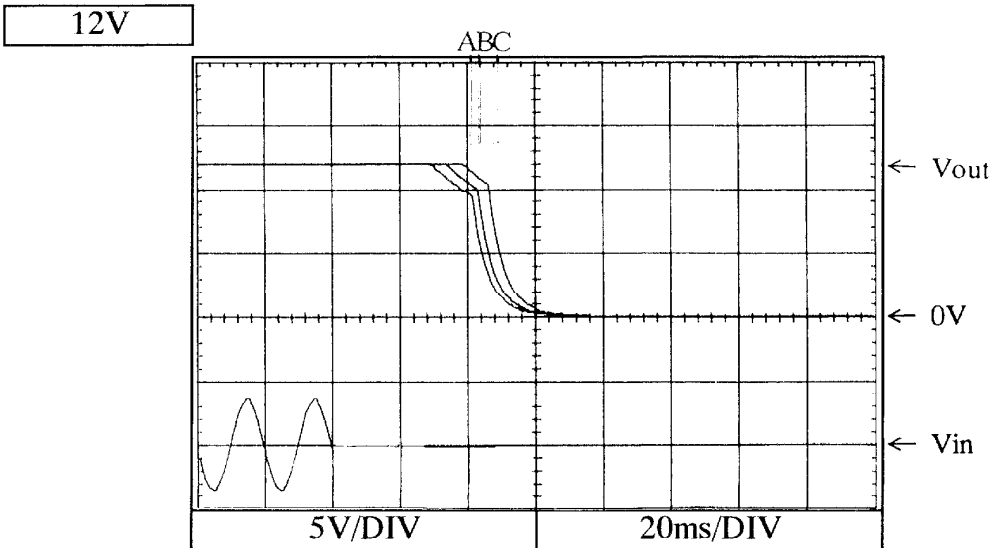
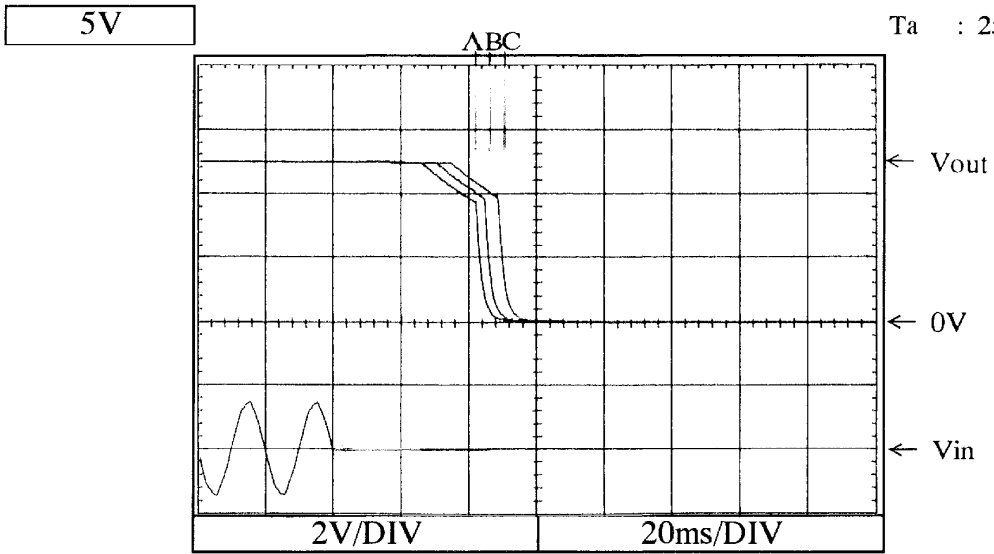

JWS150

2.6 出力立ち下がり特性 Output fall characteristics

Conditions Vin : 170VAC (A)
 : 200VAC (B)
 : 265VAC (C)
Iout : 0%
Ta : 25°C

5V

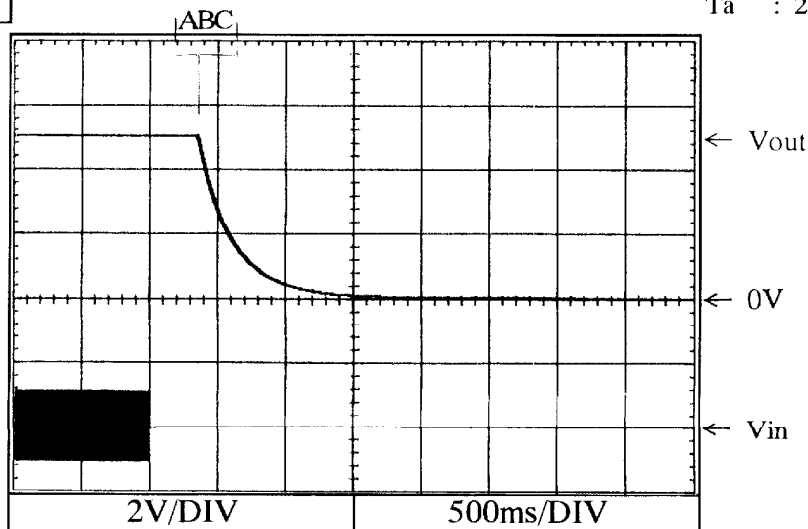

12V

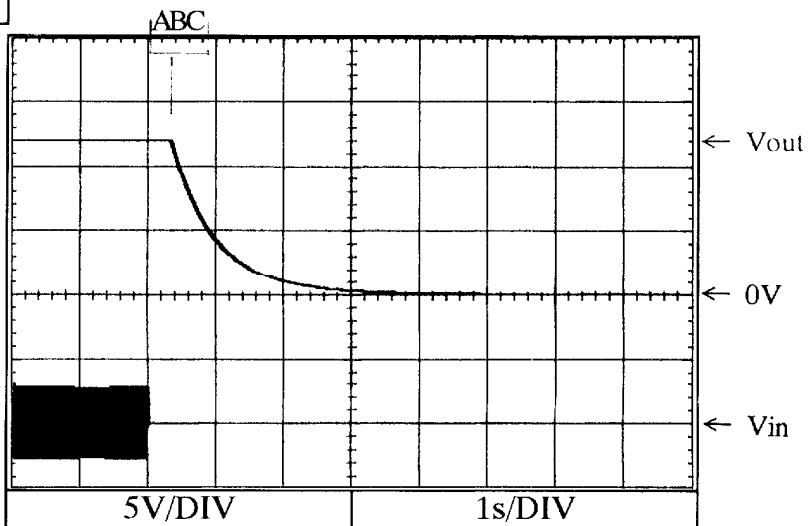

24V

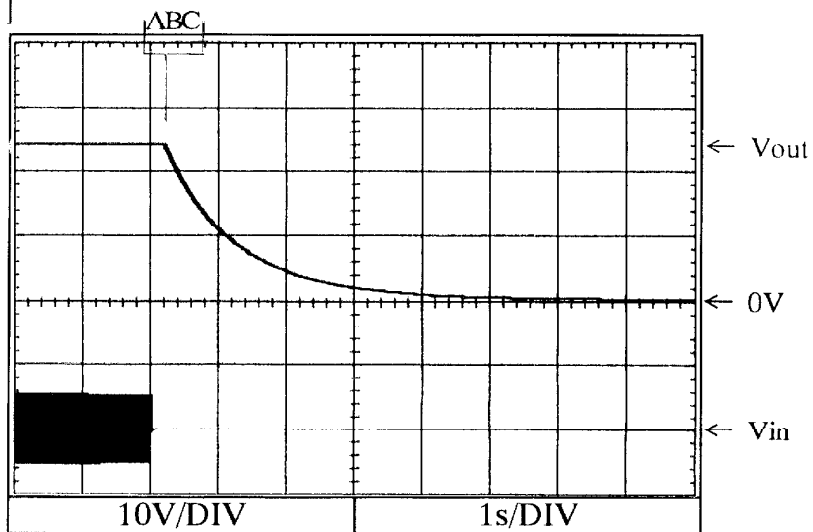

JWS150

2.6 出力立ち下がり特性 Output fall characteristics

Conditions Vin : 170VAC (A)
 : 200VAC (B)
 : 265VAC (C)
Iout : 100%
Ta : 25°C

5V

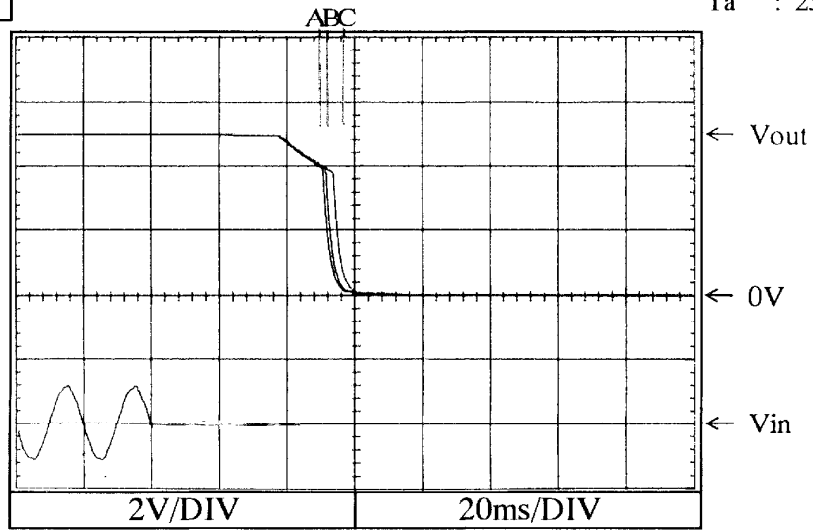

12V

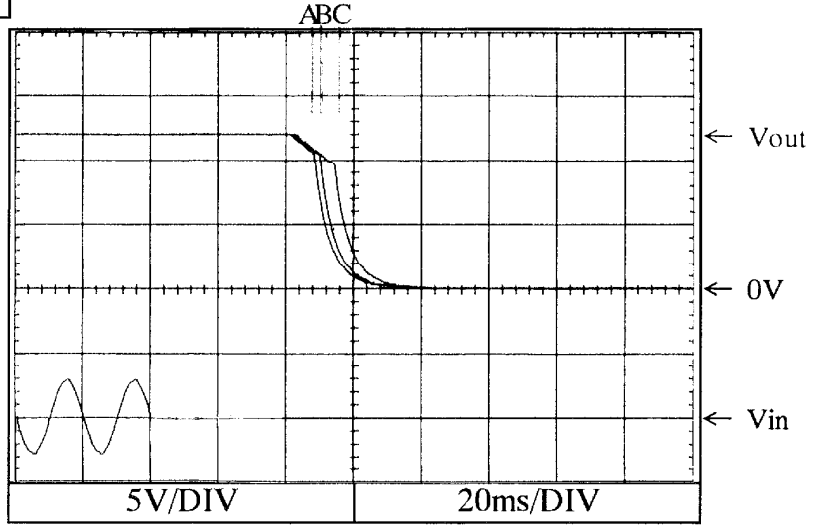

24V

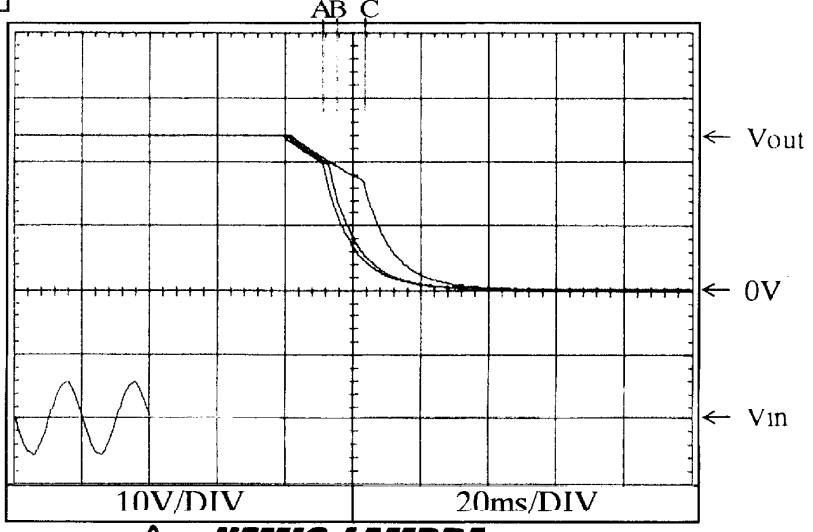

2.7 ON/OFFコントロール時出力立ち上がり特性

Output rise characteristics with ON/OFF CONTROL

標準品 JWS150-*/R にて対応

For alternative standard model JWS150-*/R

Conditions V_{in} : 100VAC

I_{out} : 100%

T_a : 25°C

5V

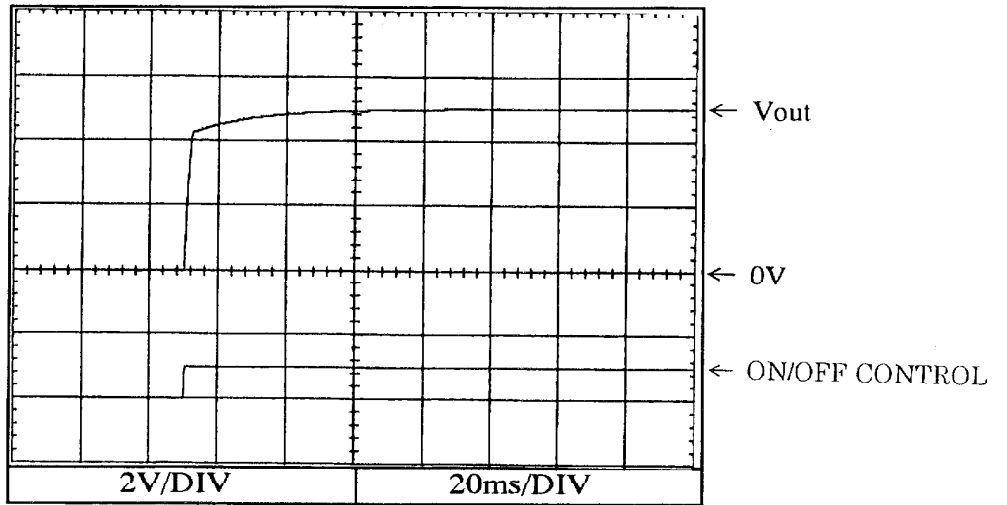

12V

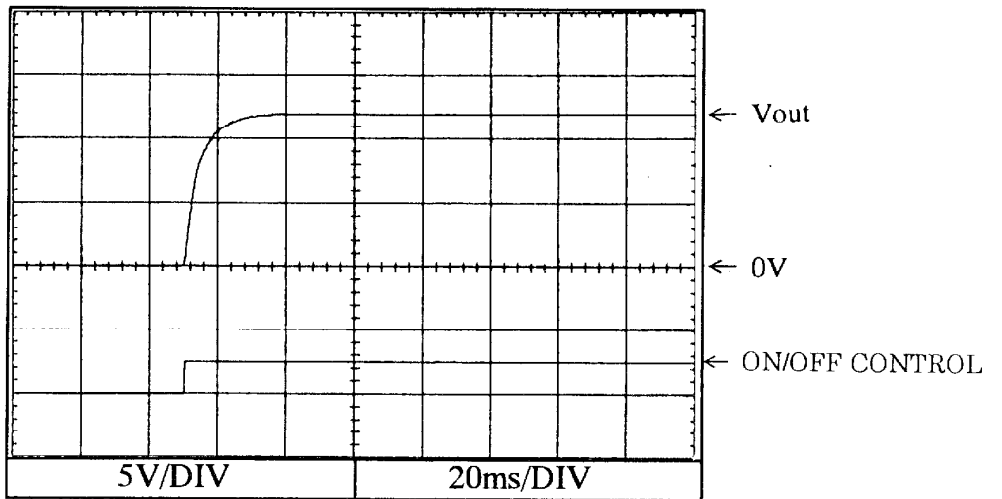

24V

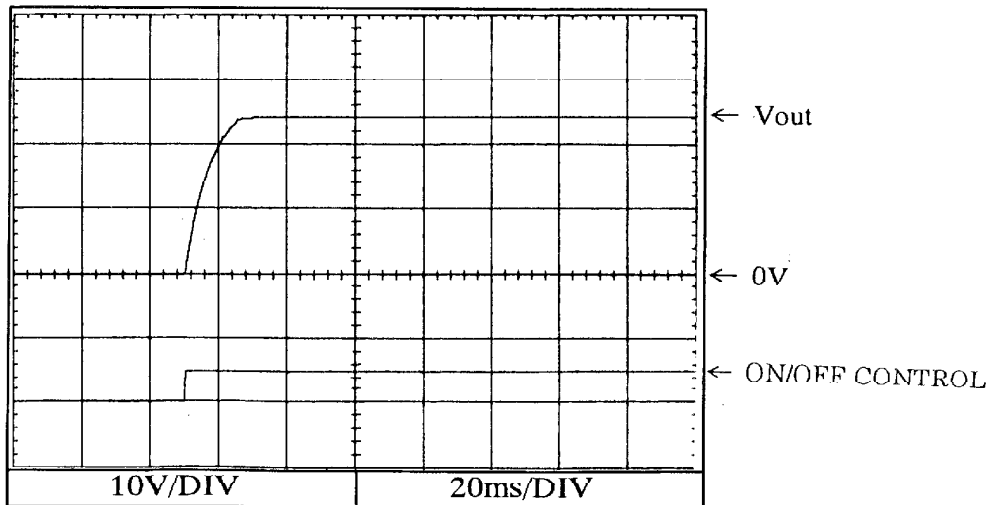

2.8 ON/OFFコントロール時出力立ち下がり特性
Output fall characteristics with ON/OFF CONTROL
準標準品 JWS150-*/R にて対応
For alternative standard model JWS150-*/R

Conditions Vin : 100VAC
Iout : 100%
Ta : 25°C

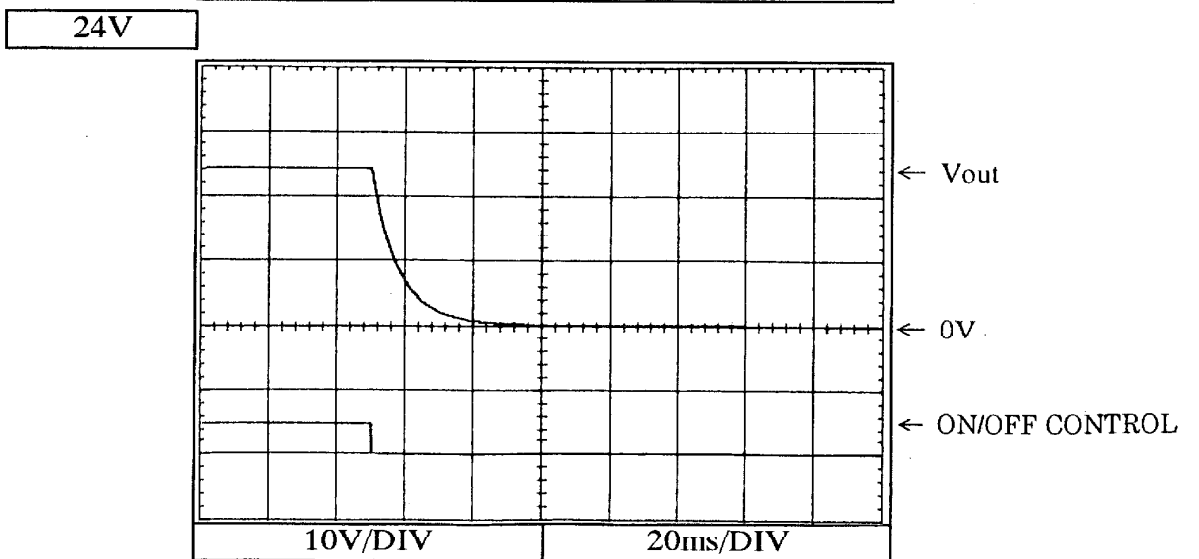
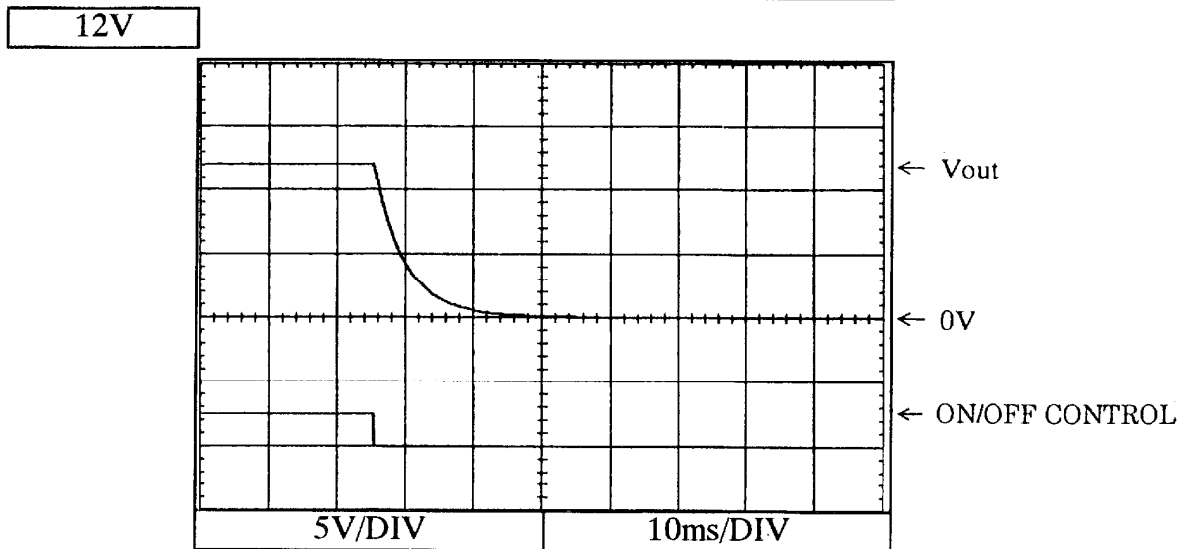
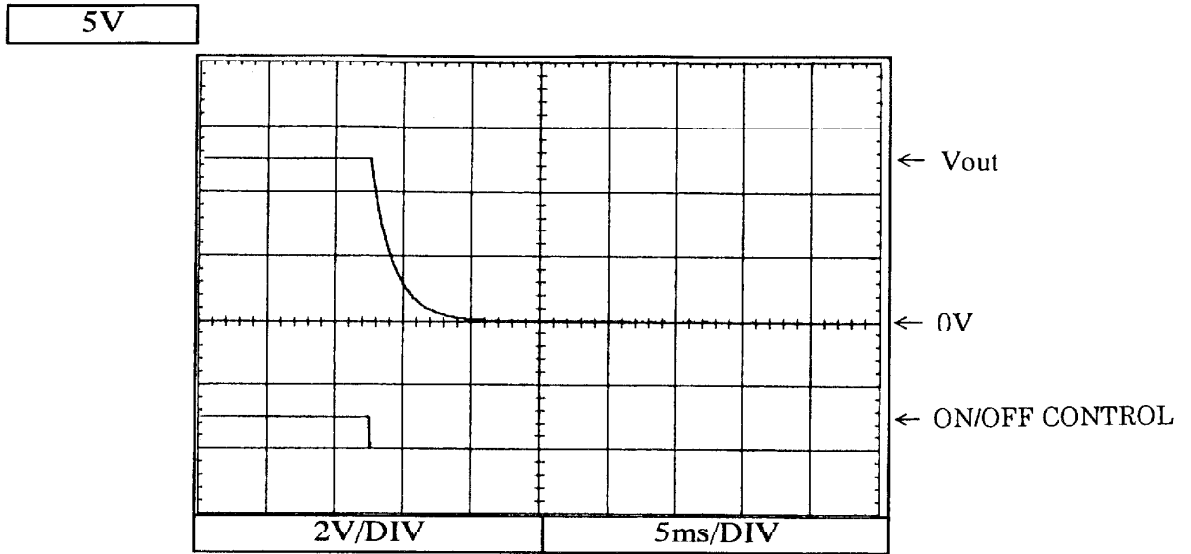

2.9 出力保持時間特性
Hold up time characteristics

Conditions V_{in} : 100VAC -----
 : 200VAC —————
 T_a : 25°C

5V

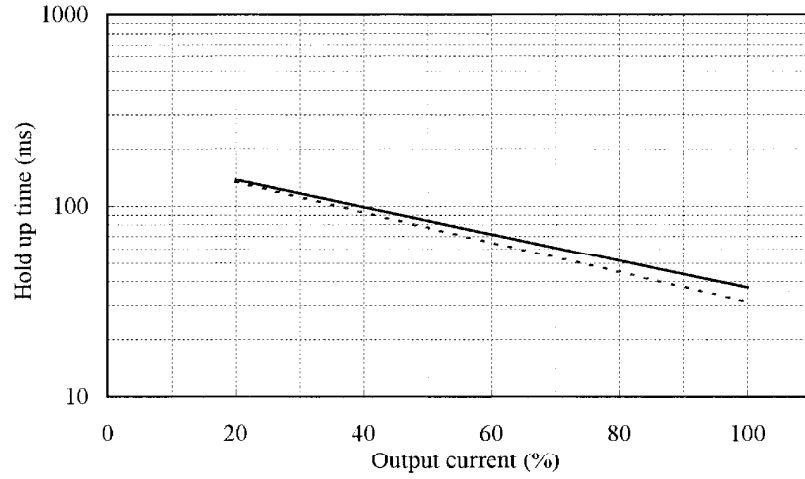

12V

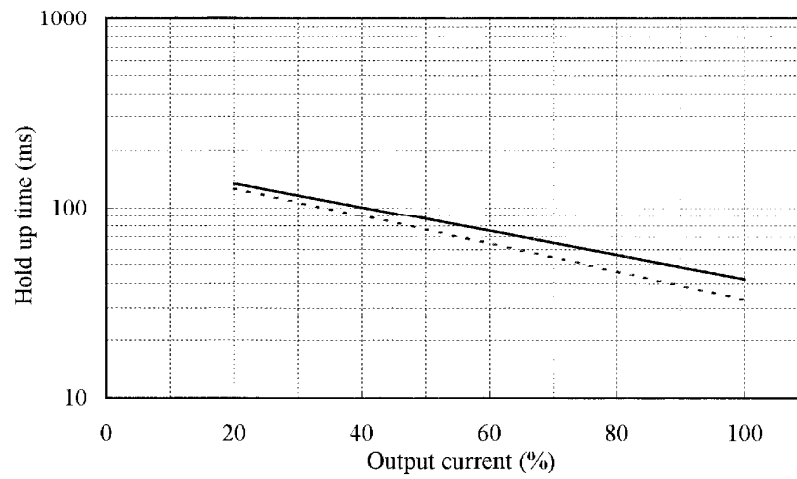

24V

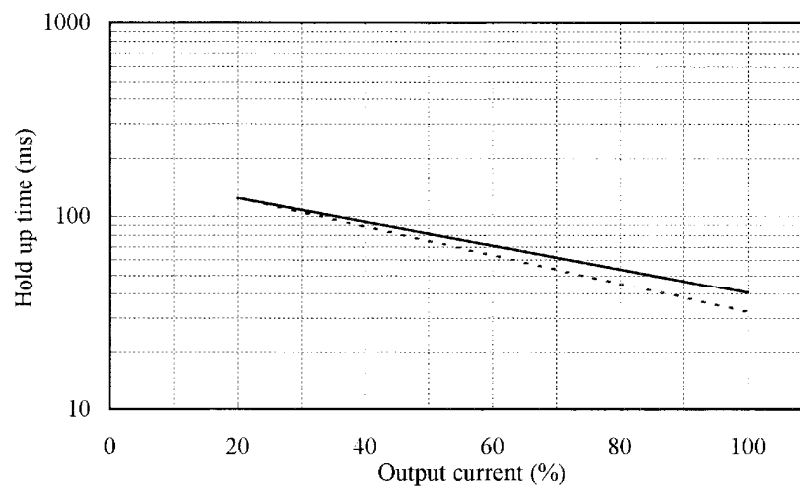

2.10 過渡応答 (入力急変) 特性
Dynamic line response characteristics

Conditions Vin : 85VAC \leftrightarrow 132VAC
Iout : 100%
Ta : 25°C

5V

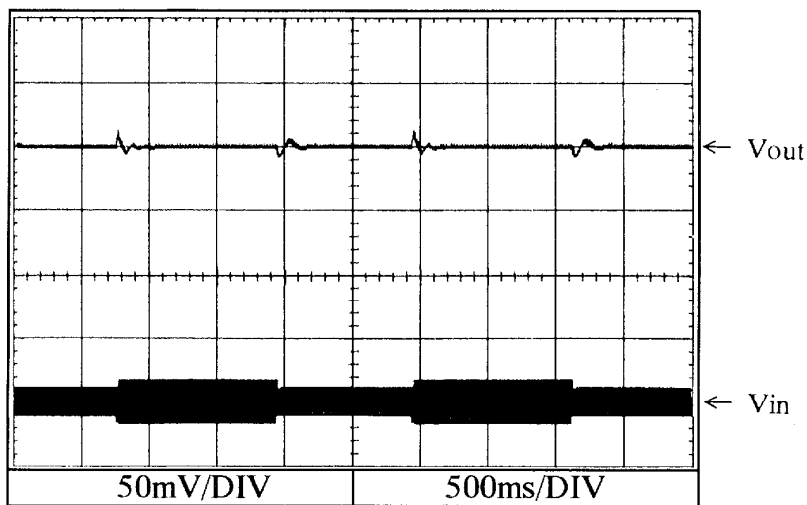

12V

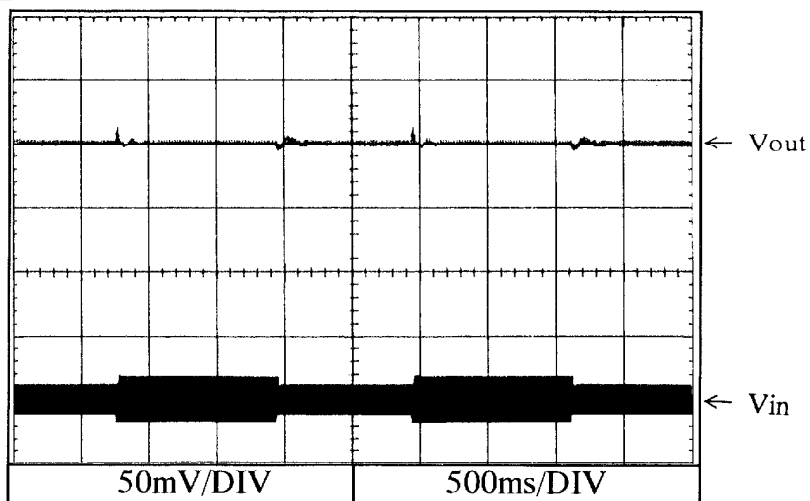

24V

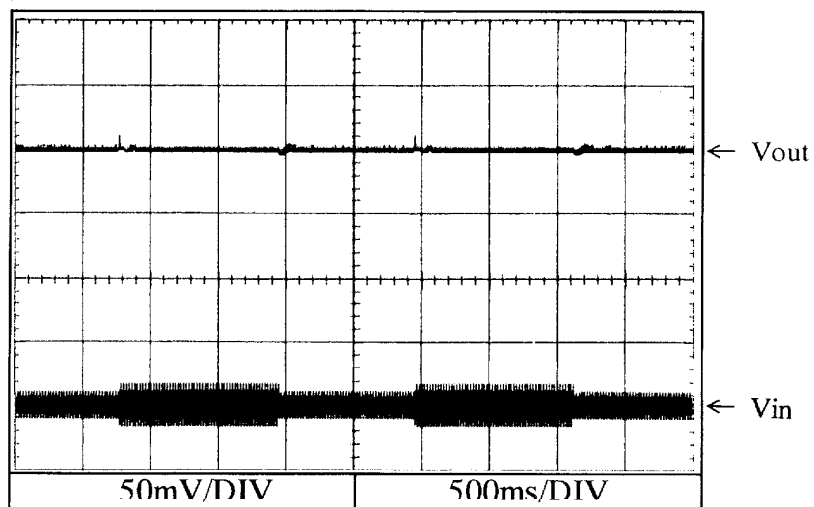

2.10 過渡応答 (入力急変) 特性
Dynamic line response characteristics

Conditions V_{in} : 170VAC \leftrightarrow 265VAC
 I_{out} : 100%
 T_a : 25°C

5V

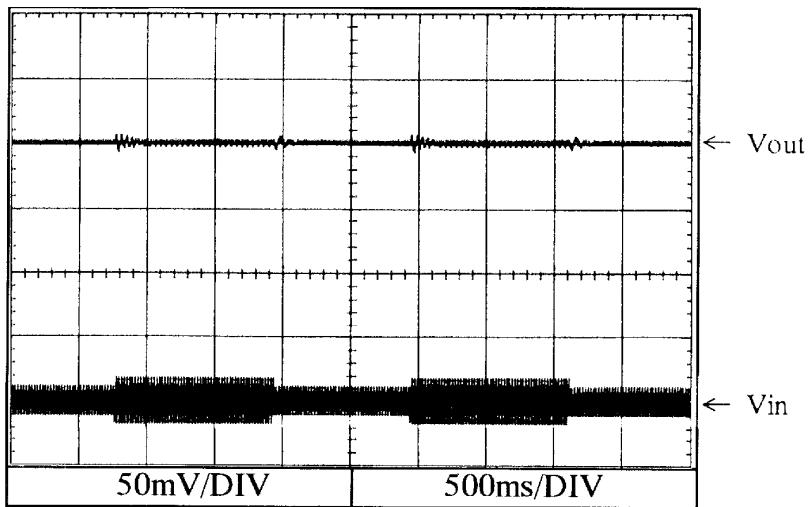

12V

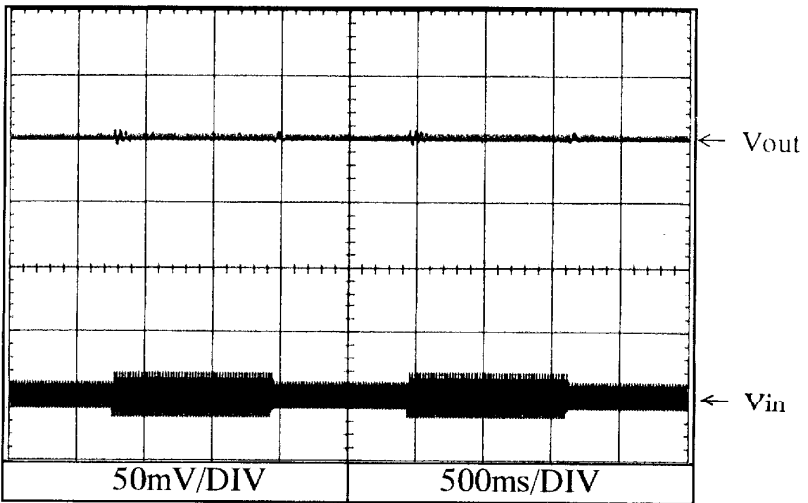

24V

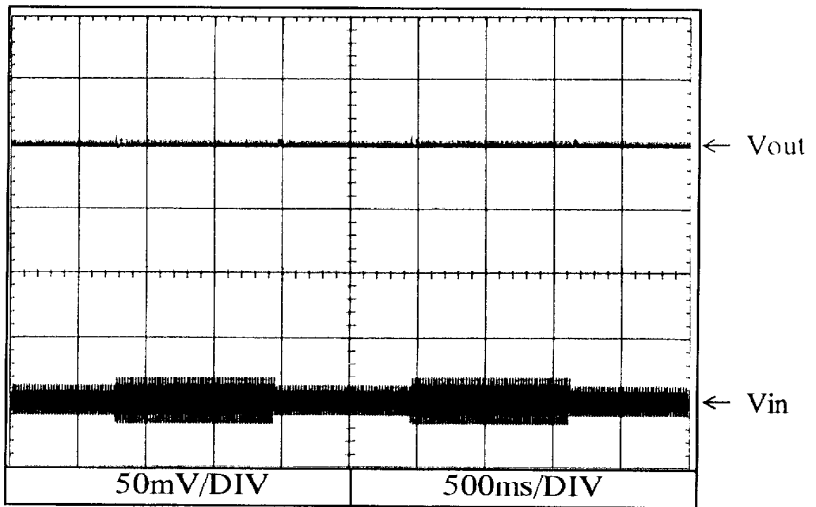

2.11 過渡応答 (負荷急変) 特性
Dynamic load response characteristics

Conditions Vin : 100VAC
Ta : 25°C

5V

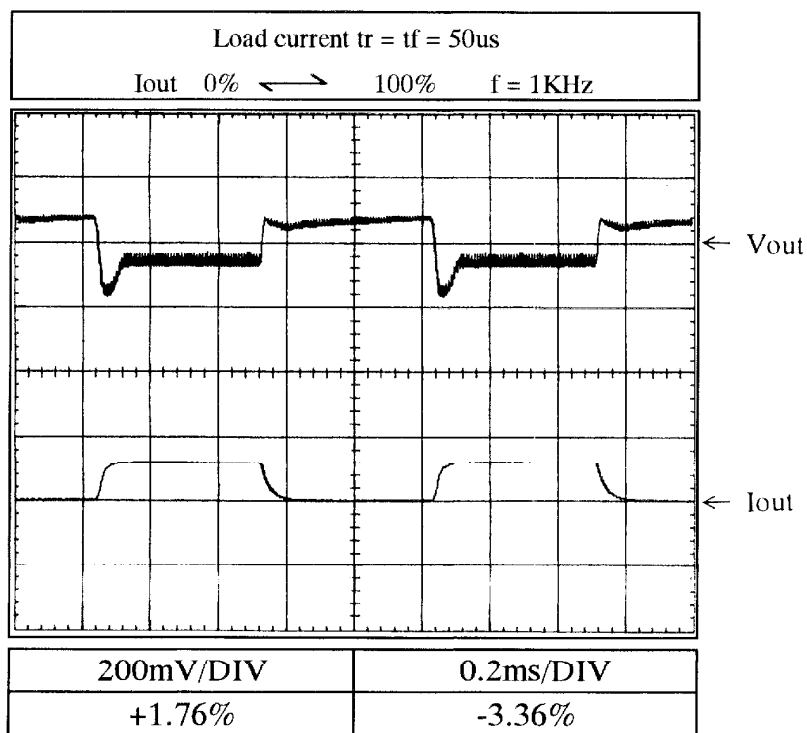
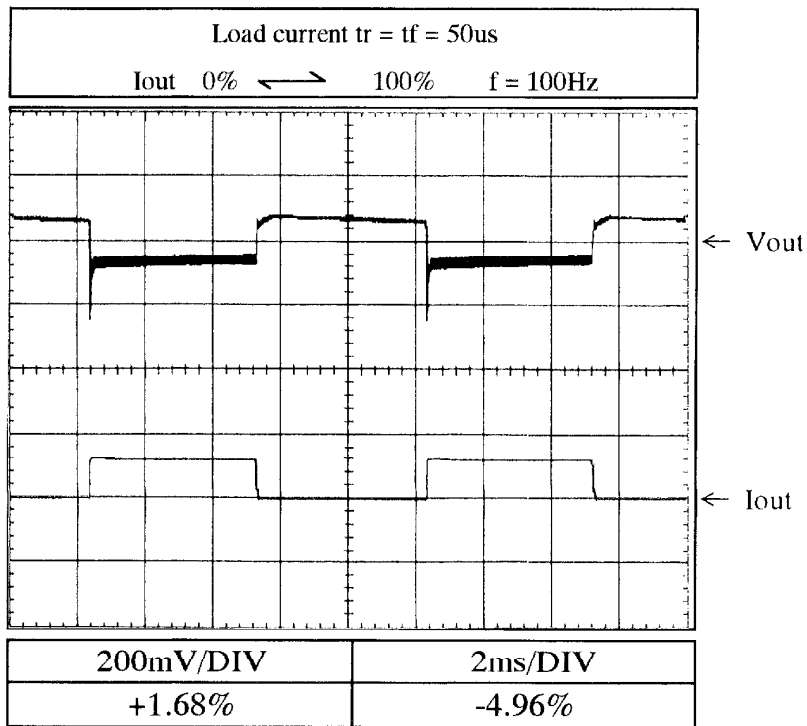

2.11 過渡応答（負荷急変）特性
Dynamic load response characteristics

Conditions Vin : 200VAC
Ta : 25°C

5V

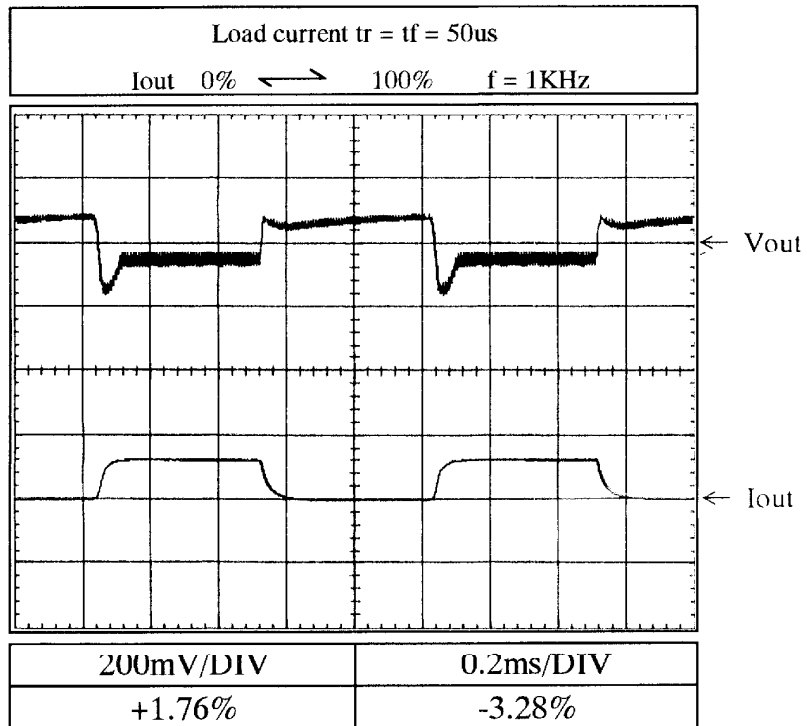
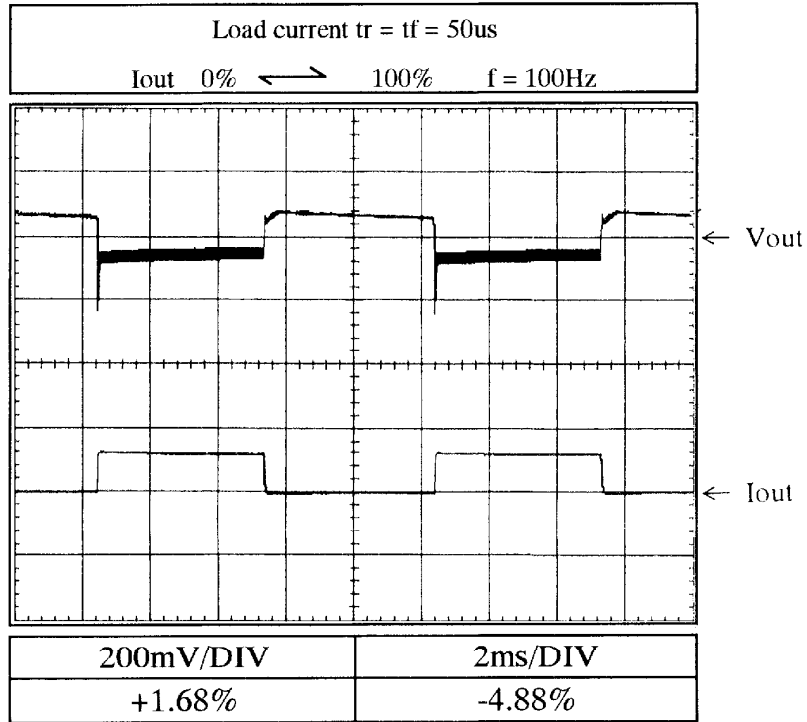

2.11 過渡応答 (負荷急変) 特性
Dynamic load response characteristics

Conditions Vin : 100VAC
Ta : 25°C

5V

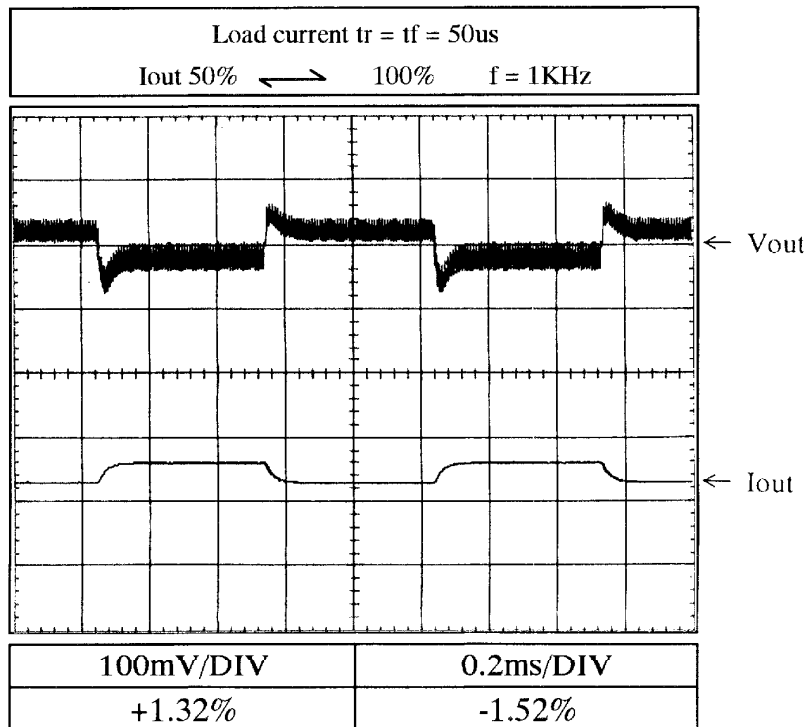
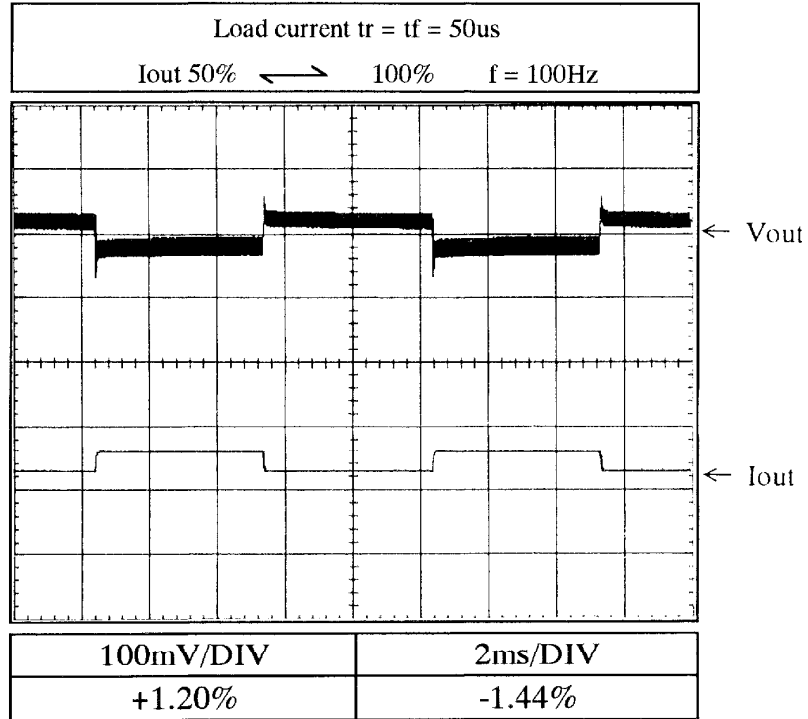

2.11 過渡応答 (負荷急変) 特性
Dynamic load response characteristics

Conditions Vin : 200VAC
Ta : 25°C

5V

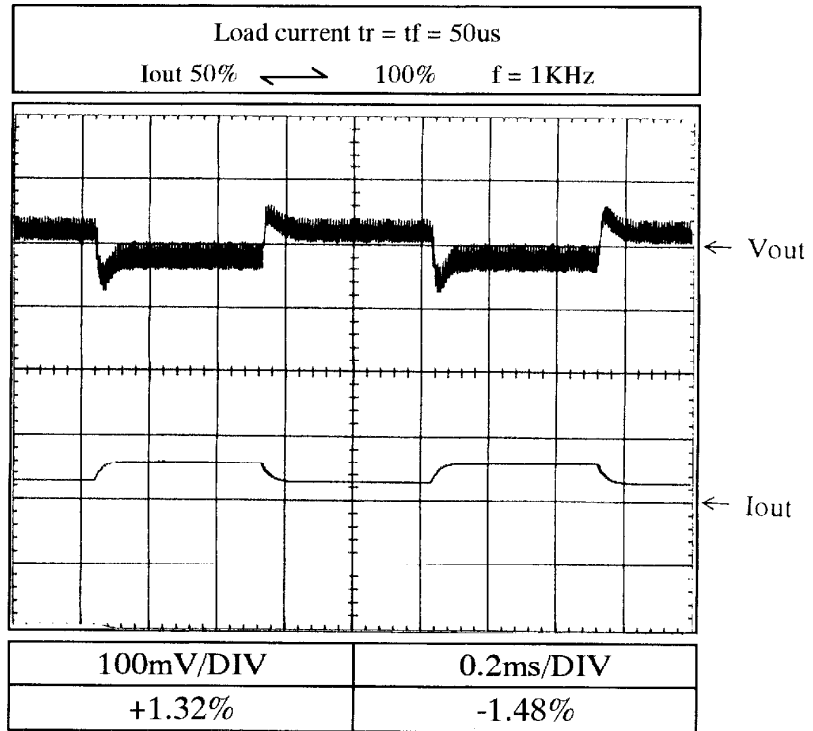
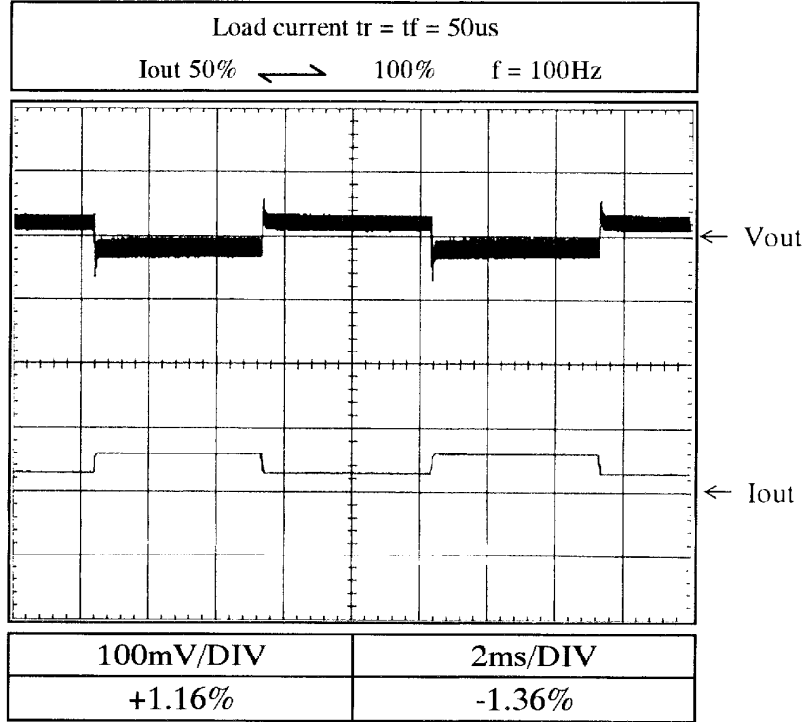

2.11 過渡応答 (負荷急変) 特性
Dynamic load response characteristics

Conditions Vin : 100VAC
Ta : 25°C

12V

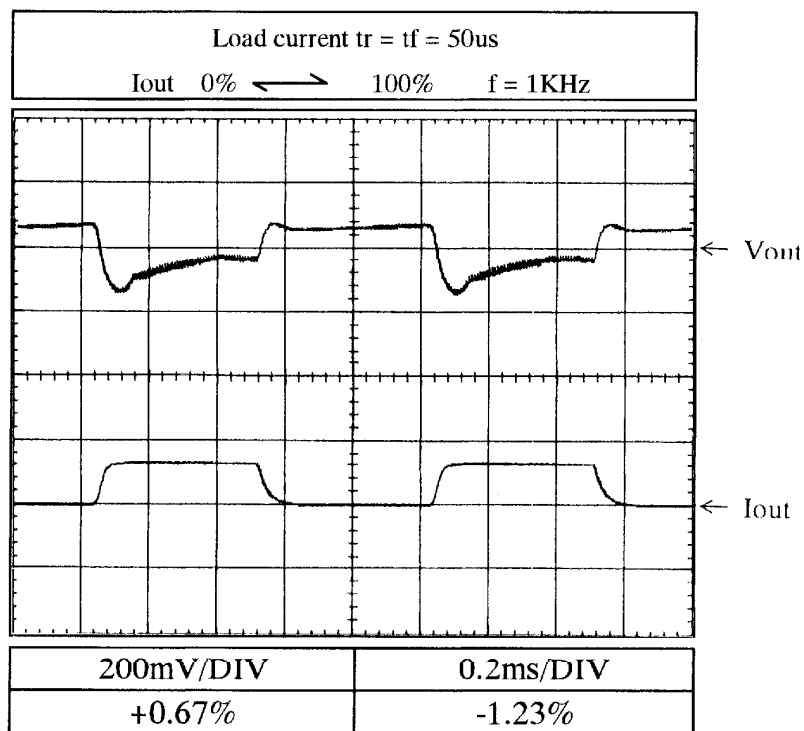
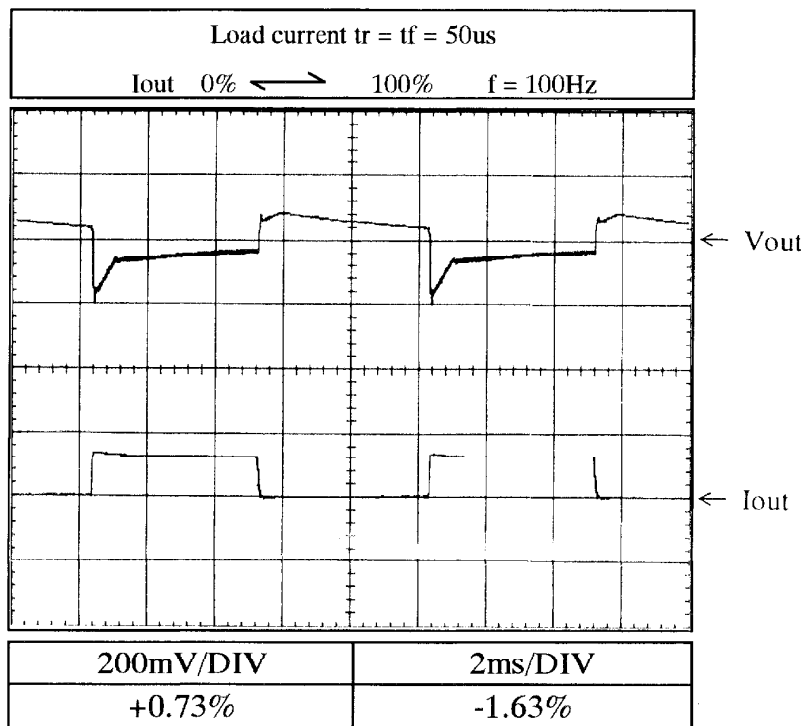

2.11 過渡応答 (負荷急変) 特性
Dynamic load response characteristics

Conditions Vin : 200VAC
Ta : 25°C

12V

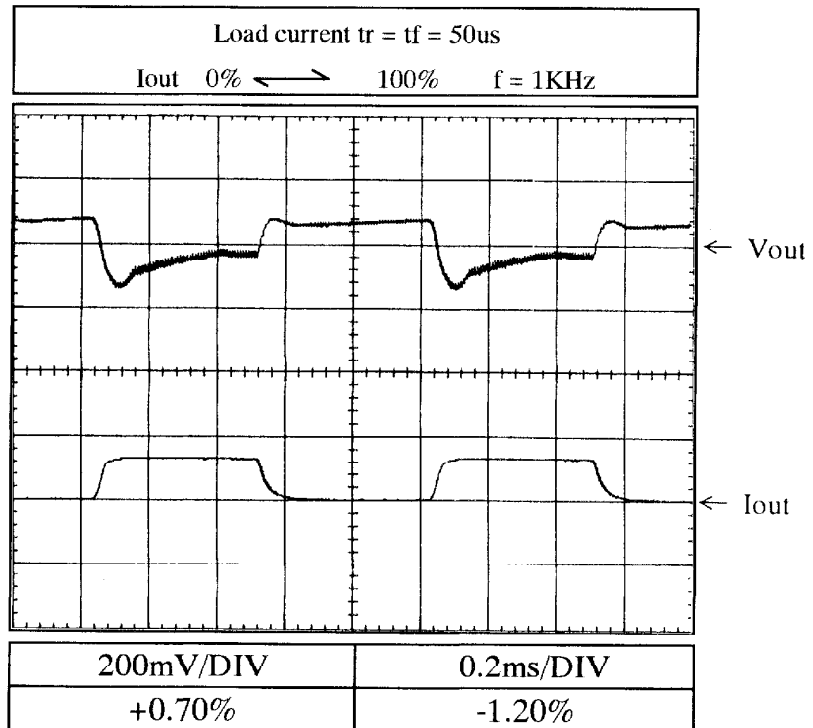
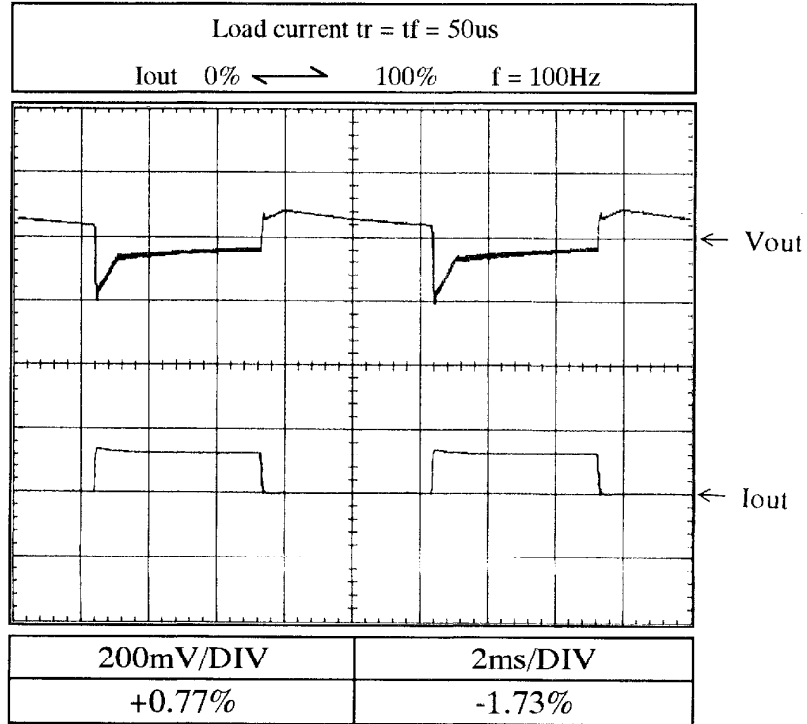

2.11 過渡応答 (負荷急変) 特性
Dynamic load response characteristics

Conditions Vin : 100VAC
Ta : 25°C

12V

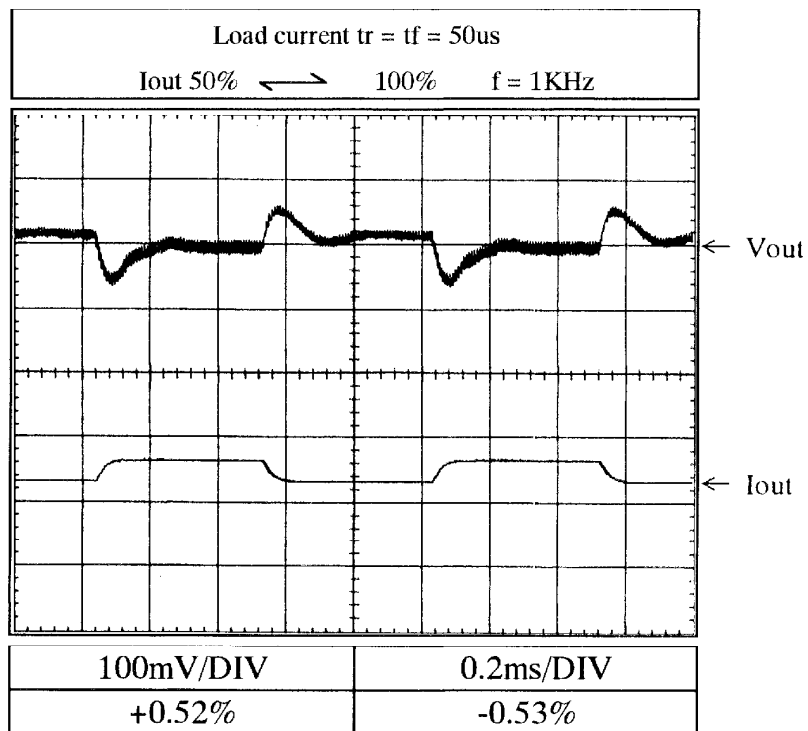
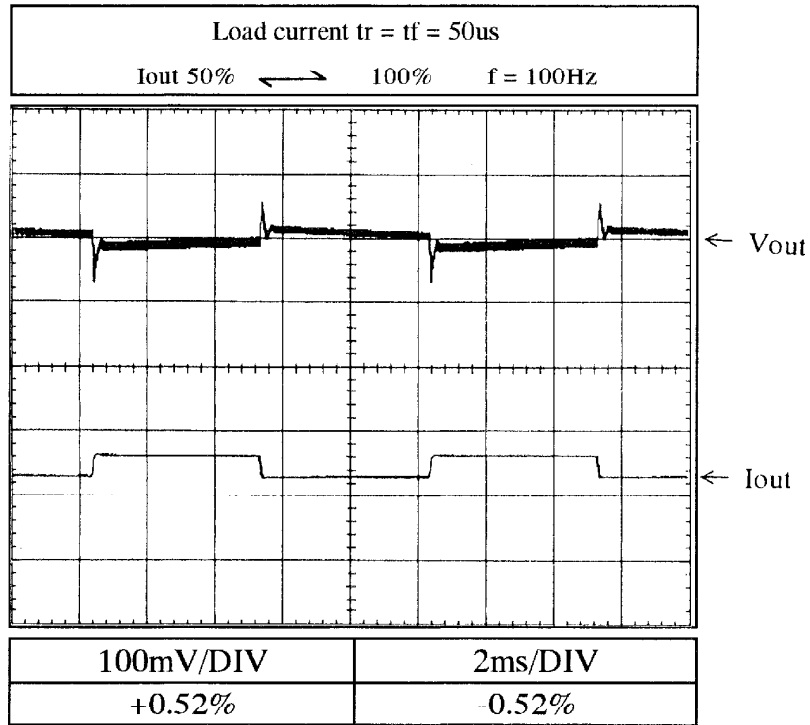

2.11 過渡応答（負荷急変）特性
Dynamic load response characteristics

Conditions Vin : 200VAC
Ta : 25°C

12V

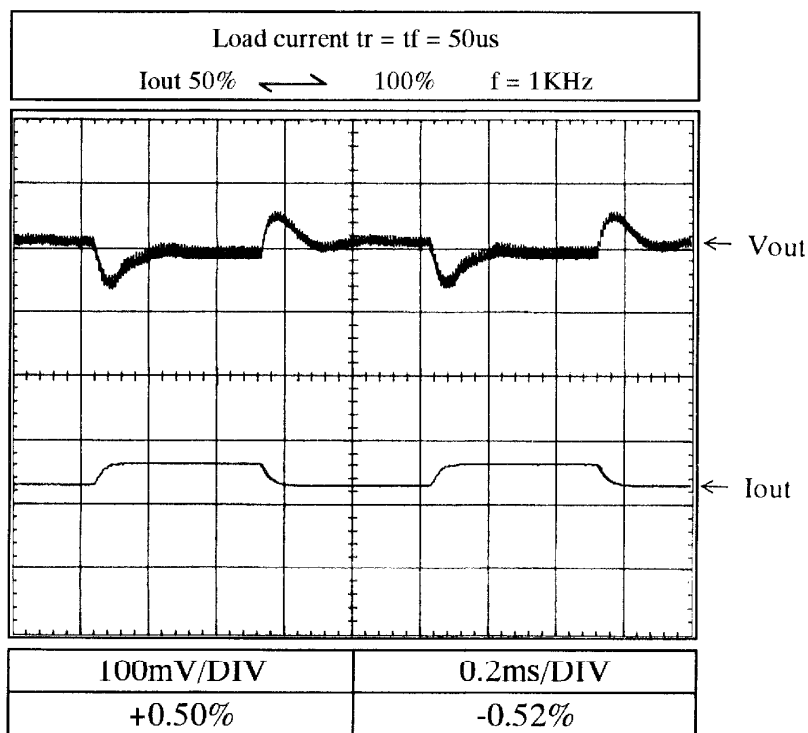
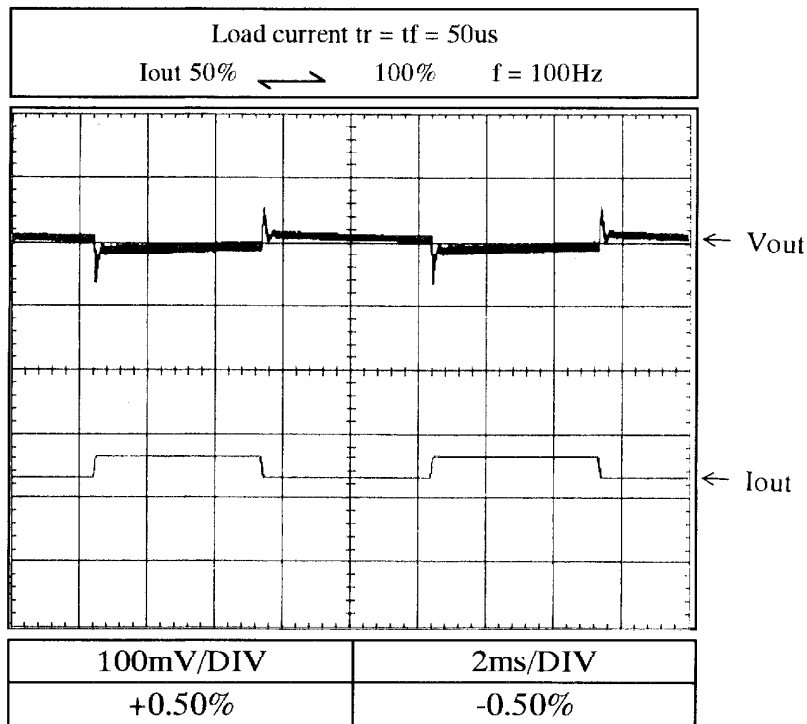

2.11 過渡応答 (負荷急変) 特性
Dynamic load response characteristics

Conditions Vin : 100VAC
Ta : 25°C

24V

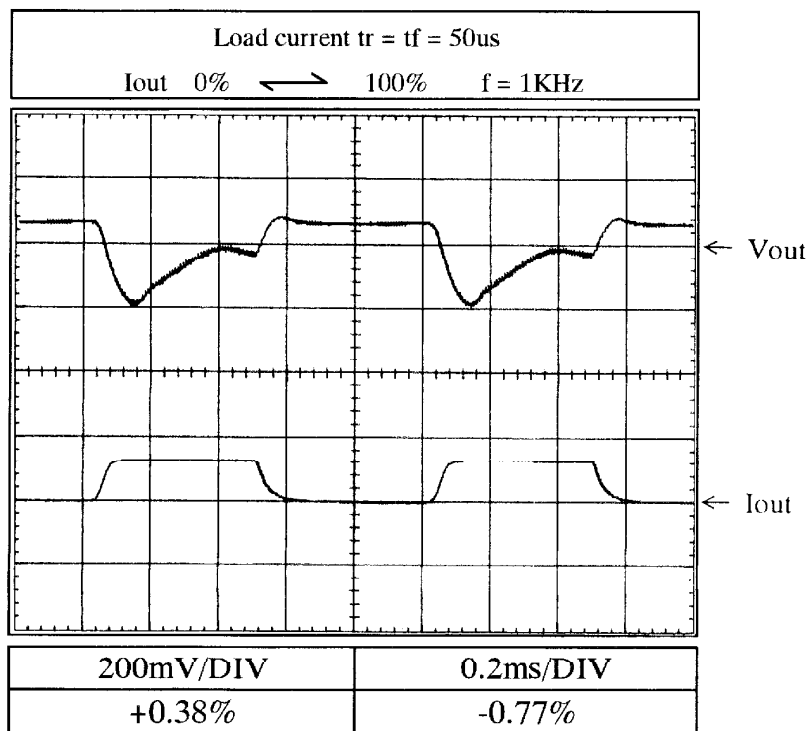
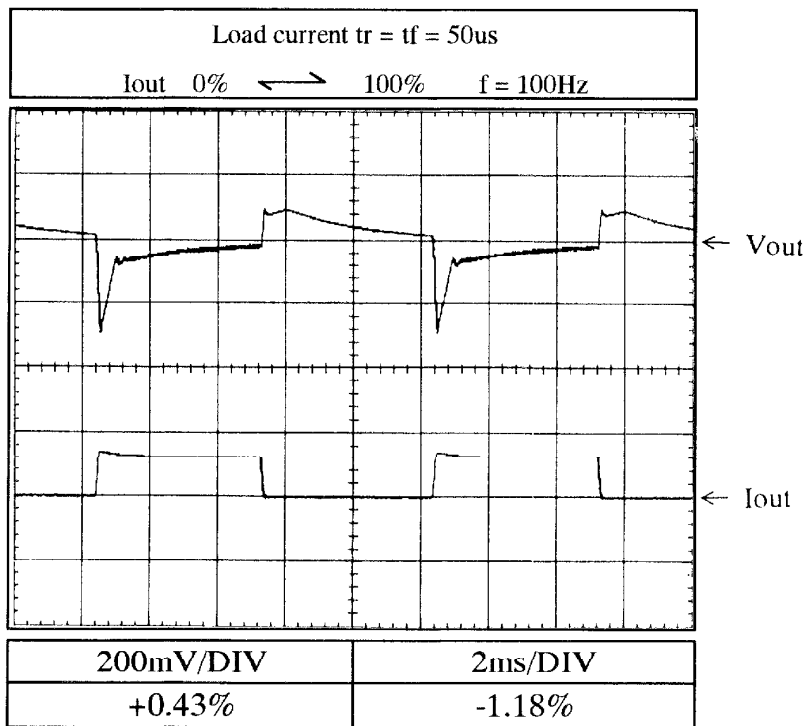

2.11 過渡応答 (負荷急変) 特性
Dynamic load response characteristics

Conditions Vin : 200VAC
Ta : 25°C

24V

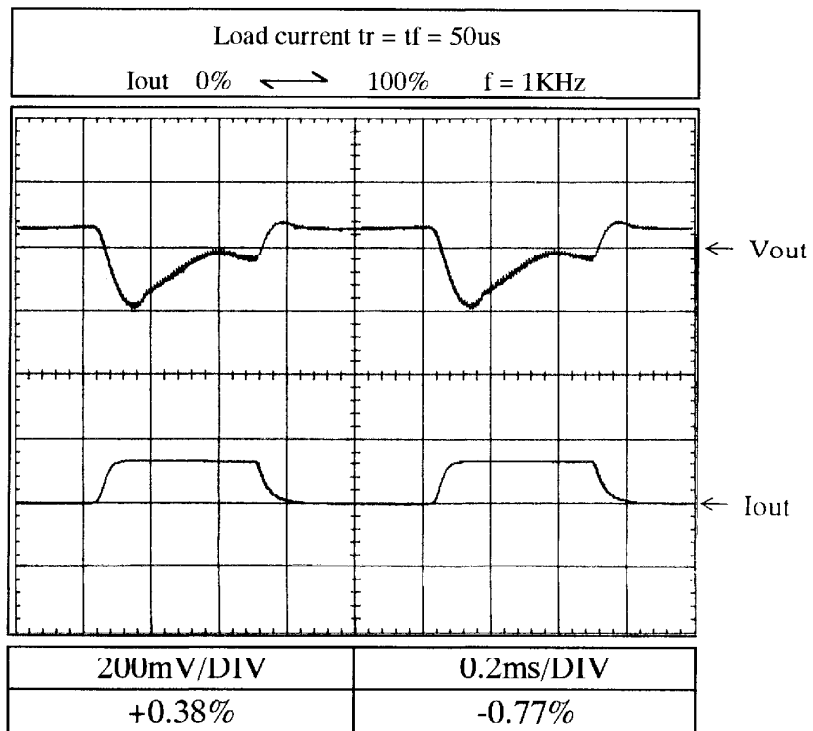
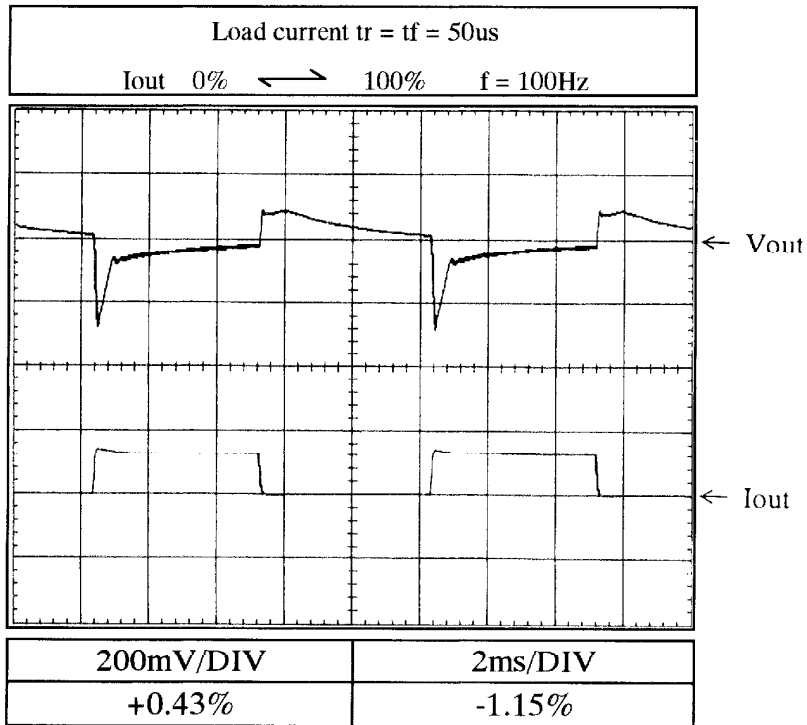

2.11 過渡応答 (負荷急変) 特性
Dynamic load response characteristics

Conditions Vin : 100VAC
Ta : 25°C

24V

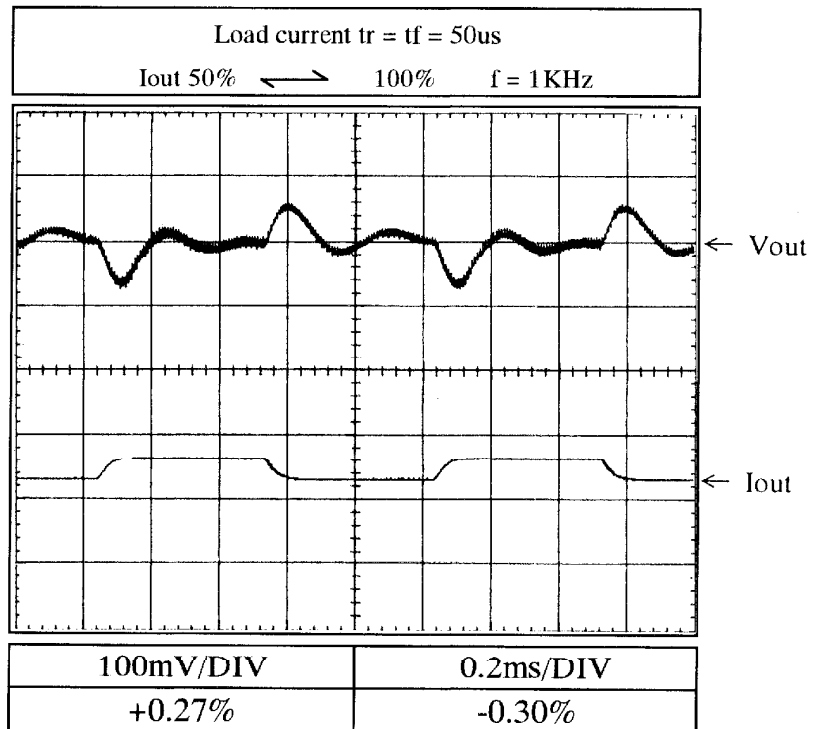
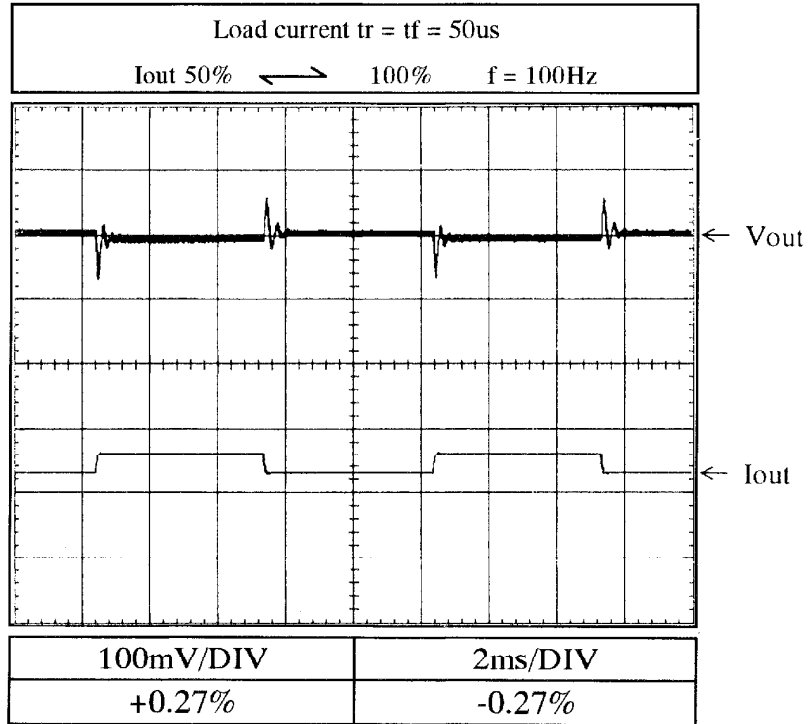

2.11 過渡応答 (負荷急変) 特性
Dynamic load response characteristics

Conditions Vin : 200VAC
Ta : 25°C

24V

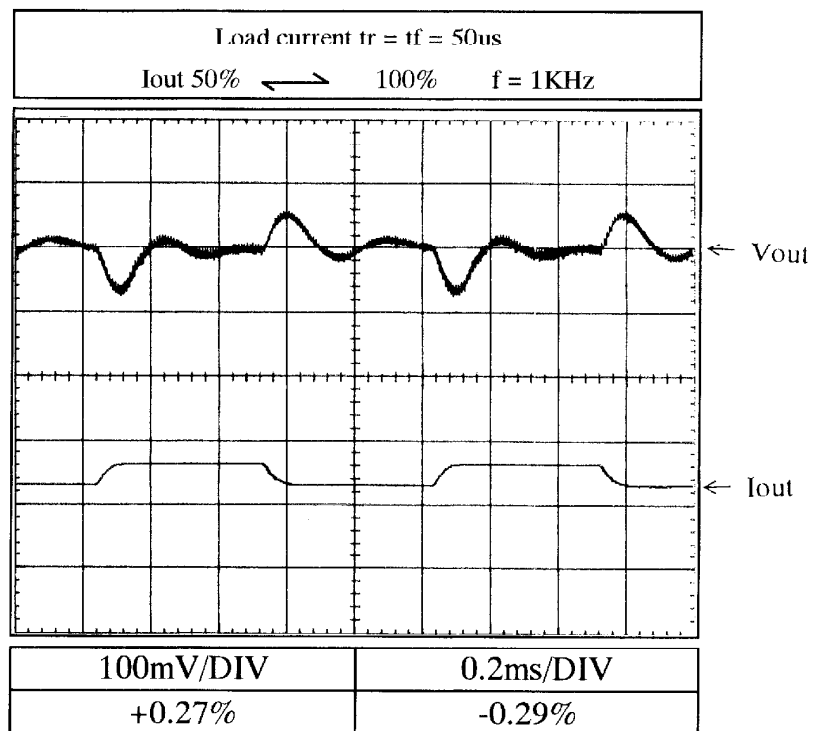
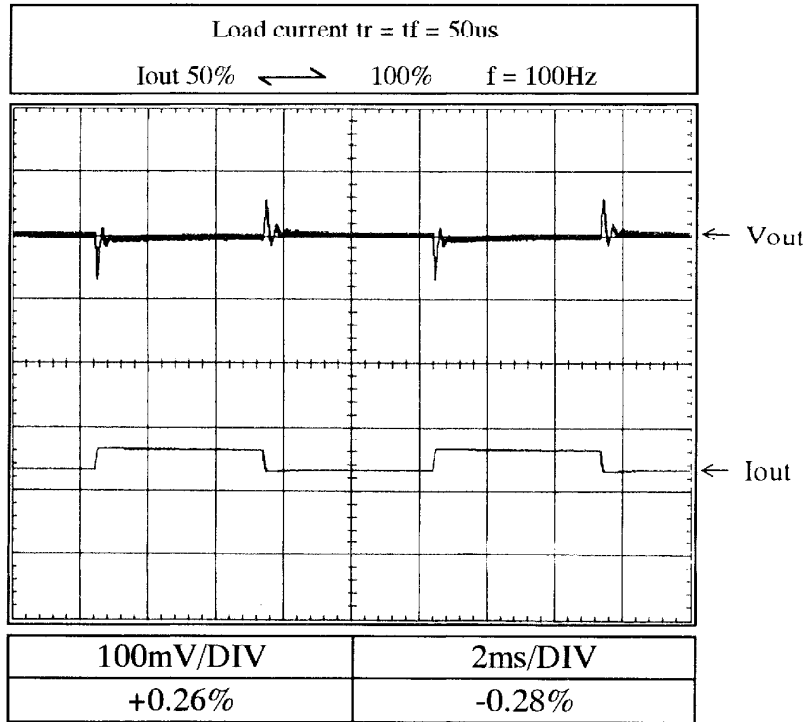

2.12 入力電圧瞬停特性
Response to brown out characteristics

Conditions V_{in} : 100VAC
 I_{out} : 100%
 T_a : 25°C

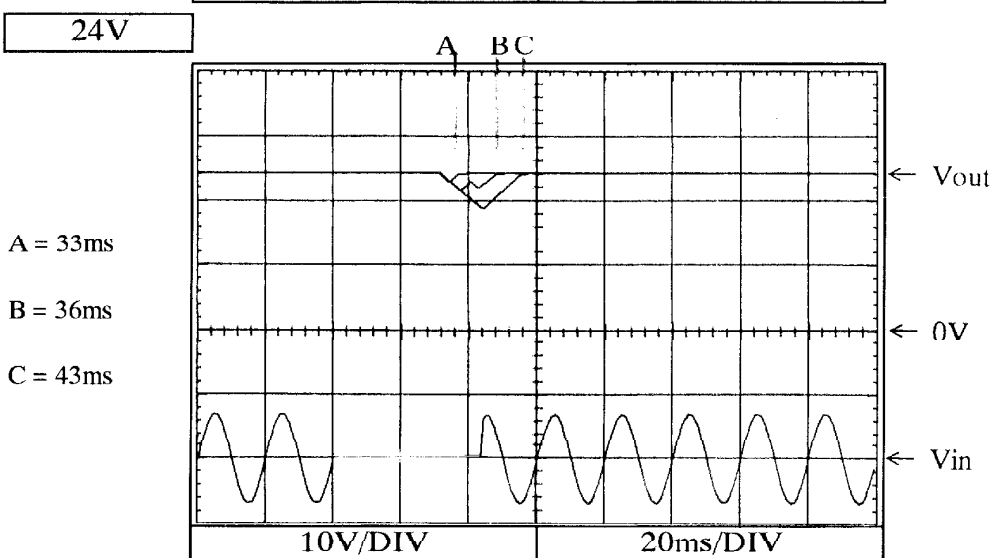
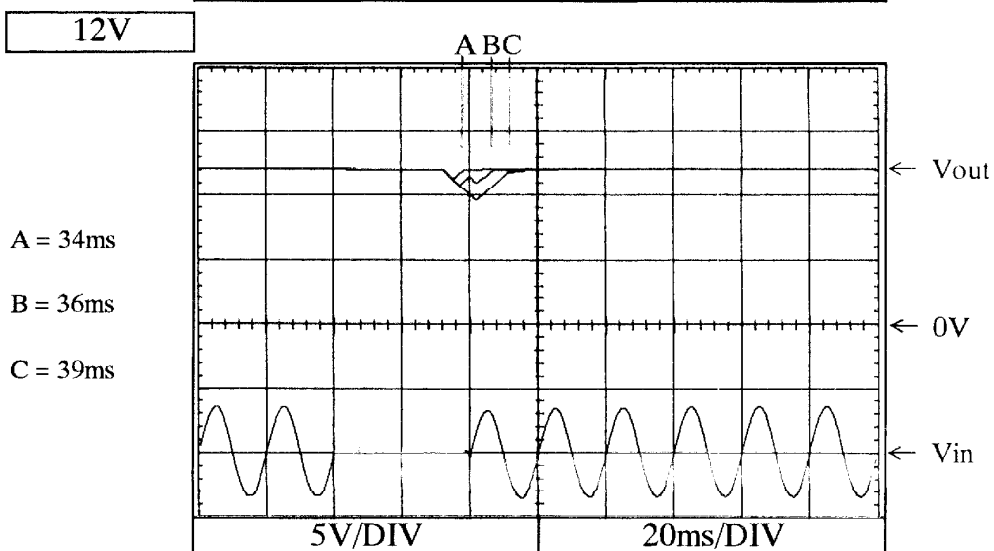
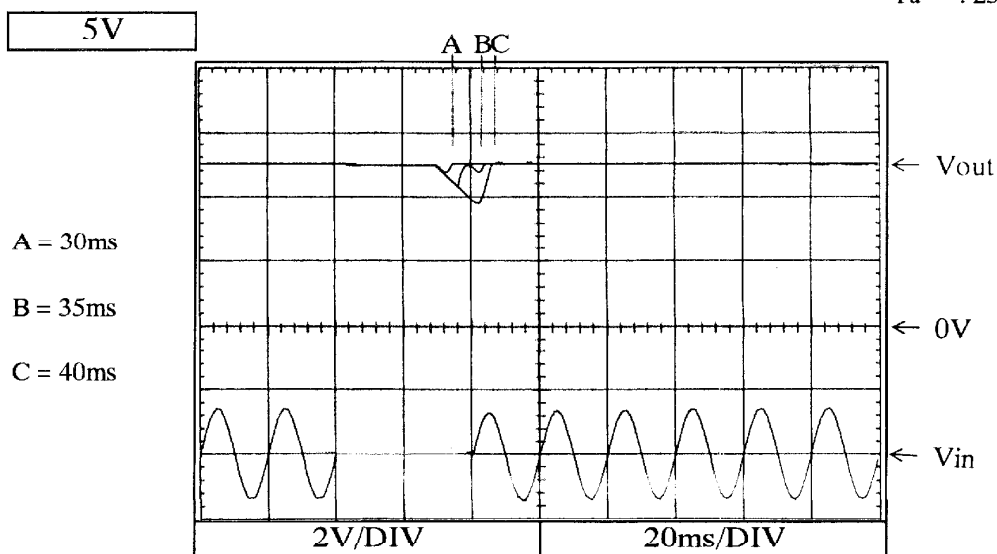

2.12 入力電圧瞬停特性
Response to brown out characteristics

Conditions Vin : 200VAC
Iout : 100%
Ta : 25°C

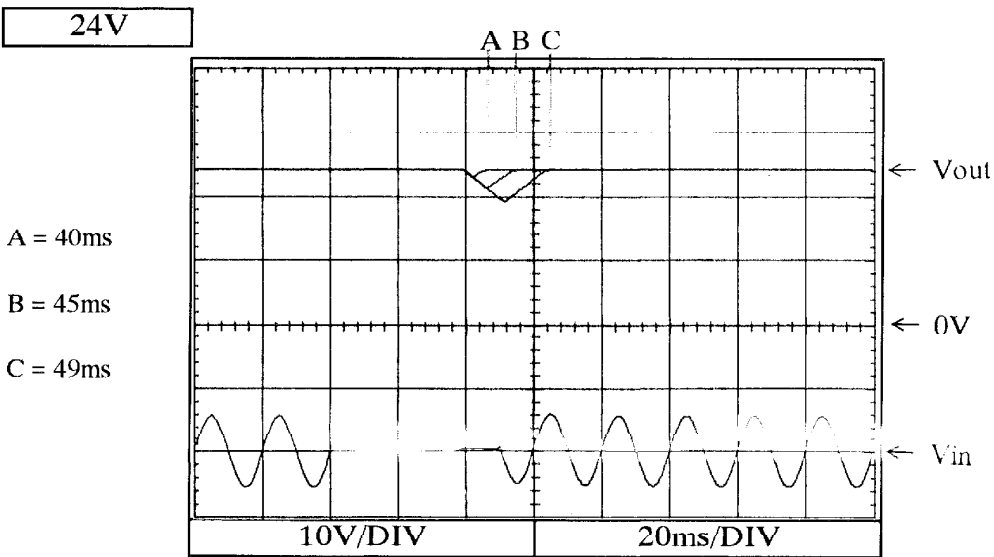
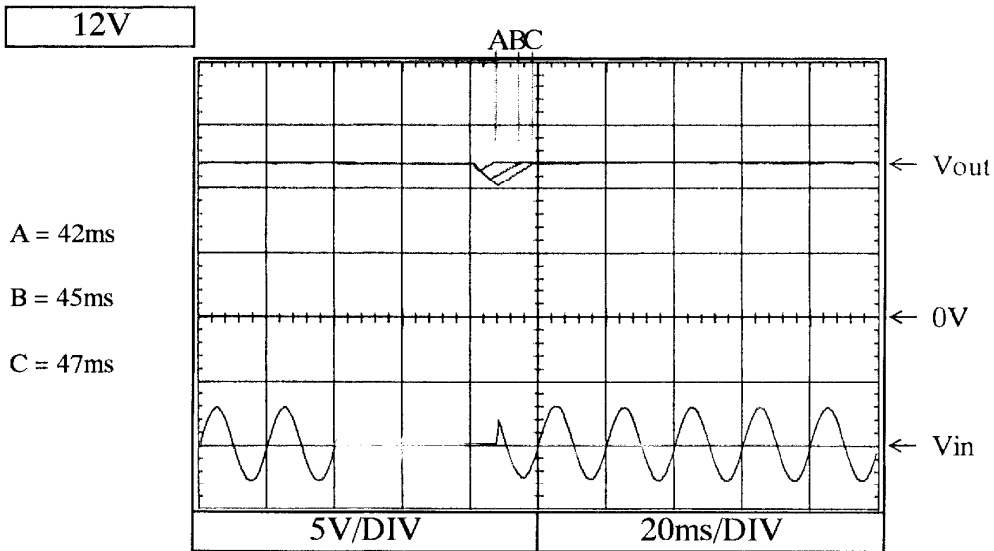
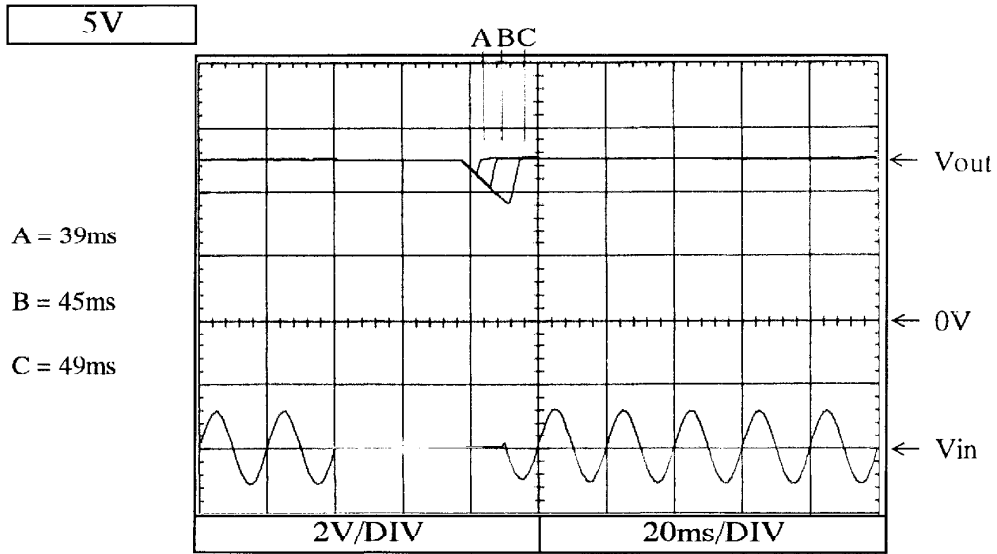

2.13 入力サージ電流 (突入電流) 特性
Inrush current waveform

Conditions Vin : 100VAC
Iout : 100%
Ta : 25°C

5V

Switch on phase angle
of input AC voltage
 $\phi = 0^\circ$

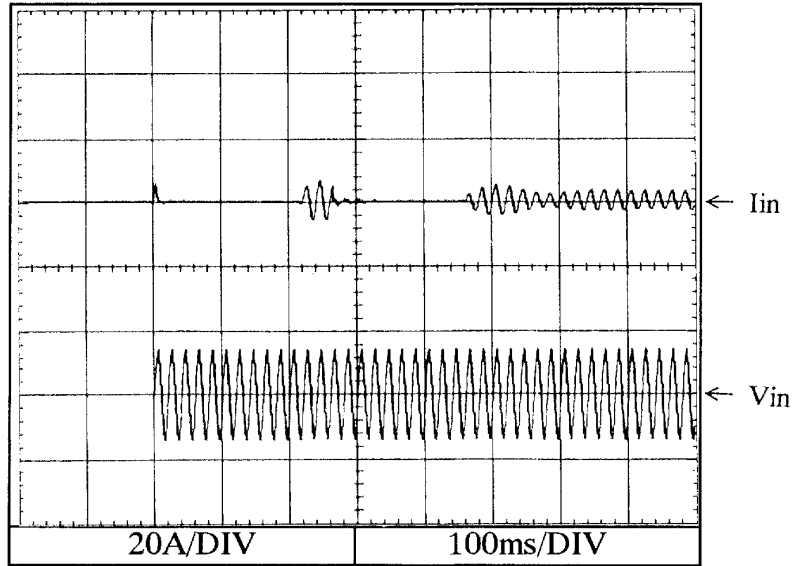

Switch on phase angle
of input AC voltage
 $\phi = 90^\circ$

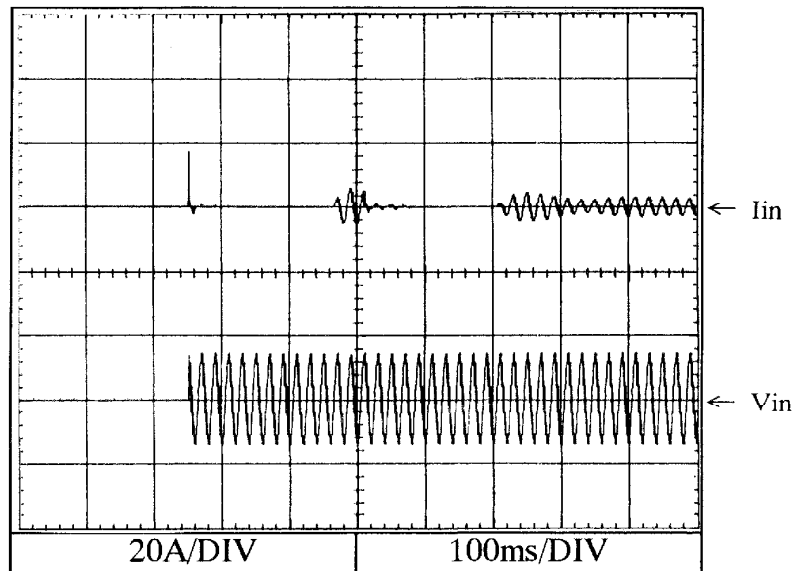

2.13 入力サージ電流 (突入電流) 特性
Inrush current waveform

Conditions Vin : 200VAC
Iout : 100%
Ta : 25°C

5V

Switch on phase angle
of input AC voltage
 $\phi = 0^\circ$

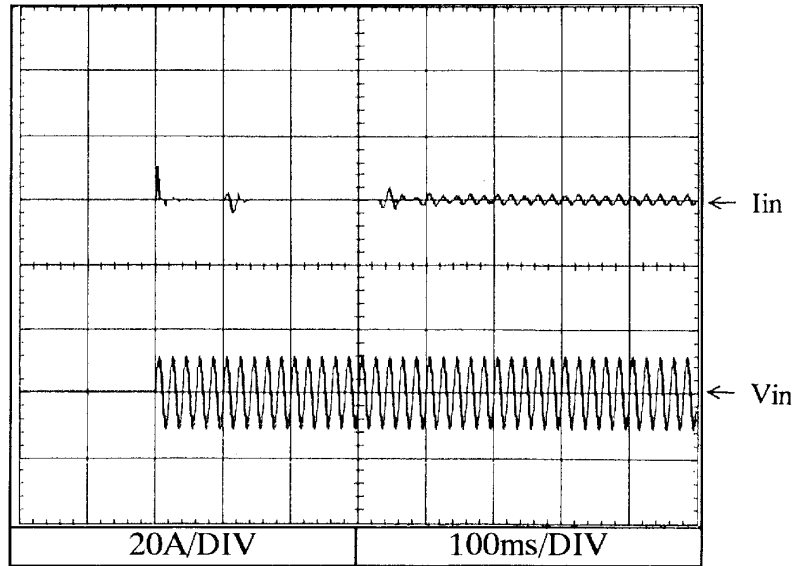

Switch on phase angle
of input AC voltage
 $\phi = 90^\circ$

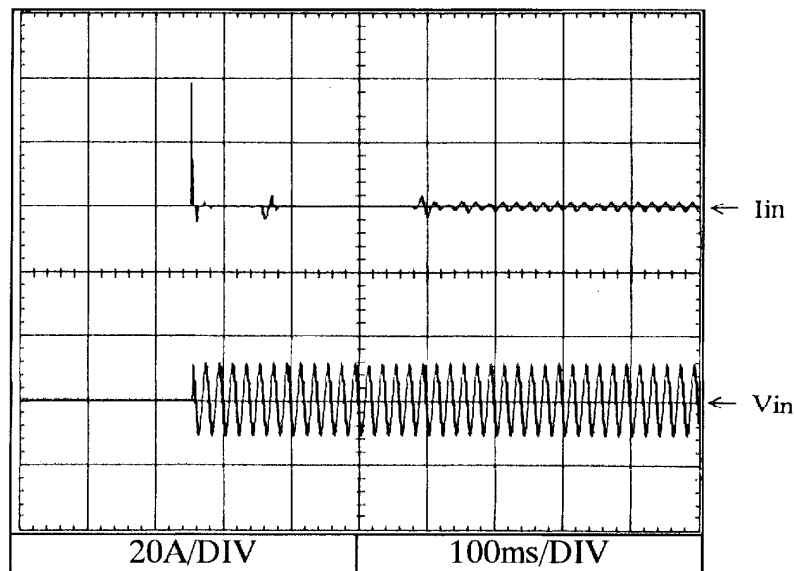

2.14 瞬停時突入電流特性

Inrush current characteristics

Conditions V_{in} : 100VAC

I_{out} : 0% - - - - -

: 50% - - -

: 100% ———

T_a : 25°C

5V

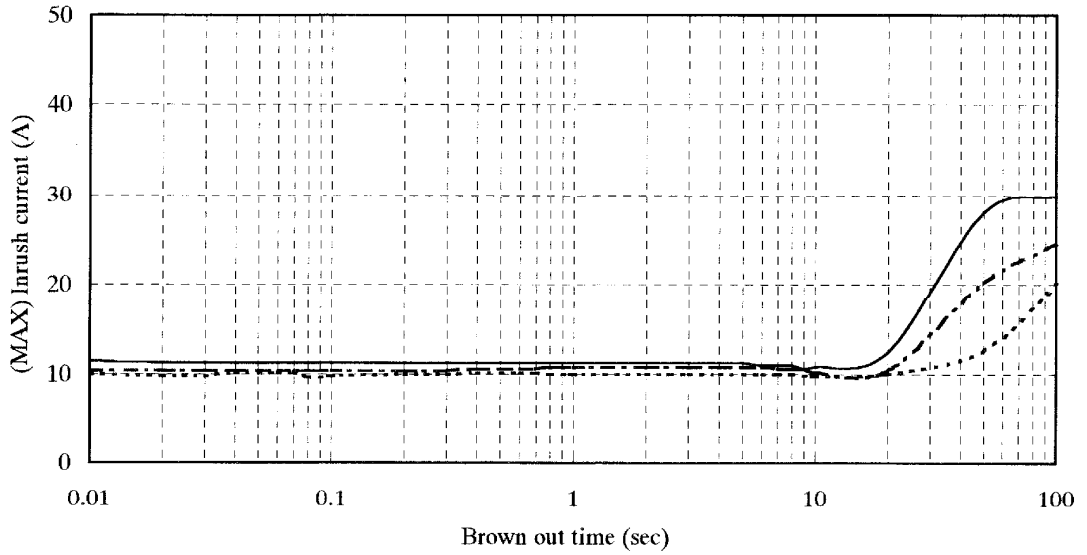

2.14 瞬停時突入電流特性

Inrush current characteristics

Conditions V_{in} : 200VAC

I_{out} : 0% - - - - -

: 50% - - -

: 100% ———

T_a : 25°C

5V

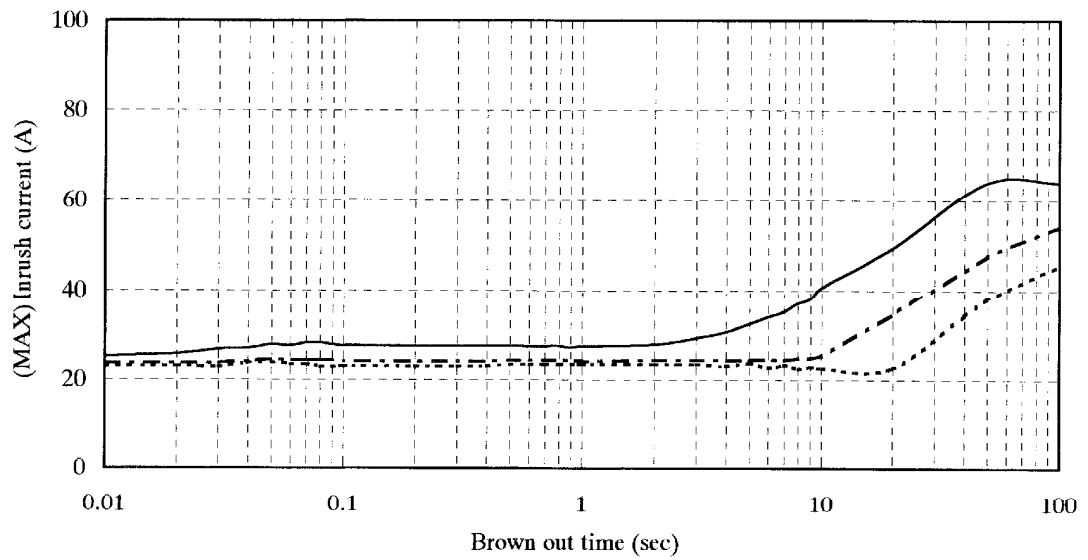

2.15 入力電流波形
Input current waveform

5V

Conditions Vin : 100VAC
Iout : 100%
Ta : 25°C

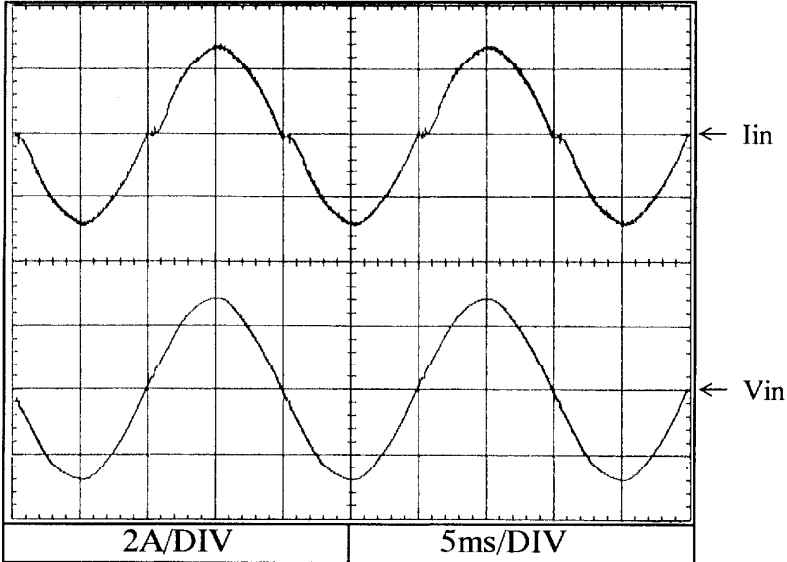

Conditions Vin : 200VAC
Iout : 100%
Ta : 25°C

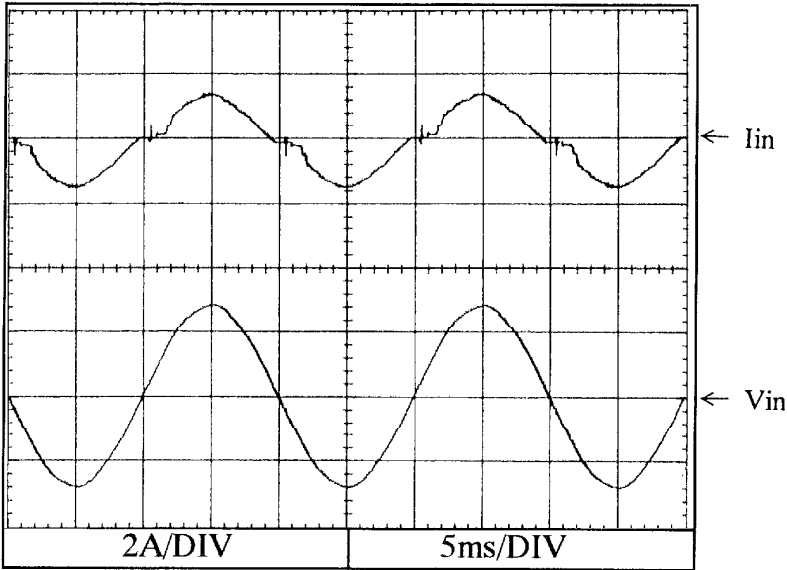

2.16 高調波成分
Input current harmonics

5V

Conditions Vin : 100VAC
Iout : 100%
Ta : 25°C

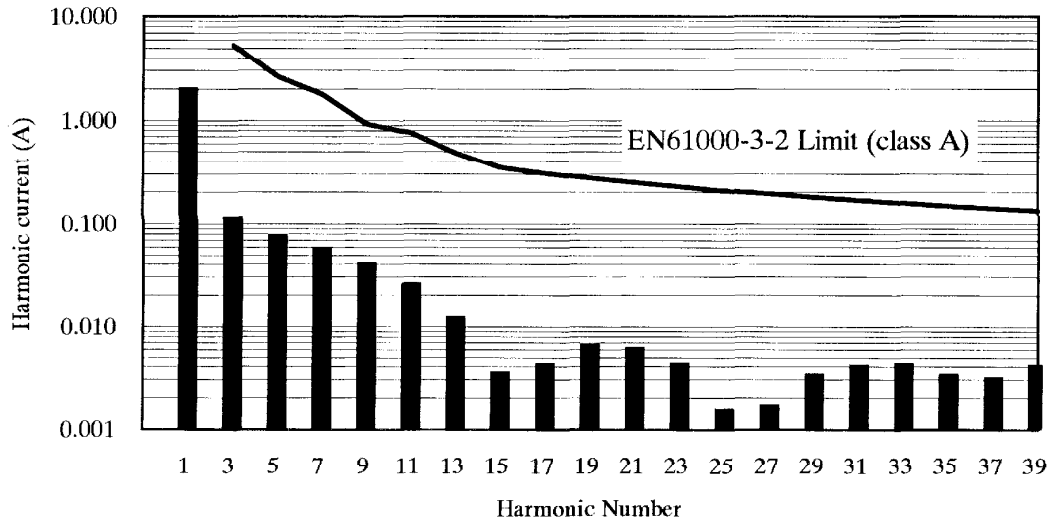

Conditions Vin : 230VAC
Iout : 100%
Ta : 25°C

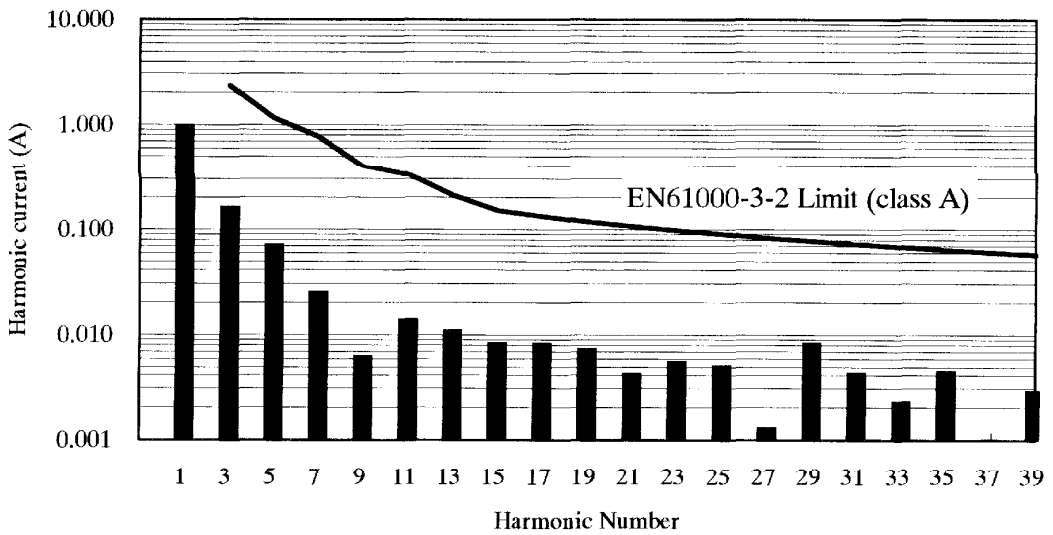

2.17 リーク電流特性

Leakage current characteristics

Conditions Iout : 0%
 : 100% ———
 Ta : 25°C
 f : 50Hz

Equipment used : MODEL 229-2 (Simpson)

5V

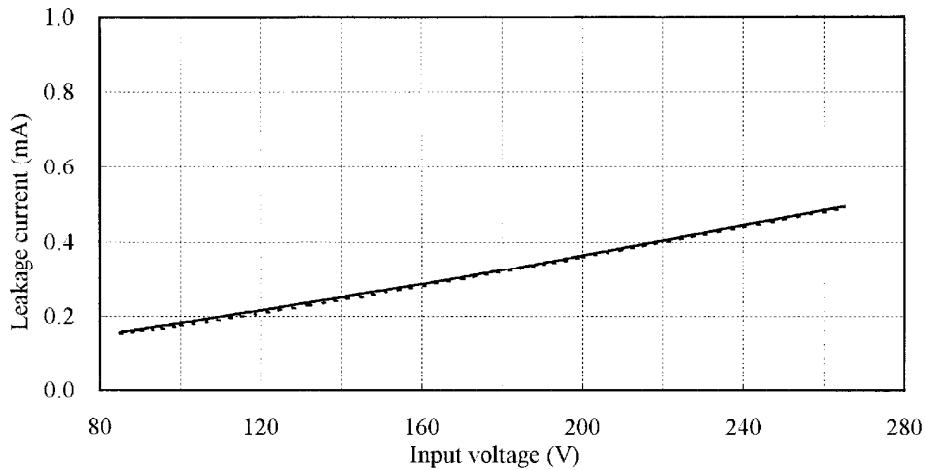

12V

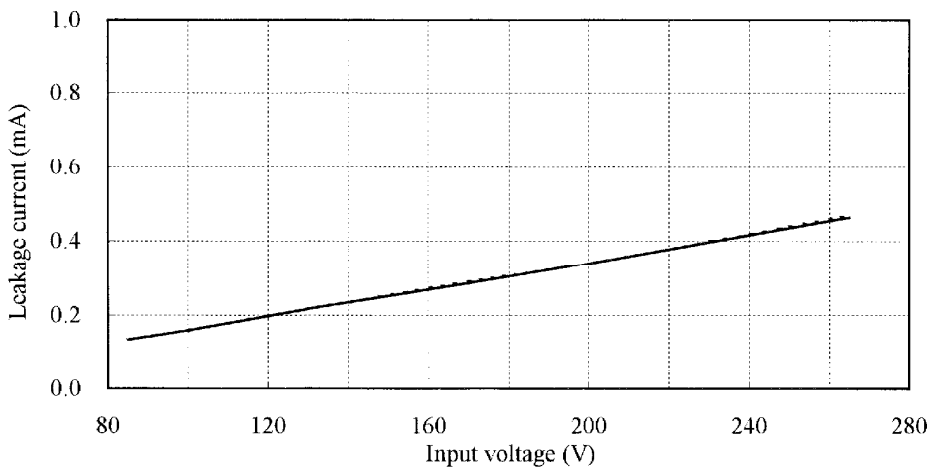

24V

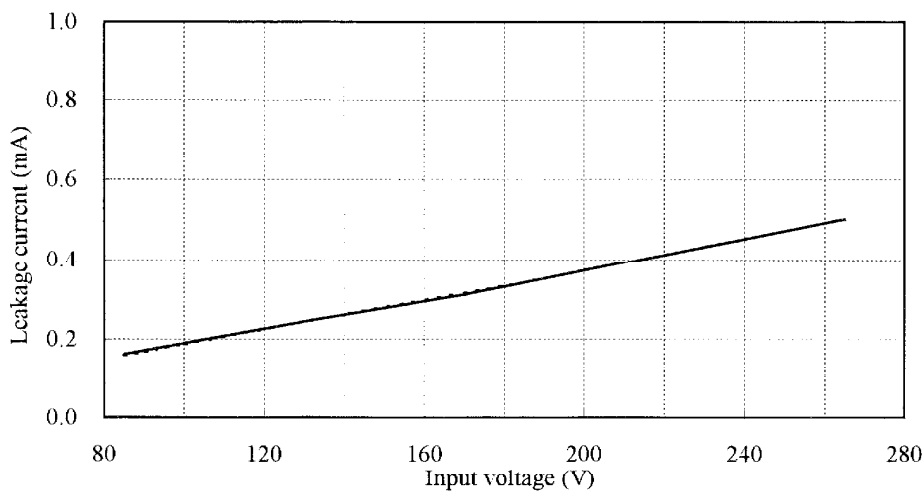

2.17 リーク電流特性
Leakage current characteristics

Conditions Iout : 0% -----
 : 100% —————
 Ta : 25°C
 f : 50Hz

Equipment used : TYPE3226 (YOKOGAWA)

5V

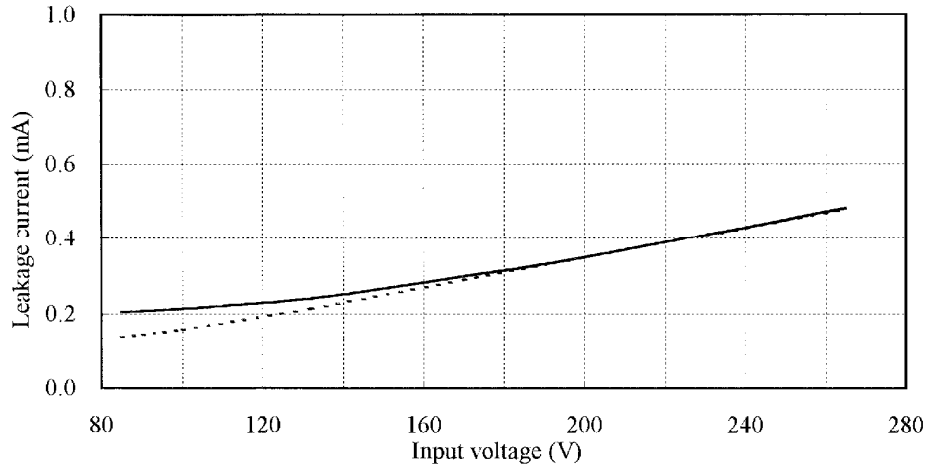

12V

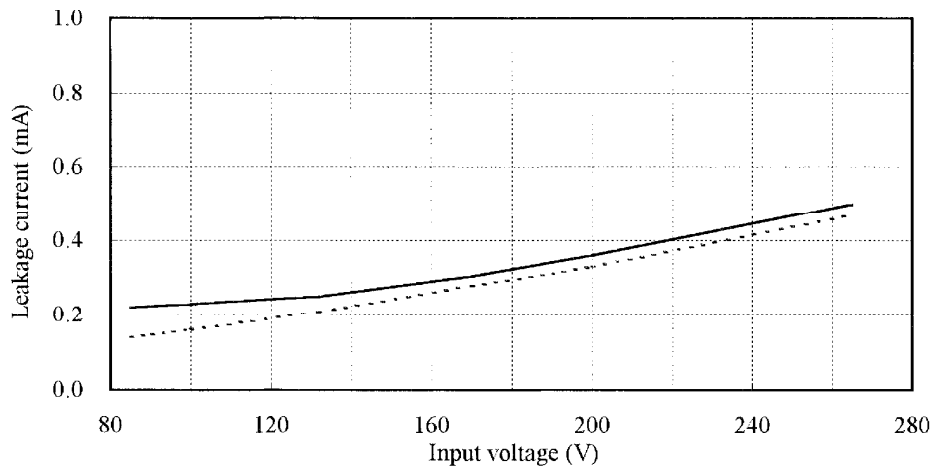

24V

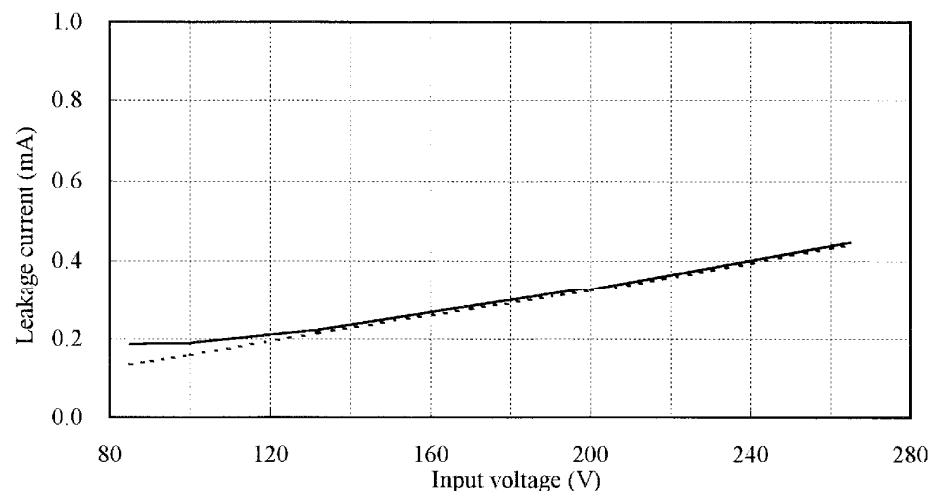

2.18 出力リップル、ノイズ波形
Output ripple and noise waveform
NORMAL MODE

Conditions Vin : 100VAC
Iout : 100%
Ta : 25°C

5V

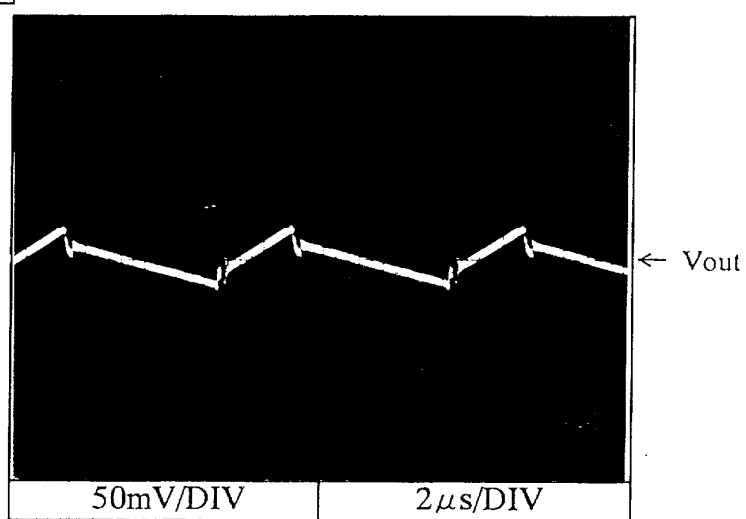

12V

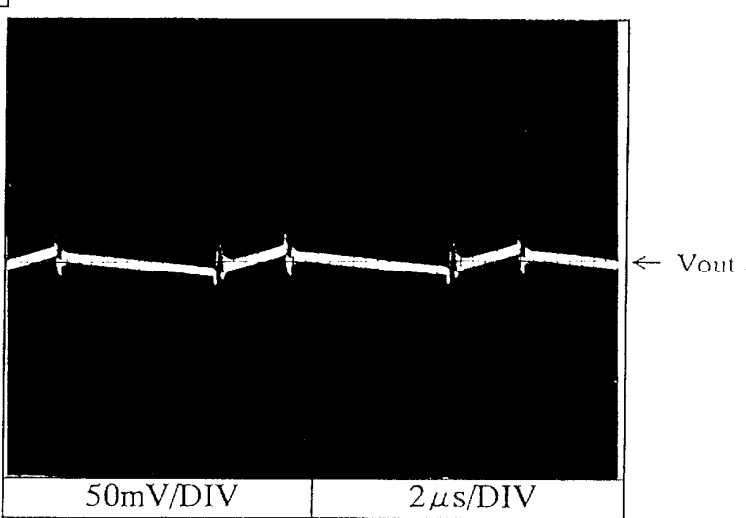

24V

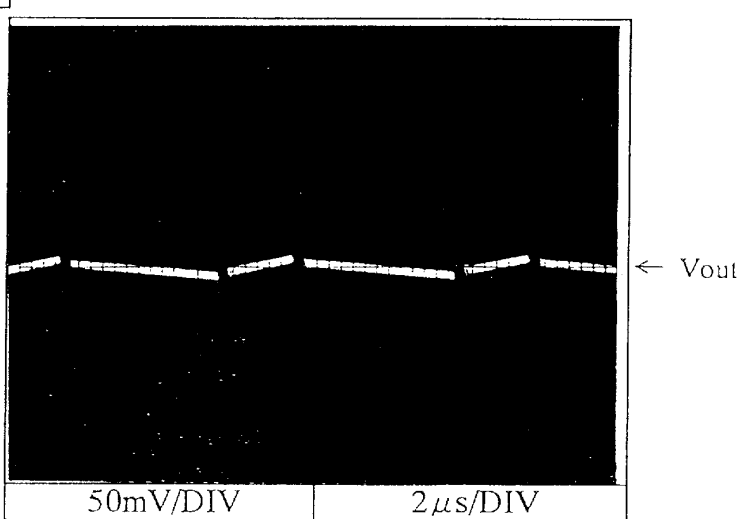

2.18 出力リップル、ノイズ波形

Output ripple and noise waveform

NORMAL MODE

Conditions Vin : 100VAC

Iout : 100%

Ta : 25°C

5V

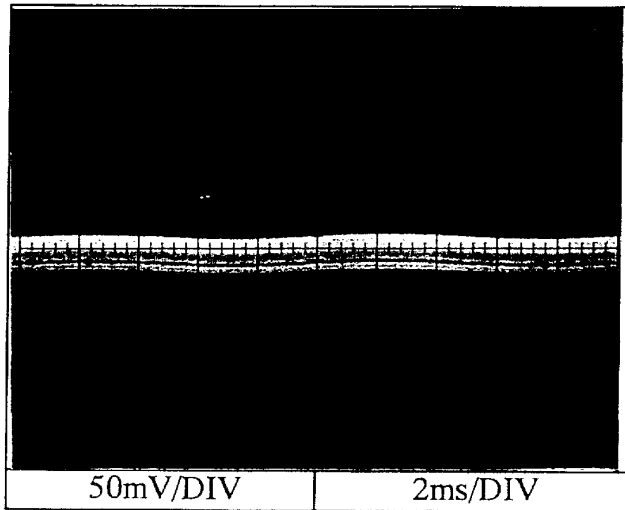

12V

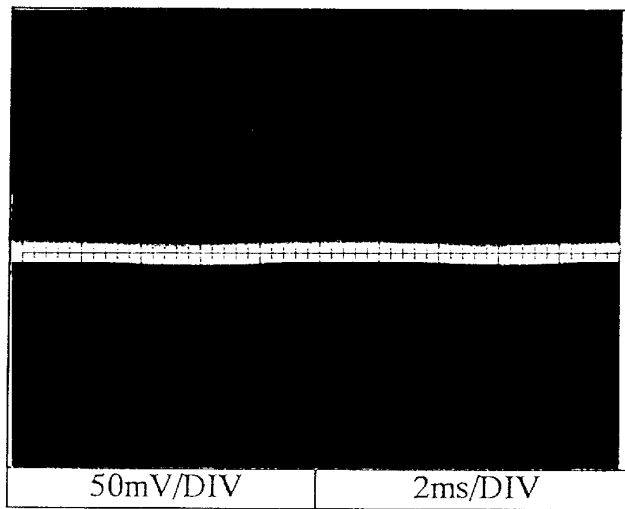

24V

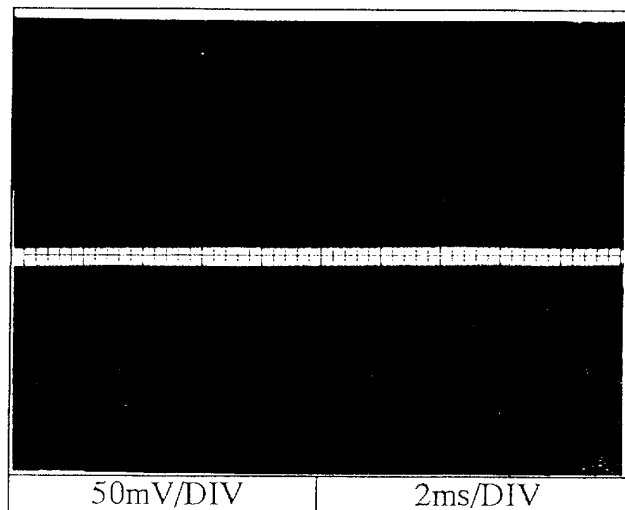

2.18 出力リップル、ノイズ波形
Output ripple and noise waveform
NORMAL MODE

Conditions Vin : 200VAC
Iout : 100%
Ta : 25°C

5V

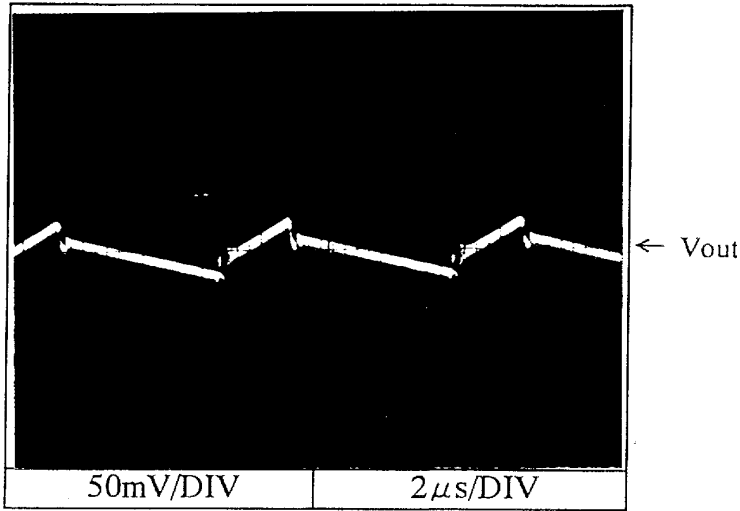

12V

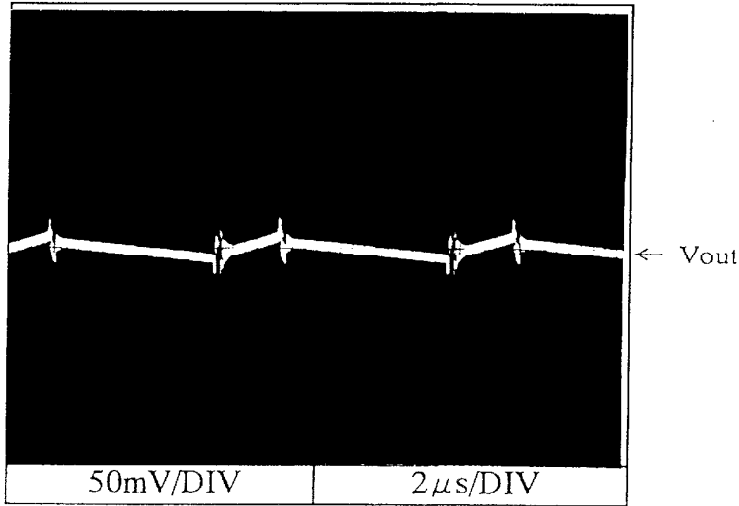

24V

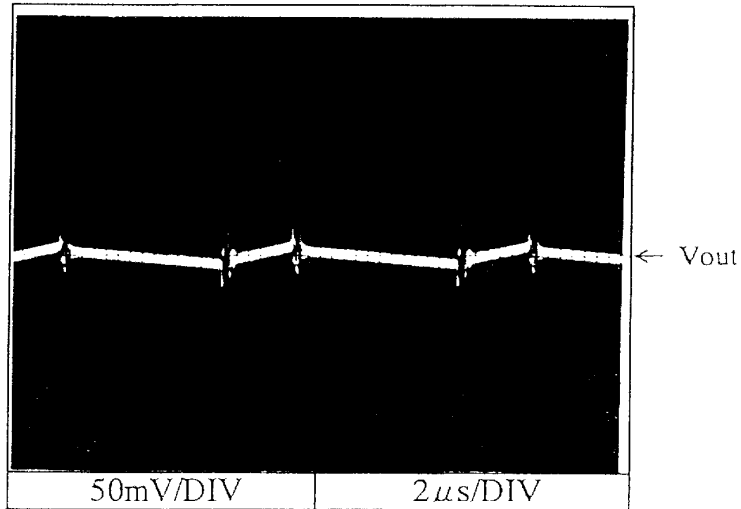

2.18 出力リップル、ノイズ波形
Output ripple and noise waveform
NORMAL MODE

Conditions Vin : 200VAC
Iout : 100%
Ta : 25°C

5V

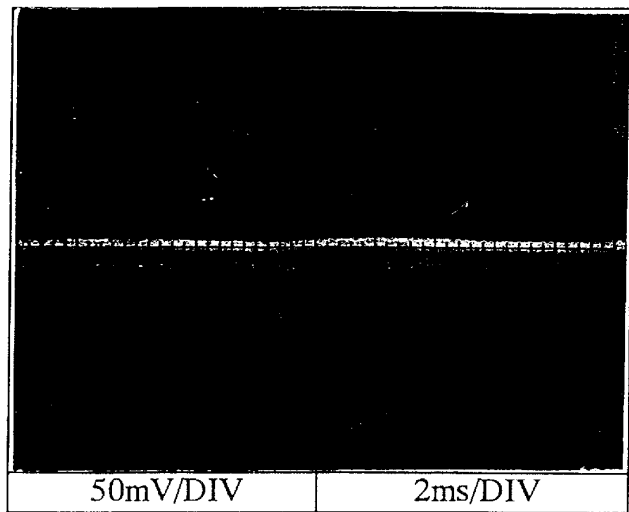

12V

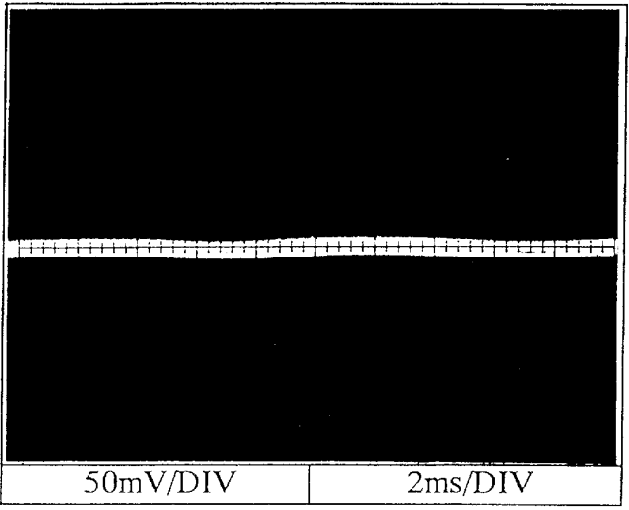

24V

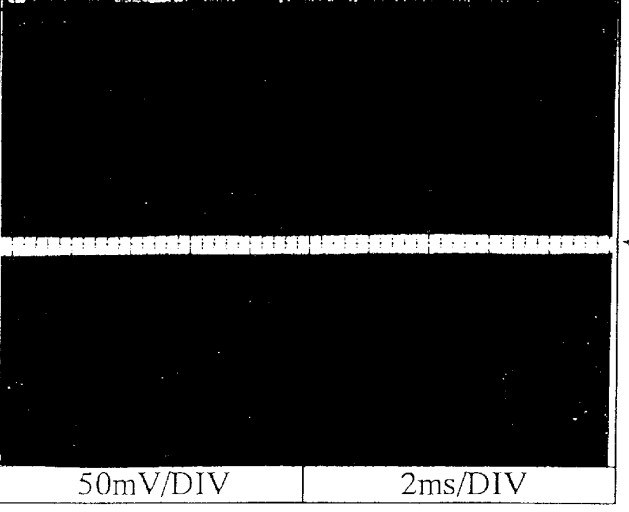

2.18 出力リップル、ノイズ波形

Output ripple and noise waveform

NORMAL + COMMON MODE

Conditions Vin : 100VAC

Iout : 100%

Ta : 25°C

5V

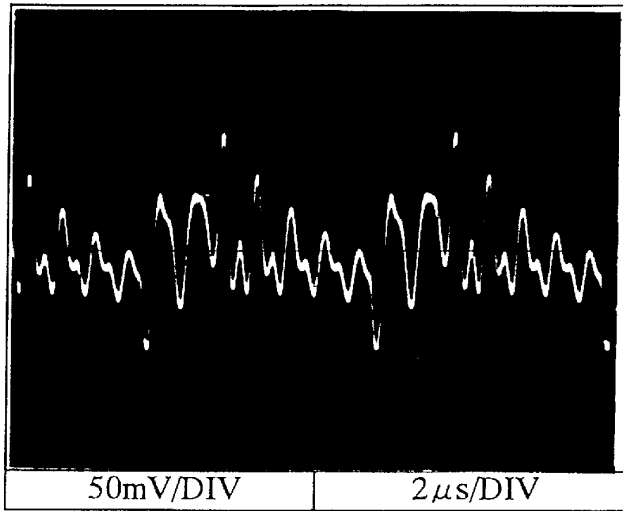

12V

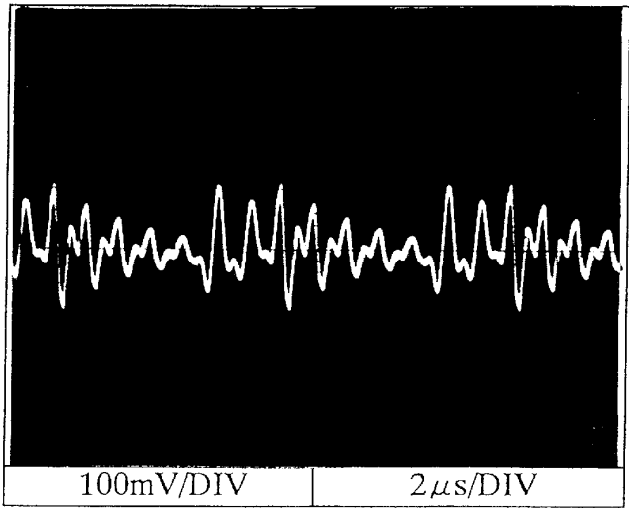

24V

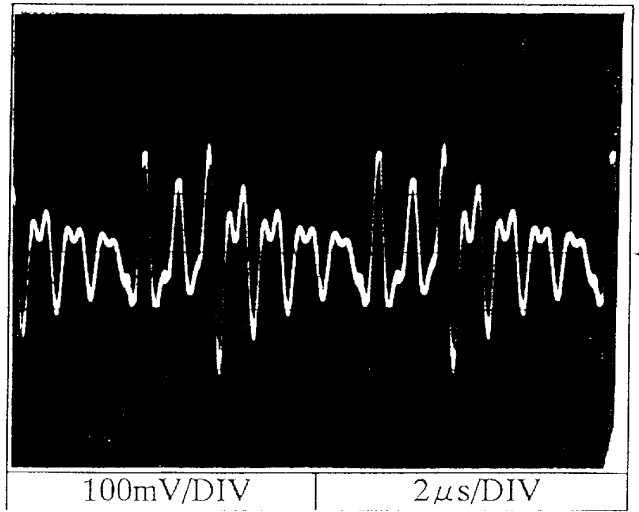

2.18 出力リップル、ノイズ波形

Output ripple and noise waveform

NORMAL + COMMON MODE

Conditions Vin : 100VAC

Iout : 100%

Ta : 25°C

5V

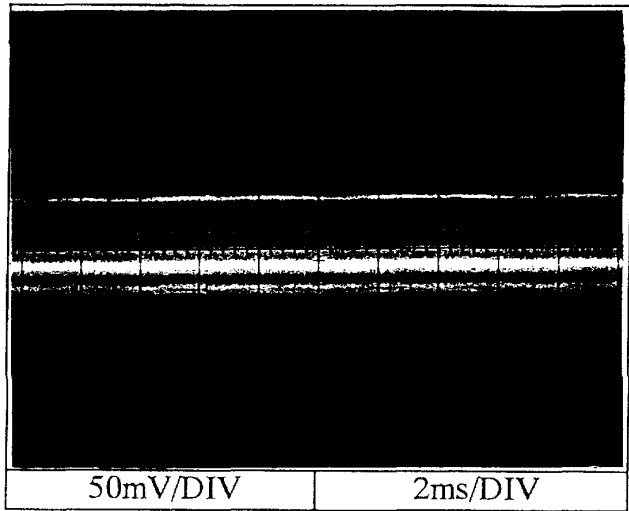

12V

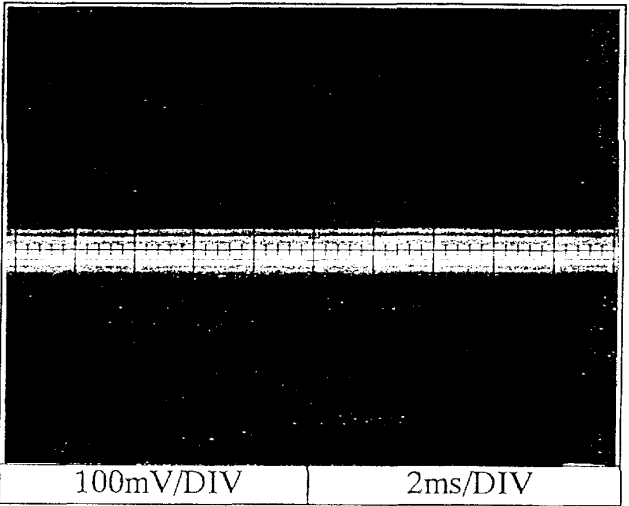

24V

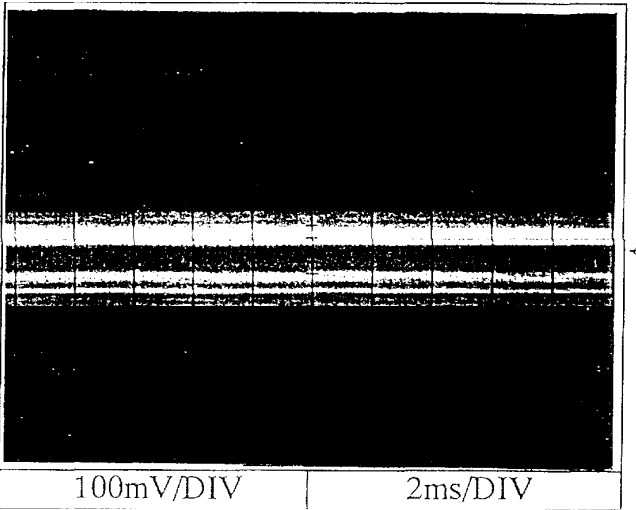

2.18 出力リップル、ノイズ波形

Output ripple and noise waveform

NORMAL + COMMON MODE

Conditions Vin : 200VAC

Iout : 100%

Ta : 25°C

5V

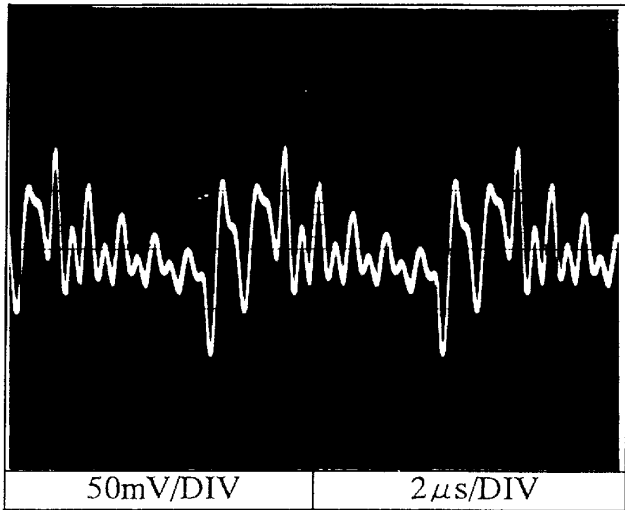

12V

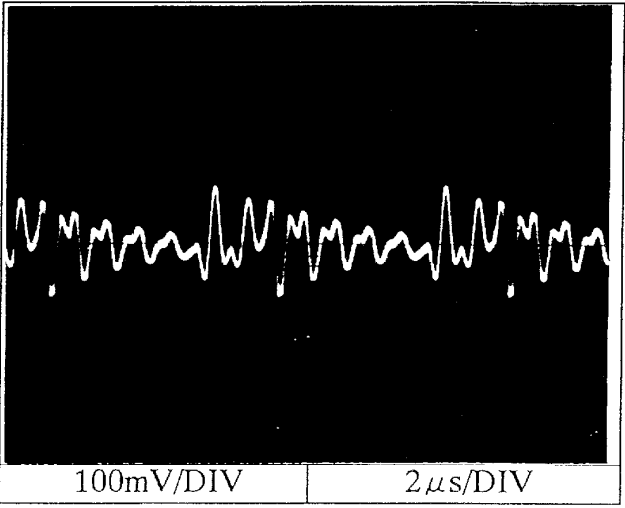

24V

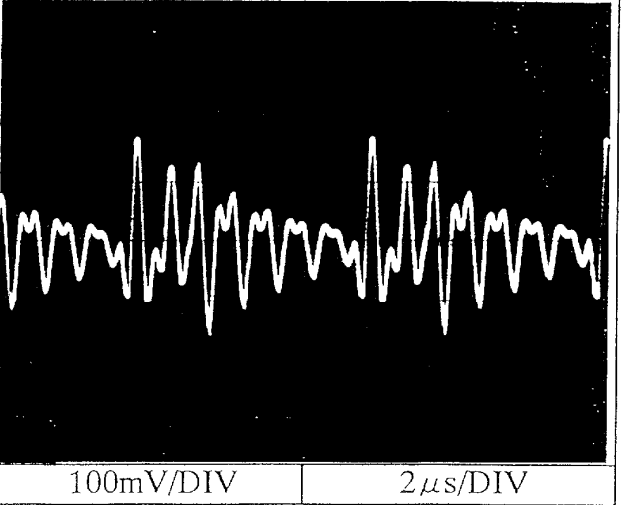

2.18 出力リップル、ノイズ波形

Output ripple and noise waveform

NORMAL + COMMON MODE

Conditions Vin : 200VAC

Iout : 100%

Ta : 25°C

5V

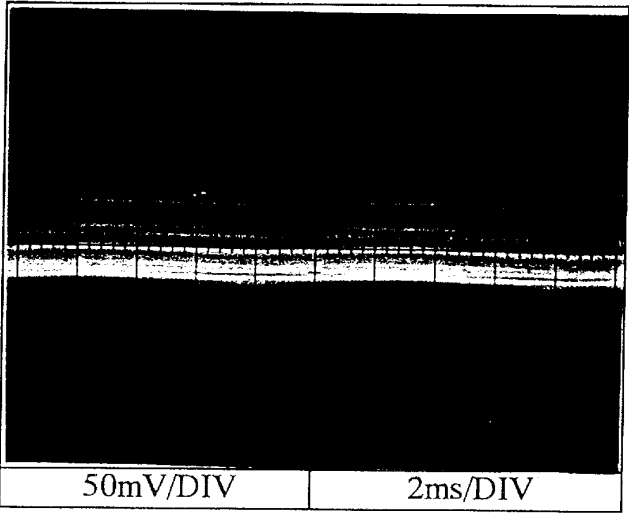

12V

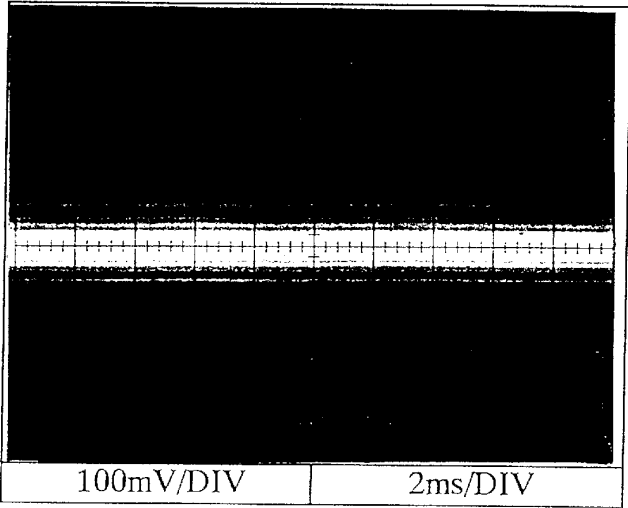

24V

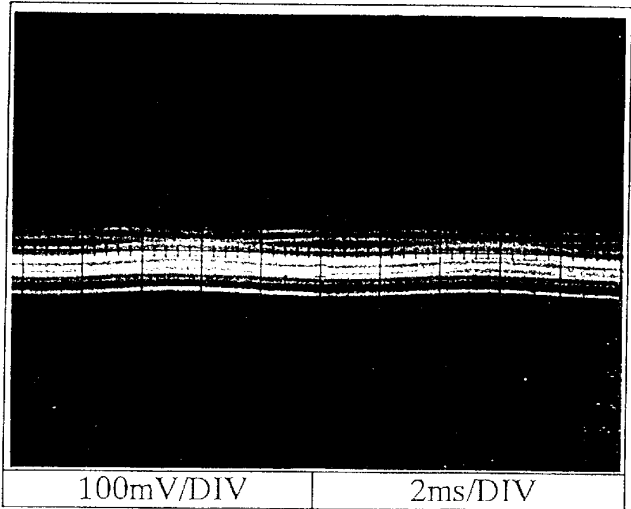

2.19 EMI 特性

Electro-Magnetic Interference characteristics

Conditions Vin : 100VAC

Iout : 100%

Phase : L

雑音端子電圧

Conducted Emission

5 V

Ref.	Point A (529.0 KHz)	
	Limit (dBuV)	Measure (dBuV)
QP	48.0	36.1
AV	46.0	35.8

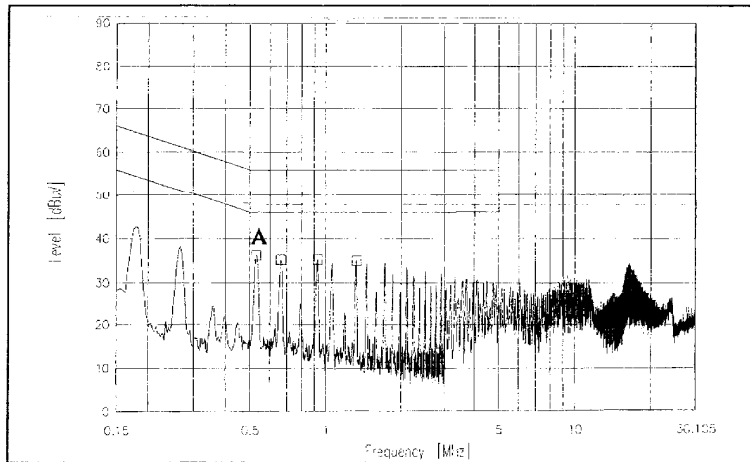

VCCI Class 2
QP Limit
VCCI Class 2
AV Limit
FCC Class B
QP Limit

12V

Ref.	Point B (16.202MHz)	
	Limit (dBuV)	Measure (dBuV)
QP	48.0	38.7
AV	50.0	37.8

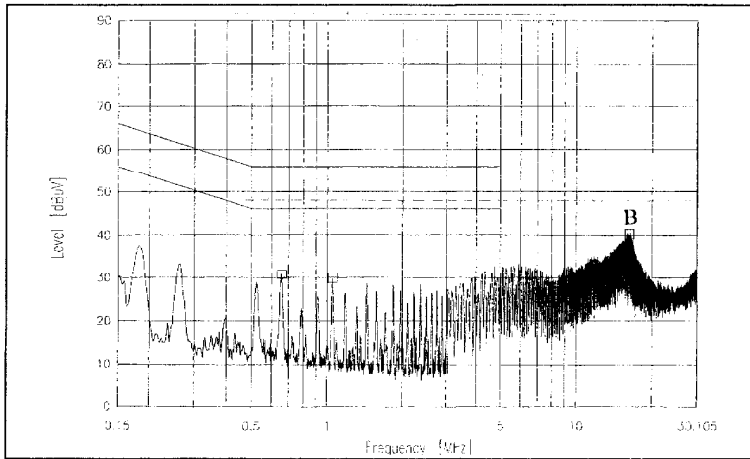

VCCI Class 2
QP Limit
VCCI Class 2
AV Limit
FCC Class B
QP Limit

24V

Ref.	Point C (182.0KHz)	
	Limit (dBuV)	Measure (dBuV)
QP	64.4	43.2
AV	54.4	40.2

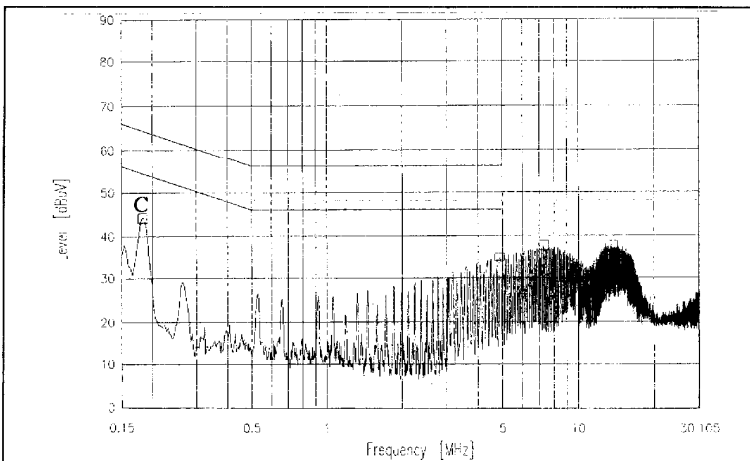

VCCI Class 2
QP Limit
VCCI Class 2
AV Limit
FCC Class B
QP Limit

EN55011-B,EN55022-Bの限度値はVCCI class Bの限度値と同じ
Limits of EN55011-B and EN55022-B are same as its VCCI class B.

2.19 EMI 特性

Electro-Magnetic Interference characteristics

Conditions Vin : 100VAC
Iout : 100%
Phase : N

雑音端子電圧

Conducted Emission

5 V

Ref.	Point A (528.0 KHz)	
	Limit (dBuV)	Measure (dBuV)
QP	48.0	34.4
AV	46.0	34.2

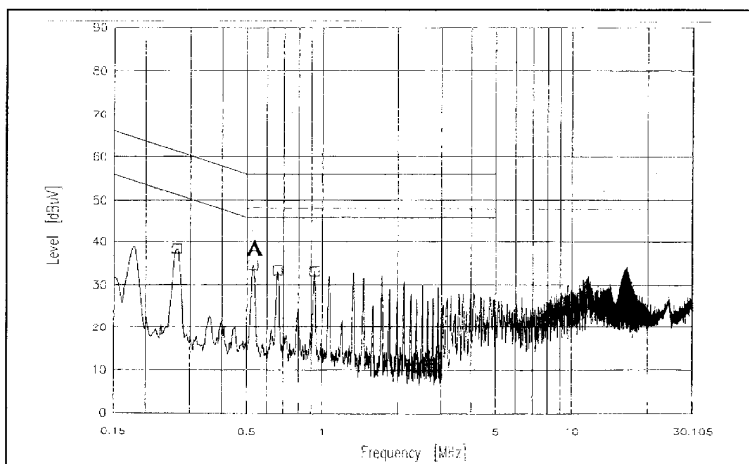

VCCI Class 2
QP Limit
VCCI Class 2
AV Limit
FCC Class B
QP Limit

12V

Ref.	Point B (16.087MHz)	
	Limit (dBuV)	Measure (dBuV)
QP	48.0	40.3
AV	50.0	35.5

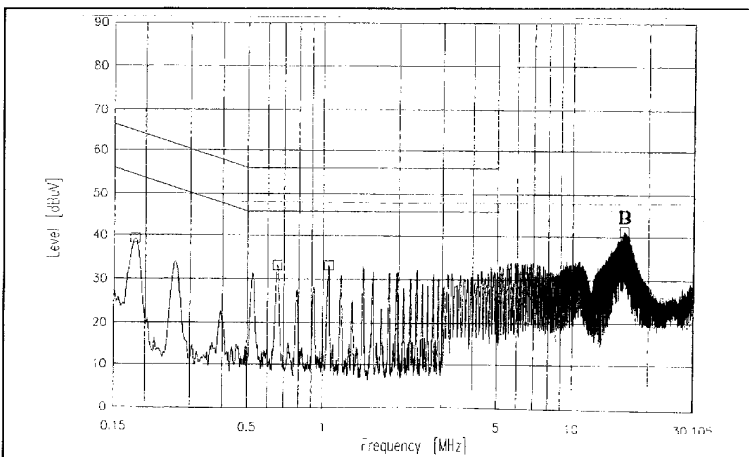

VCCI Class 2
QP Limit
VCCI Class 2
AV Limit
FCC Class B
QP Limit

24V

Ref.	Point C (8.024MHz)	
	Limit (dBuV)	Measure (dBuV)
QP	48.0	39.4
AV	50.0	38.0

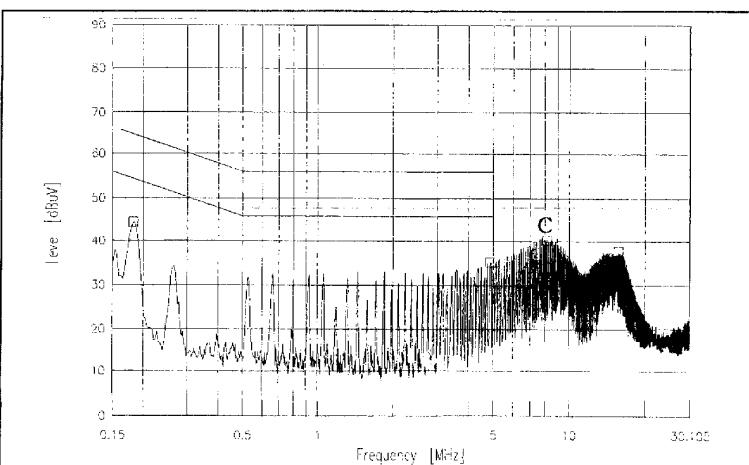

VCCI Class 2
QP Limit
VCCI Class 2
AV Limit
FCC Class B
QP Limit

EN55011-B, EN55022-Bの限度値はVCCI class Bの限度値と同じ
Limits of EN55011-B and EN55022-B are same as its VCCI class B.

2.19 EMI特性
Electro-Magnetic Interference characteristics

Conditions Vin : 230VAC
Iout : 100%
Phase : L

雑音端子電圧
Conducted Emission

5 V

Ref.	Point A (660.0 KHz)	
	Data	Measure (dBuV)
QP	Limit (dBuV)	48.0
AV	Limit (dBuV)	46.0
		36.7
		36.4

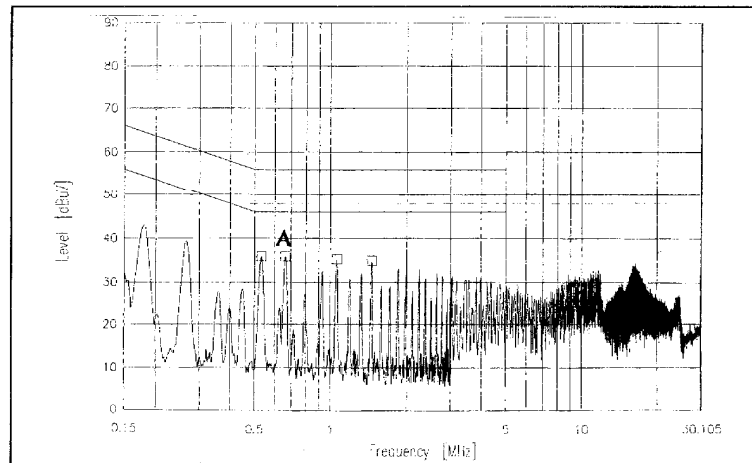

VCCI Class 2
QP Limit
VCCI Class 2
AV Limit
FCC Class B
QP Limit

12V

Ref.	Point B (15.958MHz)	
	Data	Measure (dBuV)
QP	Limit (dBuV)	48.0
AV	Limit (dBuV)	50.0
		39.1
		34.3

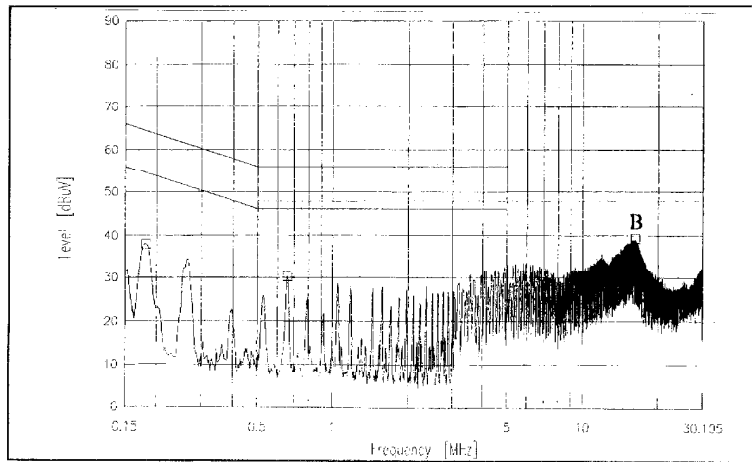

VCCI Class 2
QP Limit
VCCI Class 2
AV Limit
FCC Class B
QP Limit

24V

Ref.	Point C (4.610MHz)	
	Data	Measure (dBuV)
QP	Limit (dBuV)	48.0
AV	Limit (dBuV)	46.0
		34.6
		33.3

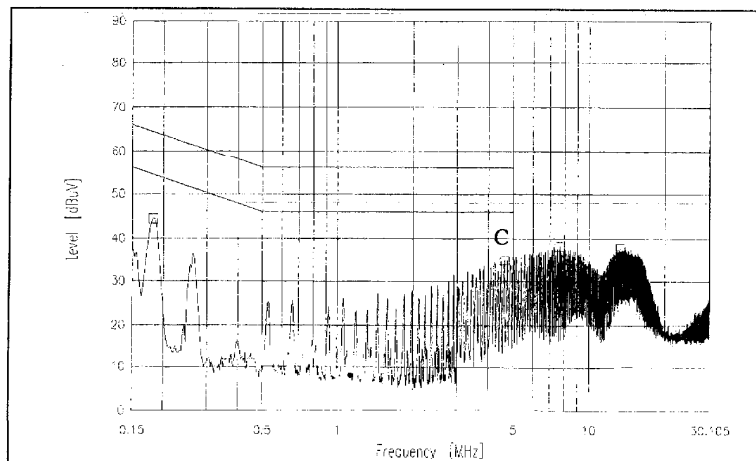

VCCI Class 2
QP Limit
VCCI Class 2
AV Limit
FCC Class B
QP Limit

EN55011-B,EN55022-Bの限度値はVCCI class Bの限度値と同じ
Limits of EN55011-B and EN55022-B are same as its VCCI class B.

2.19 EMI特性

Electro-Magnetic Interference characteristics

Conditions Vin : 230VAC

Iout : 100%

Phase : N

雑音端子電圧

Conducted Emission

5 V

Ref.	Point A (661.0 KHz)	
	Limit (dBuV)	Measure (dBuV)
QP	48.0	34.7
AV	46.0	34.3

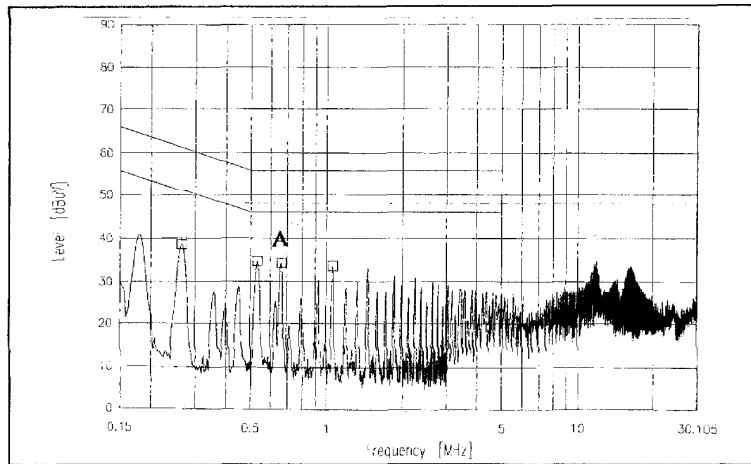

VCCI Class 2
QP Limit
VCCI Class 2
AV Limit
FCC Class B
QP Limit

12V

Ref.	Point B (15.828MHz)	
	Limit (dBuV)	Measure (dBuV)
QP	48.0	39.3
AV	50.0	34.8

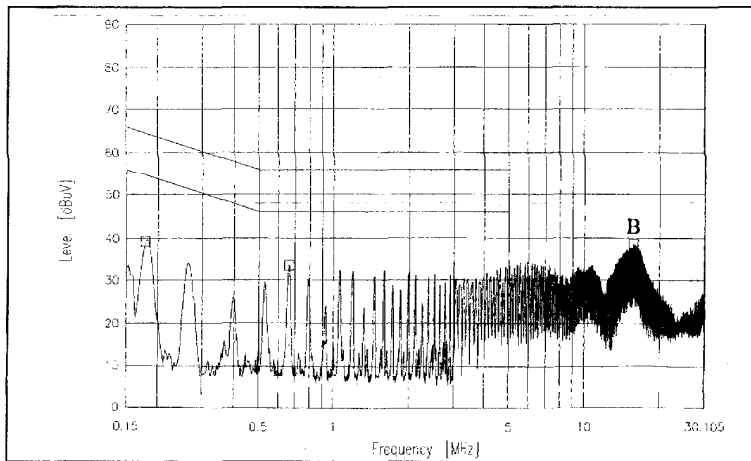

VCCI Class 2
QP Limit
VCCI Class 2
AV Limit
FCC Class B
QP Limit

24V

Ref.	Point C (8.031MHz)	
	Limit (dBuV)	Measure (dBuV)
QP	48.0	39.9
AV	50.0	37.2

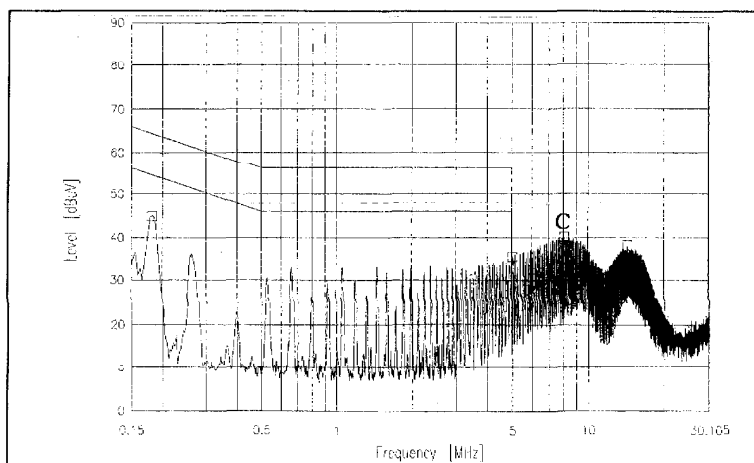

VCCI Class 2
QP Limit
VCCI Class 2
AV Limit
FCC Class B
QP Limit

EN55011-B,EN55022-Bの限度値はVCCI class Bの限度値と同じ
Limits of EN55011-B and EN55022-B are same as its VCCI class B.

2.19 EMI 特性
Electro-Magnetic Interference characteristics

Conditions Vin : 100VAC
Iout : 100%

雑音電界強度
Radiated Emission

5 V

HORIZONTAL:

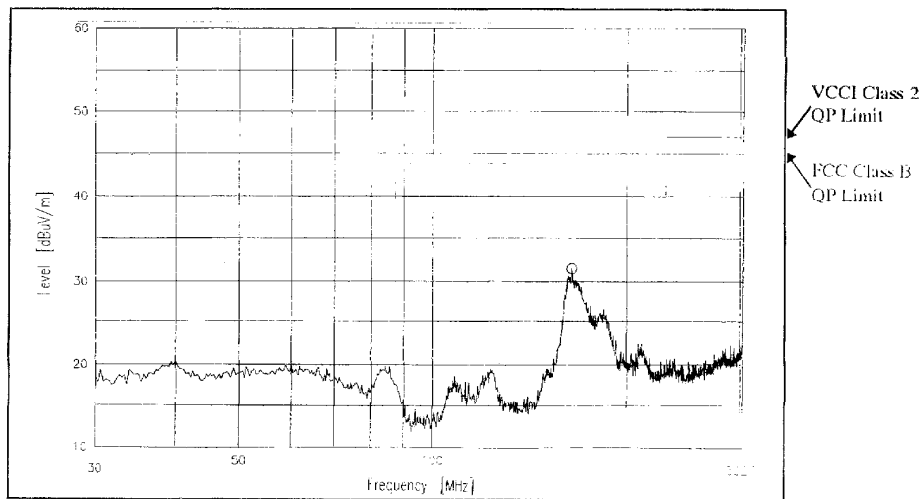

VERTICAL:

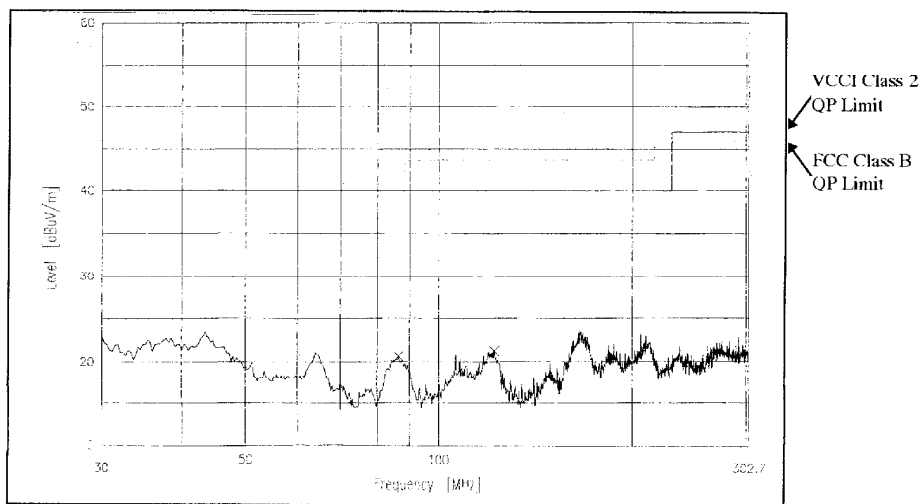

EN55011-B,EN55022-Bの限度値はVCCI class Bの限度値と同じ
Limits of EN55011-B and EN55022-B are same as its VCCI class B.

2.19 EMI 特性
Electro-Magnetic Interference characteristics

Conditions Vin : 230VAC
Iout : 100%

雑音電界強度
Radiated Emission

5 V

HORIZONTAL:

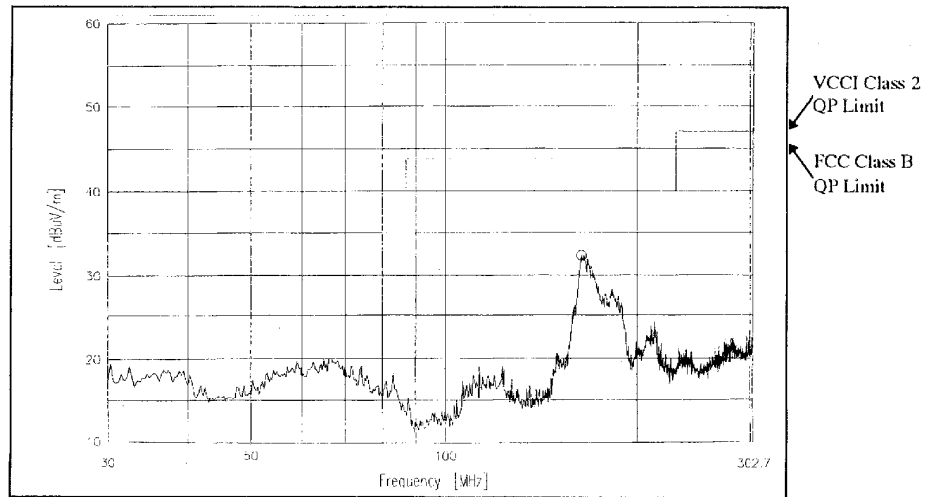

VERTICAL:

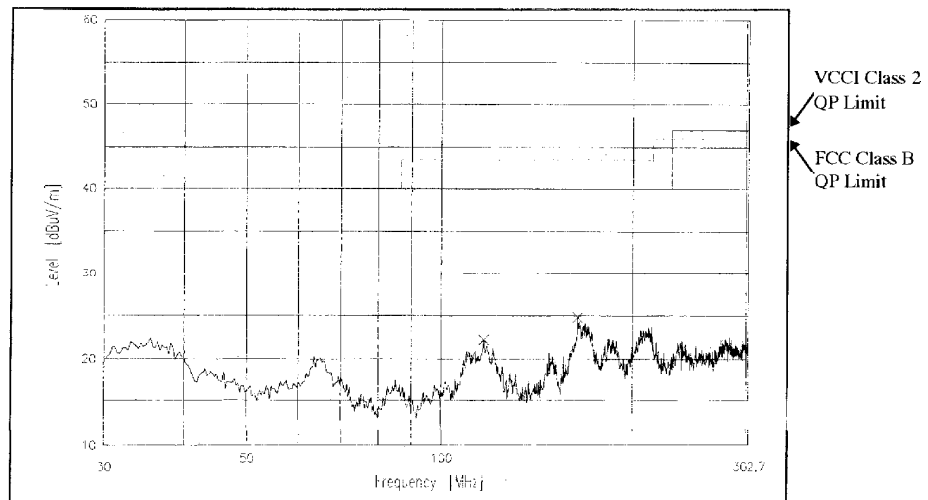

EN55011-B, EN55022-Bの限度値はVCCI class Bの限度値と同じ
Limits of EN55011-B and EN55022-B are same as its VCCI class B.

2.19 EMI 特性

Electro-Magnetic Interference characteristics

Conditions Vin : 100VAC
Iout : 100%

雑音電界強度
Radiated Emission

12 V

HORIZONTAL:

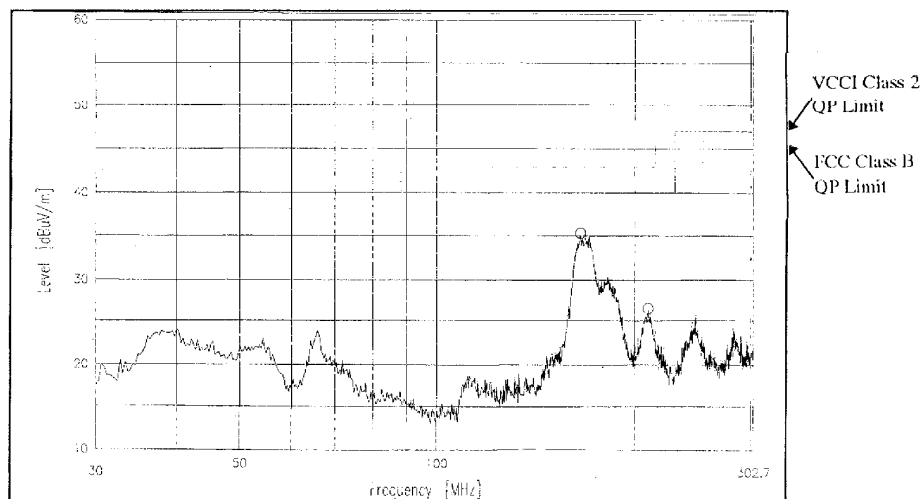

VERTICAL:

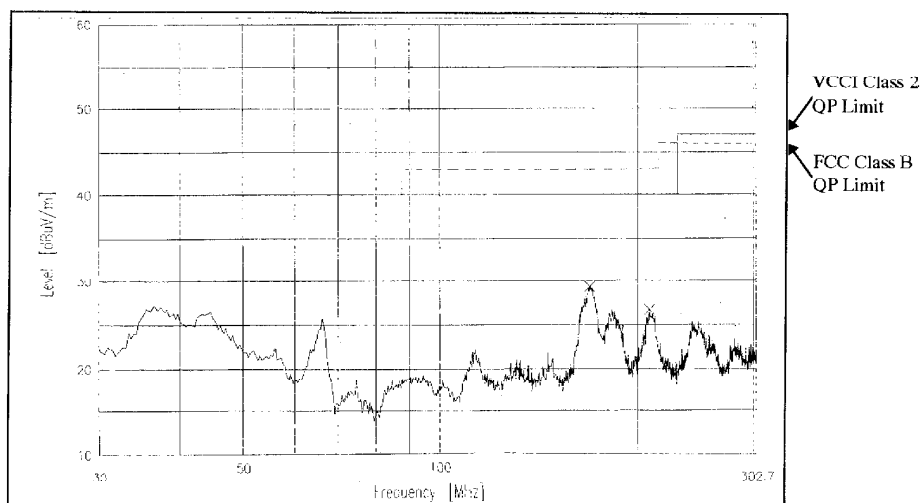

EN55011-B,EN55022-Bの限度値はVCCI class Bの限度値と同じ
Limits of EN55011-B and EN55022-B are same as its VCCI class B.

2.19 EMI 特性

Electro-Magnetic Interference characteristics

Conditions Vin : 230VAC
Iout : 100%

雑音電界強度

Radiated Emission

12 V

HORIZONTAL:

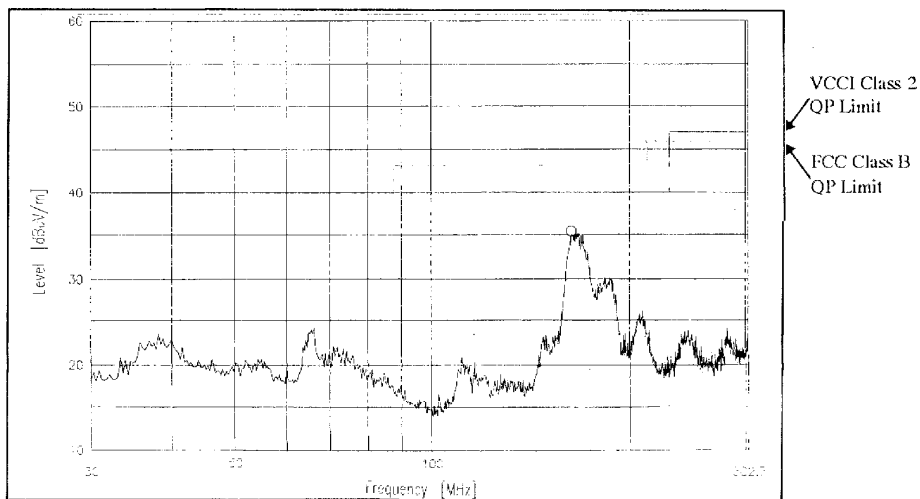

VERTICAL:

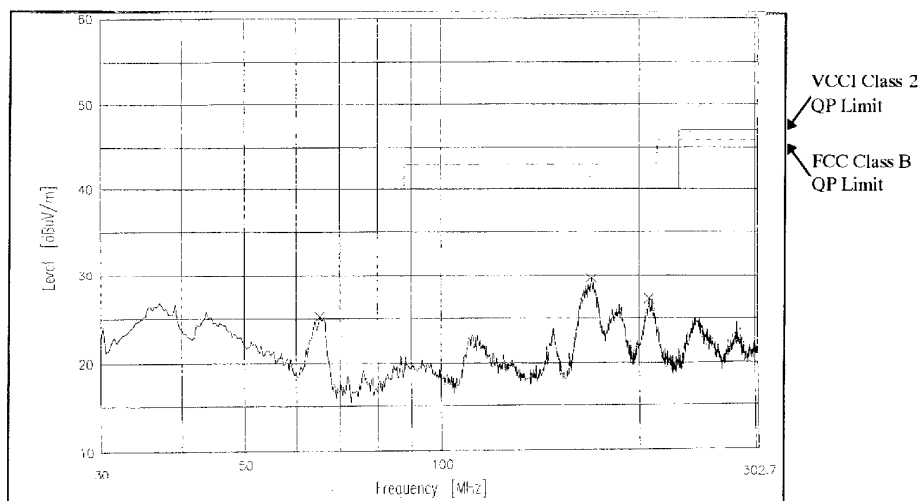

EN55011-B,EN55022-Bの限度値はVCCI class Bの限度値と同じ
Limits of EN55011 B and EN55022 B are same as its VCCI class B.

2.19 EMI 特性
Electro-Magnetic Interference characteristics

Conditions Vin : 100VAC
Iout : 100%

雑音電界強度
Radiated Emission

24 V

HORIZONTAL:

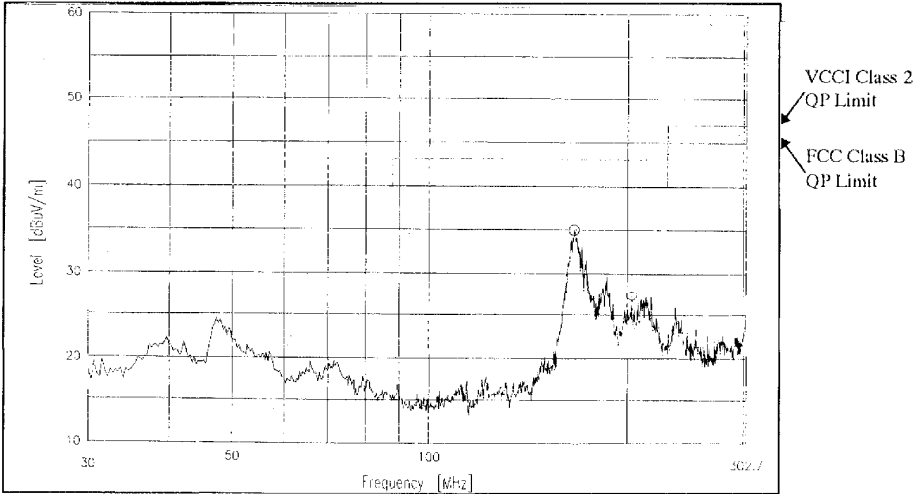

VERTICAL:

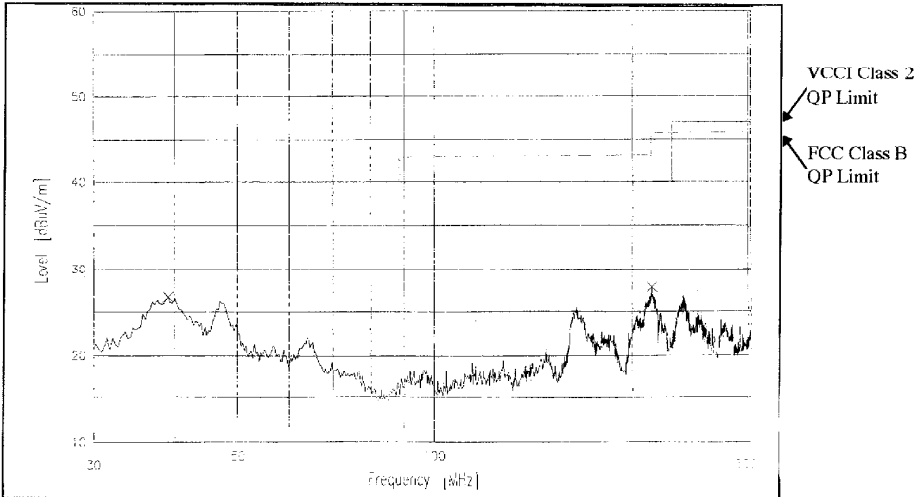

EN55011-B,EN55022-Bの限度値はVCCI class Bの限度値と同じ
Limits of EN55011-B and EN55022-B are same as its VCCI class B.

2.19 EMI 特性

Electro-Magnetic Interference characteristics

Conditions Vin : 230VAC
Iout : 100%

雑音電界強度
Radiated Emission

24 V

HORIZONTAL:

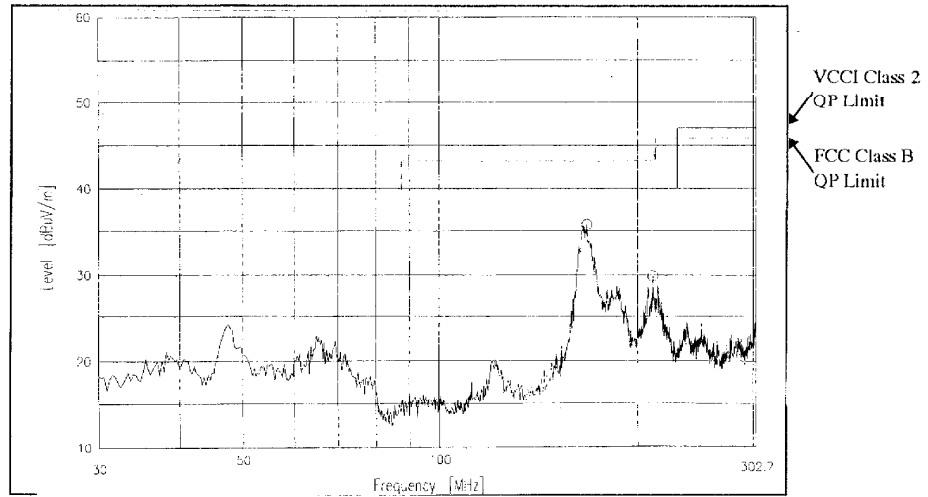

VERTICAL:

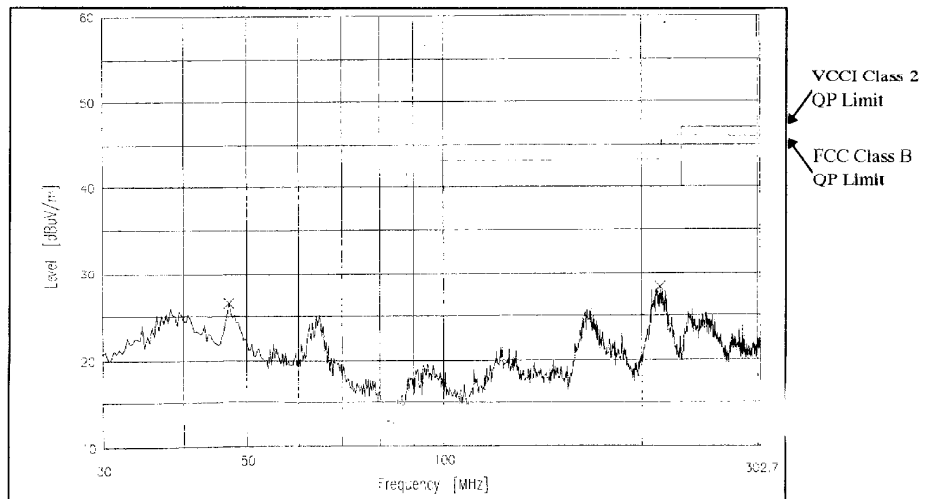

EN55011-B,EN55022-Bの限度値はVCCI class Bの限度値と同じ
Limits of EN55011-B and EN55022-B are same as its VCCI class B.