

JWS240P

EVALUATION DATA

型式データ

DWG No. A182-53-01			
QA APPD	APPD	CHK	DWG
<i>Imurayama</i>	<i>S. Koyama</i>	<i>S. Koyama</i>	<i>F. Utsunomiya</i>
3/Sep/99	23/Aug/99	23/Aug/99	23/Aug/99

INDEX

1. 測定方法	Evaluation Method	PAGE
1.1	測定回路 Circuit used for determination	T-1~5
	(1) 静特性 Steady state data	
	(2) 通電ドリフト特性 Warm up voltage drift characteristics	
	(3) 過電流保護特性 Over current protection (OCP) characteristics	
	(4) 過電圧保護特性 Over voltage protection (OVP) characteristics	
	(5) 出力立ち上がり特性 Output rise characteristics	
	(6) 出力立ち下がり特性 Output fall characteristics	
	(7) ON/OFFコントロール時出力立ち上がり特性 Output rise characteristics with ON/OFF CONTROL	
	(8) ON/OFFコントロール時出力立ち下がり特性 Output fall characteristics with ON/OFF CONTROL	
	(9) 過渡応答（入力急変）特性 Dynamic line response characteristics	
	(10) 過渡応答（負荷急変）特性 Dynamic load response characteristics	
	(11) 入力サージ電流（突入電流）特性 Inrush current characteristics	
	(12) リーク電流特性 Leakage current characteristics	
	(13) 出力リップル、ノイズ波形 Output ripple and noise waveform	
	(14) EMI特性 Electro-Magnetic Interference characteristics	
1.2	使用測定機器 List of equipment used	T-6
2. 特性データ	Characteristics	
2.1	静特性 Steady state data	
	(1) 入力・負荷・温度変動 Regulation - line and load, temperature drift	T-7
	(2) 出力電圧・リップル電圧対入力電圧 Output voltage and ripple voltage vs. input voltage	T-8
	(3) 効率・入力電流対出力電流 Efficiency and input current vs. output current	T-9
	(4) 力率・入力電流対出力電流 Power factor and input current vs. output current	T-10
2.2	通電ドリフト特性 Warm up voltage drift characteristics	T-11
2.3	過電流保護特性 Over current protection (OCP) characteristics	T-12
2.4	過電圧保護特性 Over voltage protection (OVP) characteristics	T-13
2.5	出力立ち上がり特性 Output rise characteristics	T-14~15
2.6	出力立ち下がり特性 Output fall characteristics	T-16~17
2.7	ON/OFFコントロール時出力立ち上がり特性 Output rise characteristics with ON/OFF CONTROL	T-18
2.8	ON/OFFコントロール時出力立ち下がり特性 Output fall characteristics with ON/OFF CONTROL	T-19

2.9	出力保持時間特性	Hold up time characteristics	T-20
2.10	過渡応答 (入力急変) 特性	Dynamic line response characteristics	...	T-21
2.11	過渡応答 (負荷急変) 特性	Dynamic load response characteristics	..	T-22~23
2.12	入力電圧瞬停特性	Response to brown out characteristics	T-24~25
2.13	入力サージ電流 (突入電流) 特性	Inrush current waveform	T-26~27
2.14	瞬停時突入電流特性	Inrush current characteristics	T-28
2.15	入力電流波形	Input current waveform	T-29
2.16	高調波成分	Input current harmonics	T-30
2.17	リーク電流特性	Leakage current characteristics	T-31~32
2.18	出力リップル、ノイズ波形	Output ripple and noise waveform	T-33~34
2.19	EMI特性	Electro-Magnetic Interference characteristics	T-35~37

使用記号 Terminology used

	Definition	
Vin 入力電圧	Input voltage
Vout 出力電圧	Output voltage
Iin 入力電流	Input current
Iout 出力電流	Output current
f 周波数	Frequency
Ta 周囲温度	Ambient temperature

1. 1

測定回路

Circuit used for determination

(1) 静特性

Steady state data

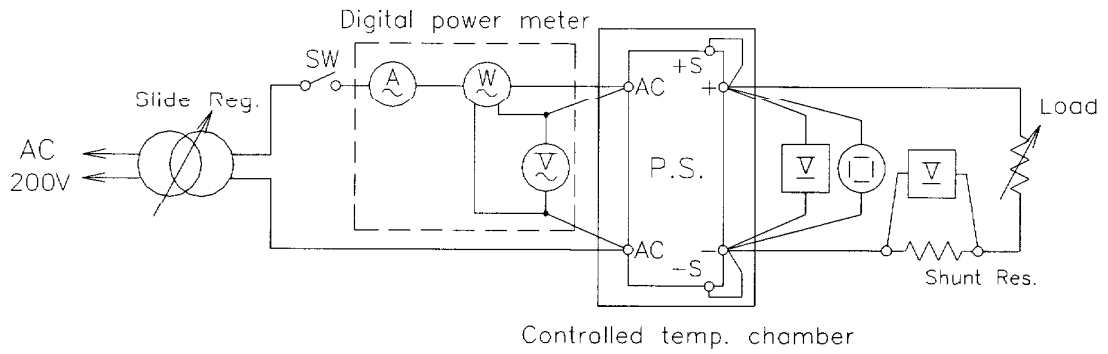

(2) 通電ドリフト特性

Warm up voltage drift characteristics

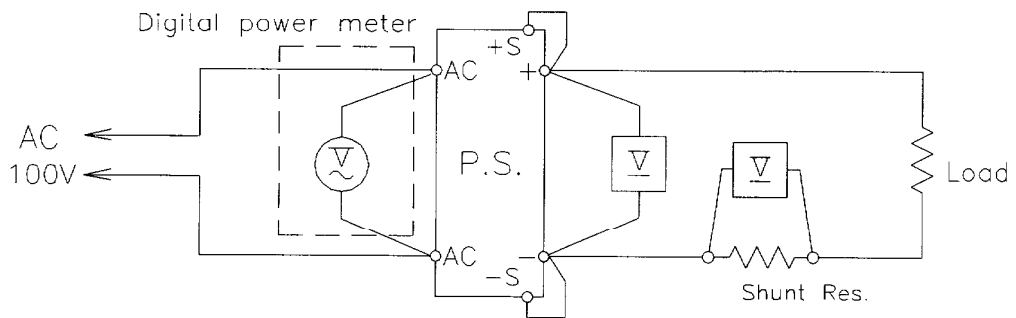

(3) 過電流保護特性

Over current protection (O.C.P.) characteristics

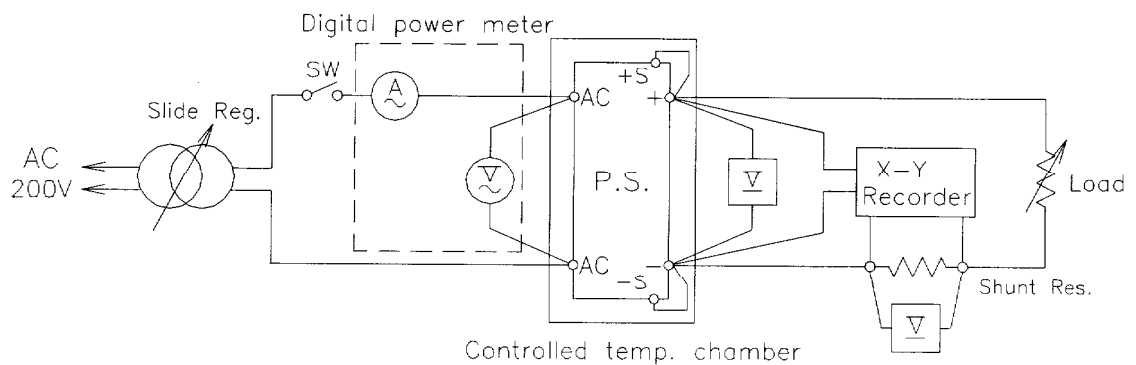

(4) 過電圧保護特性

Over voltage protection (O.V.P.) characteristics

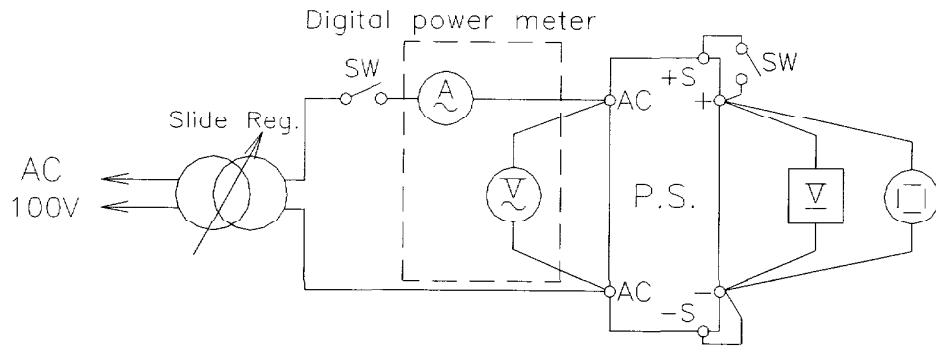

(5) 出力立ち上がり特性

Output rise characteristics

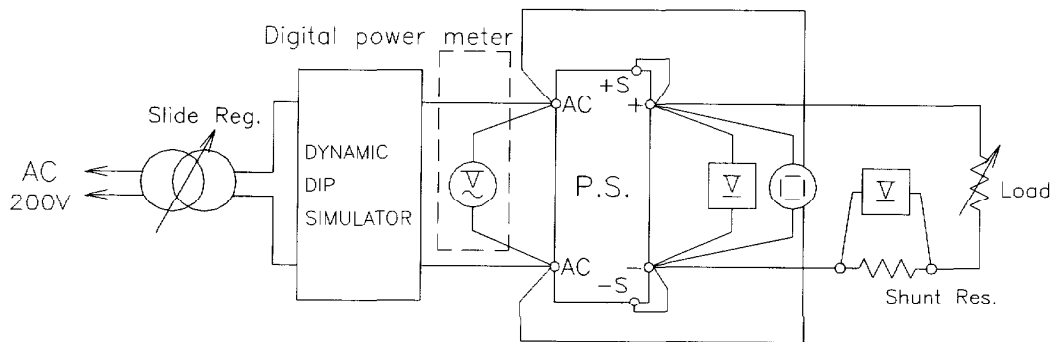

(6) 出力立ち下がり特性

Output fall characteristics

Same as output rise characteristics

(7) 出力立ち上がり特性 (ON/OFF コントロール特性)

Output rise characteristics with ON/OFF CONTROL

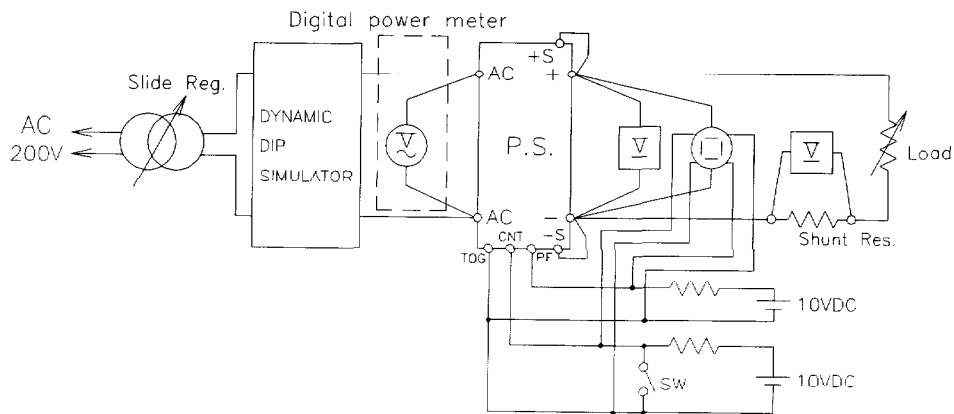

(8) 出力立ち下がり特性 (ON/OFF コントロール特性)

Output fall characteristics with ON/OFF CONTROL

Same as output rise characteristics with ON/OFF CONTROL

(9) 過渡応答 (入力急変)

Dynamic line response characteristics

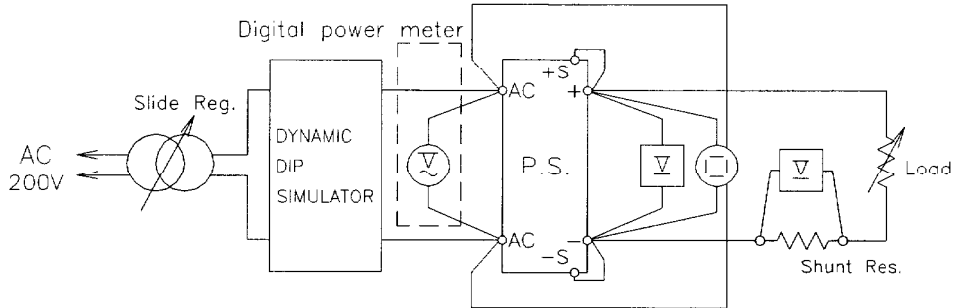

(10) 過渡応答 (負荷急変) 特性

Dynamic load response characteristics

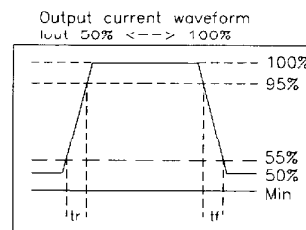
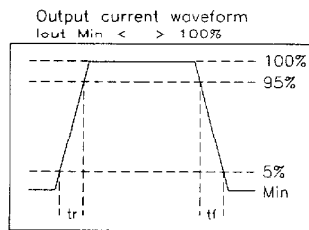
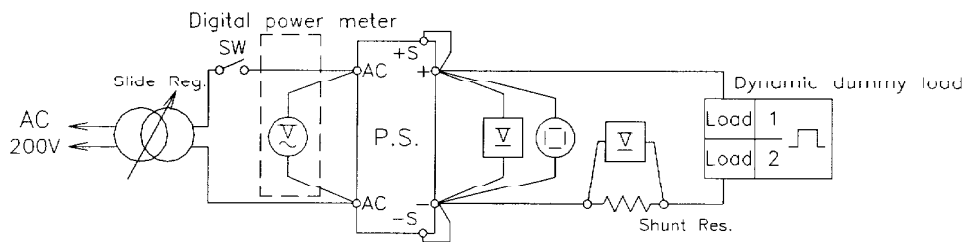

(11) 入力サージ電流 (突入電流) 特性

Inrush current characteristics

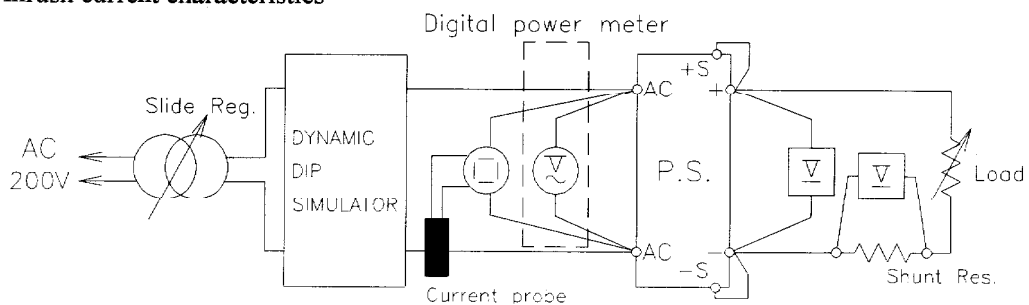

(12) リーク電流

Leakage current characteristics

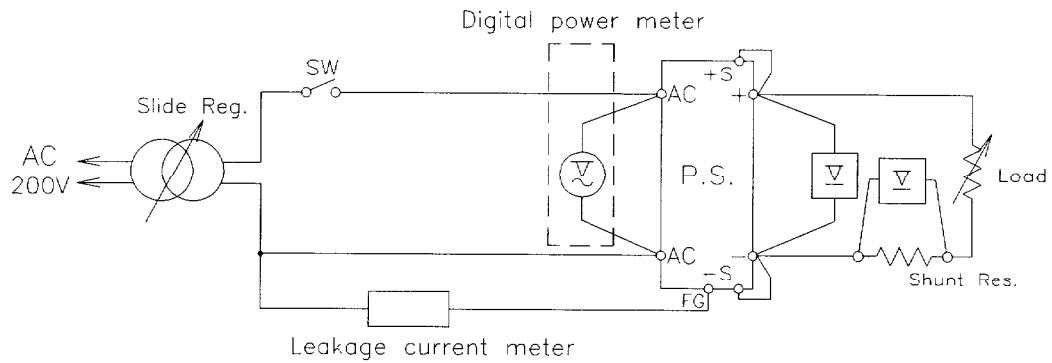

NOTE : Leakage current measured through a 1kohm resistor.
 Range used---AC+DC (For YOKOGAWA TYPE 3226)
 ---AC (For SIMPSON MODEL 229-2)

(13) 出力リップルノイズ

Output ripple noise

(a) Normal Mode

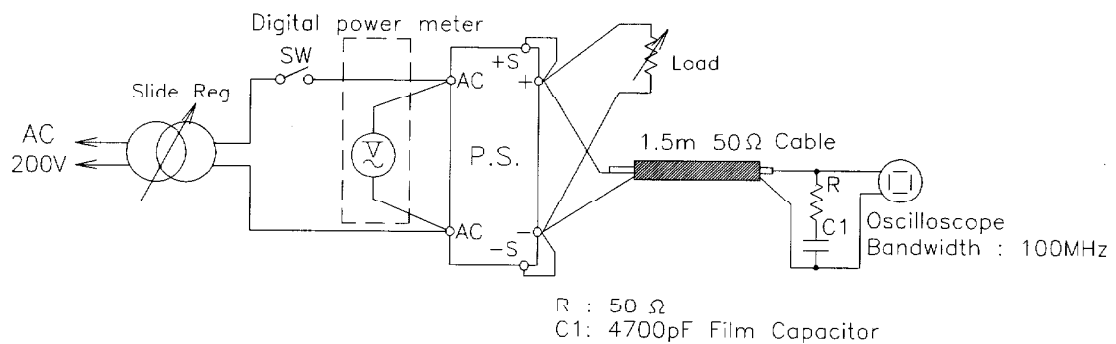

(b) Normal + Common Mode

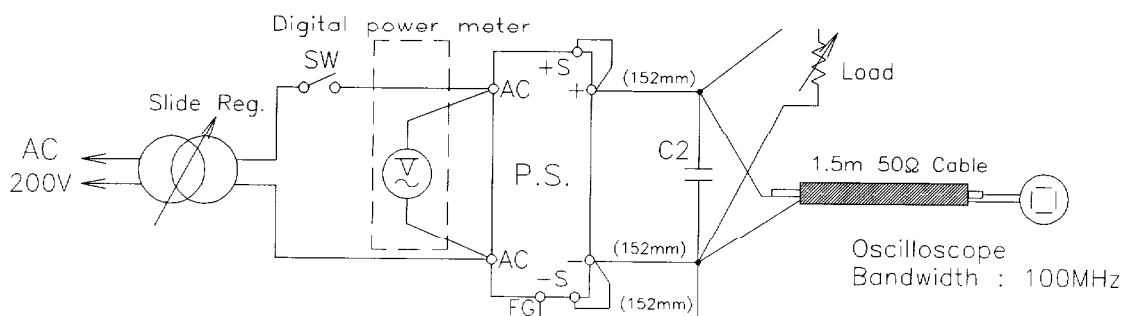

(14) EMI 特性

Electro-Magnetic Interference characteristics

(a) 雑音端子電圧 (帰還ノイズ)

Conducted Emission Noise

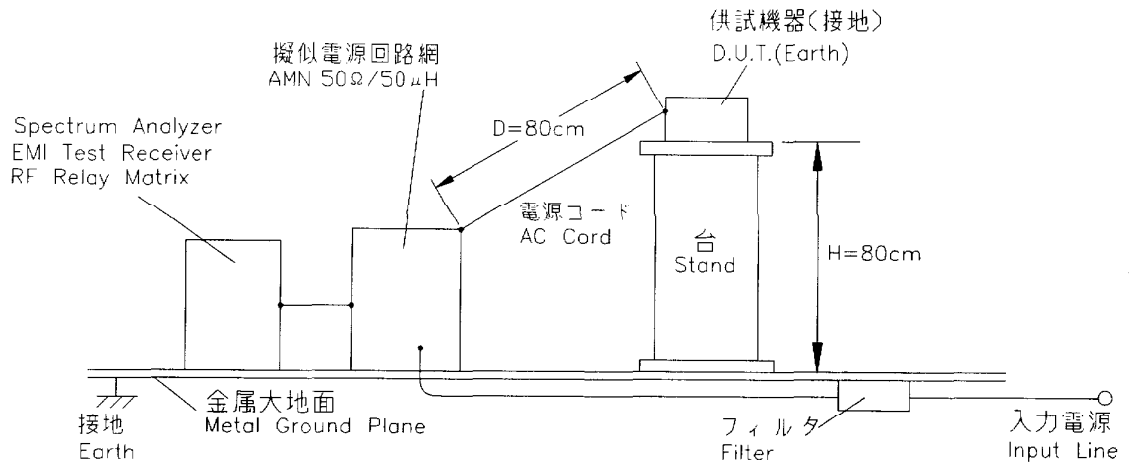

(b) 雑音電界強度 (輻射ノイズ)

Radiated Emission Noise

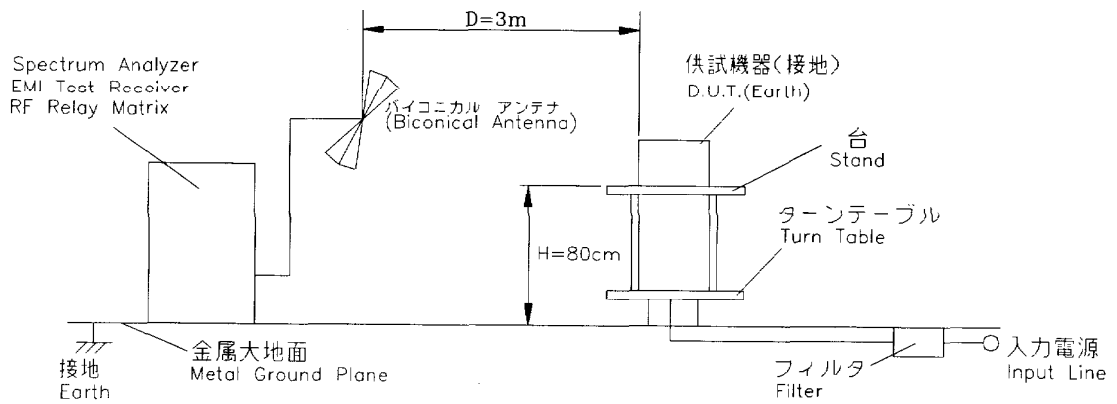

1.2 使用測定機器 LIST OF EQUIPMENT USED

	EQUIPMENT USED	MANUFACTURER	MODEL NO.
1	OSCILLOSCOPE	HITACHI DENSHI	V-1100A
2	DIGITAL STORAGE OSCILLOSCOPE	TEKTRONIX	TDS540B
3	DIGITAL MULTIMETER	ADVANTEST	R6341A
4	DIGITAL POWER METER	YOKOGAWA ELECT.	WT110
5	SHUNT RESISTOR	YOKOGAWA ELECT.	2215
6	CURRENT PROBE/AMPLIFIER	TEKTRONIX	A6303/AM503
7	DYNAMIC DUMMY LOAD	TAKASAGO	FK-1000L
8	SLIDE REGULATOR	MATSUNAGA	SD-2625
9	CVCF	KIKUSUI	PCR4000L
10	LEAKAGE CURRENT METER	SIMPSON	229-2
11	LEAKAGE CURRENT METER	YOKOGAWA	TYPE3226
12	X-Y RECORDER	GRAPHTEC	WX3000-1
13	DYNAMIC DIP SIMULATOR	TAKAMISAWA CYBERNETICS	PSA-300
14	CONTROLLED TEMP. CHAMBER	TARAI ESPEC	PIJ-4KPH-A
15	SPECTRUM ANALYZER	ROHDE & SCHWARZ	FSA
16	EMI TEST RECEIVER	ROHDE & SCHWARZ	ESHS10
17	EMI TEST RECEIVER	ROHDE & SCHWARZ	ESVS10
18	RF RELAY MATRIX	ROHDE & SCHWARZ	PSU
19	AMN	KYORITSU DENSHI	KNW-242
20	ANTENNA(BICONICAL ANTENNA)	SCHWARZBECK	BBA9106

2. 特性データ Characteristics

2.1 静特性 Steady state data

(1) 入力、負荷、温度変動 Regulation - line and load, temperature drift

24V	1. Regulation - line and load					condition Ta : 25°C	
	Iout \ Vin	85VAC	100VAC	200VAC	265VAC	line regulation	
	0%	24.012V	24.012V	24.011V	24.009V	3mV	0.012%
	50%	24.020V	24.020V	24.019V	24.019V	1mV	0.004%
	100%	24.027V	24.027V	24.026V	24.026V	1mV	0.004%
	load	15mV	15mV	14mV	17mV		
	regulation	0.063%	0.063%	0.058%	0.071%		

2. Temperature drift conditions Vin=100VAC
Io =100%

Ta	-10°C	+25°C	+50°C	temperature stability	
Vo	23.968V	24.027V	24.036V	68mV	0.28%

48V	1. Regulation - line and load					condition Ta : 25°C	
	Iout \ Vin	85VAC	100VAC	200VAC	265VAC	line regulation	
	0%	47.95V	47.95V	47.95V	47.94V	10mV	0.021%
	50%	47.97V	47.97V	47.97V	47.97V	0mV	0.000%
	100%	47.98V	47.98V	47.98V	47.98V	0mV	0.000%
	load	30mV	30mV	30mV	40mV		
	regulation	0.06%	0.06%	0.06%	0.08%		

2. Temperature drift conditions Vin=100VAC
Io =100%

Ta	-10°C	+25°C	+50°C	temperature stability	
Vo	47.83V	47.98V	48.06V	230mV	0.48%

2.1 (2) 出力電圧、リップル電圧対入力電圧

Output voltage and Ripple voltage v.s. Input voltage

Conditions Iout : 100%

Ta : -10°C

: 25°C

: 50°C

—————

24V

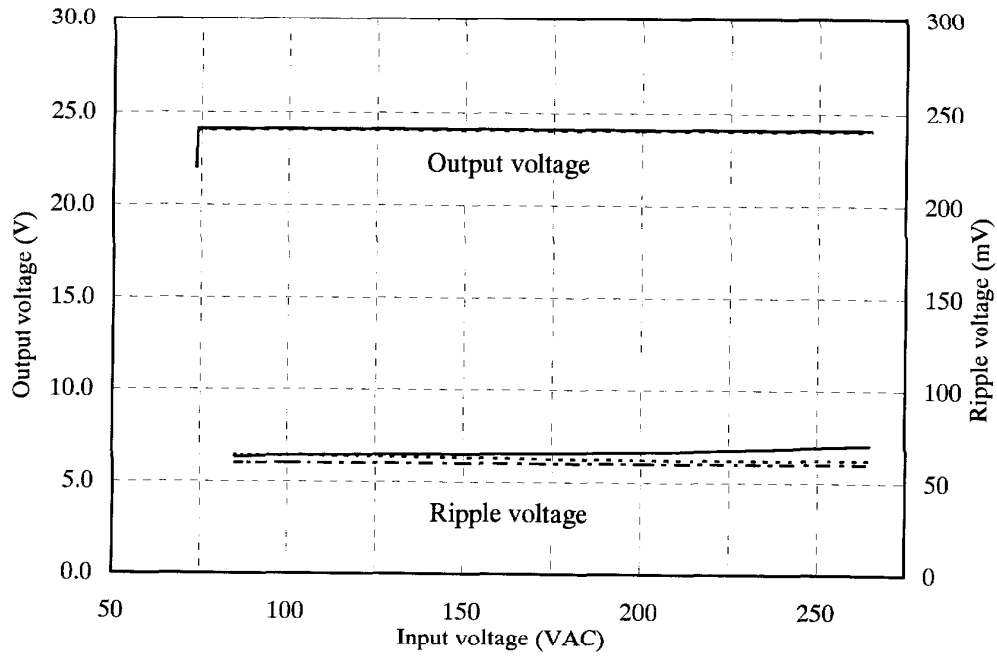

48V

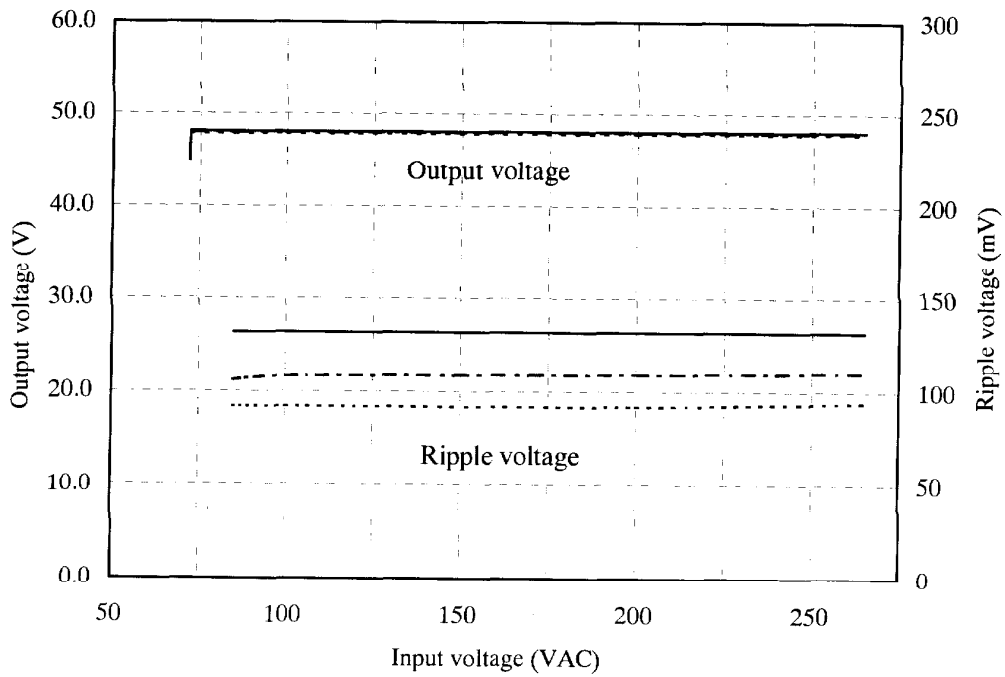

2.1 (3) 効率、入力電流対出力電流

Efficiency and Input current v.s. Output current

Conditions Vin : 85VAC -----
 : 100VAC -.-.-.-
 : 200VAC ————
 : 265VAC - - - - -
 Ta : 25°C

24V

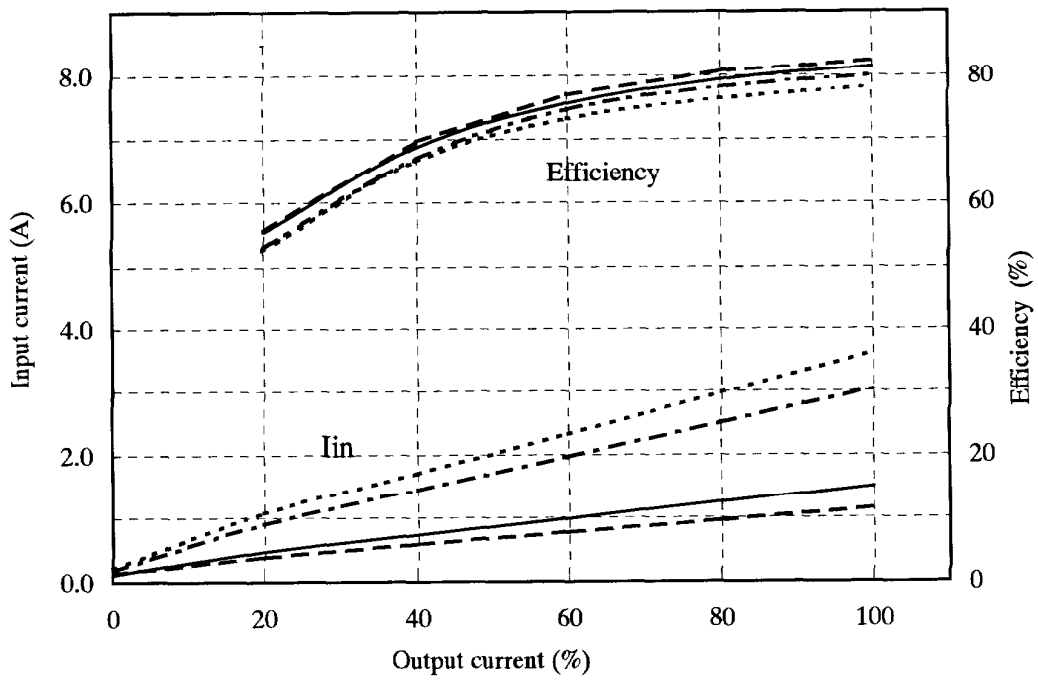

48V

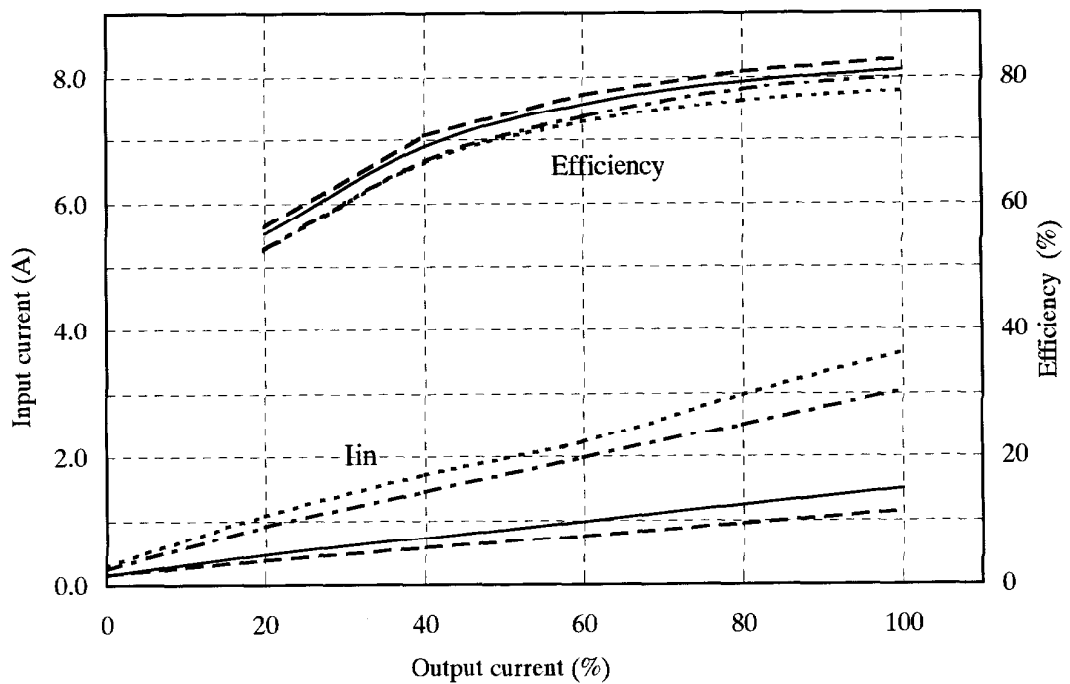

2.1 (4) 力率、入力電流対出力電流

Power factor and Input current v.s. Output current

Conditions Vin : 85VAC -----
 : 100VAC - - - - -
 : 200VAC ————
 : 265VAC - - - - -
 Ta : 25°C

24V

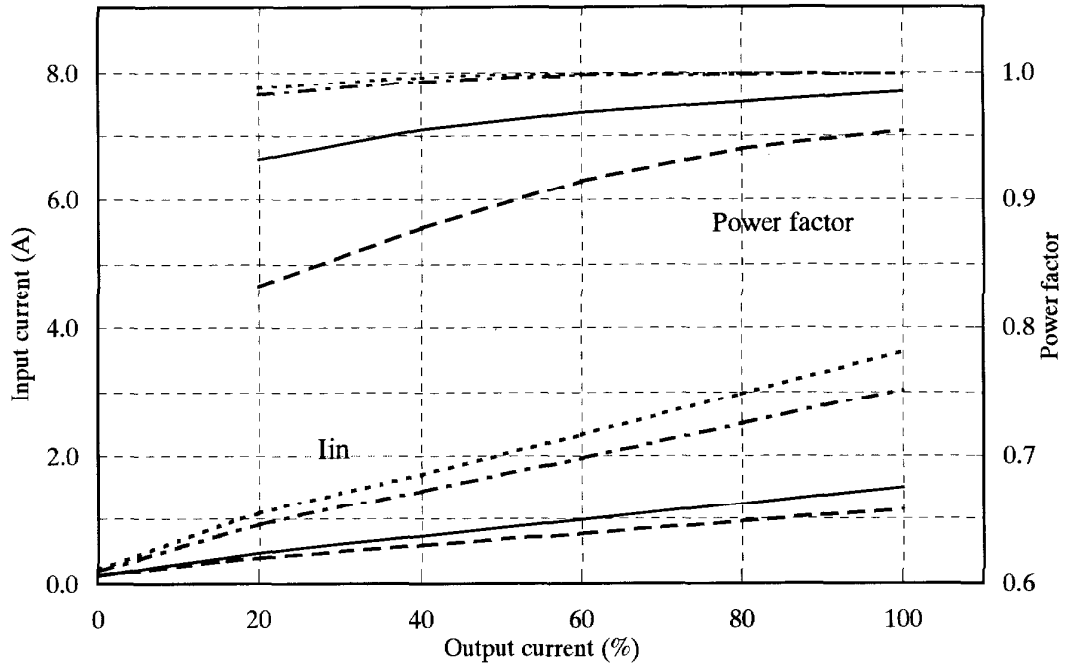

48V

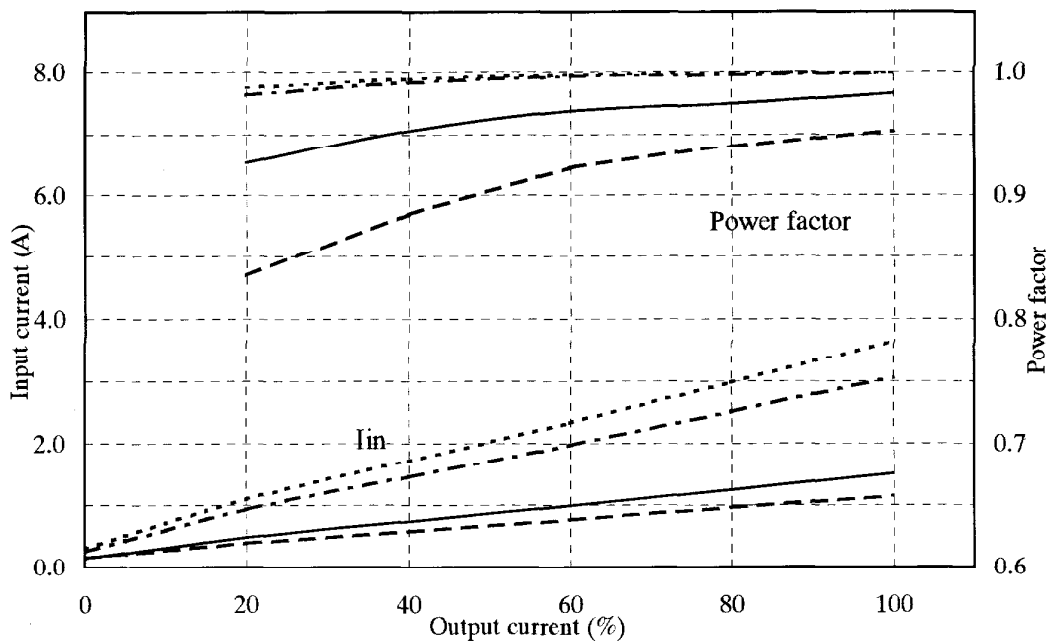

2.2 通電ドリフト特性
Warm up voltage drift characteristics

Conditions V_{in} : 100VAC
 I_{out} : 100%
 T_a : 25°C

24V

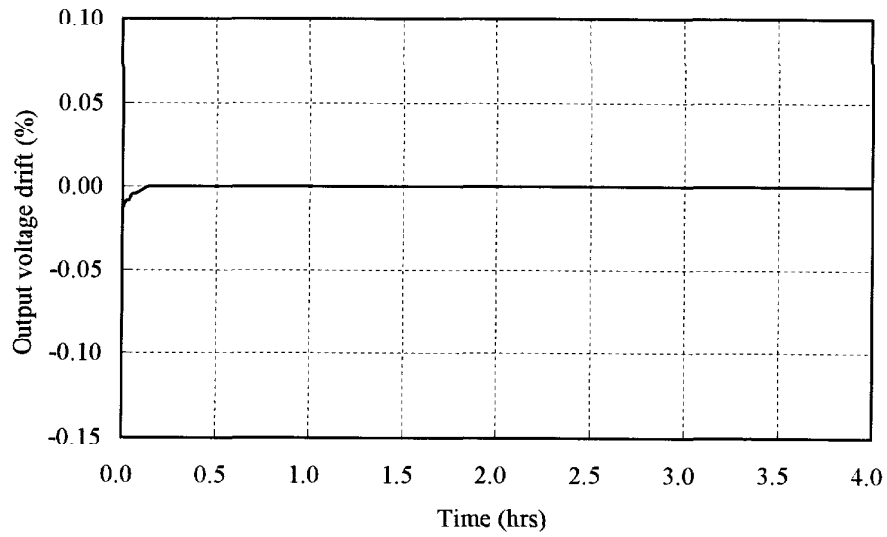

48V

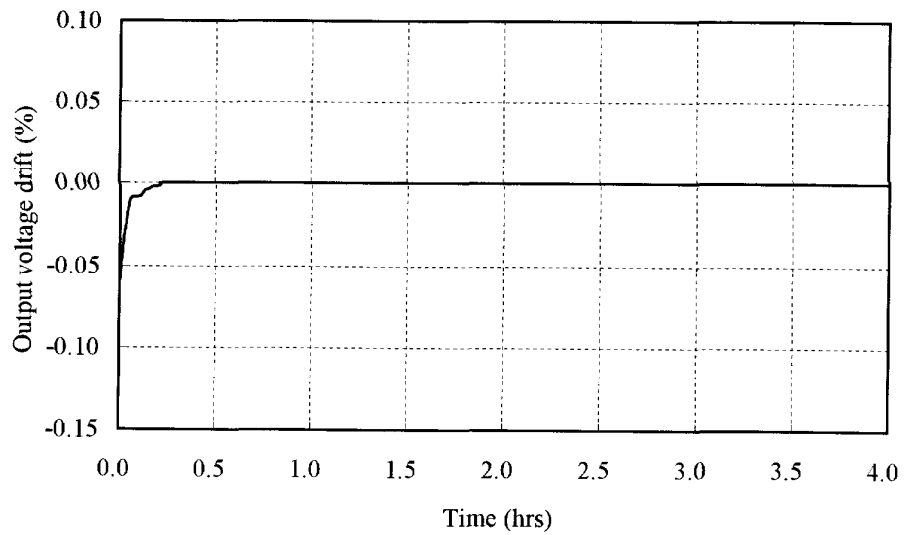

2.3 過電流保護特性

Over current protection (OCP) characteristics

Conditions Ta : -10°C -----
 : 25°C - - - - -
 : 50°C _____
 Vin : 85-265VAC

24V

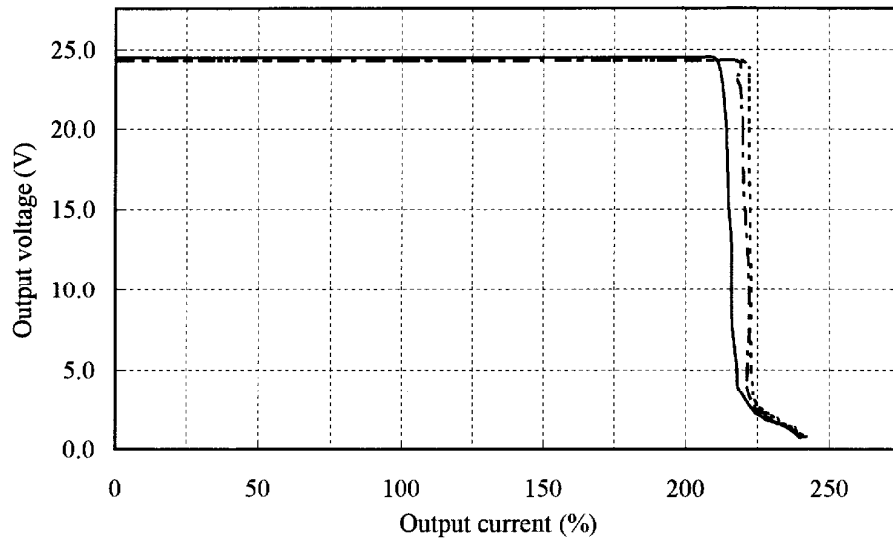

48V

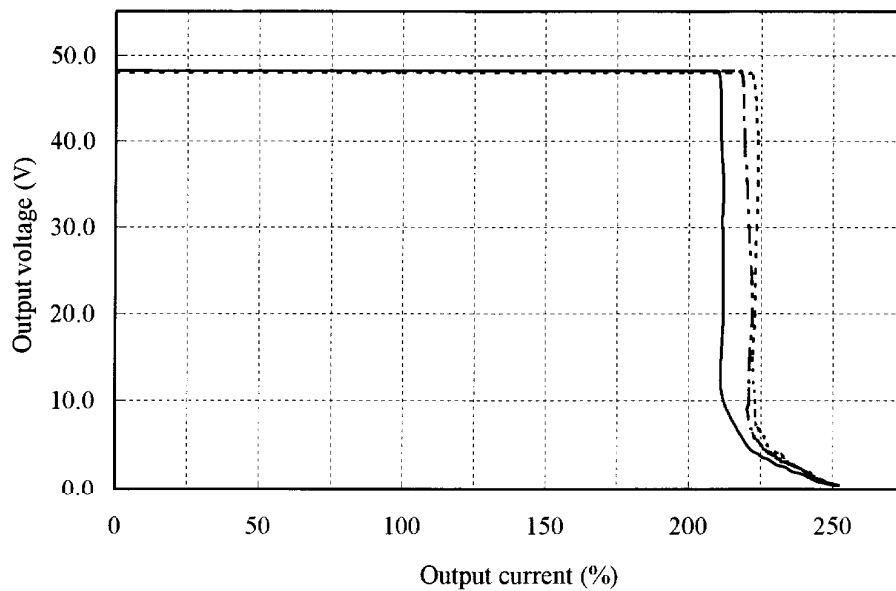

2.4 過電圧保護特性
Over voltage protection (OVP) characteristics

Conditions Vin : 100VAC
Iout : 0%
Ta : 25°C

24V

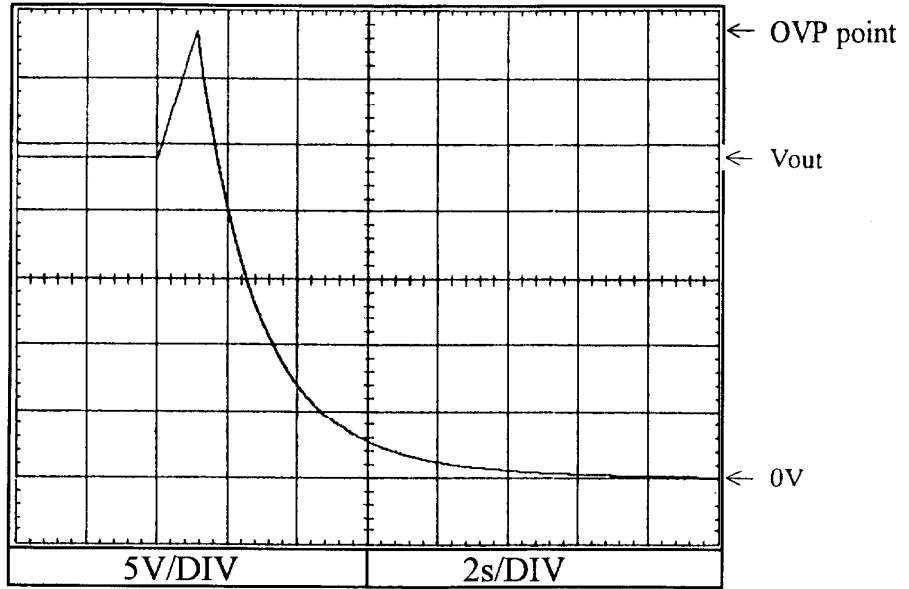

48V

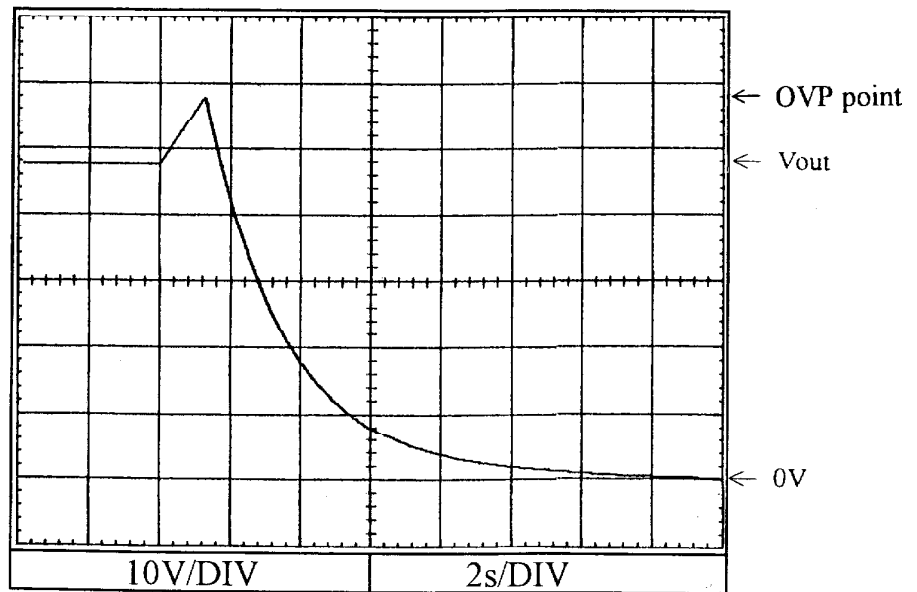

2.5 出力立ち上がり特性
Output rise characteristics

Conditions Vin : 85VAC (A)
 : 100VAC (B)
 : 200VAC (C)
 : 265VAC (D)
Iout : 0%
Ta : 25°C

24V

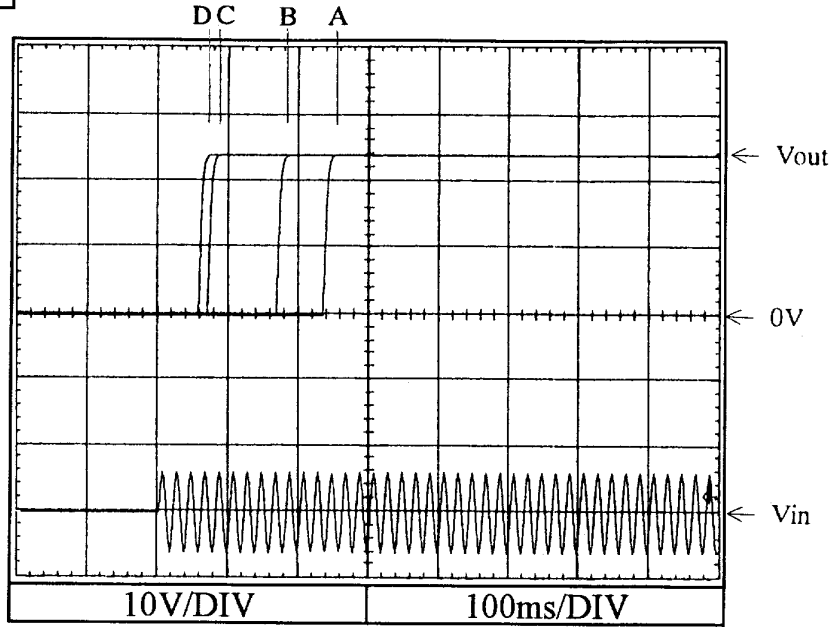

48V

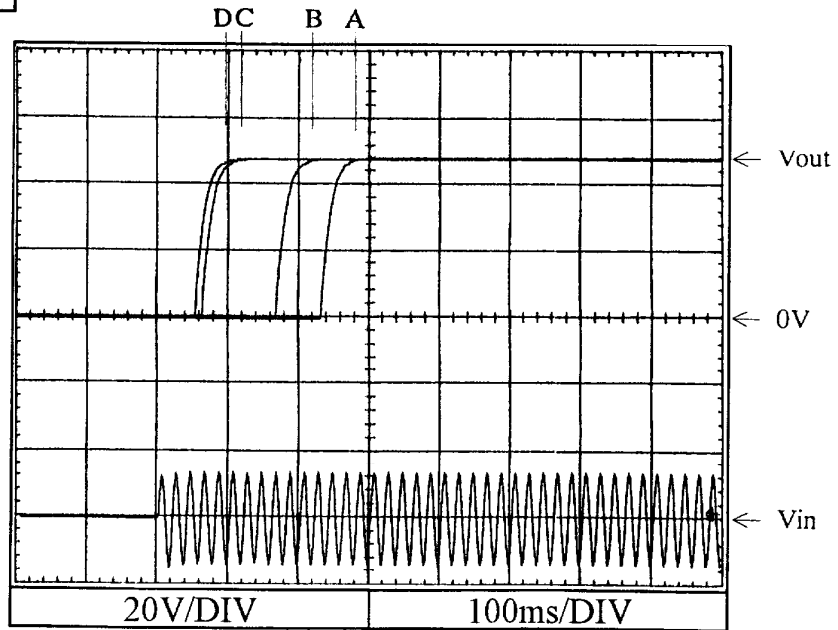

2.5 出力立ち上がり特性
Output rise characteristics

Conditions Vin : 85VAC (A)
: 100VAC (B)
: 200VAC (C)
: 265VAC (D)
Iout : 100%
Ta : 25°C

24V

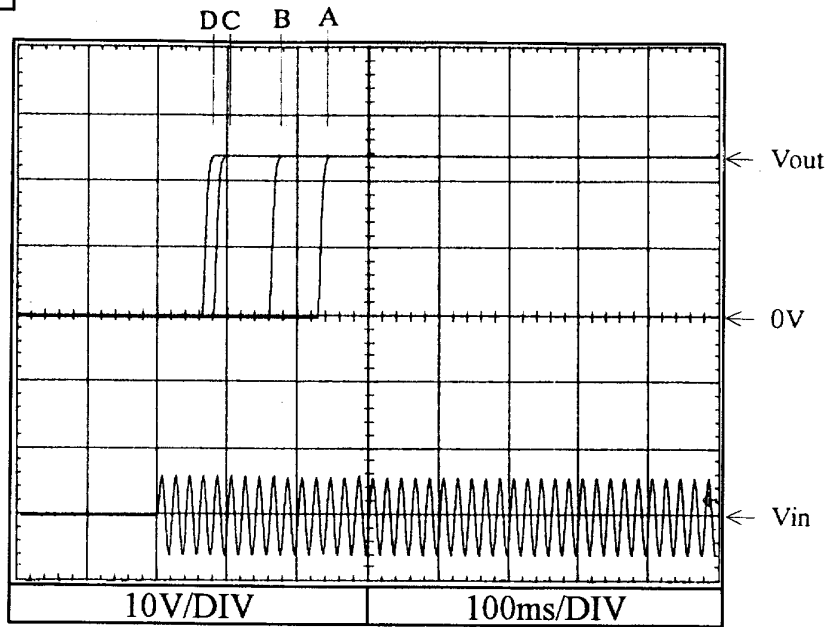

48V

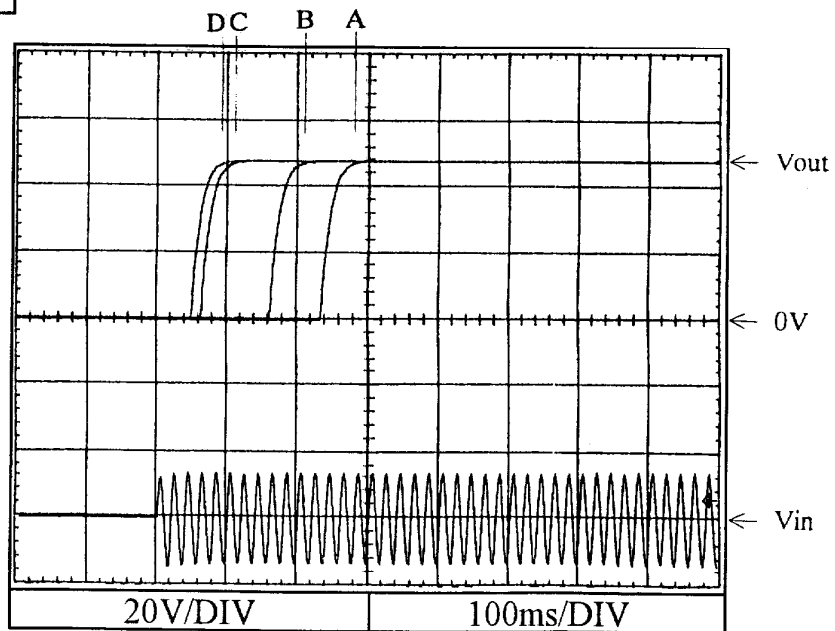

2.6 出力立ち下がり特性
Output fall characteristics

Conditions Vin : 85VAC (A)
 : 100VAC (B)
 : 200VAC (C)
 : 265VAC (D)
Iout : 0%
Ta : 25°C

24V

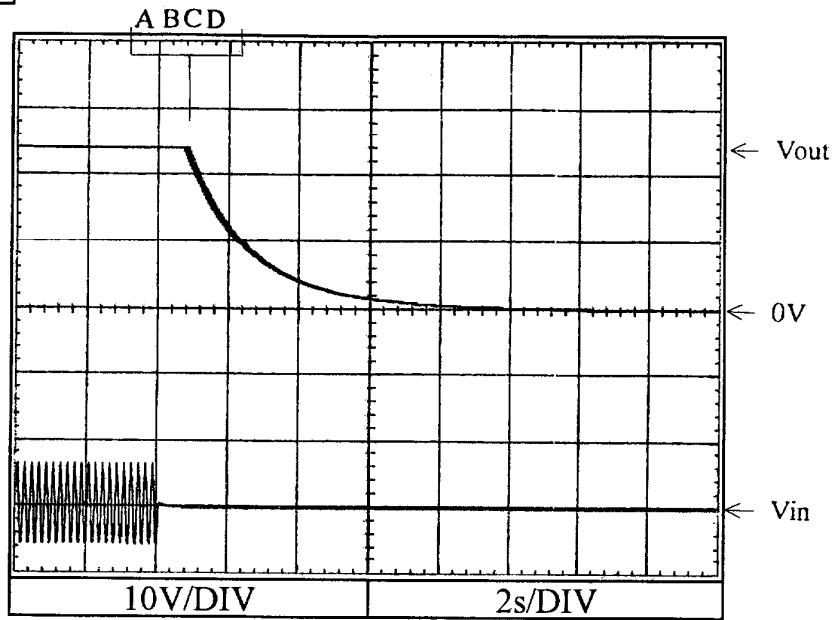

48V

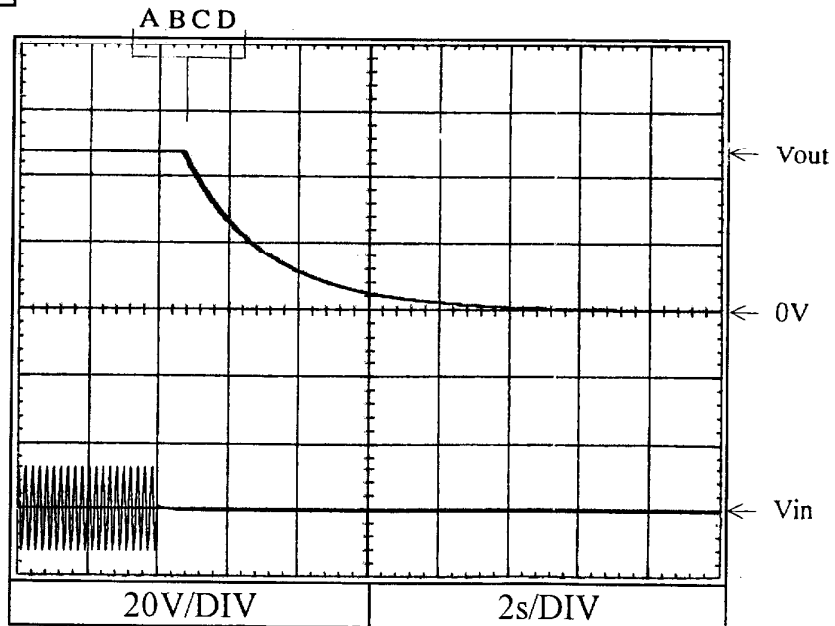

2.6 出力立ち下がり特性
Output fall characteristics

Conditions Vin : 85VAC (A)
 : 100VAC (B)
 : 200VAC (C)
 : 265VAC (D)
Iout : 100%
Ta : 25°C

24V

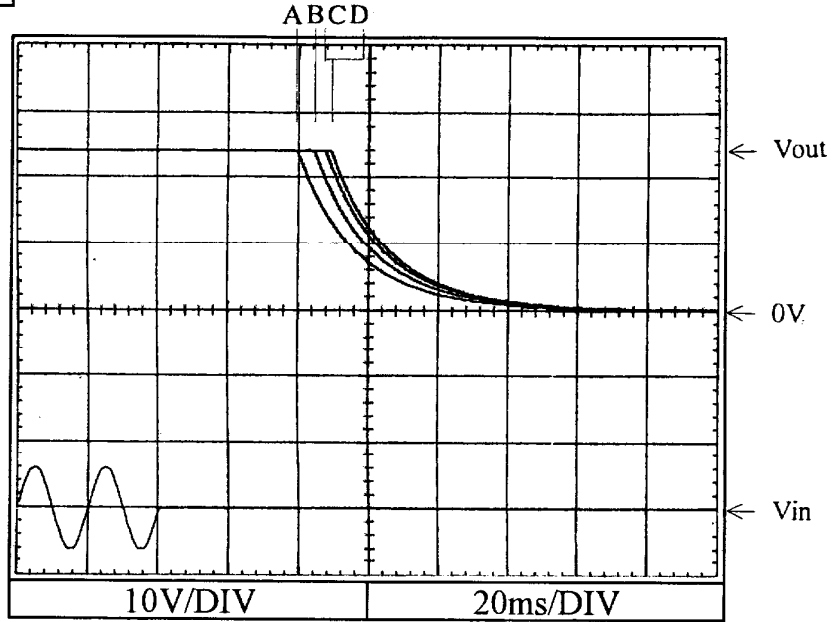

48V

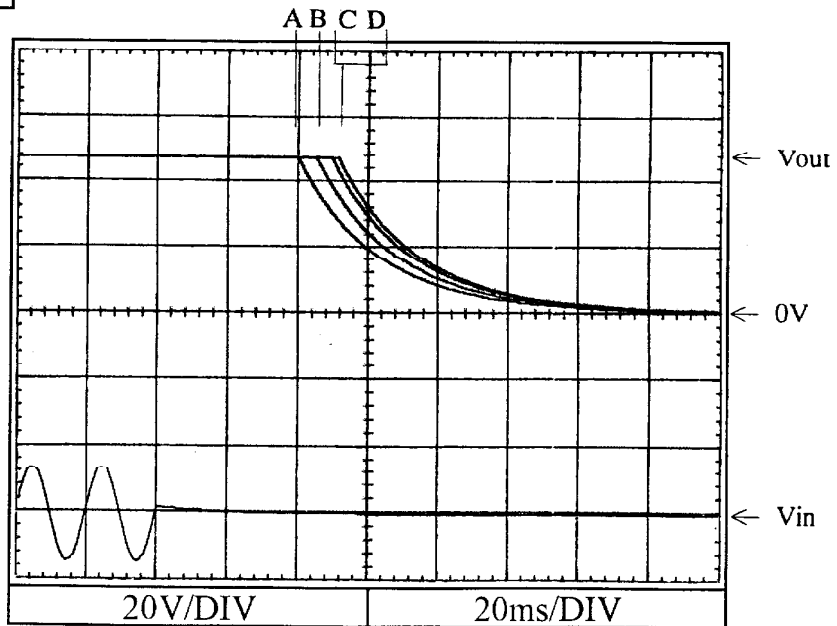

2.7 ON/OFFコントロール時出力立ち上がり特性
Output rise characteristics with ON/OFF CONTROL

Conditions Vin : 100VAC
Iout : 100%
Ta : 25°C

24V

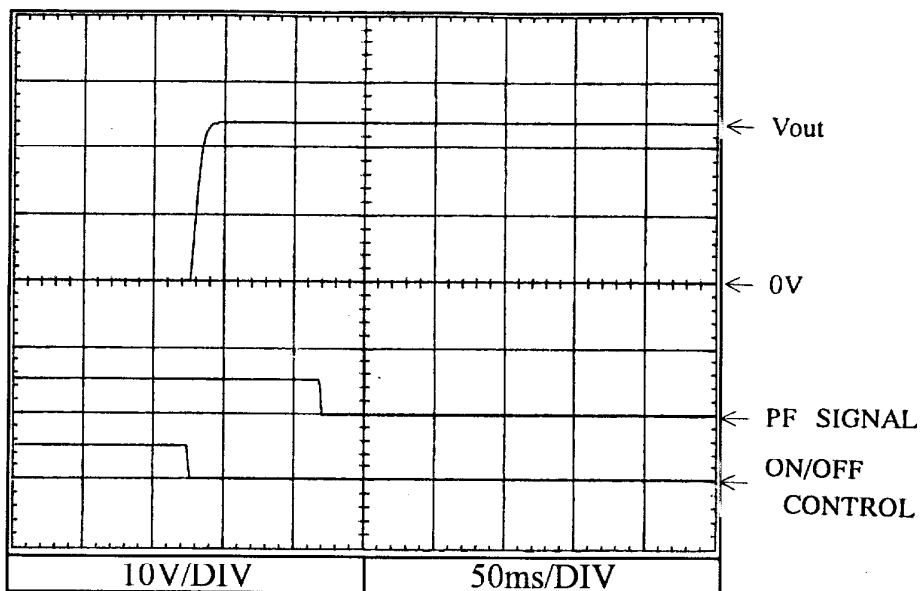

48V

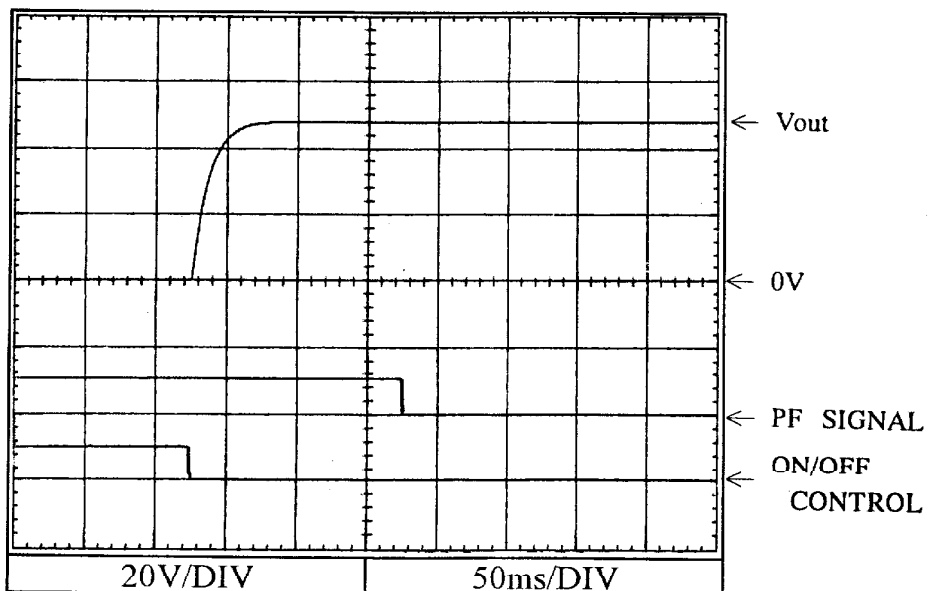

2.8 ON/OFFコントロール時出力立ち下がり特性
Output fall characteristics with ON/OFF CONTROL

Conditions V_{in} : 100VAC
 I_{out} : 100%
 T_a : 25°C

24V

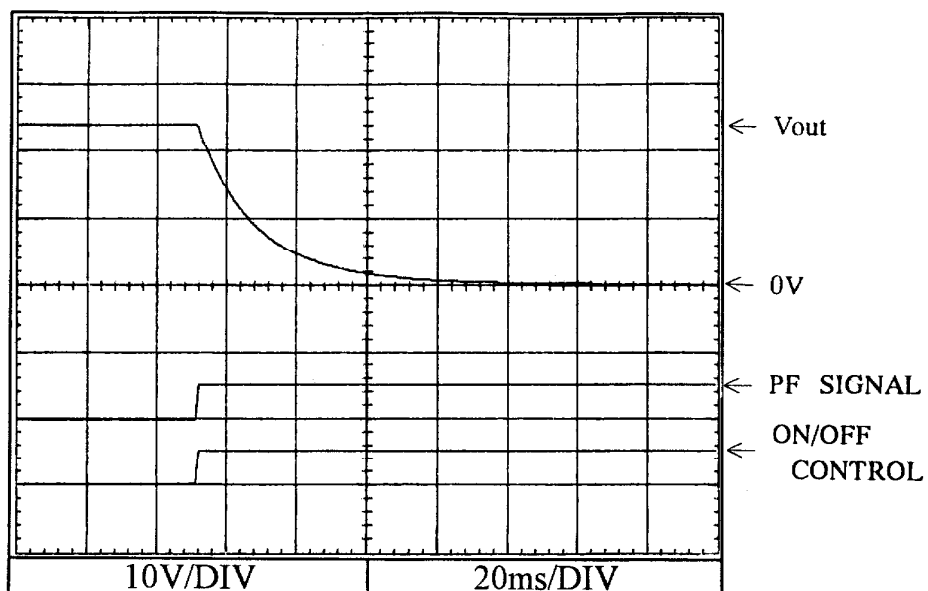

48V

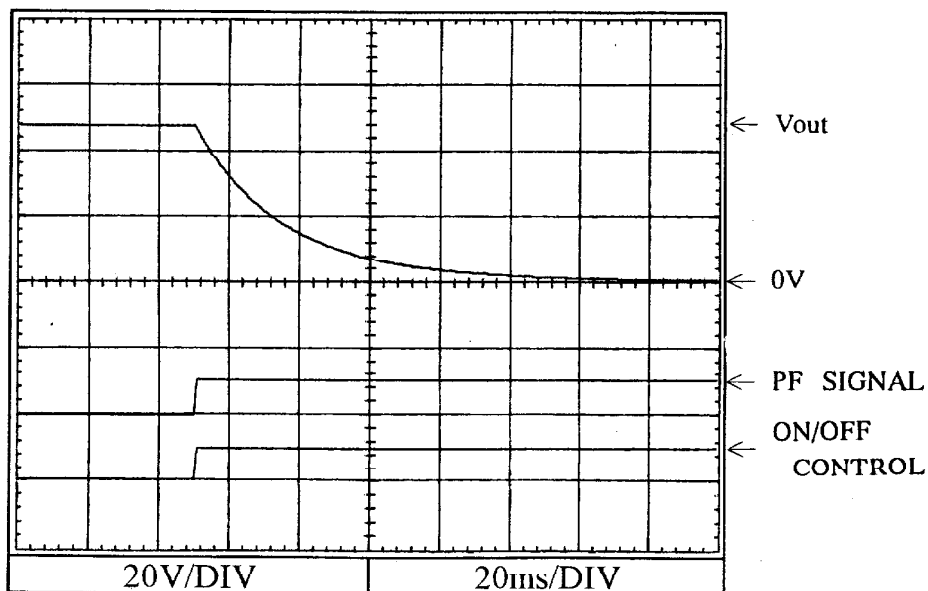

2.9 出力保持時間特性
Hold up time characteristics

Conditions Vin : 100VAC -----
 : 200VAC —————
 Ta : 25°C

24V

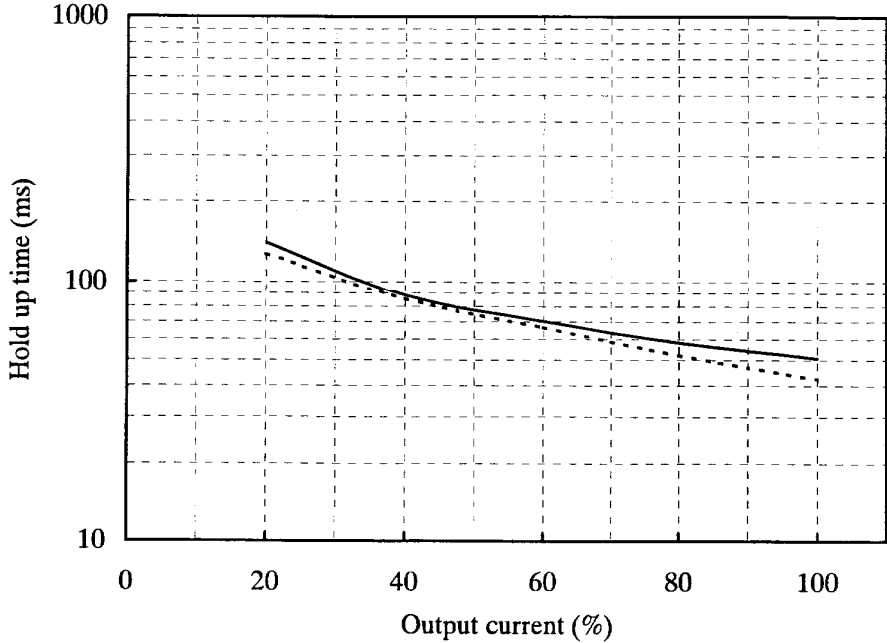

48V

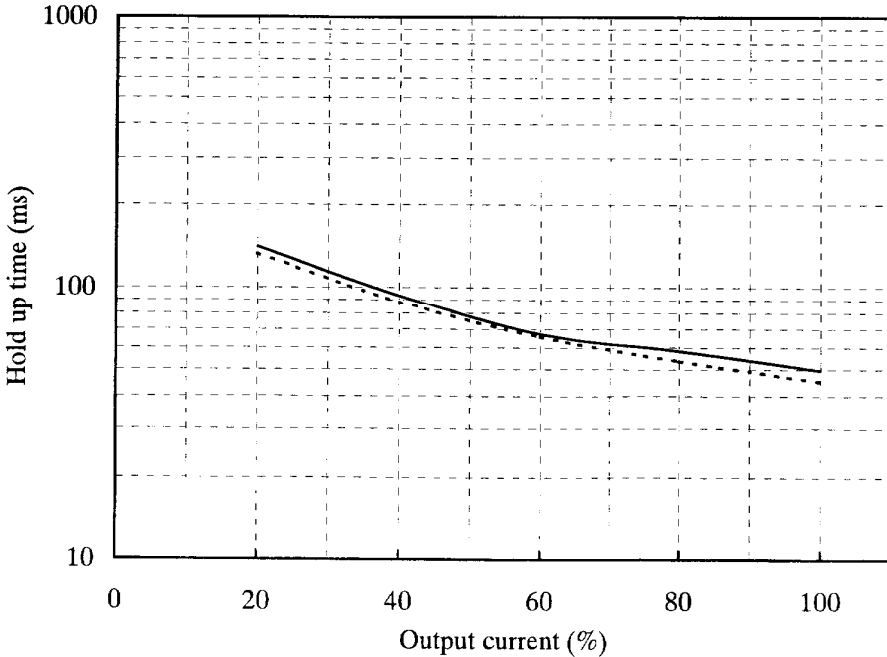

2.10 過渡応答 (入力急変) 特性
Dynamic line response characteristics

Conditions V_{in} : 85VAC \longleftrightarrow 132VAC(A)
170VAC \longleftrightarrow 265VAC(B)
 I_{out} : 100%
 T_a : 25°C

24V

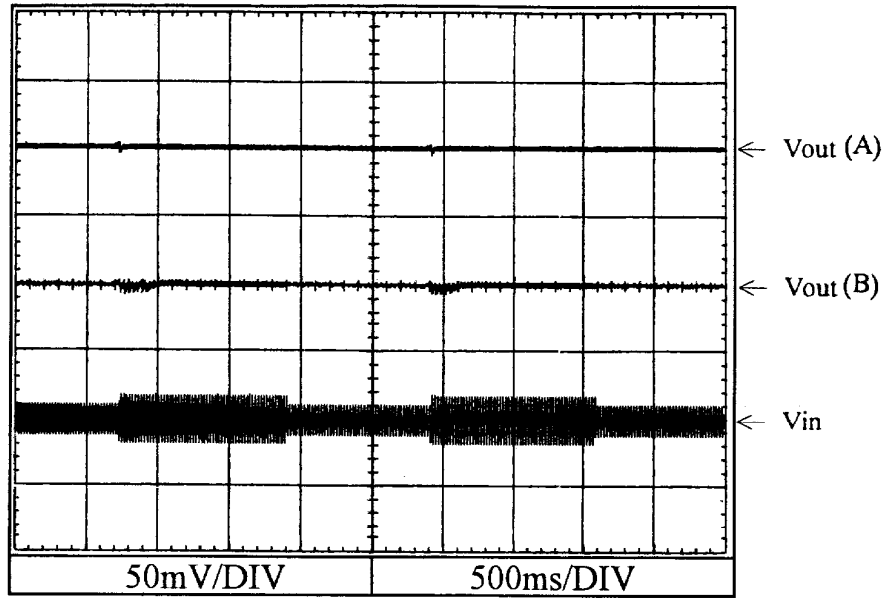

48V

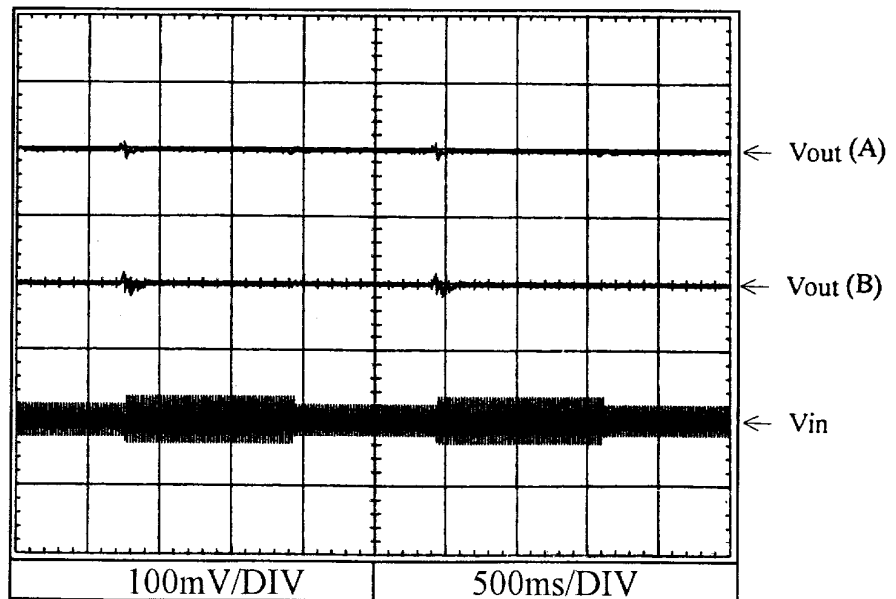

2.11 過渡応答 (負荷急変) 特性
Dynamic load response characteristics

Conditions Vin : 100VAC
Ta : 25°C

24V

f=100Hz

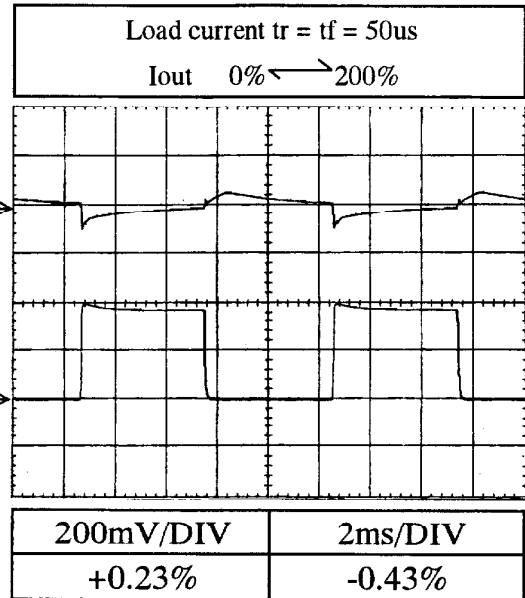
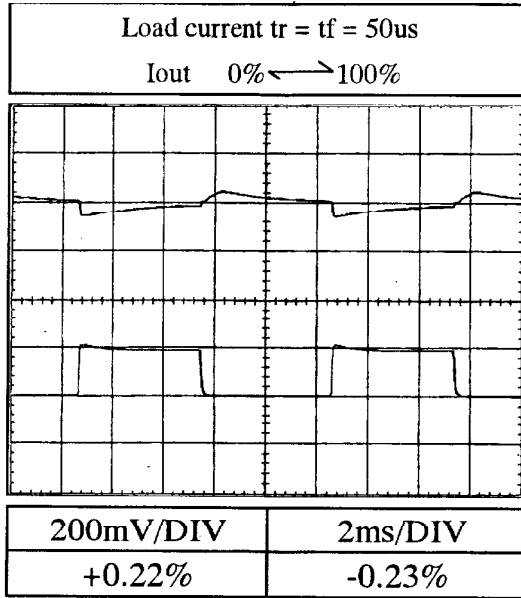

f=1kHz

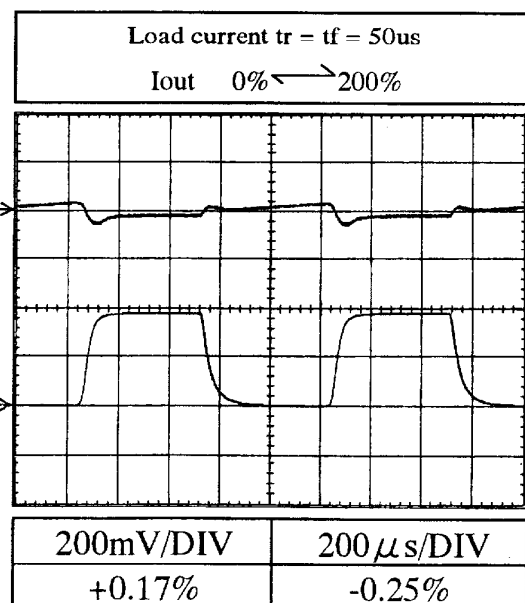
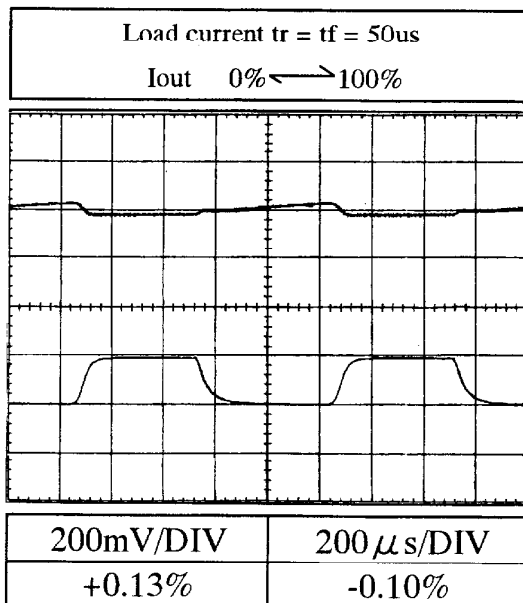

2.11 過渡応答 (負荷急変) 特性
Dynamic load response characteristics

Conditions Vin : 100VAC
Ta : 25°C

48V

f=100Hz

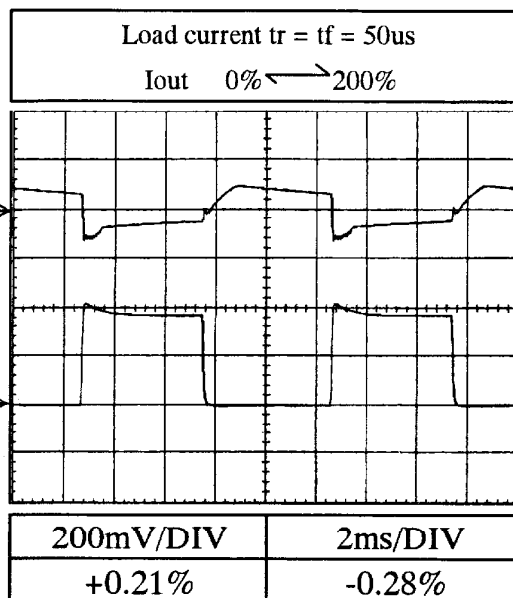
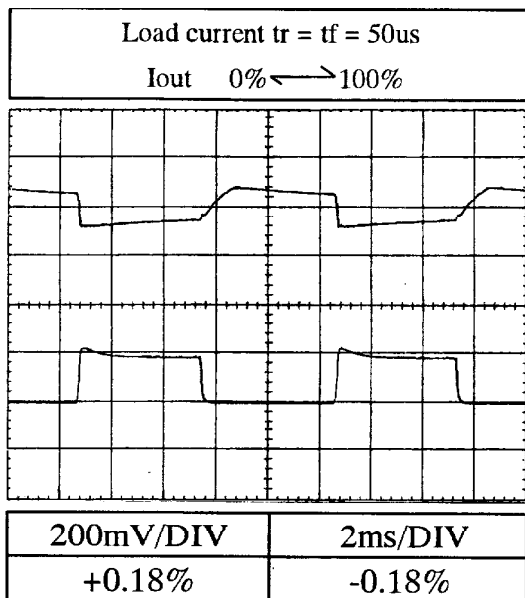

f=1kHz

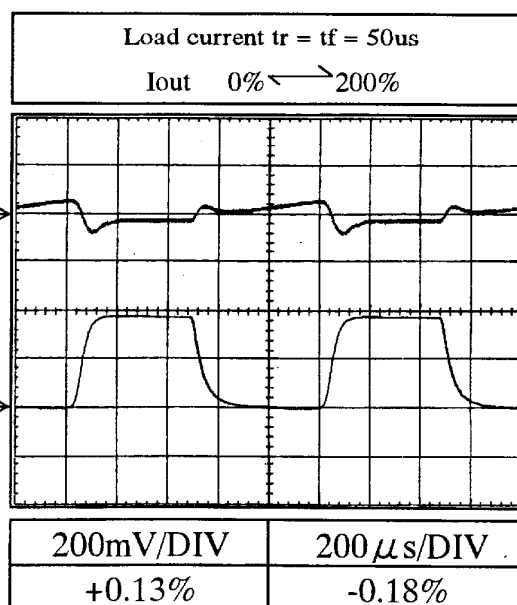
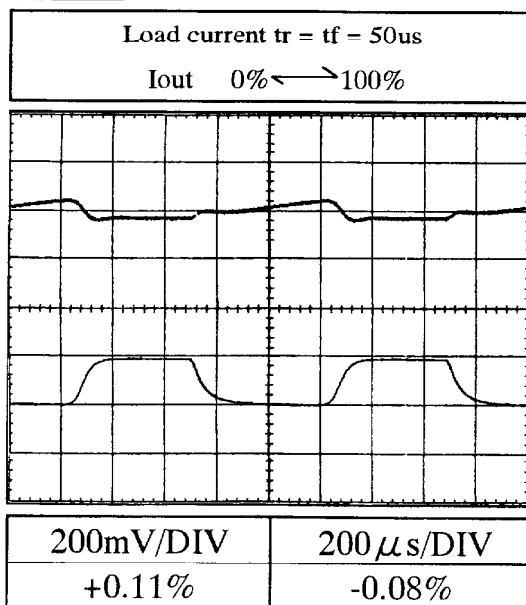

2.12 入力電圧瞬停特性

Response to brown out characteristics

Conditions V_{in} : 100VAC

I_{out} : 100%

T_a : 25°C

24V

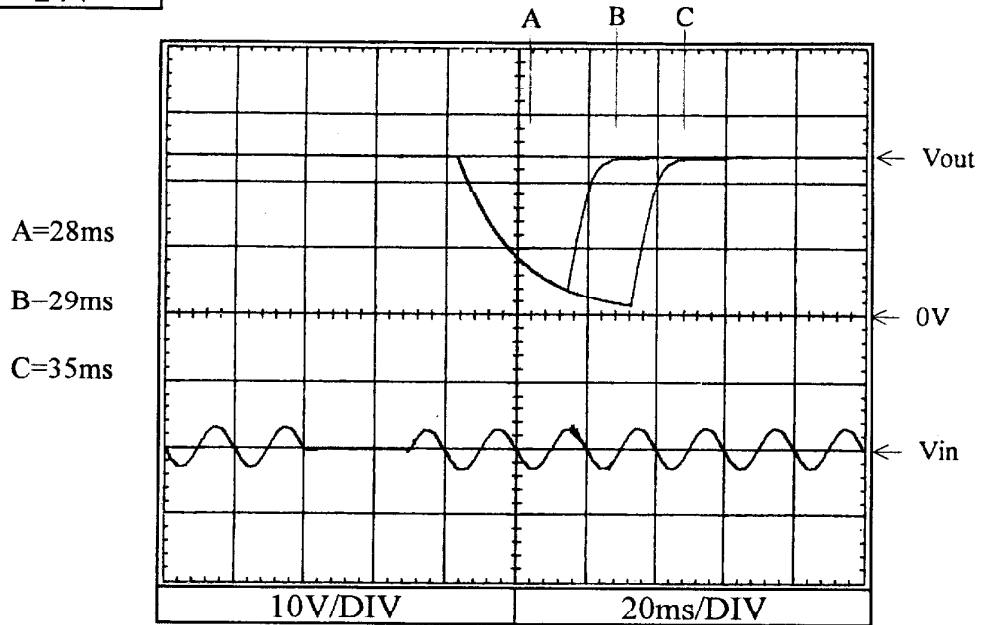

48V

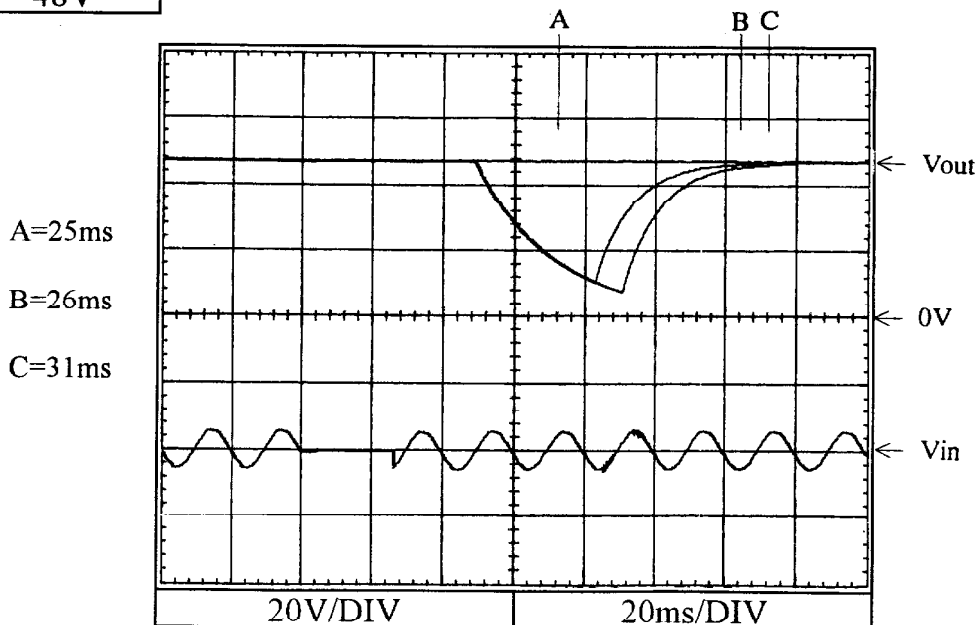

2.12 入力電圧瞬停特性
Response to brown out characteristics

Conditions V_{in} : 200VAC
 I_{out} : 100%
 T_a : 25°C

24V

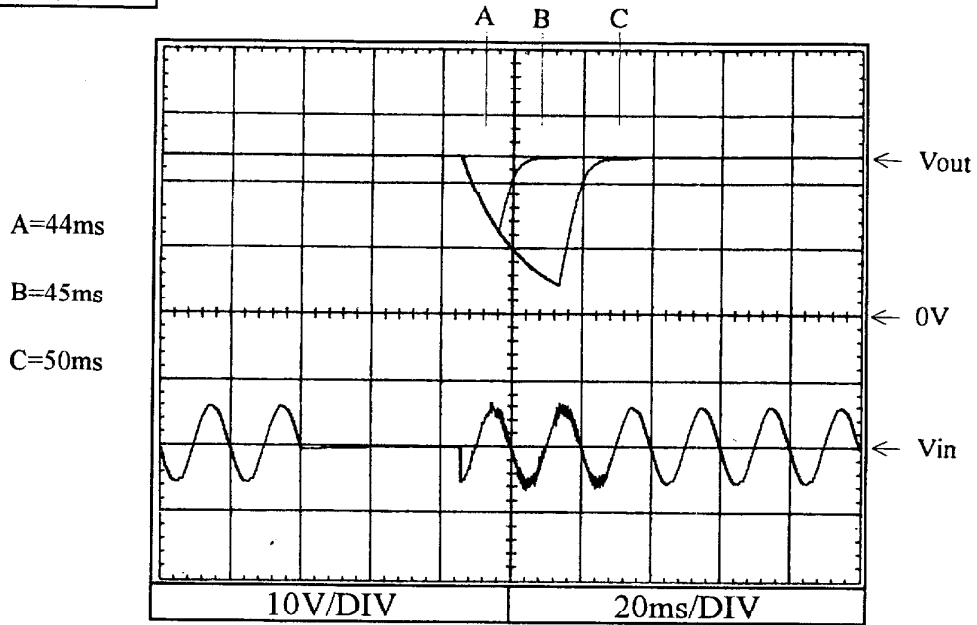

48V

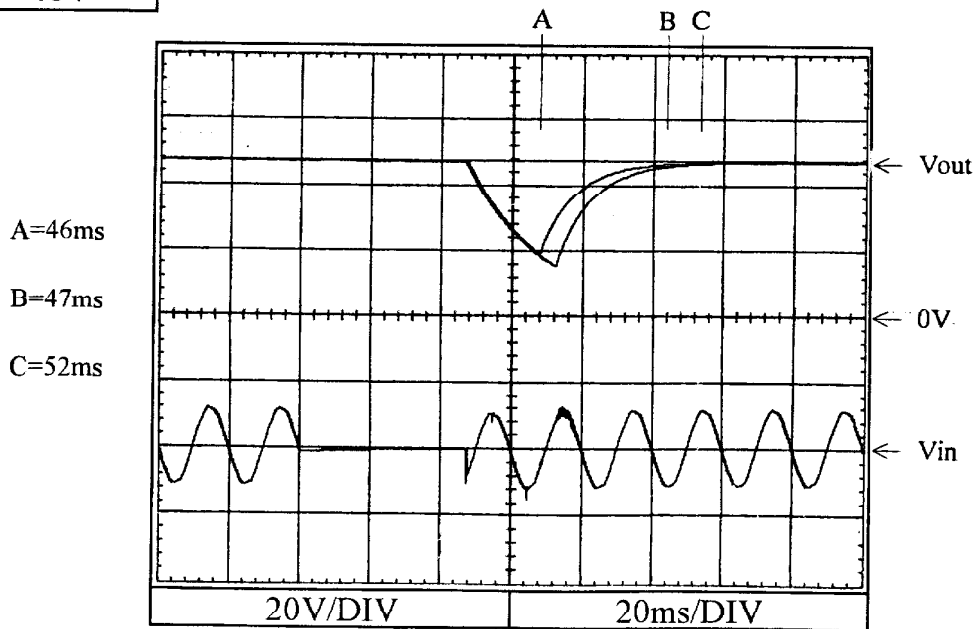

2.13 入力サージ電流 (突入電流) 特性
Inrush current waveform

Conditions Vin : 100VAC
Iout : 100%
Ta : 25°C

24V

Switch on phase angle
of input AC voltage
 $\phi = 0^\circ$

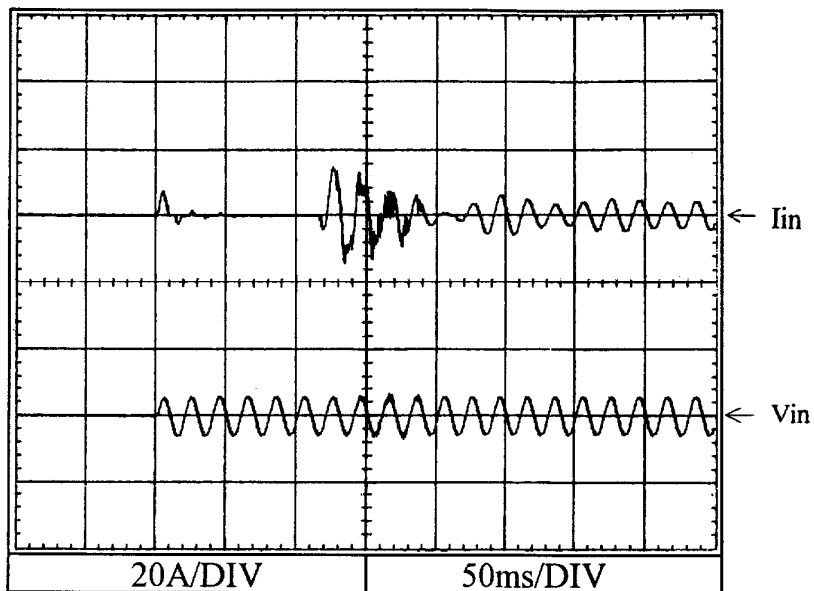

Switch on phase angle
of input AC voltage
 $\phi = 90^\circ$

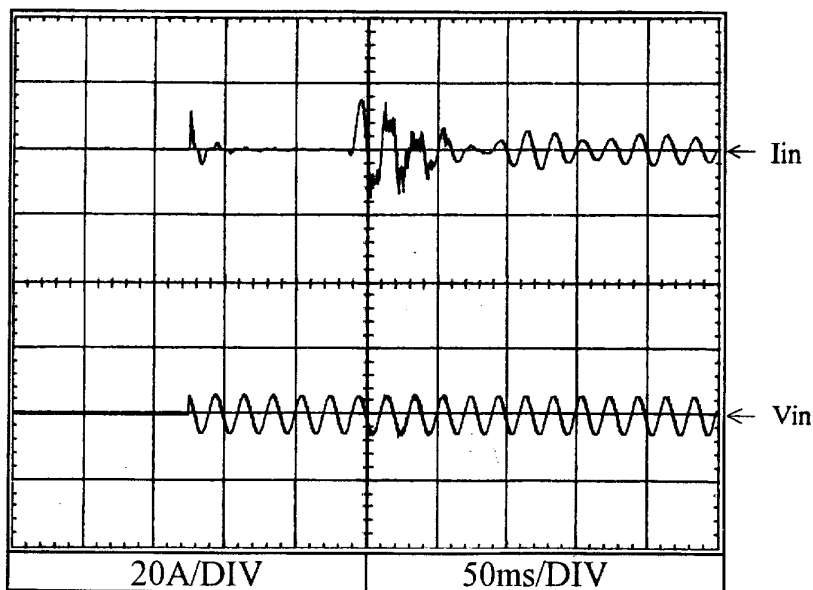

2.13 入力サージ電流 (突入電流) 特性
Inrush current waveform

Conditions V_{in} : 200VAC
 I_{out} : 100%
 T_a : 25°C

24V

Switch on phase angle
of input AC voltage
 $\phi = 0^\circ$

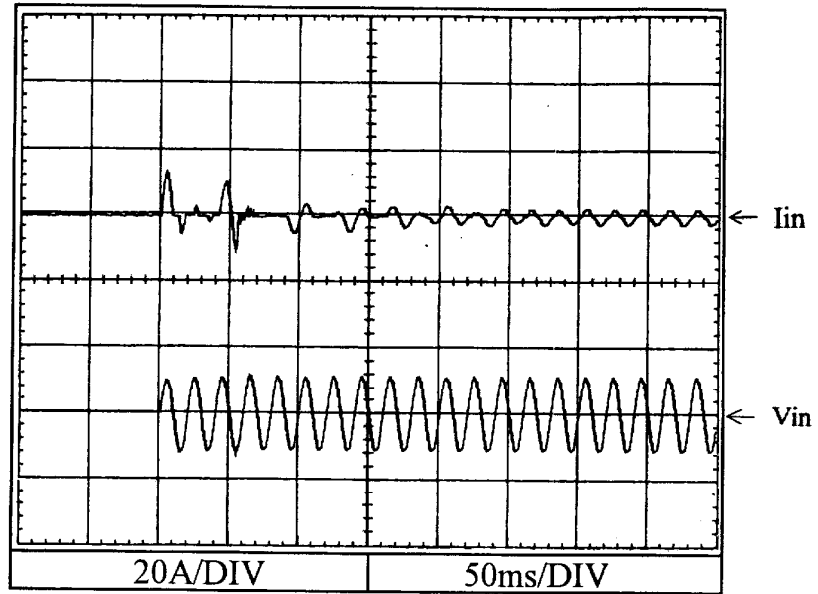

Switch on phase angle
of input AC voltage
 $\phi = 90^\circ$

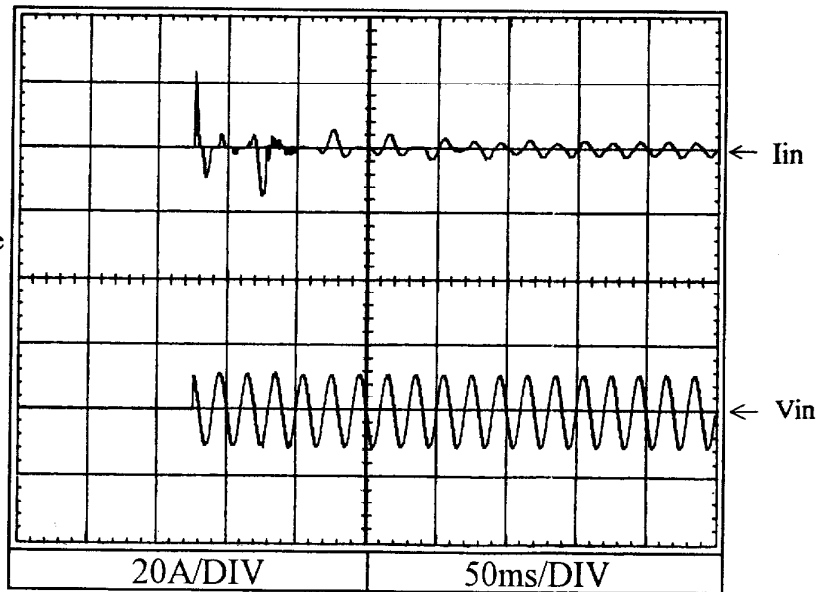

2.14 瞬停時突入電流特性
Inrush current characteristics

Conditions Iout : 0% -----
: 50% -----
: 100% ——
Ta : 25°C

24V

Vin : 100VAC

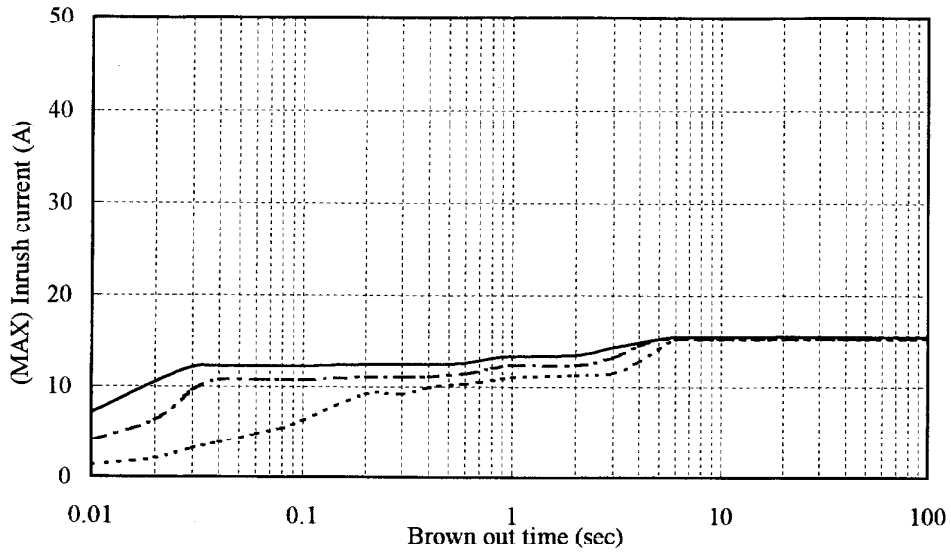

Vin : 200VAC

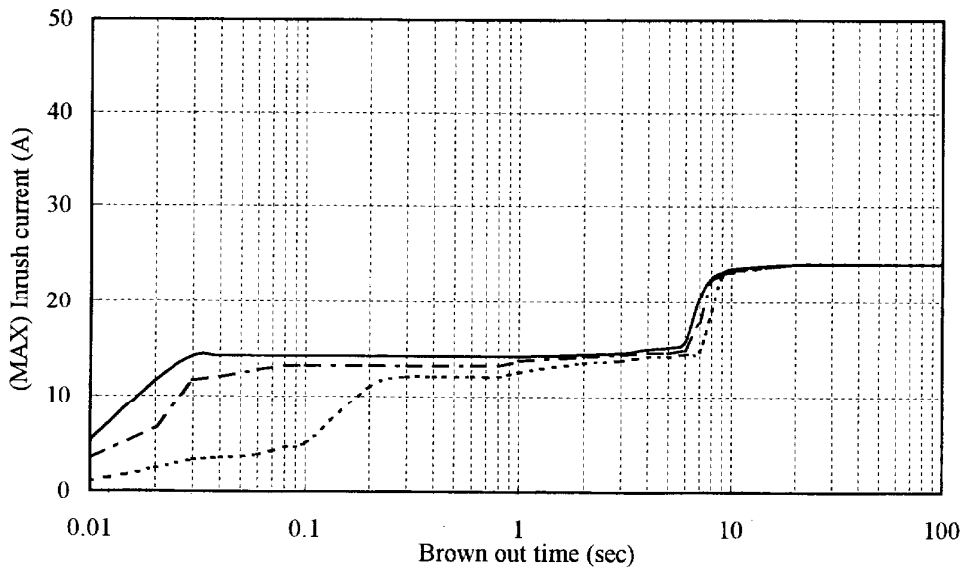

※ 上記値は、2次突入電流を含んだ値である。
Above data includes secondary inrush current.

2.15 入力電流波形
Input current waveform

24V

Conditions Vin : 100VAC
Iout : 100%
Ta : 25°C

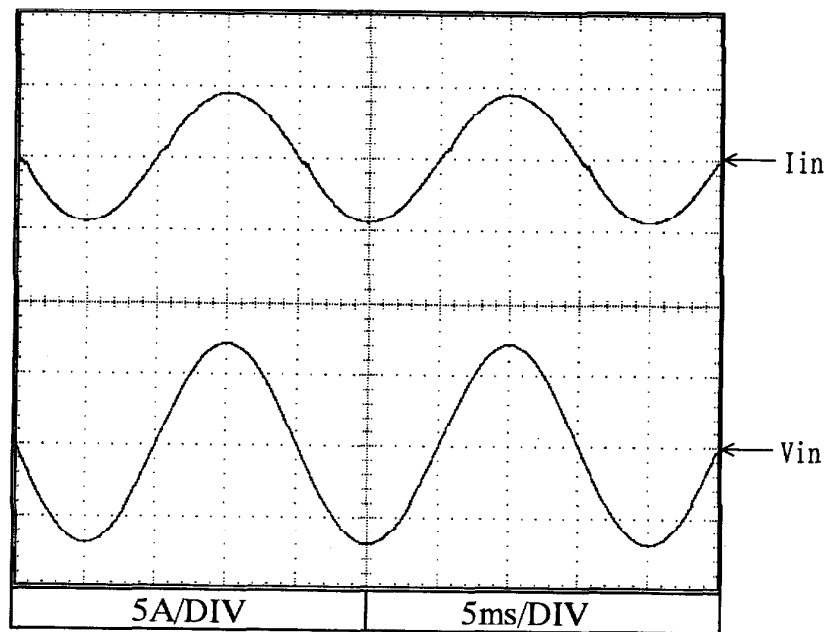

Conditions Vin : 200VAC
Iout : 100%
Ta : 25°C

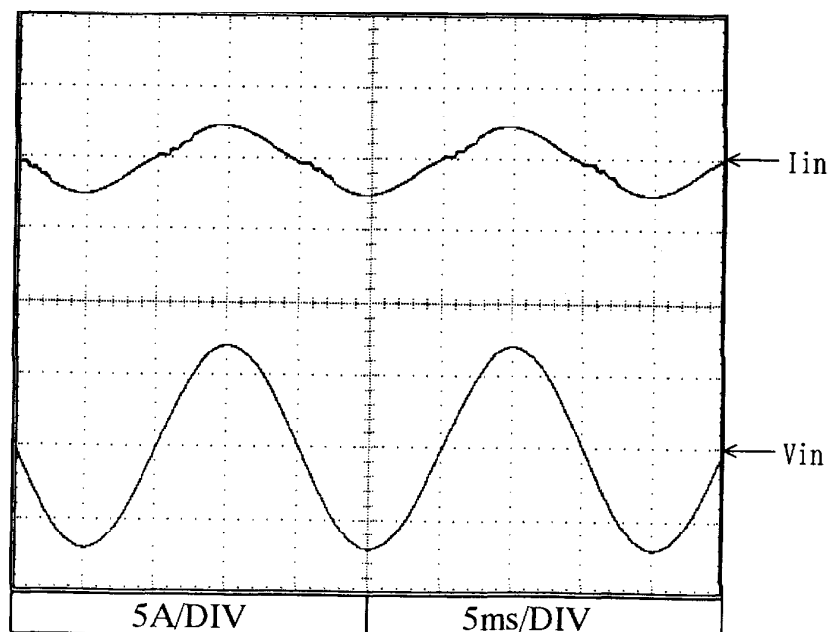

2.16 高調波成分
Input current harmonics

24V

Conditions Vin : 100VAC
Iout : 100%
Ta : 25°C

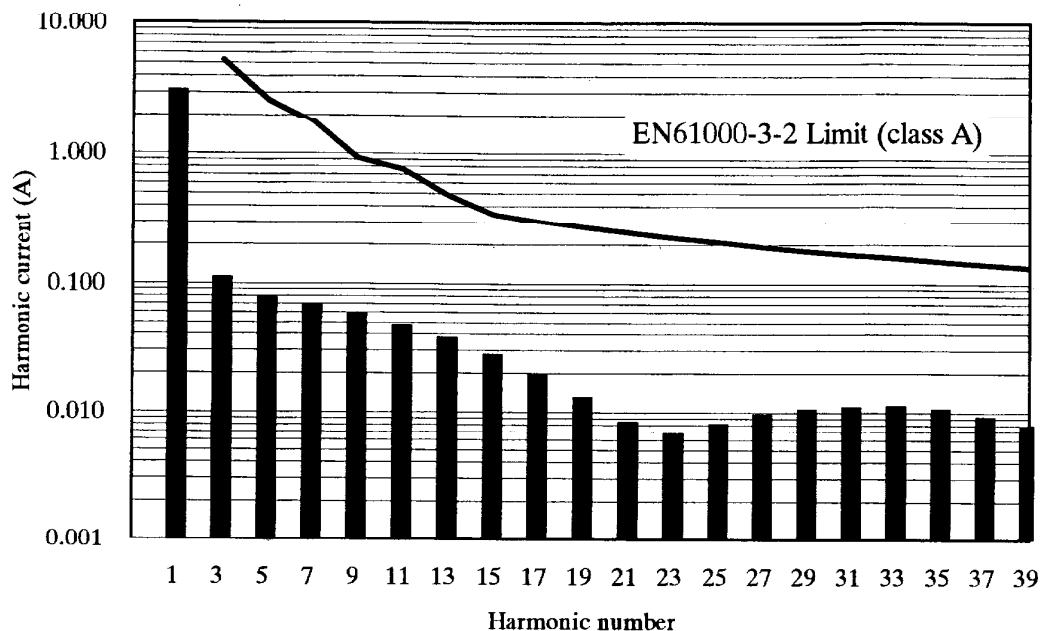

Conditions Vin : 230VAC
Iout : 100%
Ta : 25°C

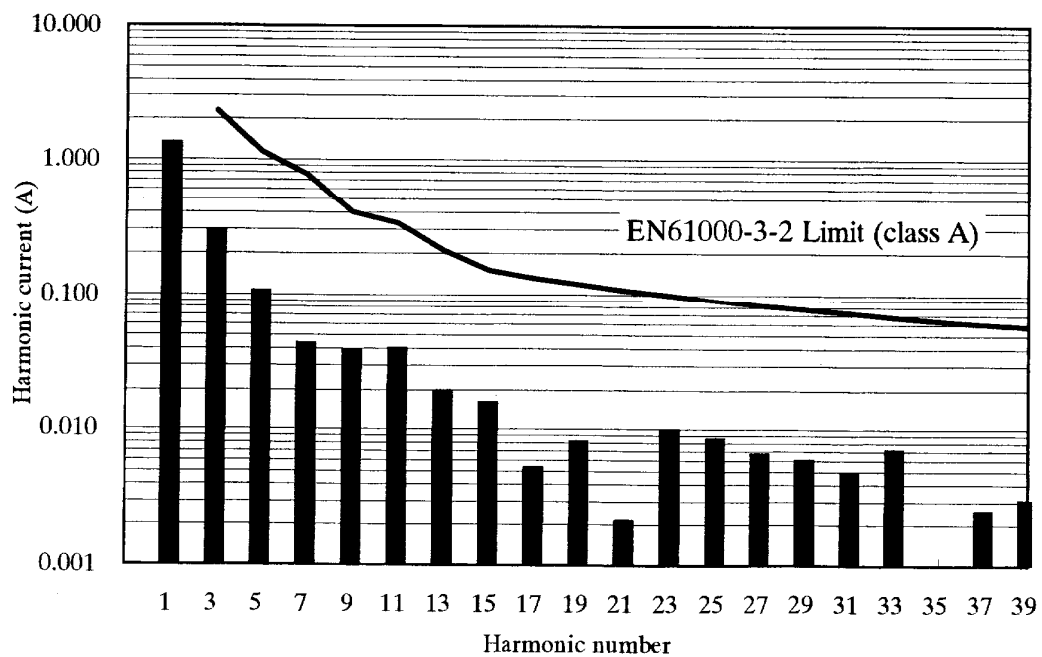

2.17 リーク電流特性
Leakage current characteristics

Conditions Iout : 0% -----
 : 100% —————
 Ta : 25°C
 f : 50Hz
Equipment used : MODEL 229-2 (Simpson)

24 V

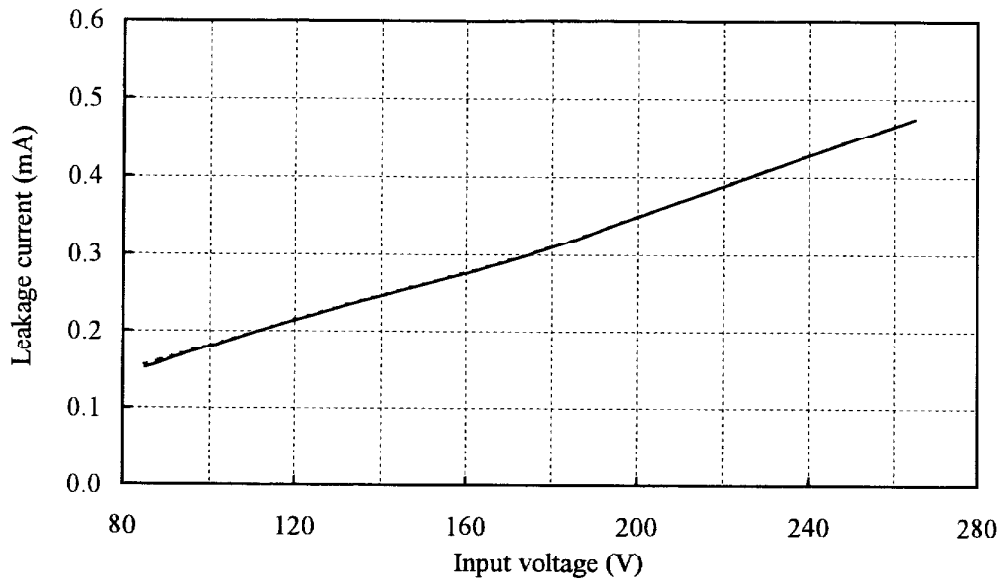

48 V

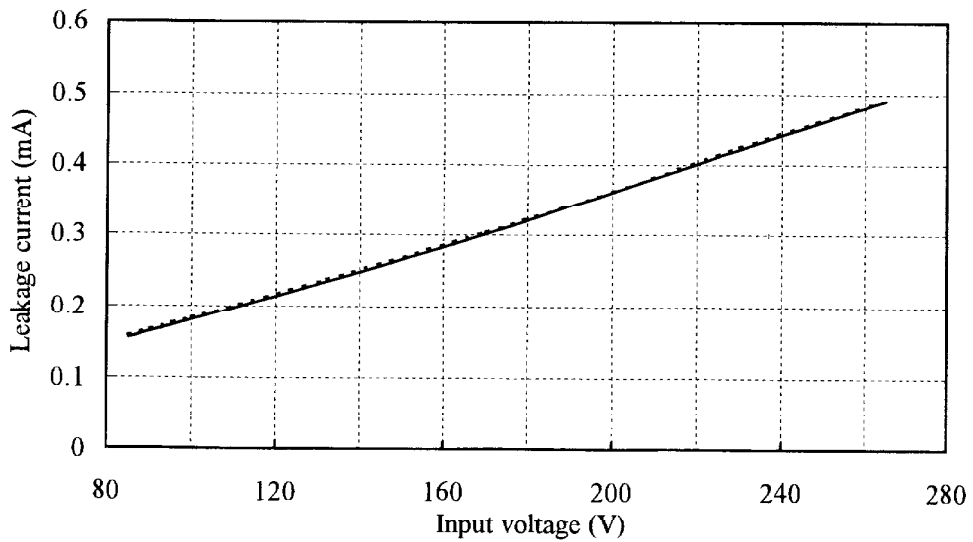

2.17 リーク電流特性
Leakage current characteristics

Conditions Iout : 0% -----
 : 100% —————
 Ta : 25°C
 f : 50Hz
Equipment used : TYPE3226 (YOKOGAWA)

24 V

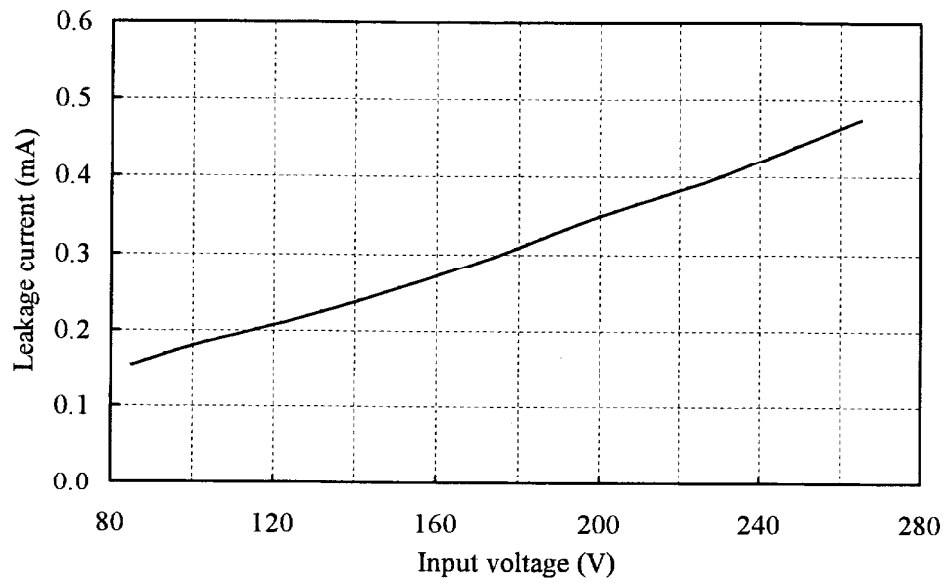

48 V

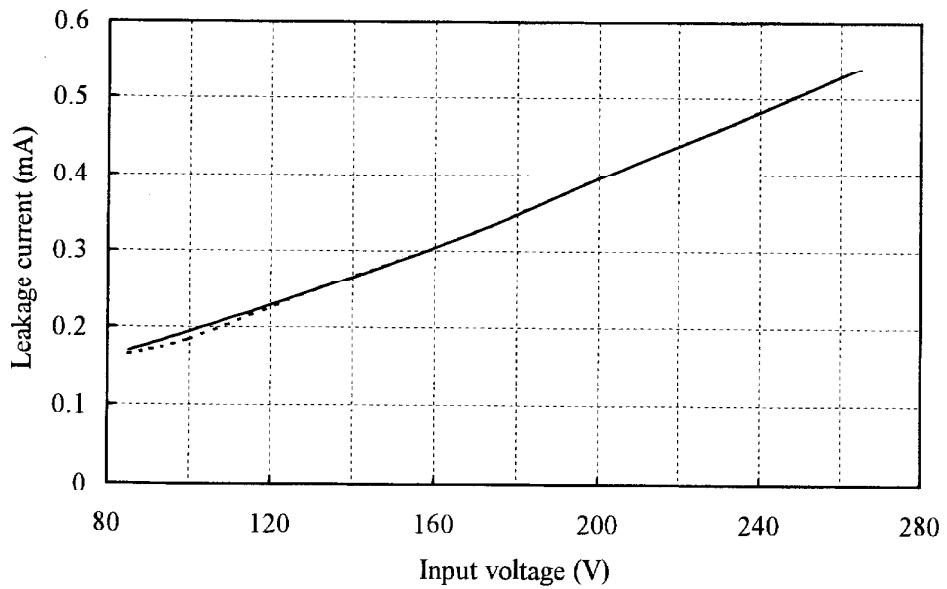

2.18 出力リップル、ノイズ波形
Output ripple and noise waveform

Conditions Vin : 100VAC
Iout : 100%
Ta : 25°C

NORMAL MODE

24V

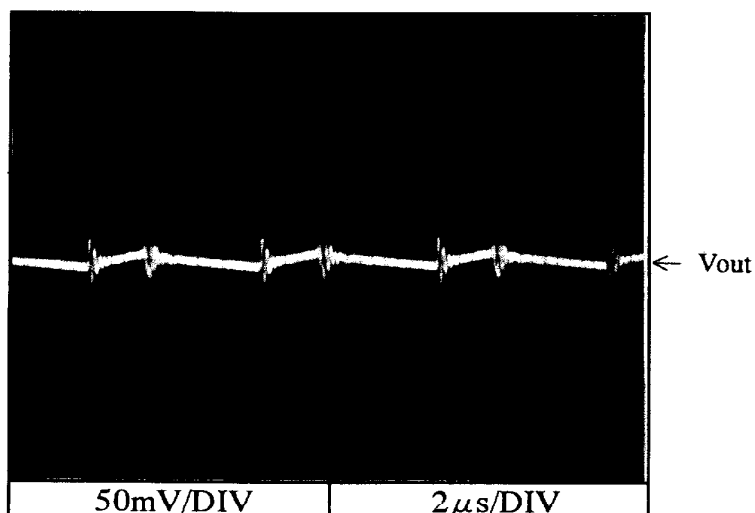

48V

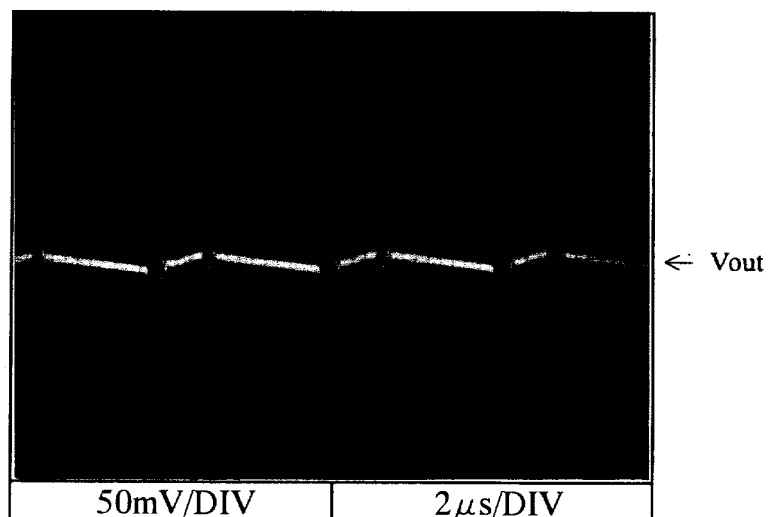

2.18 出力リップル、ノイズ波形
Output ripple and noise waveform

Conditions Vin : 100VAC
Iout : 100%
Ta : 25°C

NORMAL + COMMON MODE

24V

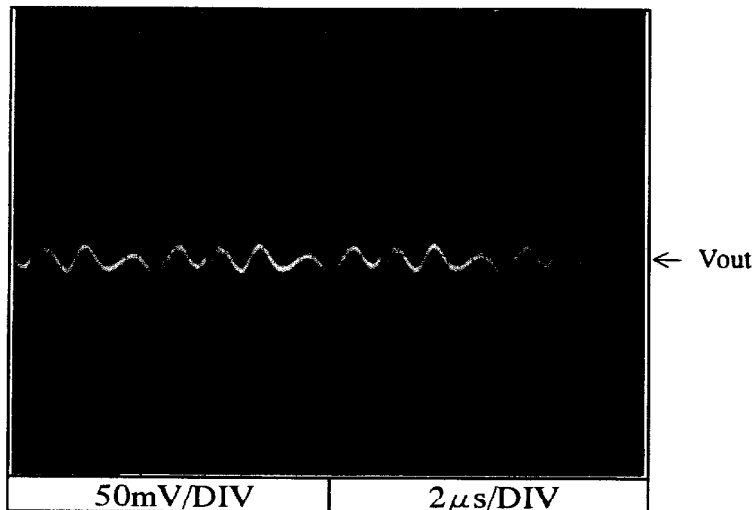

48V

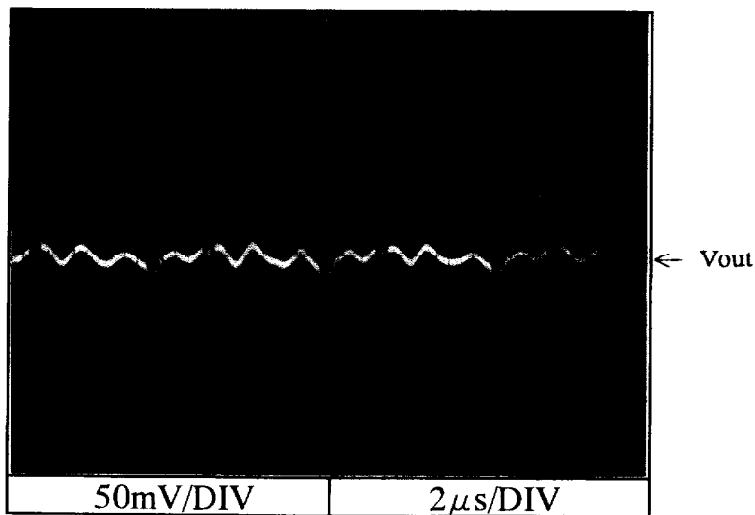

2.19 EMI 特性

Electro-Magnetic Interference characteristics

雑音端子電圧

Conducted Emission

24V

Conditions Vin : 100VAC
Iout : 100%

Point A (184kHz)		
Ref.	VCCI-Limit (dBuV)	Measure (dBuV)
QP	79.0	43.5
AV	66.0	43.2

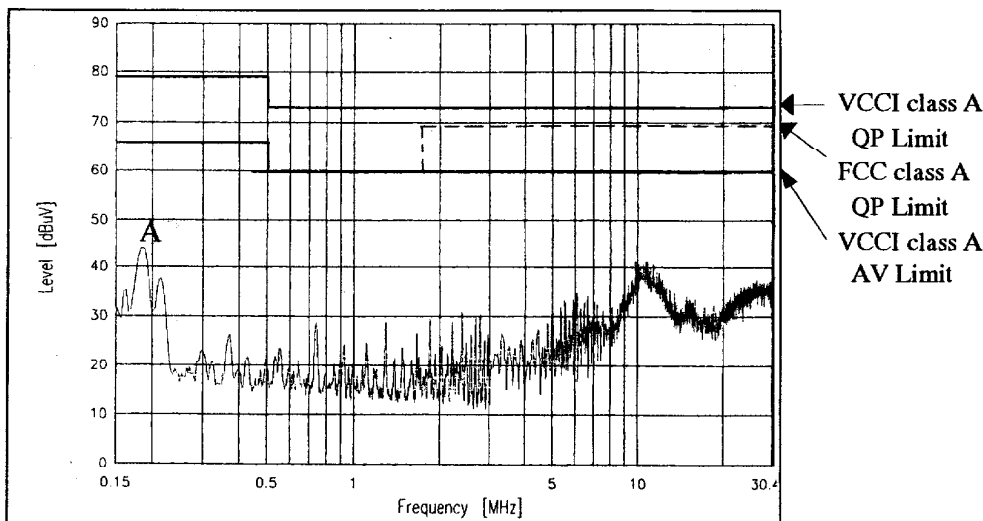

Phase : L

48V

Conditions Vin : 100VAC
Iout : 100%

Point B (182kHz)		
Ref.	VCCI-Limit (dBuV)	Measure (dBuV)
QP	79.0	40.6
AV	66.0	40.3

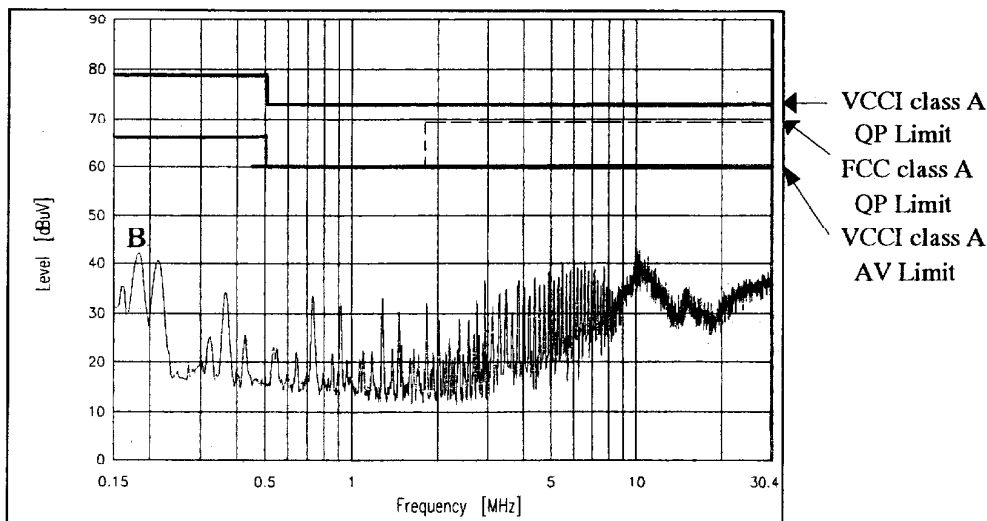

Phase : N

EN55011-A,EN55022-Aの限界値はVCCI class Aの限界値と同じ
Limits of EN55011-A,EN55022-A are same as its VCCI class A.

2.19 EMI 特性

Electro-Magnetic Interference characteristics

雑音電界強度
Radiated Emission

Conditions Vin : 100VAC
Iout : 100%

24V

HORIZONTAL:

Point A (150.3MHz)		
Ref.	VCCI-Limit (dBuV/m)	Measure (dBuV/m)
QP	50.0	41.8

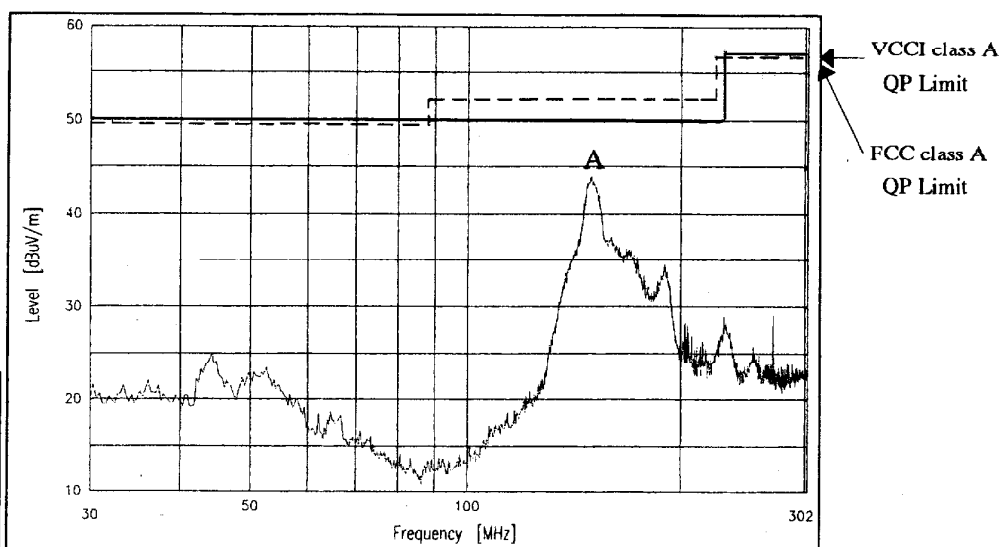

VERTICAL:

Point B (147.4MHz)		
Ref.	VCCI-Limit (dBuV/m)	Measure (dBuV/m)
QP	50	41.7

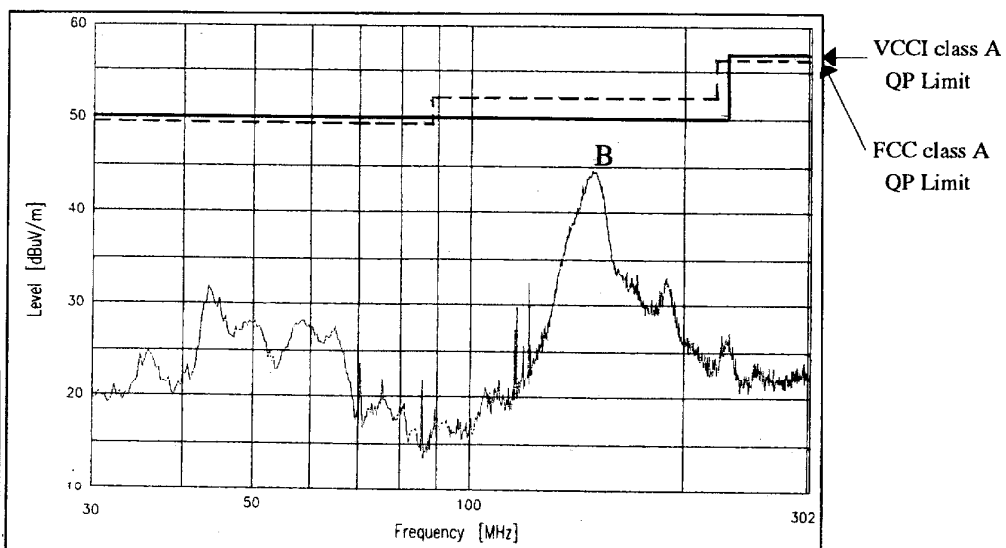

EN55011-A,EN55022-Aの限界値はVCCI class Aの限界値と同じ
Limits of EN55011-A,EN55022-A are same as its VCCI class A.

2.19 EMI 特性

Electro-Magnetic Interference characteristics

雑音電界強度
Radiated Emission

Conditions Vin : 100VAC
Iout : 100%

48V

HORIZONTAL:

Point A (148.8MHz)		
Ref.	VCCI-Limit (dBuV/m)	Measure (dBuV/m)
QP	50.0	42.5

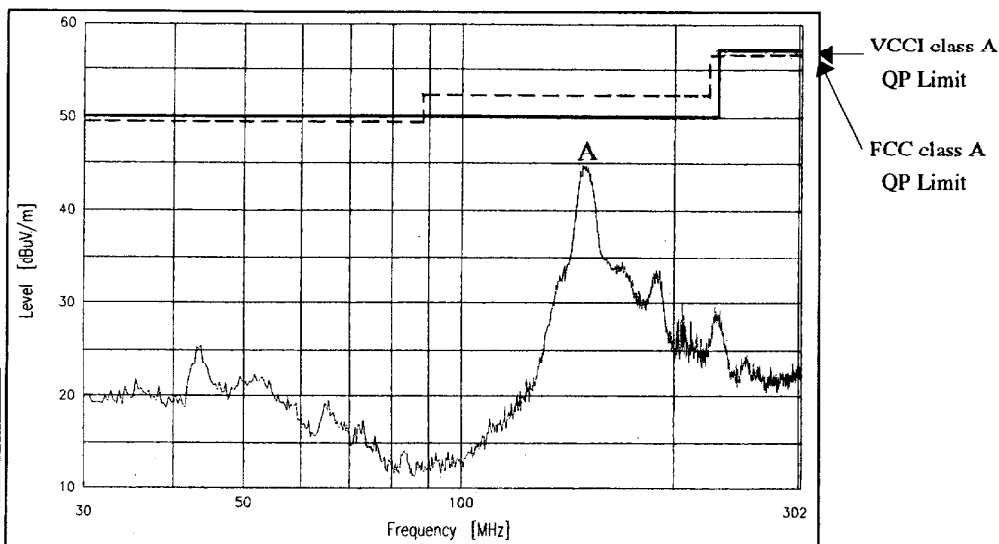

VERTICAL:

Point B (148.5MHz)		
Ref.	VCCI-Limit (dBuV/m)	Measure (dBuV/m)
QP	50.0	41.8

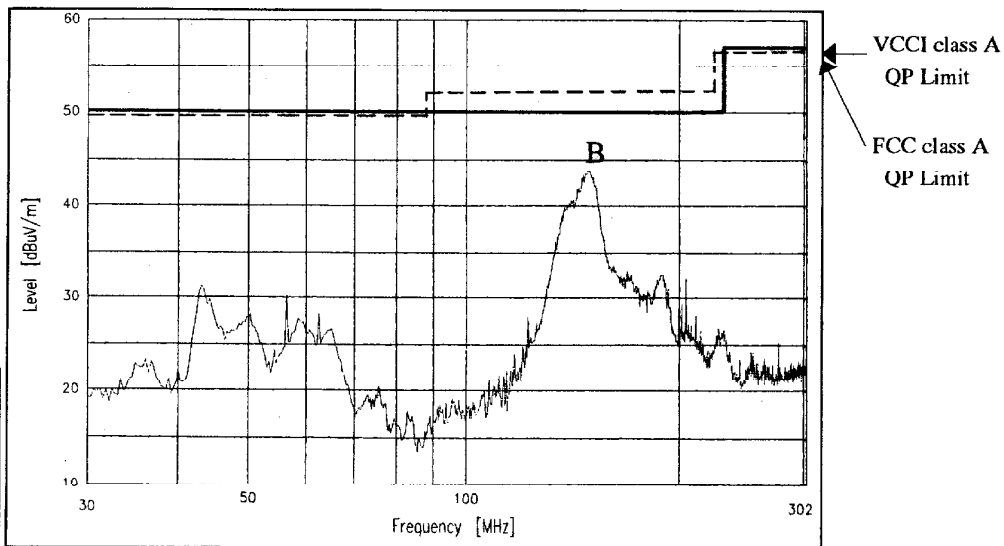

EN55011-A,EN55022-Aの限界値はVCCI class Aの限界値と同じ
Limits of EN55011-A,EN55022-A are same as its VCCI class A.