

KWS5A

EVALUATION DATA

型式データ

INDEX

PAGE

1. 測定方法 Evaluation Method	
1-1. 測定回路 Circuit used for determination	
測定回路1 Circuit 1 used for determination.....	4
静特性 Steady state data	
通電ドリフト特性 Warm up voltage drift characteristics	
出力保持時間特性 Hold up time characteristics	
出力立ち上がり特性 Output rise characteristics	
出力立ち下がり特性 Output fall characteristics	
過電流保護特性 Over current protection (OCP) characteristics	
入力電圧瞬停特性 Response to brown out characteristics	
入力電流波形 Input current waveform	
測定回路2 Circuit 2 used for determination	4
過渡応答(負荷急変)特性 Dynamic load response characteristics	
測定回路3 Circuit 3 used for determination	5
入力サージ電流(突入電流)波形 Inrush current waveform	
測定回路4 Circuit 4 used for determination	5
過電圧保護特性 Over voltage protection (OVP) characteristics	
測定回路5 Circuit 5 used for determination	6
出力リップル、ノイズ波形 Output ripple and noise waveform	
測定回路6 Circuit 6 used for determination	6
EMI特性 Electro-Magnetic Interference characteristics	
雑音電界強度(放射ノイズ) Radiated Emission	
測定構成 Configuration used for determination	7
EMI特性 Electro-Magnetic Interference characteristics	
(a) 雑音端子電圧(帰還ノイズ) Conducted Emission	
(b) 雑音電界強度(放射ノイズ) Radiated Emission	
1-2. 使用測定機器 List of equipment used	8
1-3. 評価負荷条件 Load conditions	8

2. 特性データ Characteristics

2-1. 静特性 Steady state data

- (1) 入力・負荷・温度変動／出力起動・遮断電圧

Regulation - line and load, Temperature drift / Start up voltage and Drop out voltage … 9

- (2) リップルノイズ電圧対入力電圧 Ripple noise voltage vs. Input voltage …… 10

- (3) 効率・力率対出力電流 Efficiency and Power factor vs. Output current …… 11

- (4) 入力電力対出力電流 Input power vs. Output current …… 12

- (5) 入力電流対出力電流 Input current vs. Output current …… 13

2-2. 通電ドリフト特性 Warm up voltage drift characteristics …… 14

2-3. 出力保持時間特性 Hold up time characteristics …… 14

2-4. 出力立ち上がり特性 Output rise characteristics …… 15~17

2-5. 出力立ち下がり特性 Output fall characteristics …… 18~20

2-6. 過電流保護特性 Over current protection (OCP) characteristics …… 21

2-7. 過電圧保護特性 Over voltage protection (OVP) characteristics …… 21

2-8. 過渡応答(負荷急変)特性 Dynamic load response characteristics …… 22

2-9. 入力電圧瞬停特性 Response to brown out characteristics …… 23~25

2-10. 入力サージ電流(突入電流)波形 Inrush current waveform …… 26

2-11. 入力電流波形 Input current waveform …… 27

2-12. 出力リップル、ノイズ波形 Output ripple and noise waveform …… 28

2-13. EMI特性 Electro-Magnetic Interference characteristics …… 29~36

使用記号 Terminology used

定義 Definition

V_{in} …… 入力電圧 Input voltage

V_{out} …… 出力電圧 Output voltage

I_{in} …… 入力電流 Input current

I_{out} …… 出力電流 Output current

T_a …… 周囲温度 Ambient temperature

f …… 周波数 Frequency

※ 当社測定条件における結果であり、参考値としてお考え願います。

Test results are reference data based on our measurement condition.

1. 測定方法 Evaluation Method

1-1. 算出方法 Calculating Method

測定回路1 Circuit 1 used for determination

- 静特性 Steady state data
- 通電ドリフト特性 Warm up voltage drift characteristics
- 出力保持時間特性 Hold up time characteristics
- 出力立ち上がり特性 Output rise characteristics
- 出力立ち下がり特性 Output fall characteristics
- 過電流保護特性 Over current protection (OCP) characteristics
- 入力電圧瞬停特性 Response to brown out characteristics
- 入力電流波形 Input current waveform

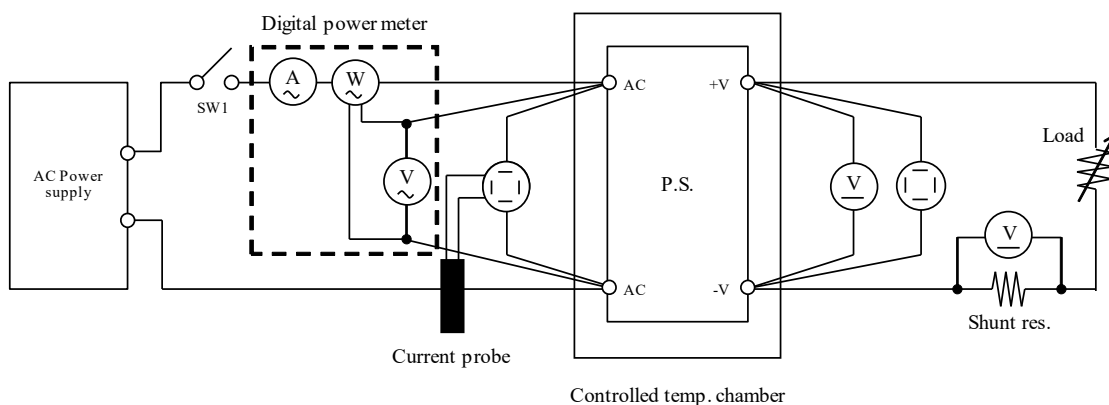

測定回路2 Circuit 2 used for determination

- 過渡応答(負荷急変)特性 Dynamic load response characteristics

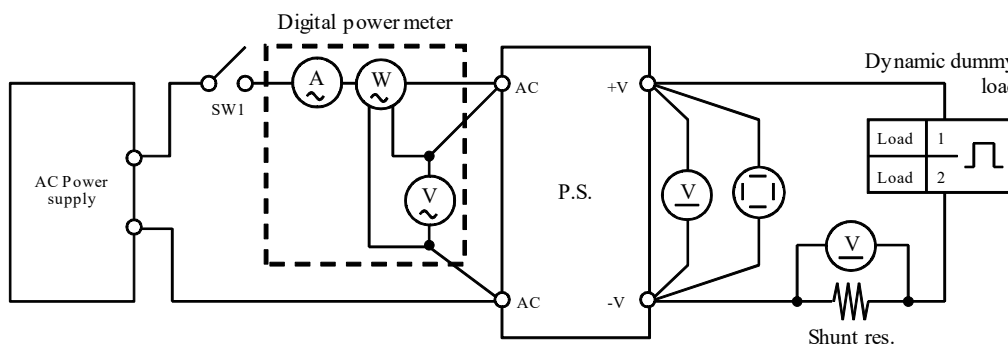

Output current waveform
Iout 50% <==> 100%

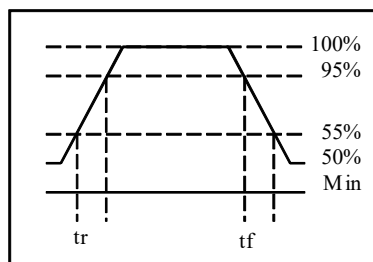

測定回路3 Circuit 3 used for determination

- 入力サージ電流 (突入電流) 波形 Inrush current waveform

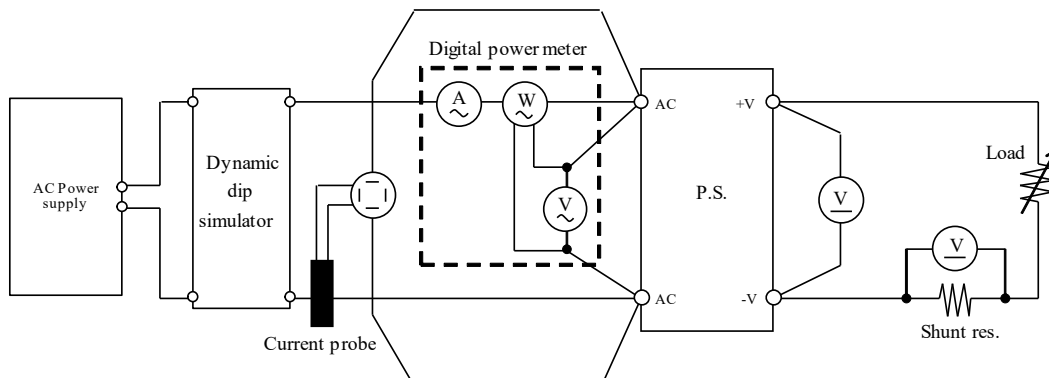

測定回路4 Circuit 4 used for determination

- 過電圧保護特性 Over voltage protection (OVP) characteristics

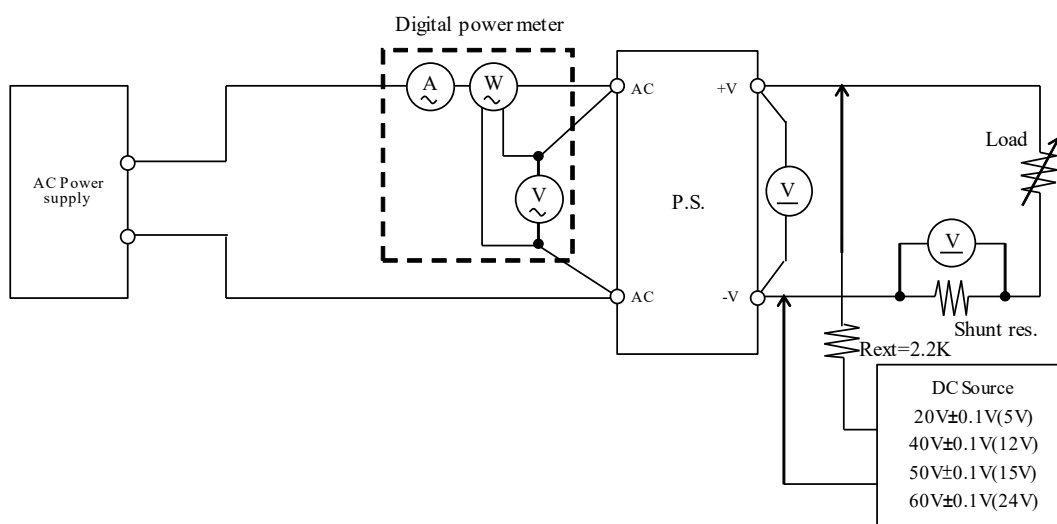

測定回路5 Circuit 5 used for determination

- 出力リップル、ノイズ波形 Output ripple and noise waveform

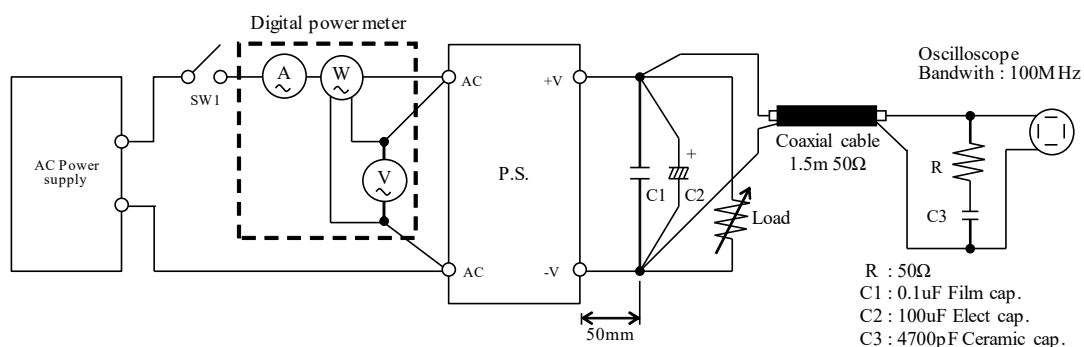

測定回路6 Circuit 6 used for determination

- EMI特性 Electro-Magnetic Interference characteristics
- 雑音電界強度(放射ノイズ) Radiated Emission

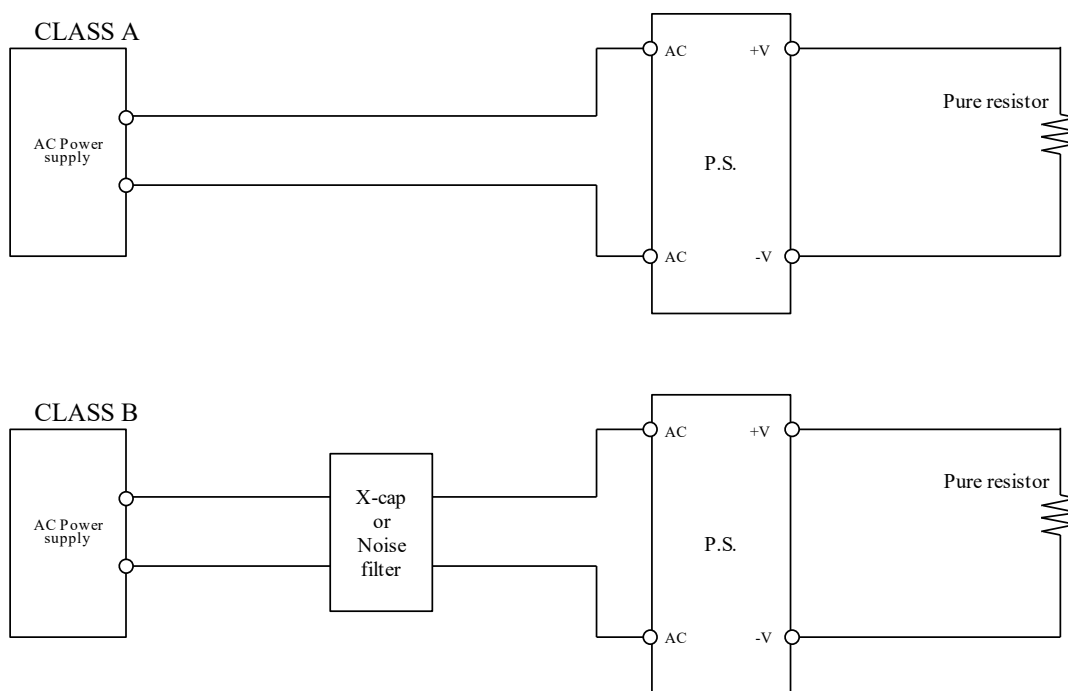

推奨 X-コンデンサ X-cap recommended :
 ECQU3A104MG(PANASONIC) or CTX104K310VP10 (CHENG TUNG).
 推奨ノイズフィルタ Noise filter recommended :
 RSEG-2001 (TDK-Lambda).

測定構成 Configuration used for determination

- EMI特性 Electro-Magnetic Interference characteristics

(a) 雑音端子電圧(帰還ノイズ) Conducted Emission

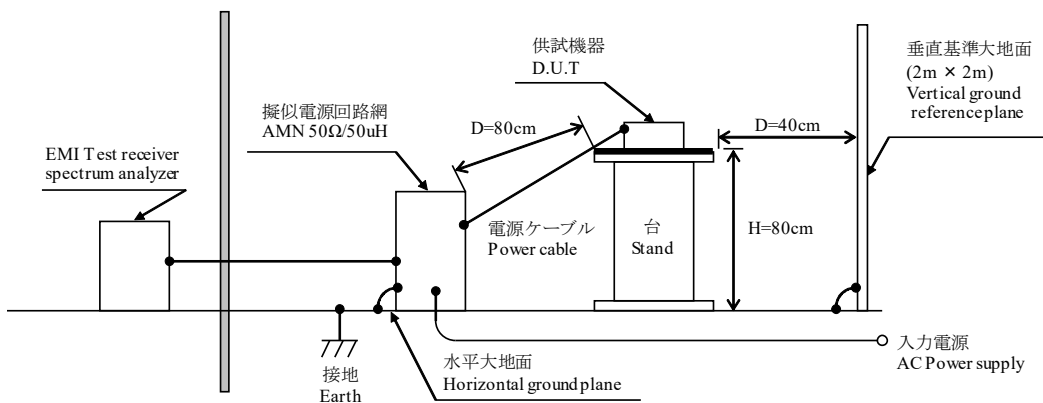

(b) 雑音電界強度(放射ノイズ) Radiated Emission

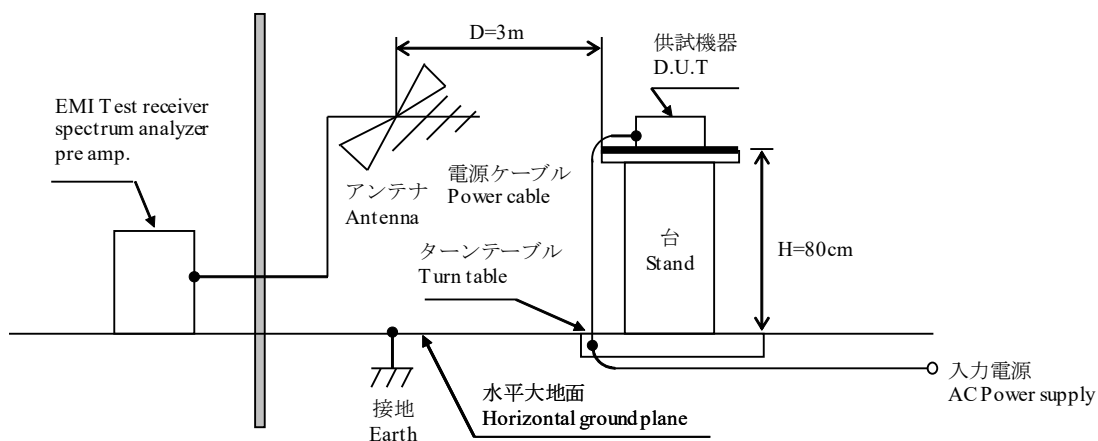

1-2. 使用測定機器 List of equipment used

	EQUIPMENT USED	MANUFACTURER	MODEL NO.
1	DIGITAL STORAGE OSCILLOSCOPE	LeCroy	LT345
2	DIGITAL STORAGE OSCILLOSCOPE	TeKtronix	TDS3014B
3	DIGITAL MULTIMETER	AGILENT	34970A
4	DIGITAL POWER METER	YOKOGAWA ELECT.	WT210
5	CURRENT PROBE	TeKtronix	TPC 312
6	CURRENT AMP	TeKtronix	TCPA300
7	DYNAMIC DUMMY LOAD	PRODIGIT	3311C
8	CVCF	CHROMA	6530
9	CVCF	KIKUSUI	PCR2000L / PCR2000W
10	S.D	TAI YEESH SING	TRZ SO-45
11	CONTROLLED TEMP. CHAMBER	ESPEC	SU-261 / SU-262
12	EMI TEST RECEIVER / SPECTRUM ANALYZER	ROHDE & SCHWARZ	ESCS 30
13	LISN	ROHDE & SCHWARZ	ESH3-Z5
14	LISN	ROHDE & SCHWARZ	ENV216
15	COAXIAL CABLE	Harbour	RG-400
16	EMI TEST RECEIVER / SPECTRUM ANALYZER	ROHDE & SCHWARZ	ESC17
17	ANTENNA	Schaffner	CBL6112B
18	Coaxial Cable	Suhner	SF104 / SF106
19	Pre-Amplifier	QuieTek	AP-025C
20	DUMMY LOAD	FUTABA	GR-25 SIRIES

1-3. 評価負荷条件 Load conditions

※ 入力電圧が100VAC以下の場合、下記のとおり出力デレーティングが必要です。

Output derating is needed when input voltage is 100VAC or less.

Output voltage : 5V, 12V, 15V, 24V

V _{in}	I _{out} : Full load	5V	12V	15V	24V
100 - 265VAC	100%	1.000A	0.450A	0.350A	0.220A
85VAC	90%	0.900A	0.405A	0.315A	0.198A

2. 特性データ Characteristics

2-1. 静特性 Steady state data

(1) 入力・負荷・温度変動／出力起動・遮断電圧

Regulation - line and load, Temperature drift / Start up voltage and Drop out voltage

5V		1. Regulation - line and load				Condition Ta : 25 °C	
Iout \ Vin	85VAC	100VAC	200VAC	265VAC	Line regulation		
0%	4.988V	4.993V	4.989V	4.991V	5mV	0.100%	
50%	4.990V	4.990V	4.990V	4.989V	1mV	0.020%	
Full load	4.989V	4.988V	4.988V	4.988V	1mV	0.020%	
Load regulation	2mV	5mV	2mV	3mV			
	0.040%	0.100%	0.040%	0.060%			
		2. Temperature drift				Conditions Vin : 100 VAC Iout : Full load	
Ta	-10°C	+25°C	+55°C	Temperature stability			
Vout	4.992V	4.988V	4.980V	12mV	0.240%		
		3. Start up voltage and Drop out voltage				Conditions Ta : 25 °C Iout : 100 %	
Start up voltage (Vin)		55VAC					
Drop out voltage (Vin)		53VAC					
12V		1. Regulation - line and load				Condition Ta : 25 °C	
Iout \ Vin	85VAC	100VAC	200VAC	265VAC	Line regulation		
0%	11.698V	11.698V	11.698V	11.700V	2mV	0.017%	
50%	11.698V	11.698V	11.700V	11.698V	2mV	0.017%	
Full load	11.696V	11.696V	11.698V	11.698V	2mV	0.017%	
Load regulation	2mV	2mV	2mV	2mV			
	0.017%	0.017%	0.017%	0.017%			
		2. Temperature drift				Conditions Vin : 100 VAC Iout : Full load	
Ta	-10°C	+25°C	+55°C	Temperature stability			
Vout	11.685V	11.696V	11.702V	17mV	0.142%		
		3. Start up voltage and Drop out voltage				Conditions Ta : 25 °C Iout : 100 %	
Start up voltage (Vin)		53VAC					
Drop out voltage (Vin)		51VAC					
24V		1. Regulation - line and load				Condition Ta : 25 °C	
Iout \ Vin	85VAC	100VAC	200VAC	265VAC	Line regulation		
0%	23.892V	23.892V	23.892V	23.893V	1mV	0.004%	
50%	23.894V	23.894V	23.895V	23.889V	6mV	0.025%	
Full load	23.890V	23.889V	23.890V	23.891V	2mV	0.008%	
Load regulation	4mV	5mV	5mV	4mV			
	0.017%	0.021%	0.021%	0.017%			
		2. Temperature drift				Conditions Vin : 100 VAC Iout : Full load	
Ta	-10°C	+25°C	+55°C	Temperature stability			
Vout	23.890V	23.889V	23.875V	15mV	0.063%		
		3. Start up voltage and Drop out voltage				Conditions Ta : 25 °C Iout : 100 %	
Start up voltage (Vin)		52VAC					
Drop out voltage (Vin)		49VAC					

(2) リップルノイズ電圧対入力電圧 Ripple noise voltage vs. Input voltage

Conditions Iout : Full load
 Ta : -10 °C
 25 °C
 55 °C



5V

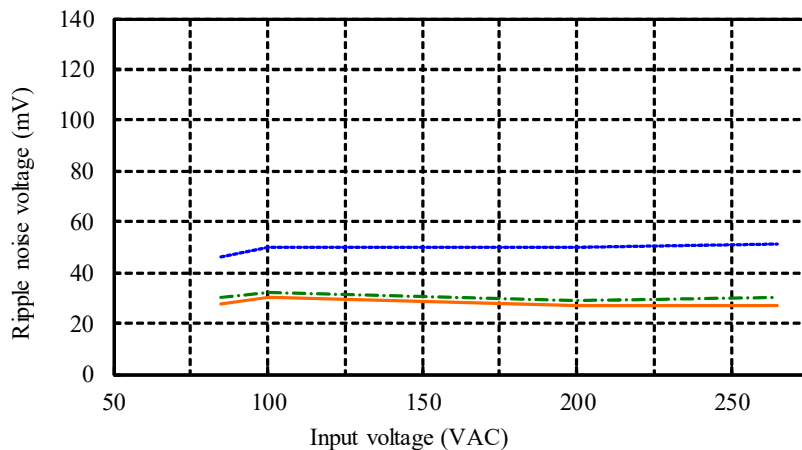

12V

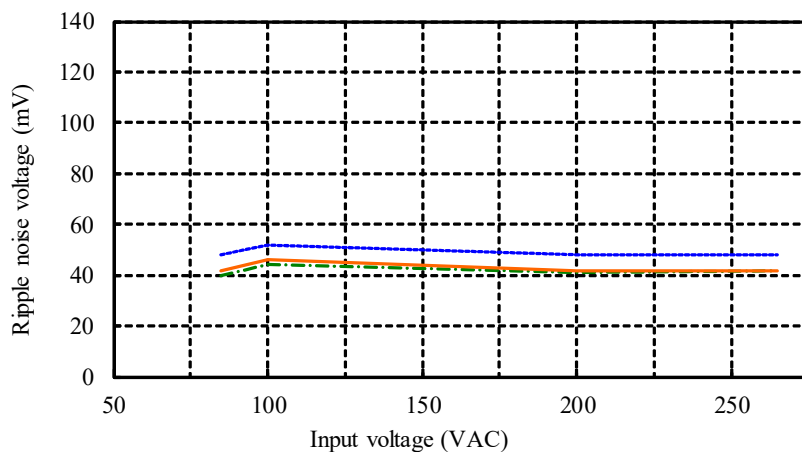

24

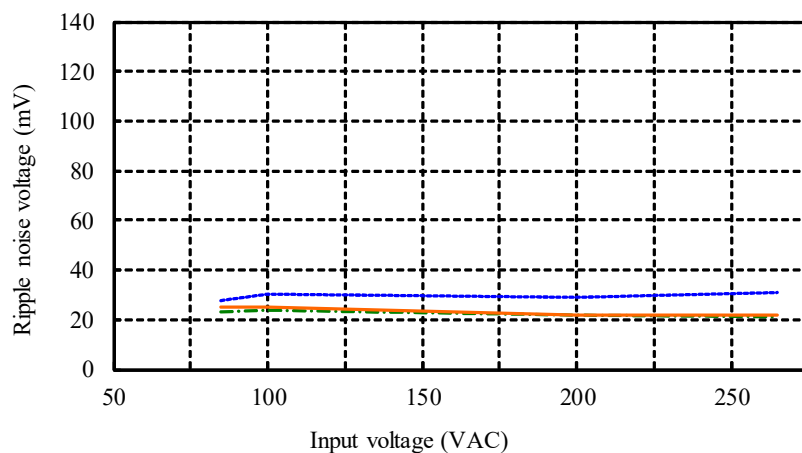

(3) 効率・力率対出力電流 Efficiency and Power factor vs. Output current

Conditions Vin : 85 VAC ---
100 VAC - - -
200 VAC ---
265 VAC - - -
Ta : 25 °C

5V

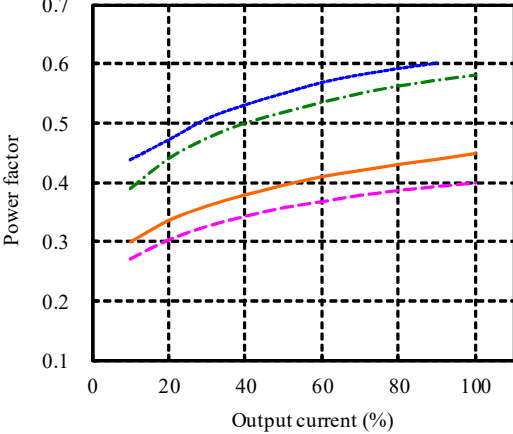
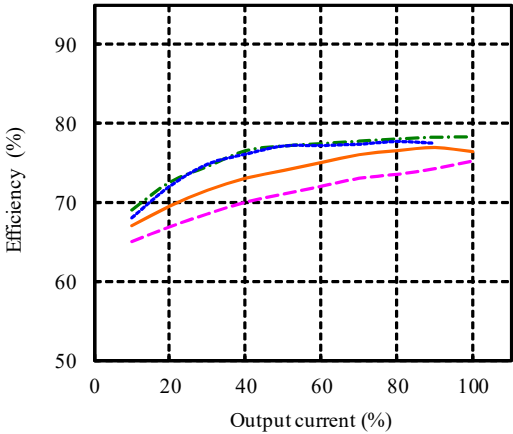

12V

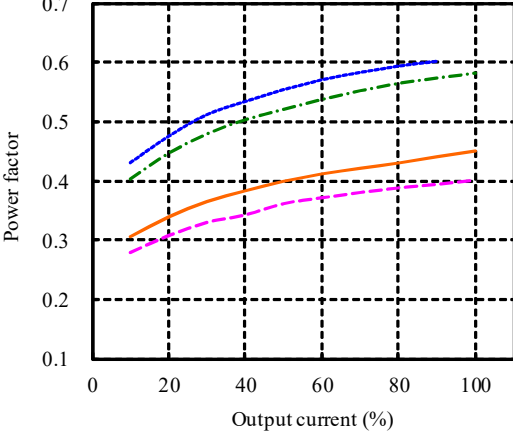
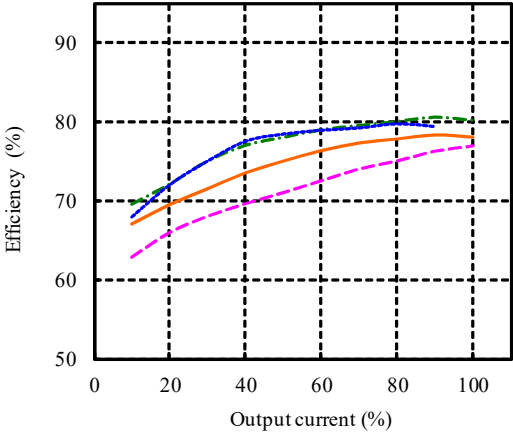

24V

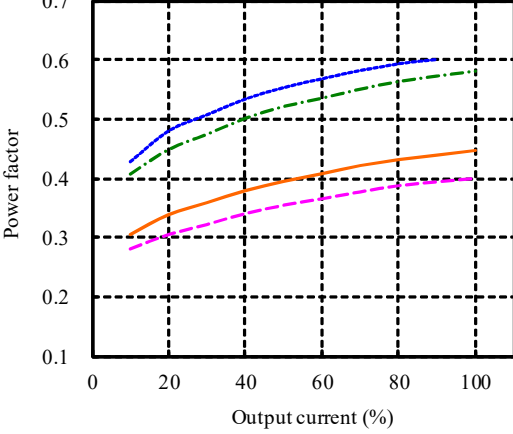
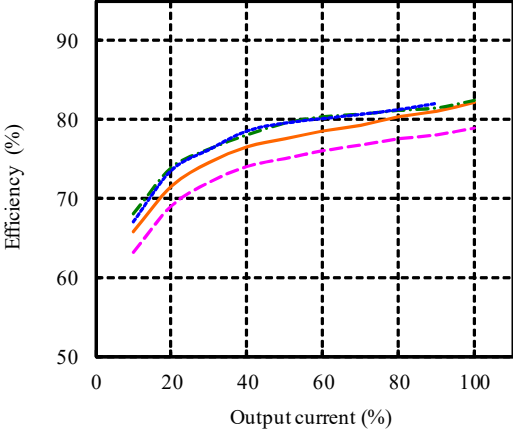

(4) 入力電力対出力電流 Input power vs. Output current

Conditions Vin : 85 VAC (blue dashed line)
 100 VAC (green dashed line)
 200 VAC (orange solid line)
 265 VAC (magenta dashed line)
 Ta : 25 °C

5V

Vin	Input power
	Iout : 0%
85VAC	0.02W
100VAC	0.02W
200VAC	0.02W
265VAC	0.06W

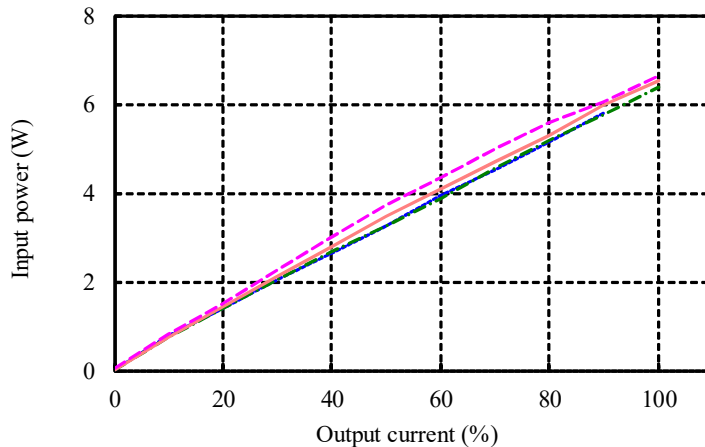

12V

Vin	Input power
	Iout : 0%
85VAC	0.04W
100VAC	0.04W
200VAC	0.04W
265VAC	0.07W

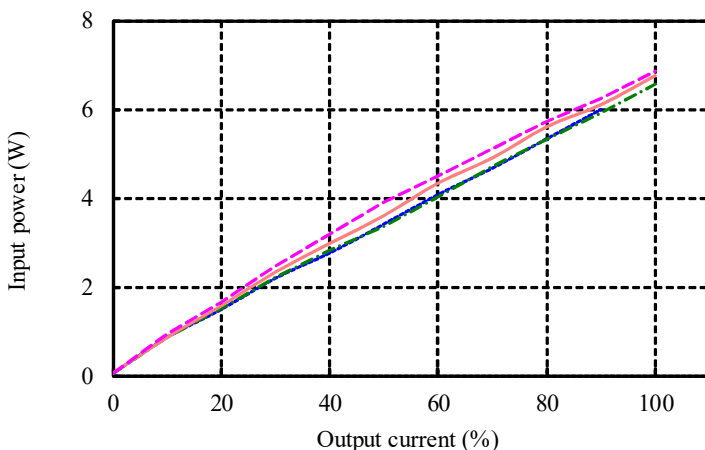

24V

Vin	Input power
	Iout : 0%
85VAC	0.06W
100VAC	0.06W
200VAC	0.07W
265VAC	0.11W

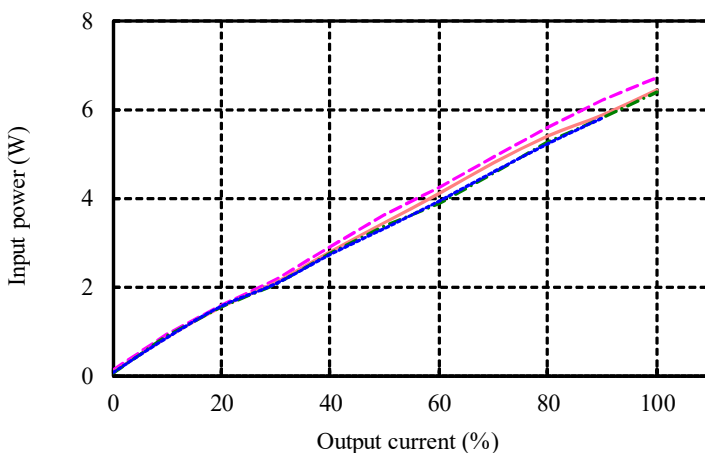

(5) 入力電流対出力電流 Input current vs. Output current

Conditions Vin : 85 VAC ---
 100 VAC - - -
 200 VAC ---
 265 VAC - - -
 Ta : 25 °C

5V

Vin	Input current
	Iout : 0%
85VAC	0.001A
100VAC	0.001A
200VAC	0.001A
265VAC	0.001A

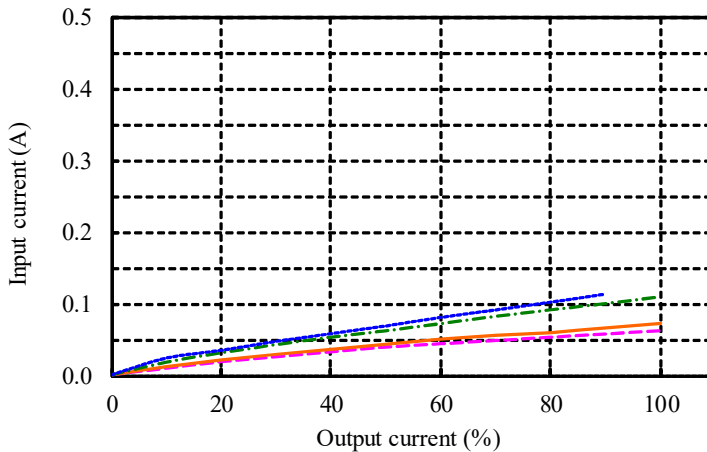

12V

Vin	Input current
	Iout : 0%
85VAC	0.002A
100VAC	0.002A
200VAC	0.001A
265VAC	0.002A

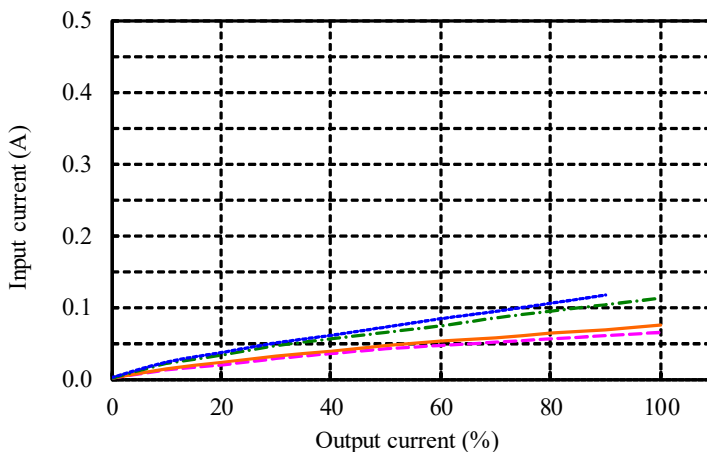

24V

Vin	Input current
	Iout : 0%
85VAC	0.003A
100VAC	0.002A
200VAC	0.002A
265VAC	0.002A

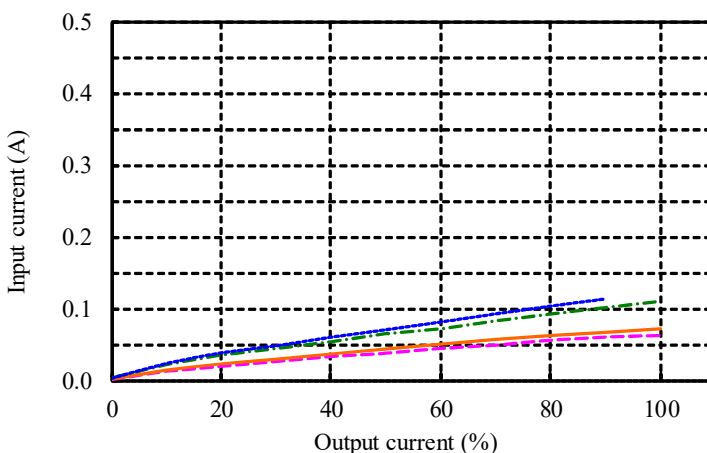

2-2. 通電ドリフト特性

Warm up voltage drift characteristics

Conditions Vin : 100 VAC
Iout : Full load
Ta : 25 °C

5V

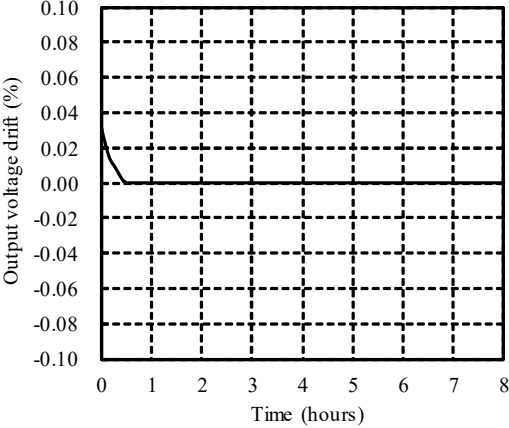

12V

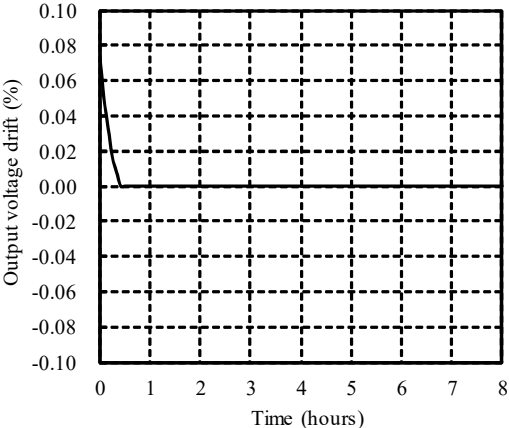

24V

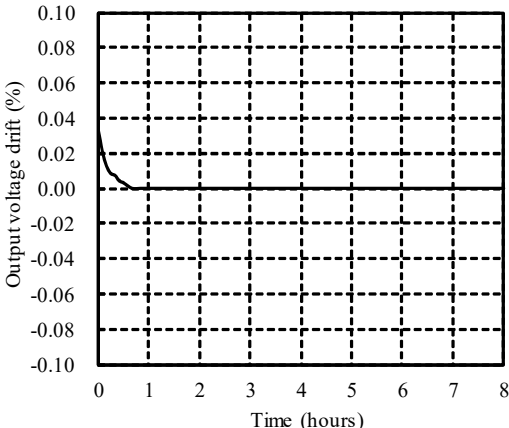

2-3. 出力保持時間特性

Hold up time characteristics

Conditions Vin : 100 VAC
200 VAC
Ta : 25 °C

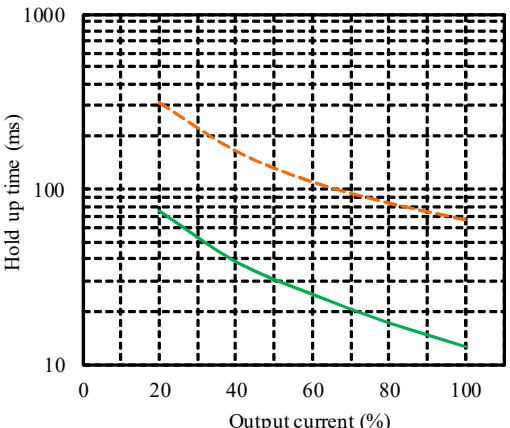
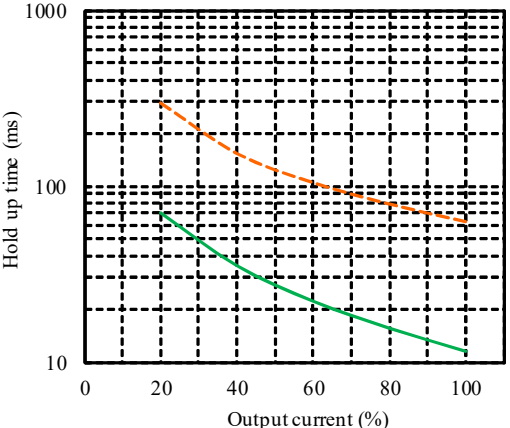
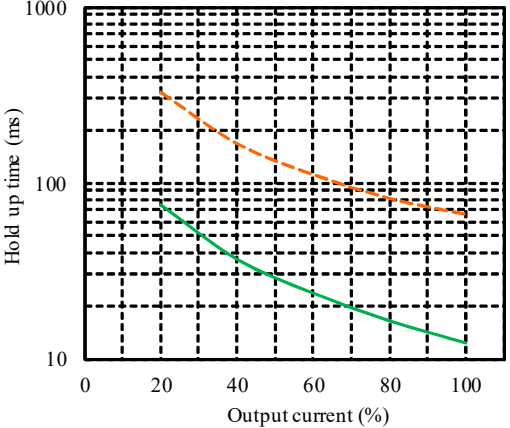

2-4. 出力立ち上がり特性 Output rise characteristics

Ta : 25 °C

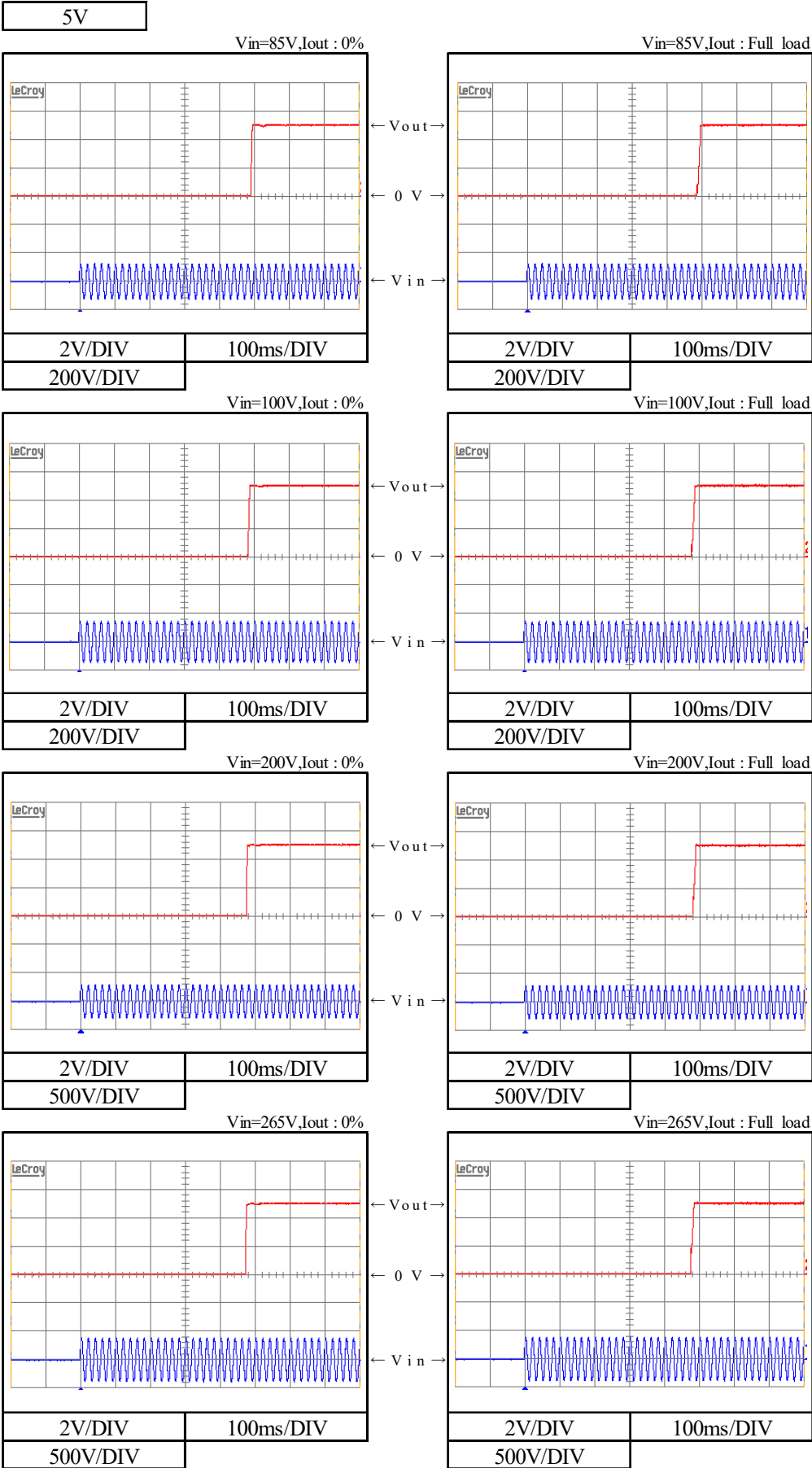

2-4. 出力立ち上がり特性 Output rise characteristics

Ta : 25 °C

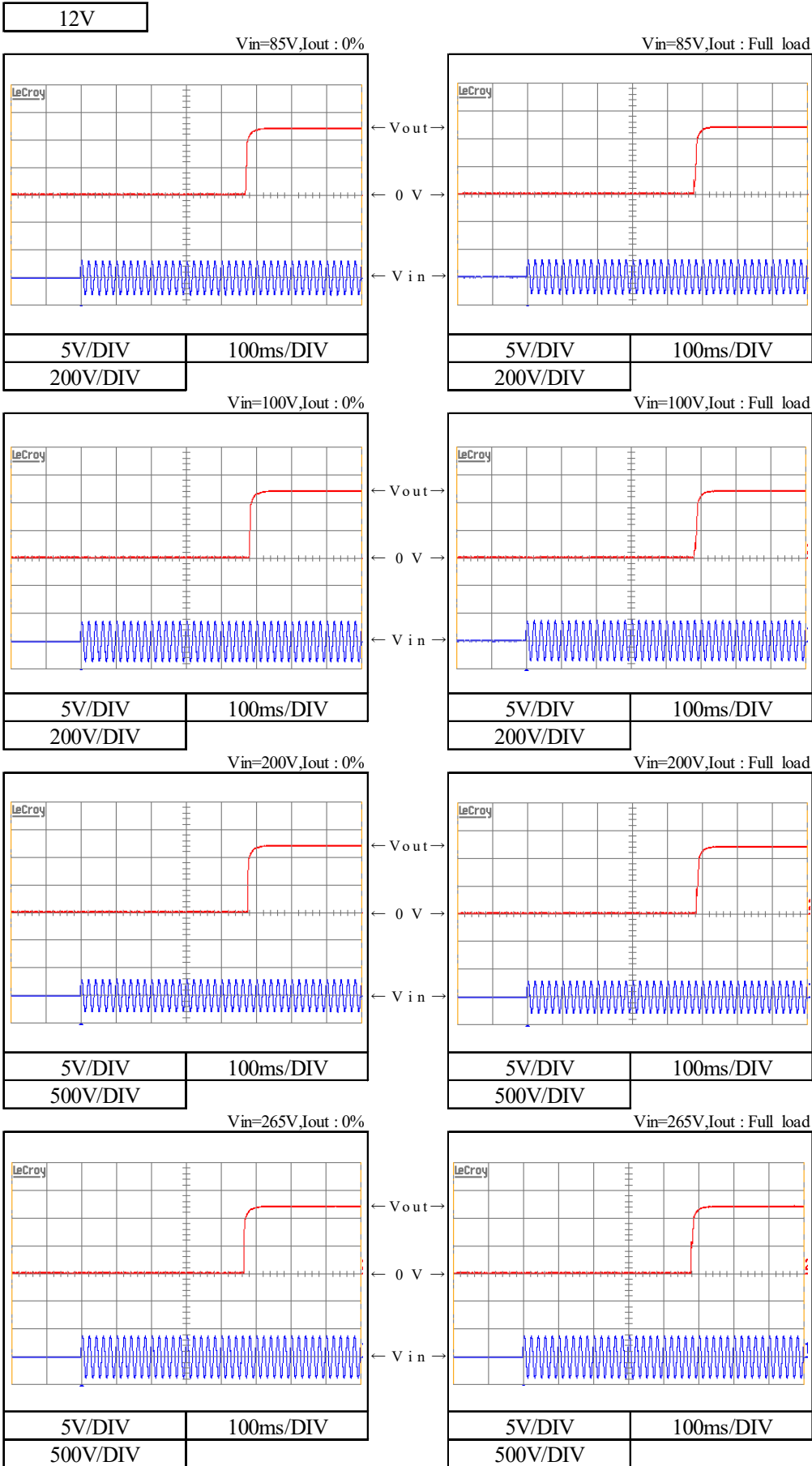

2-4. 出力立ち上がり特性 Output rise characteristics

Ta: 25 °C

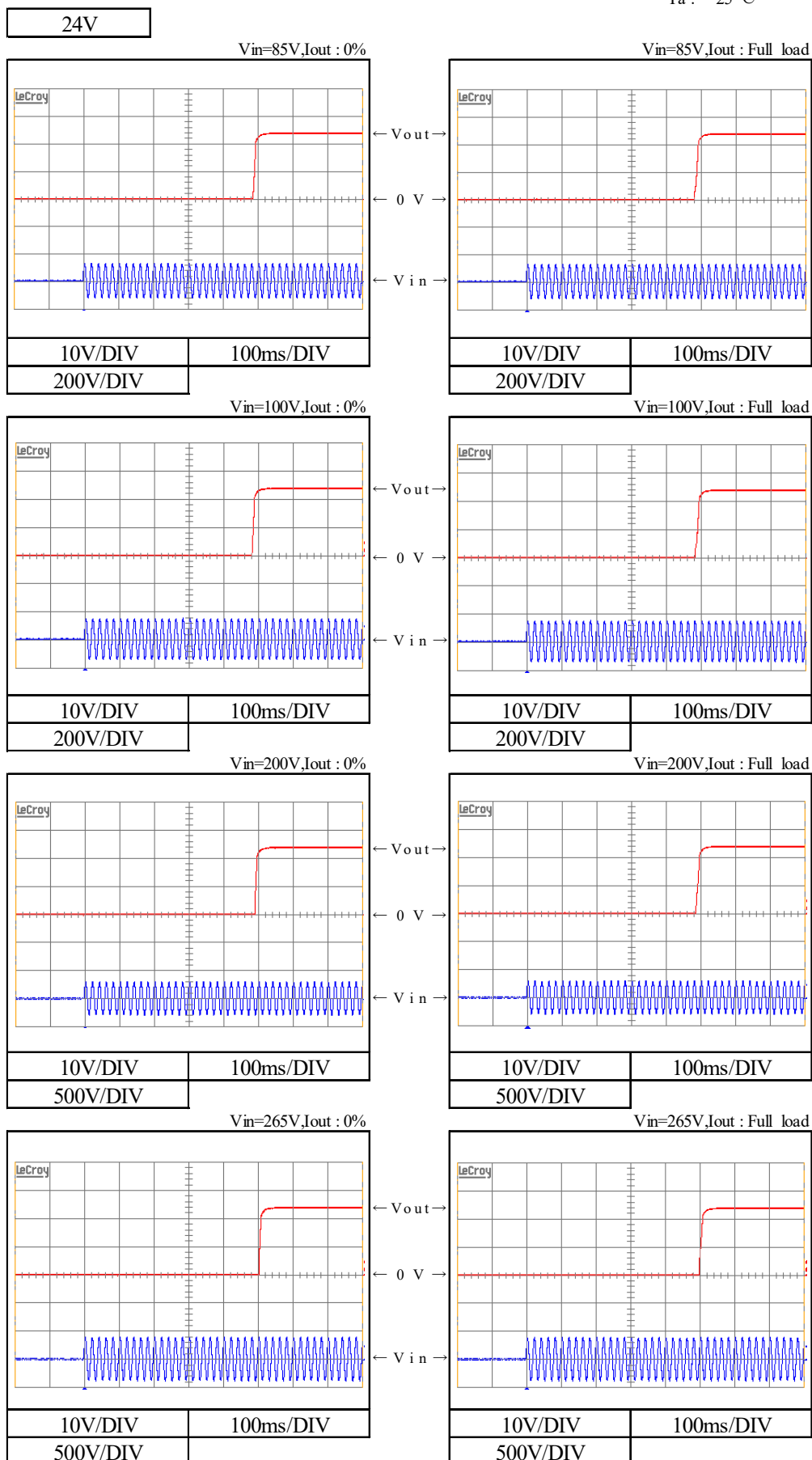

2-5. 出力立ち下がり特性 Output fall characteristics

Ta : 25 °C

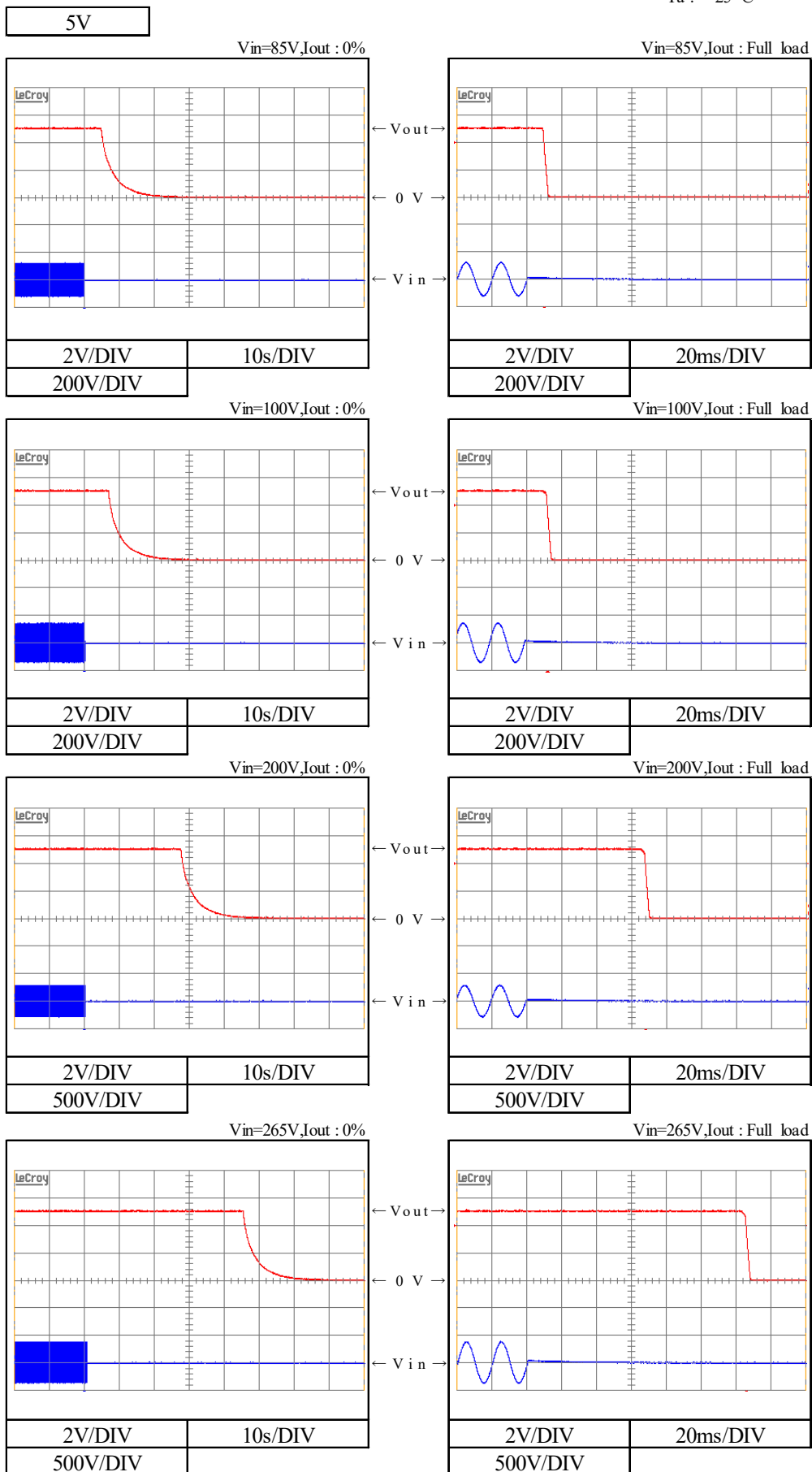

2-5. 出力立ち下がり特性 Output fall characteristics

Ta : 25 °C

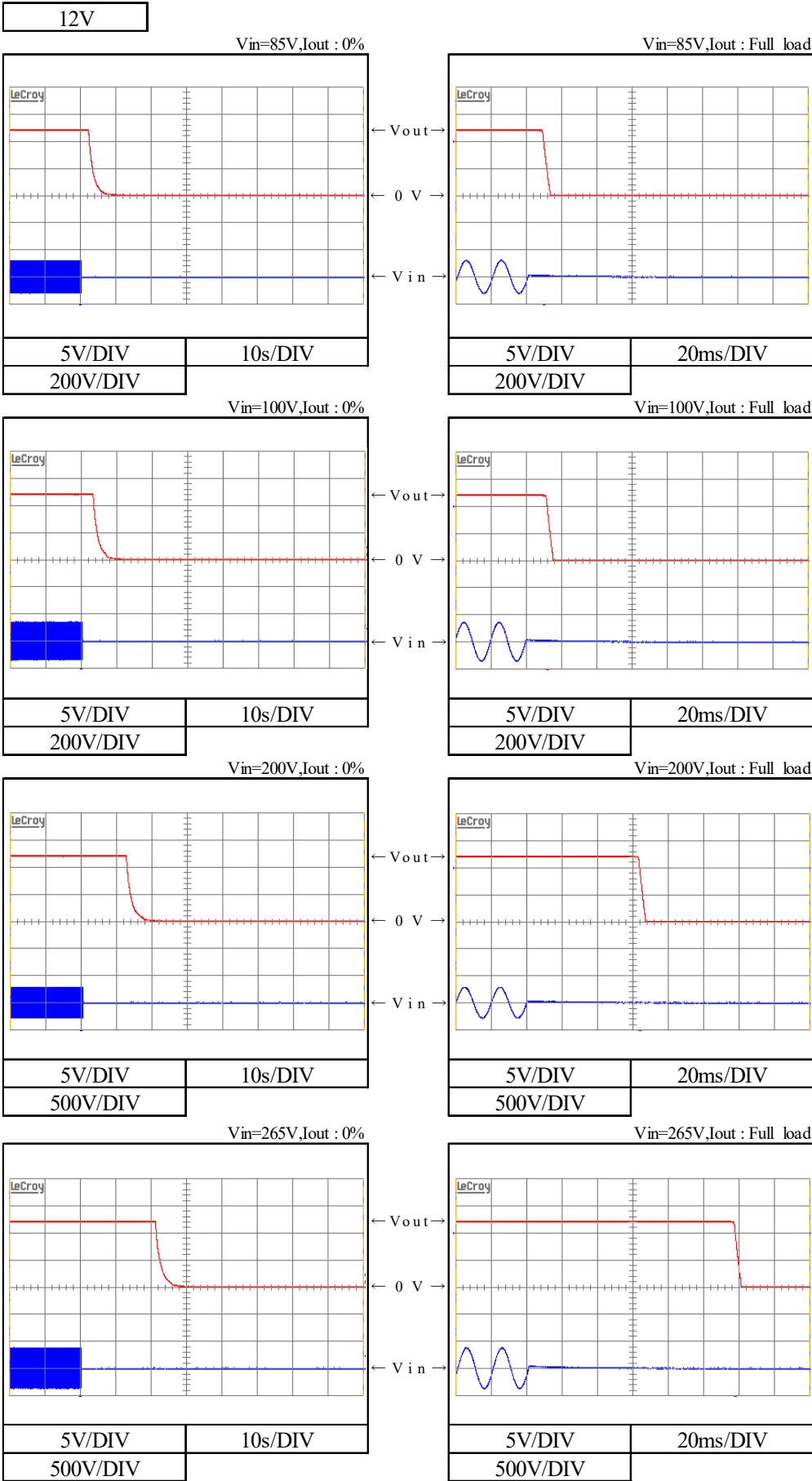

2-5. 出力立ち下がり特性 Output fall characteristics

Ta : 25 °C

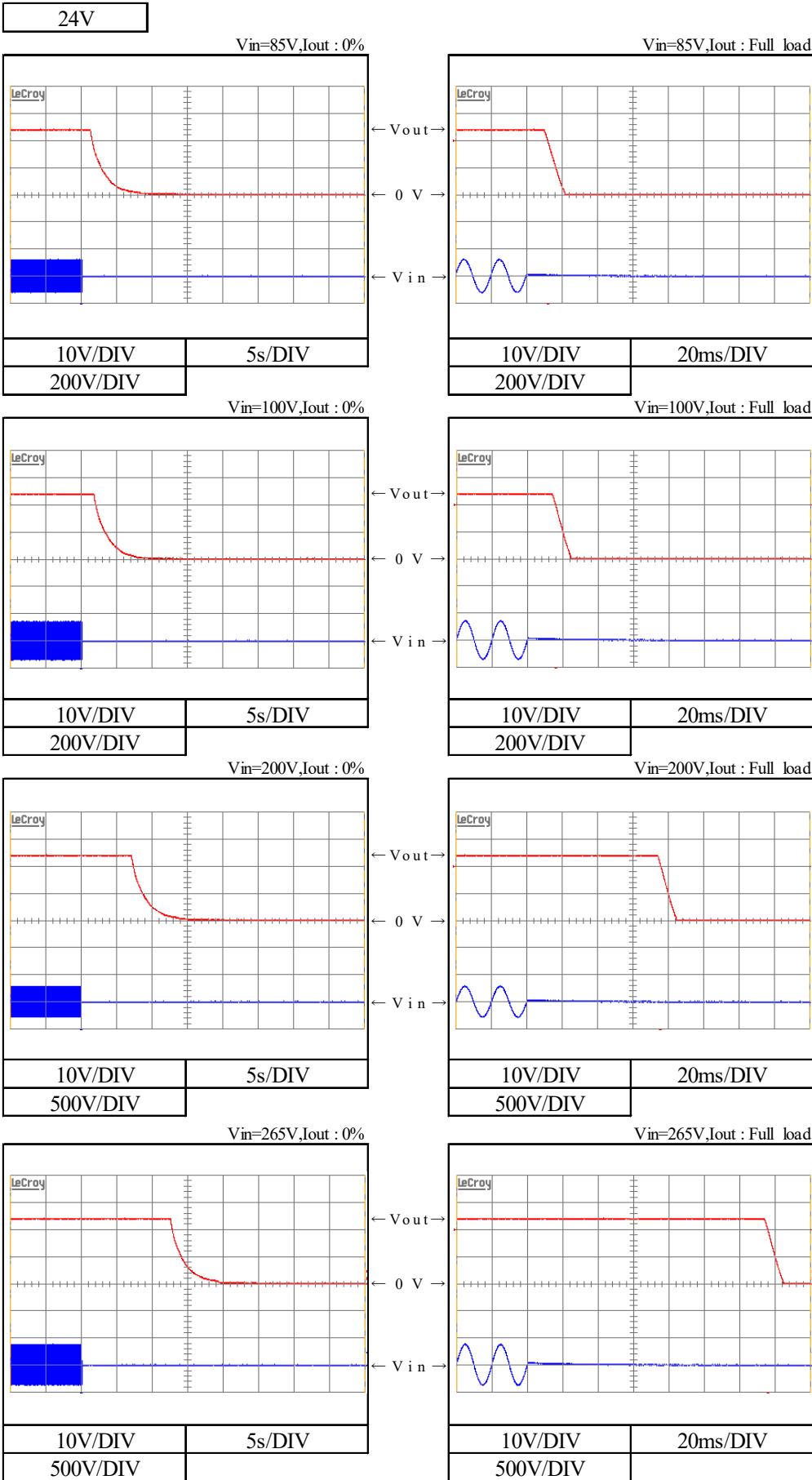

2-6. 過電流保護特性

Over current protection (OCP) characteristics

Conditions Vin : 100 VAC
 Ta : -10 °C (---)
 25 °C (---)
 55 °C (—)

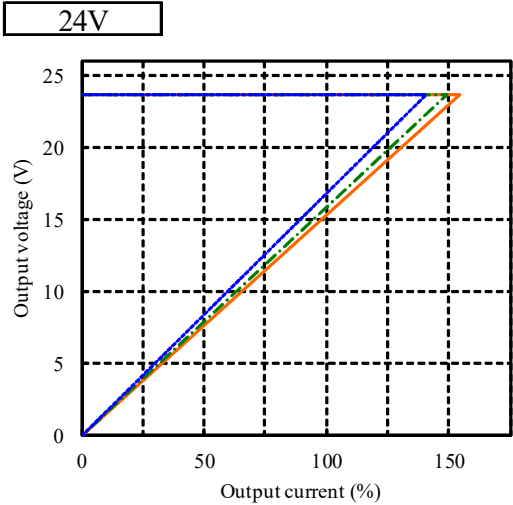
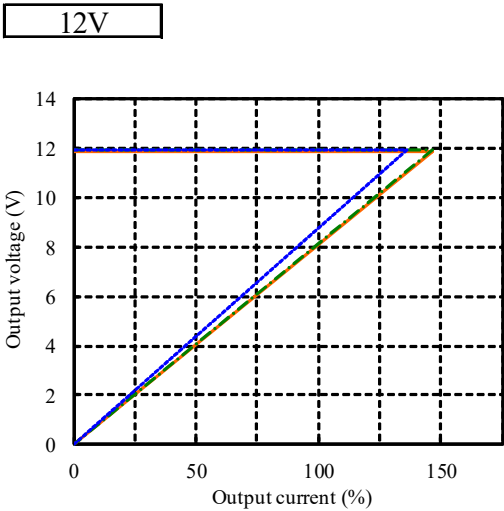
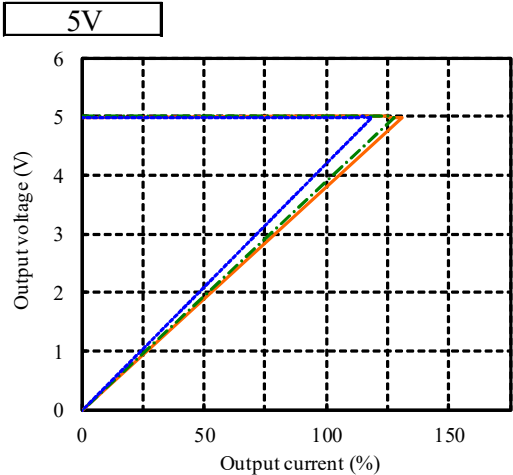

2-7. 過電圧保護特性

Over voltage protection (OVP) characteristics

Conditions Vin : 100 VAC
 Iout : 0 %
 Ta : 25 °C

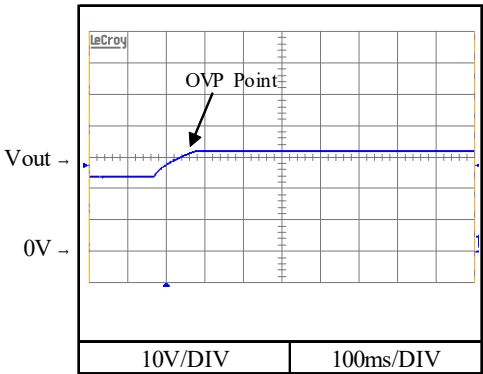
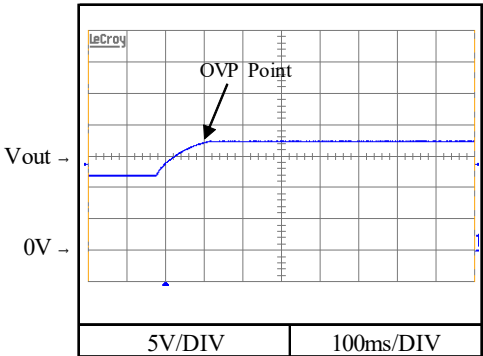
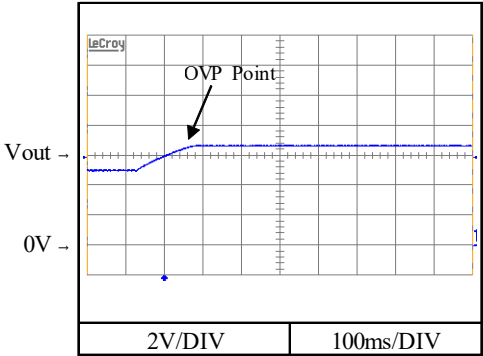

2-8. 過渡応答(負荷急変)特性 Dynamic load response characteristics

Conditions Vin : 100 VAC
 Iout : 50 % ↔ 100 %
 (tr = tf = 50us)
 Ta : 25 °C

5V

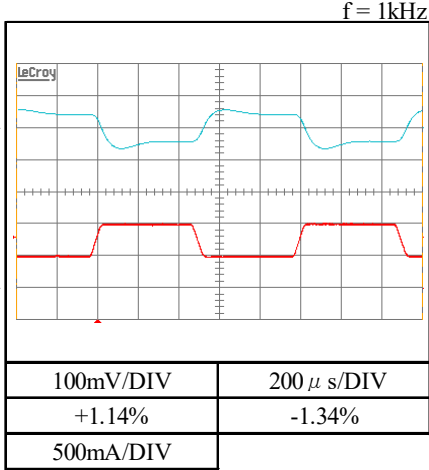
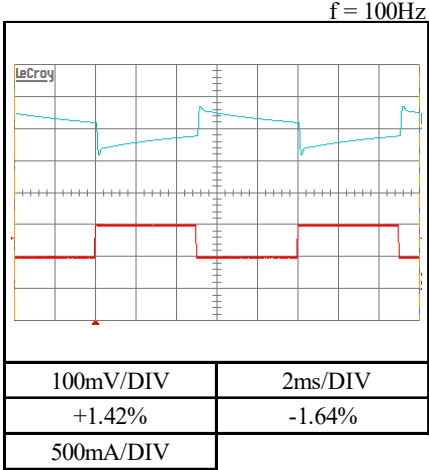

12V

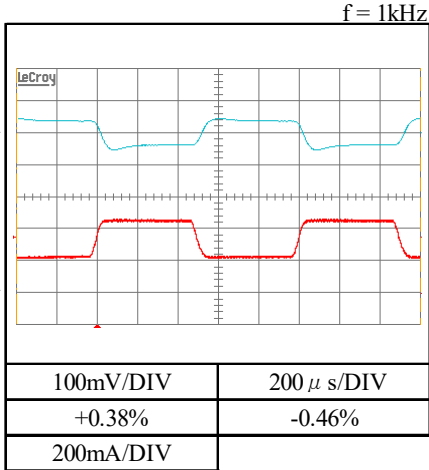
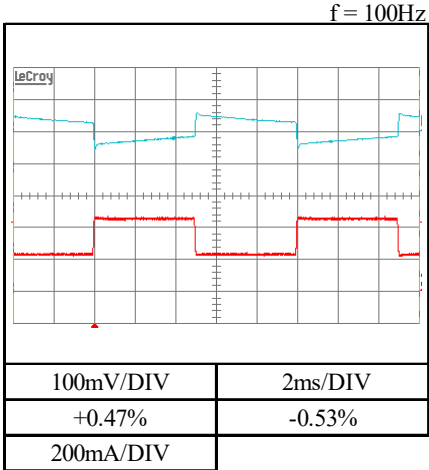

24V

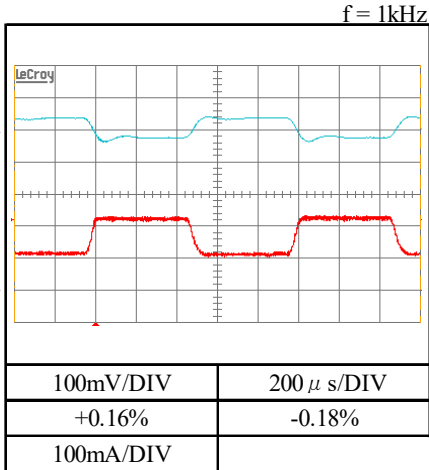
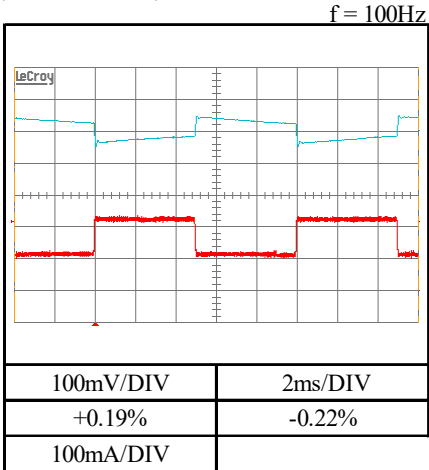

2-9. 入力電圧瞬停特性 Response to brown out characteristics

Conditions Ta : 25 °C
Iout : Full load

瞬停時間 Interruption time

- A : 出力電圧が低下なし Without any output voltage drop.
- B : 出力電圧が20-40%低下 Output voltage to drop down to 20-40%.
- C : 出力電圧が0Vまで低下 Output voltage to drop down to 0V.

5V

Vin : 100VAC

A = 9ms,

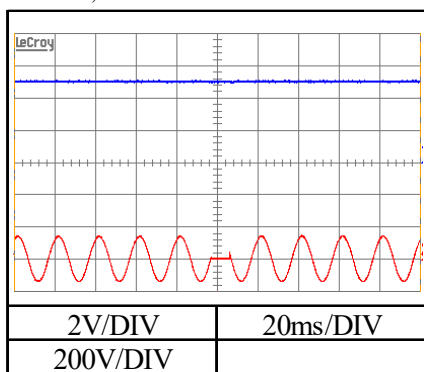

Vin : 200VAC

A = 64ms,

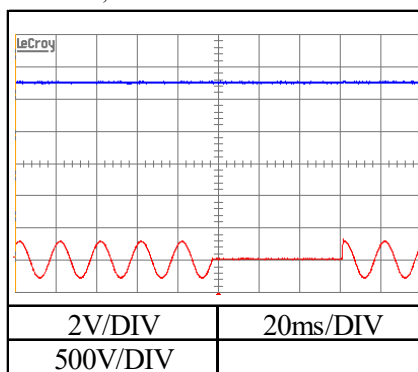

Vin : 100VAC

B = 14ms,

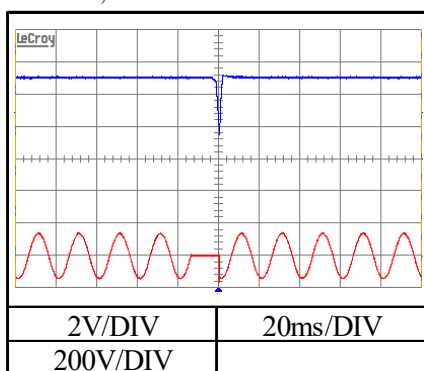

Vin : 200VAC

B = 69ms,

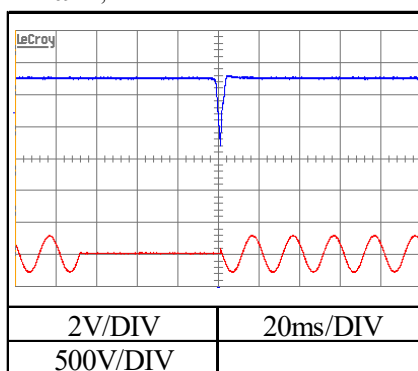

Vin : 100VAC

C = 15ms

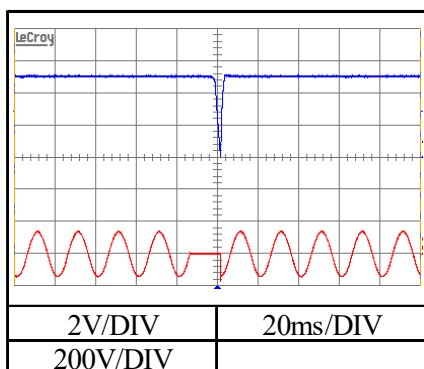

Vin : 200VAC

C = 70ms

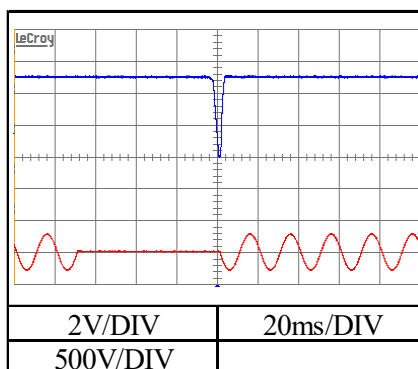

2-9. 入力電圧瞬停特性 Response to brown out characteristics

Conditions Ta : 25 °C
Iout : Full load

瞬停時間 Interruption time

- A : 出力電圧が低下なし Without any output voltage drop.
- B : 出力電圧が20-40%低下 Output voltage to drop down to 20-40%.
- C : 出力電圧が0Vまで低下 Output voltage to drop down to 0V.

12V

Vin : 100VAC

A = 10ms,

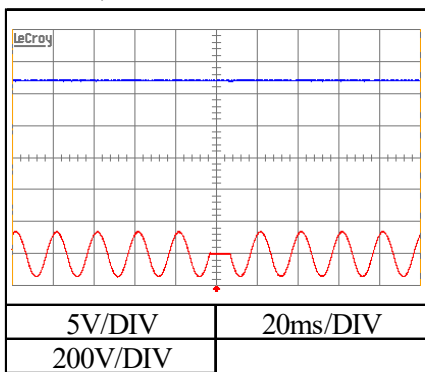

Vin : 200VAC

A = 62ms,

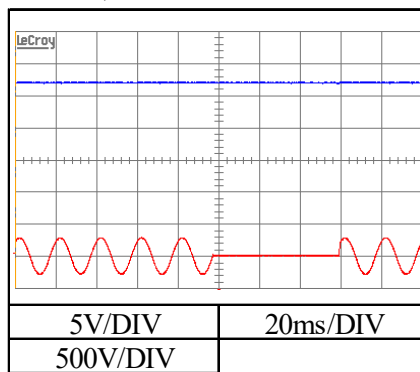

Vin : 100VAC

B = 14ms,

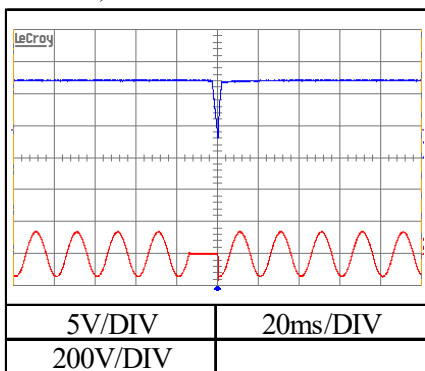

Vin : 200VAC

B = 66ms,

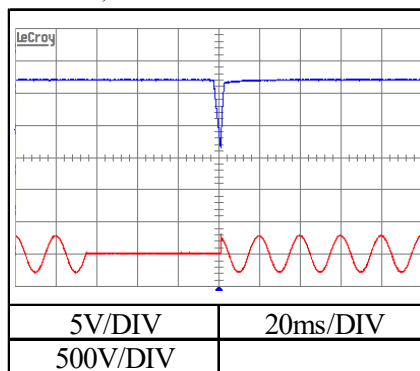

Vin : 100VAC

C = 15ms,

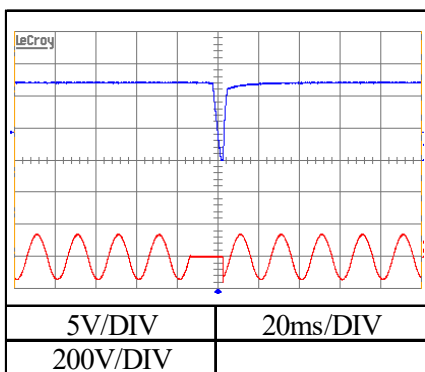

Vin : 200VAC

C = 67ms,

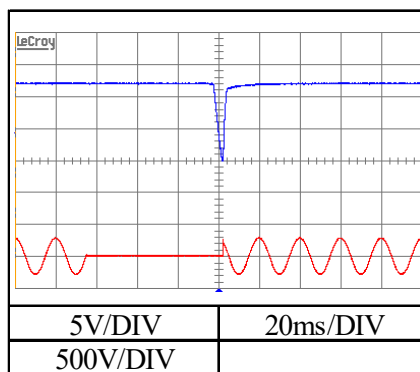

2-9. 入力電圧瞬停特性 Response to brown out characteristics

Conditions Ta : 25 °C
Iout : Full load

瞬停時間 Interruption time

- A : 出力電圧が低下なし Without any output voltage drop.
- B : 出力電圧が20-40%低下 Output voltage to drop down to 20-40%.
- C : 出力電圧が0Vまで低下 Output voltage to drop down to 0V.

24V

Vin : 100VAC

A = 12ms,

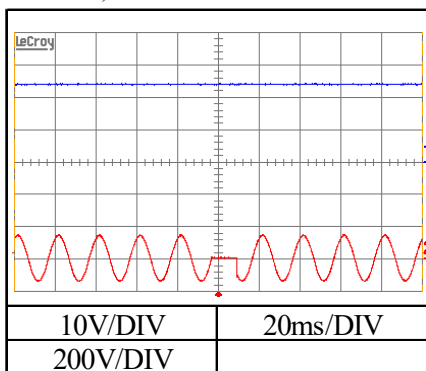

Vin : 200VAC

A = 66ms,

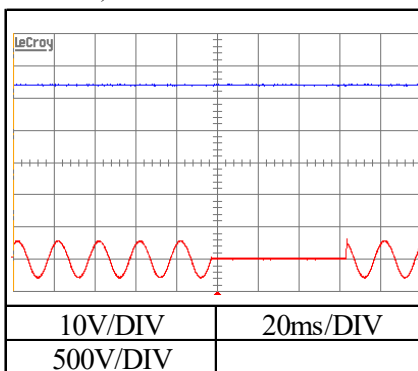

Vin : 100VAC

B = 22ms,

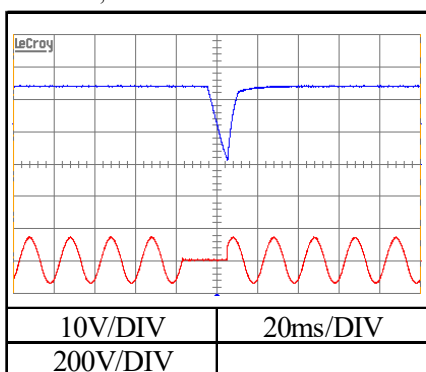

Vin : 200VAC

B = 76ms,

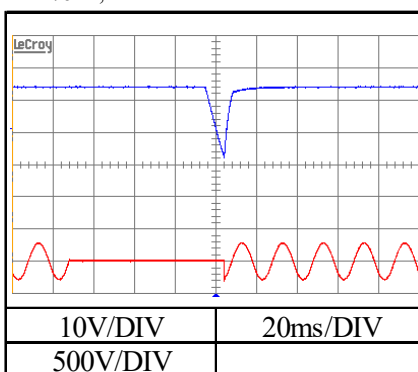

Vin : 100VAC

C = 23ms

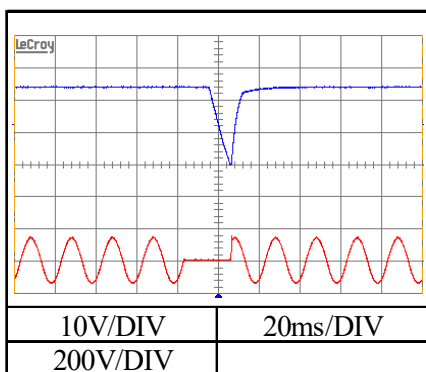

Vin : 200VAC

C = 77ms

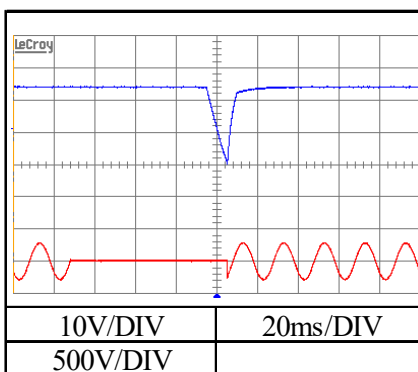

2-10. 入力サージ電流(突入電流)波形 Inrush current waveform

24V

Conditions Vin : 100 VAC
Iout : Full load
Ta : 25°C

Switch on phase angle of input AC voltage
 $\phi = 0^\circ$

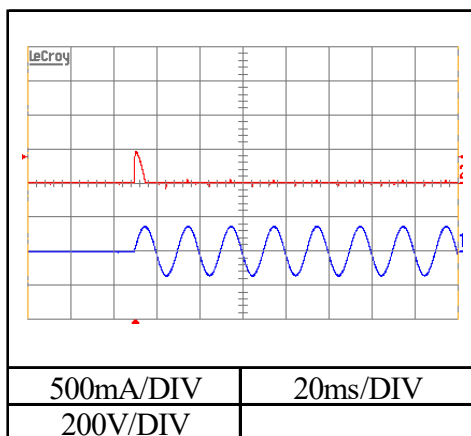

Switch on phase angle of input AC voltage
 $\phi = 90^\circ$

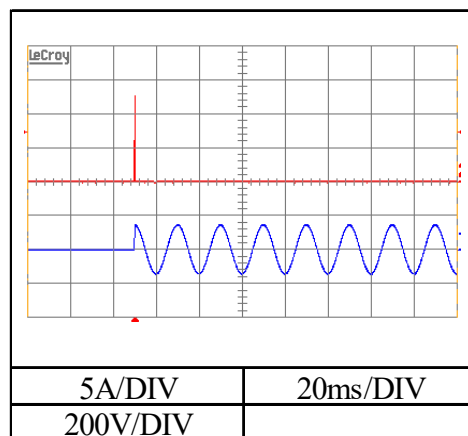

Conditions Vin : 200 VAC
Iout : Full load
Ta : 25°C

Switch on phase angle of input AC voltage
 $\phi = 0^\circ$

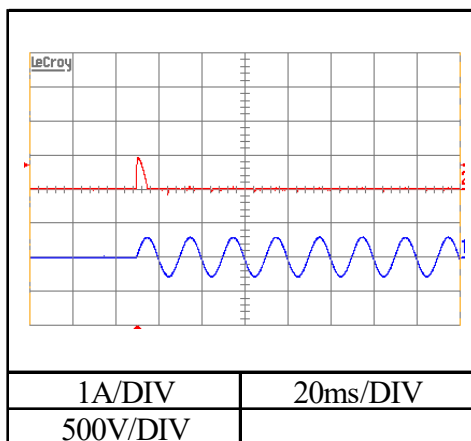

Switch on phase angle of input AC voltage
 $\phi = 90^\circ$

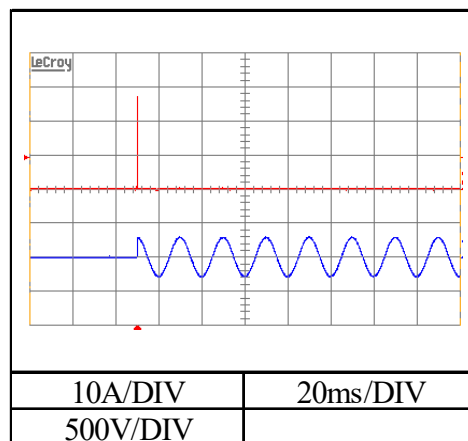

2-11. 入力電流波形 Input current waveform

Conditions Iout : Full load
Ta : 25°C

5V

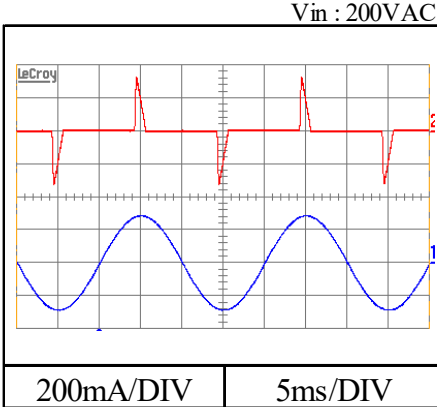
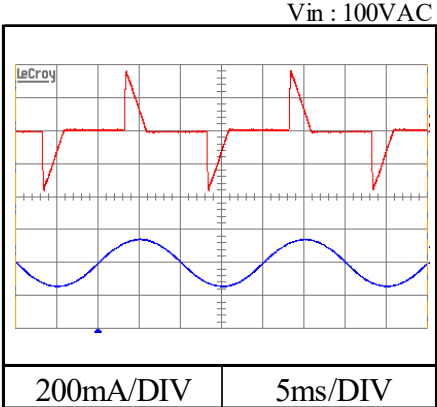

12V

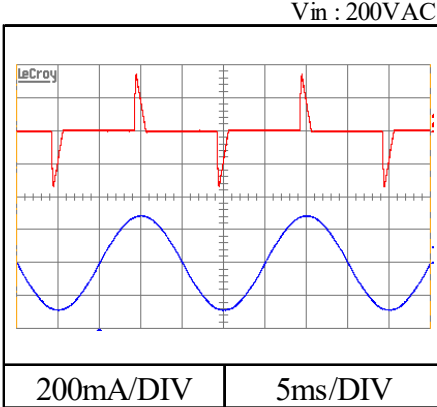
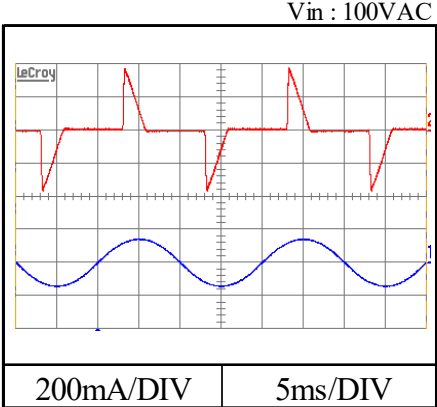

24V

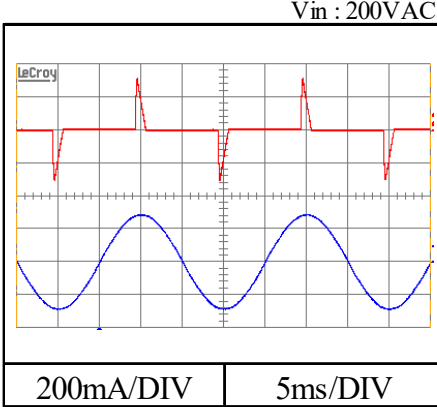
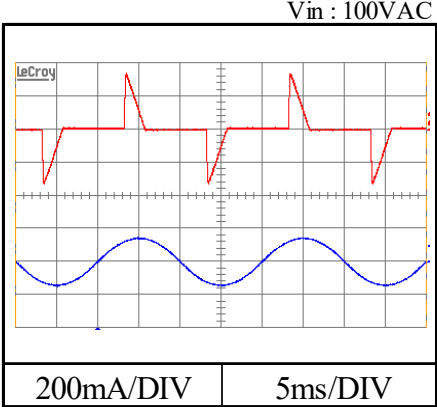

2-12. 出力リップル、ノイズ波形 Output ripple and noise waveform

Conditions Vin : 100 VAC
Iout : Full load
Ta : 25°C

5V

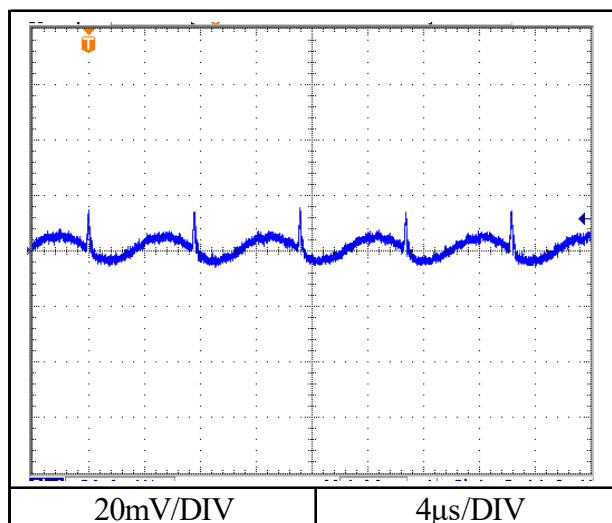

12V

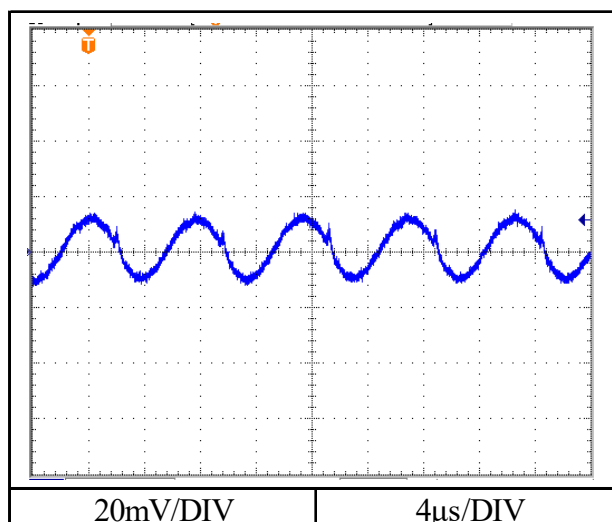

24V

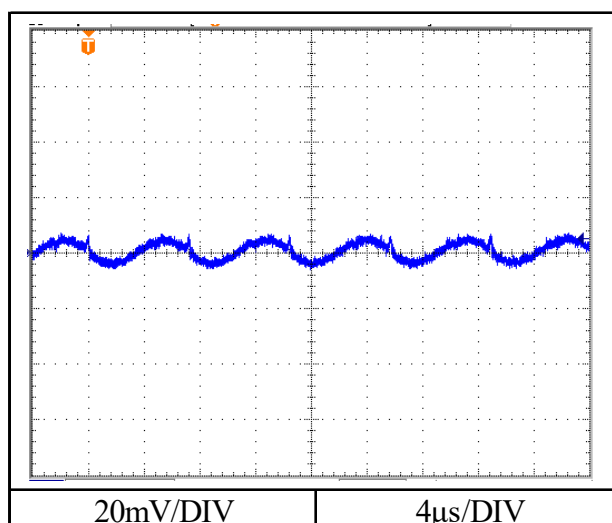

2-13. EMI特性 Electro-Magnetic Interference characteristics

Conditions Vin : 230 VAC
Iout : Full load
Ta : 25 °C

雑音端子電圧
Conducted Emission

5V

Point A (857kHz)		
Ref. Data	Limit (dB)	Measure (dB)
QP	73.0	53.2
AV	60.0	37.7

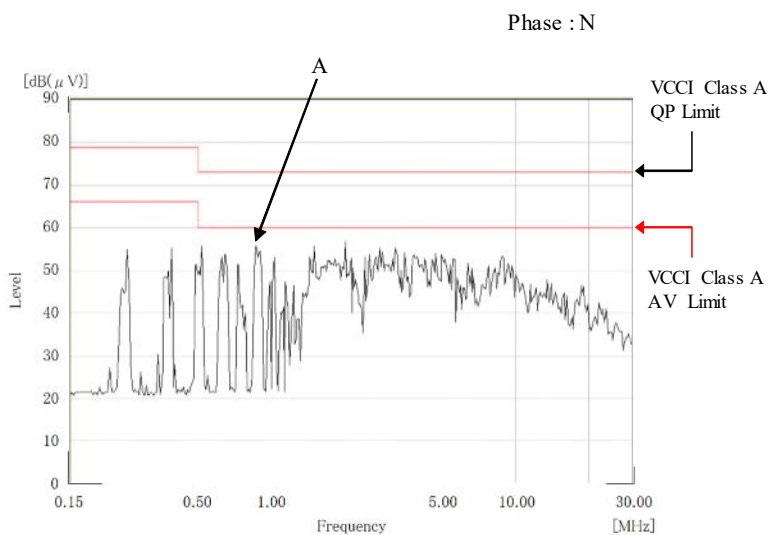

Point B (646kHz)		
Ref. Data	Limit (dB)	Measure (dB)
QP	73.0	51.6
AV	60.0	38.0

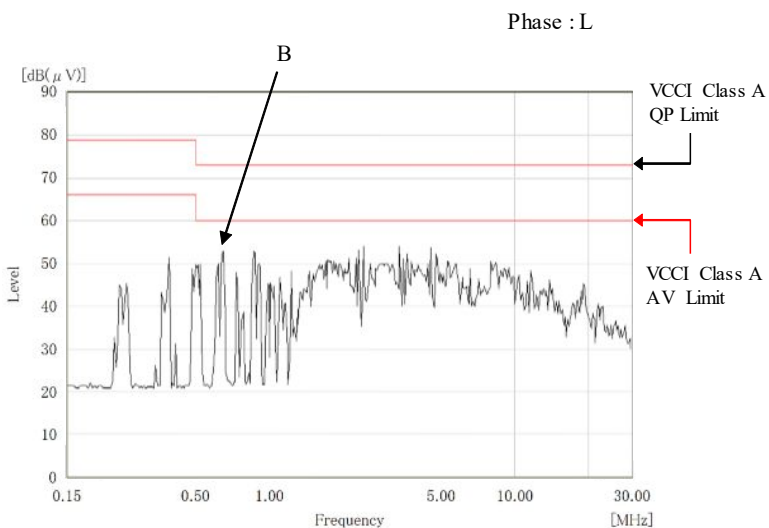

EN55011-A,EN55032-A,FCC-Aの限界値はVCCI class Aの限界値と同じ
Limit of EN55011-A,EN55032-A,FCC-A are same as its VCCI class A.

Conditions Vin : 230 VAC
Iout : Full load
Ta : 25°C

雑音端子電圧
Conducted Emission

12V

Point A (662kHz)		
Ref. Data	Limit (dB)	Measure (dB)
QP	73.0	54.5
AV	60.0	40.6

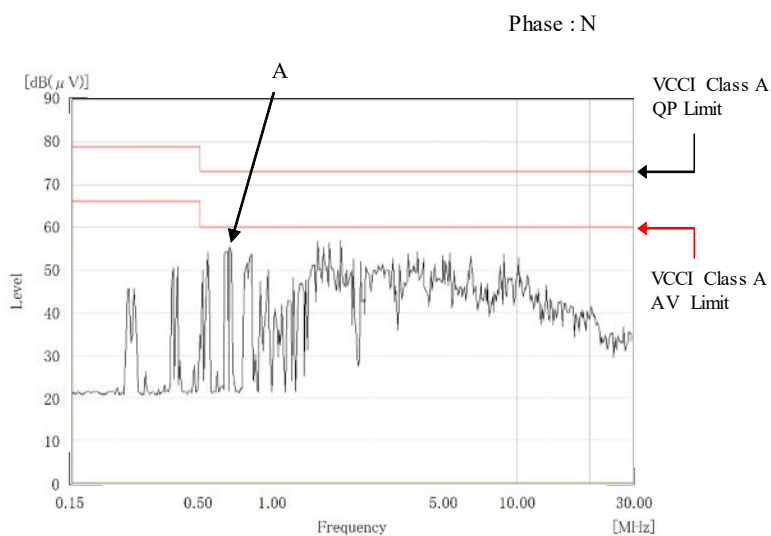

Point B (654kHz)		
Ref. Data	Limit (dB)	Measure (dB)
QP	73.0	51.9
AV	60.0	37.0

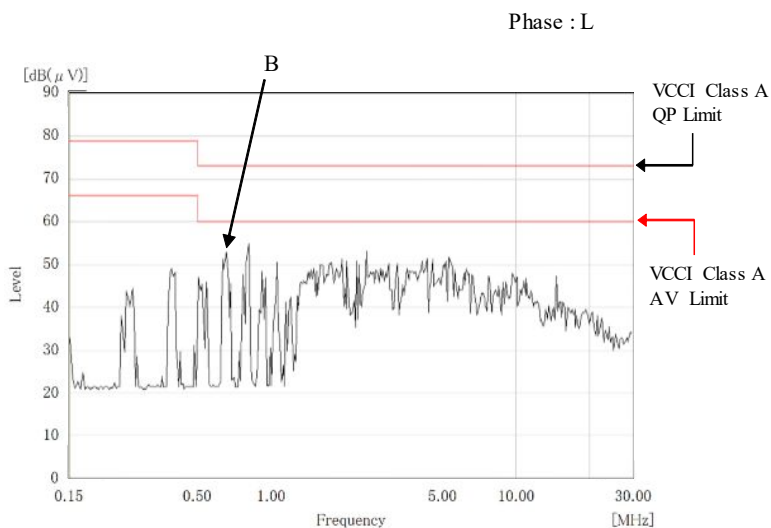

EN55011-A,EN55032-A,FCC-Aの限界値はVCCI class Aの限界値と同じ
Limit of EN55011-A,EN55032-A,FCC-A are same as its VCCI class A.

Conditions Vin : 230 VAC
 Iout : Full load
 Ta : 25°C

雑音端子電圧
 Conducted Emission

24V

Point A (650kHz)		
Ref. Data	Limit (dB)	Measure (dB)
QP	73.0	52.0
AV	60.0	37.8

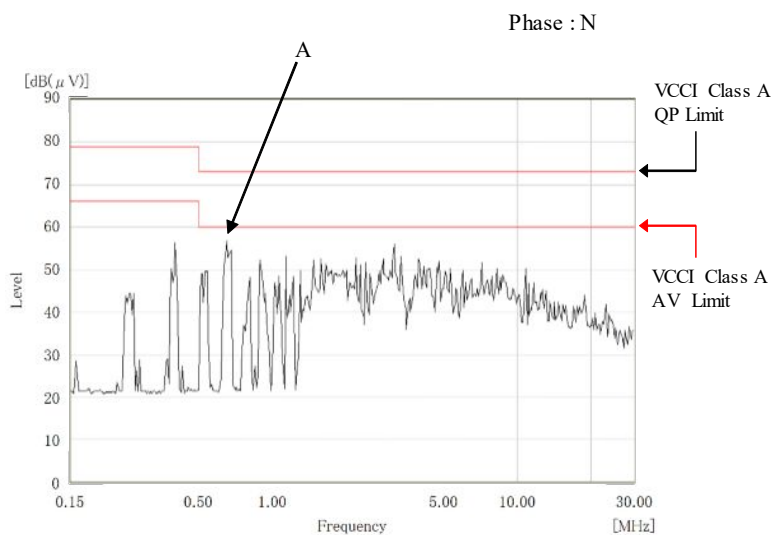

Point B (670kHz)		
Ref. Data	Limit (dB)	Measure (dB)
QP	73.0	49.0
AV	60.0	34.9

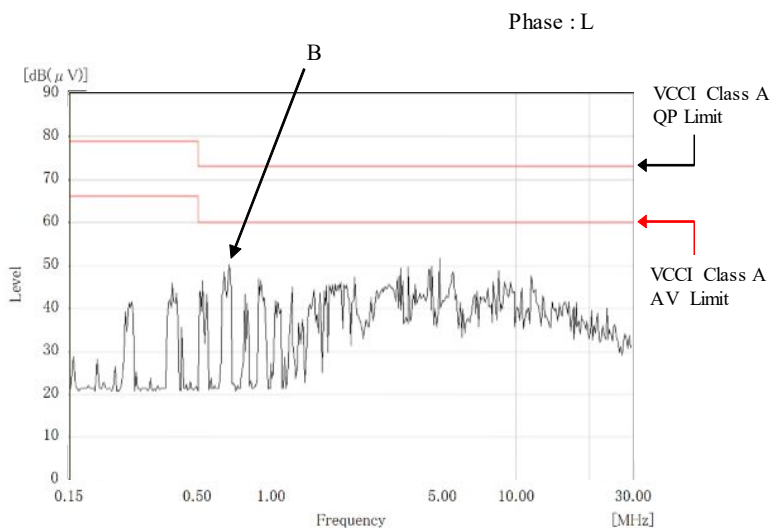

EN55011-A,EN55032-A,FCC-Aの限界値はVCCI class Aの限界値と同じ
 Limit of EN55011-A,EN55032-A,FCC-A are same as its VCCI class A.

Conditions Vin : 230 VAC
Iout : Full load
Ta : 25 °C

雑音端子電圧
Conducted Emission

5V

Point A (642kHz)		
Ref. Data	Limit (dB)	Measure (dB)
QP	56.0	45.9
AV	46.0	25.4

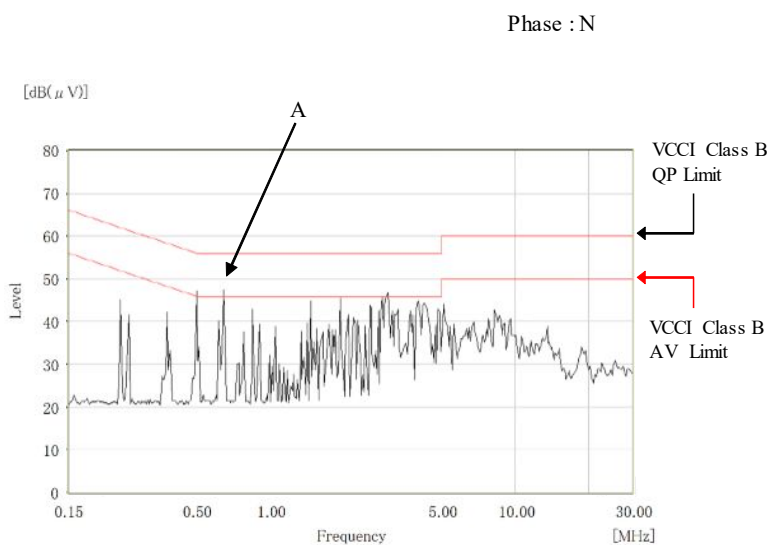

Point B (877kHz)		
Ref. Data	Limit (dB)	Measure (dB)
QP	56.0	44.4
AV	46.0	22.3

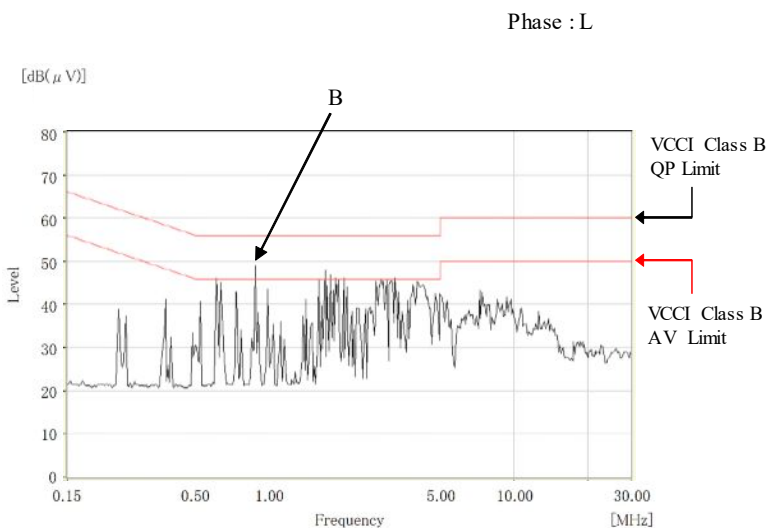

EN55011-B,EN55032-B,FCC-Bの限界値はVCCI class Bの限界値と同じ
Limit of EN55011-B,EN55032-B,FCC-B are same as its VCCI class B.

Conditions Vin : 230 VAC
Iout : Full load
Ta : 25 °C

雑音端子電圧
Conducted Emission

12V

Point A (662Hz)		
Ref. Data	Limit (dB)	Measure (dB)
QP	56.0	48.6
AV	46.0	29.1

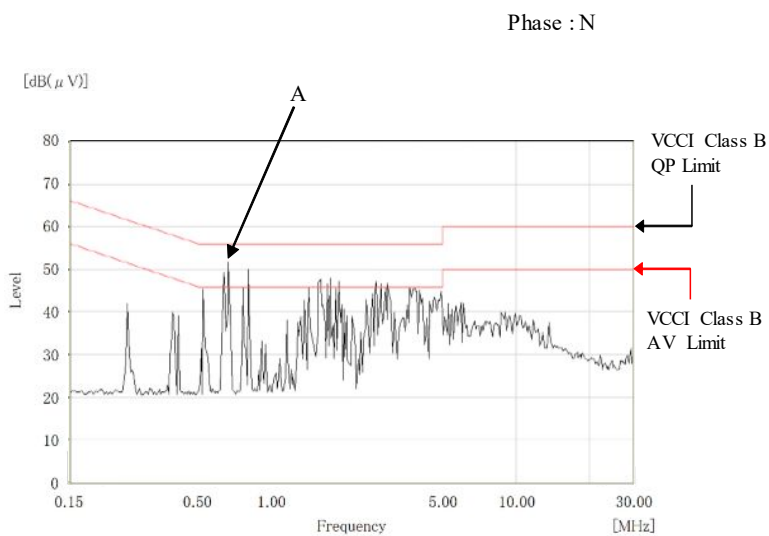

Point B (658kHz)		
Ref. Data	Limit (dB)	Measure (dB)
QP	56.0	47.9
AV	46.0	28.8

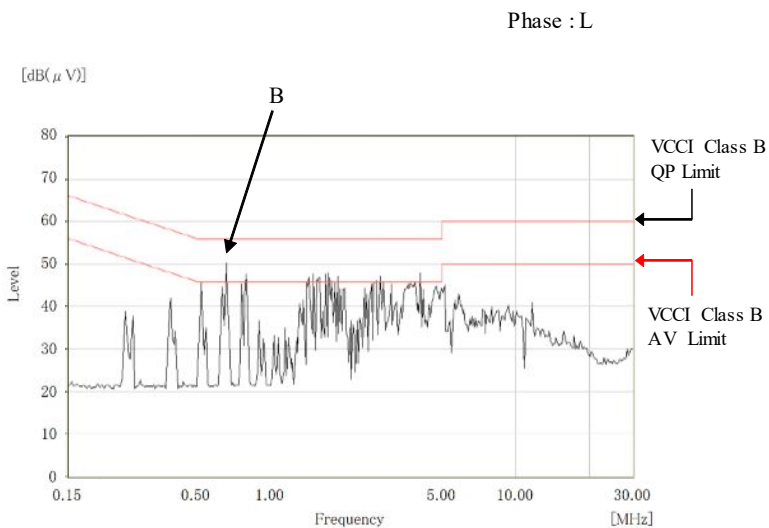

EN55011-B,EN55032-B,FCC-Bの限界値はVCCI class Bの限界値と同じ
Limit of EN55011-B,EN55032-B,FCC-B are same as its VCCI class B.

Conditions Vin : 230 VAC
Iout : Full load
Ta : 25 °C

雑音端子電圧
Conducted Emission

24V

Point A (656kHz)		
Ref. Data	Limit (dB)	Measure (dB)
QP	56.0	47.8
AV	46.0	29.1

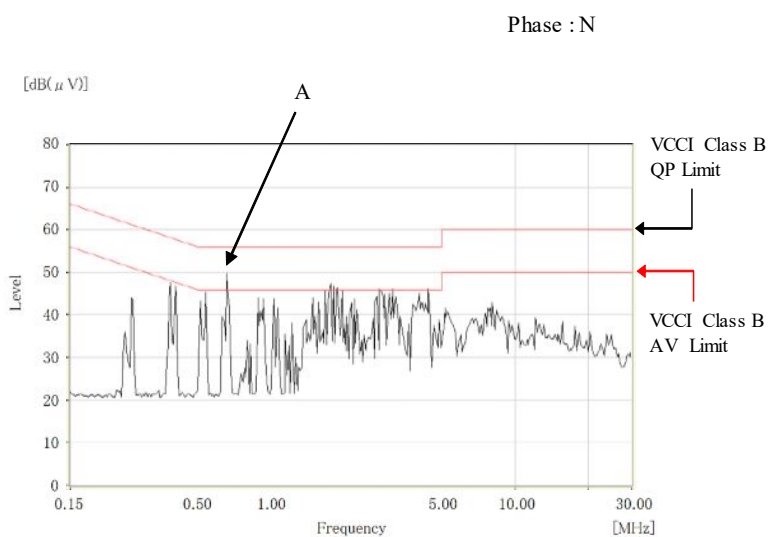

Point B (650kHz)		
Ref. Data	Limit (dB)	Measure (dB)
QP	56.0	47.0
AV	46.0	28.7

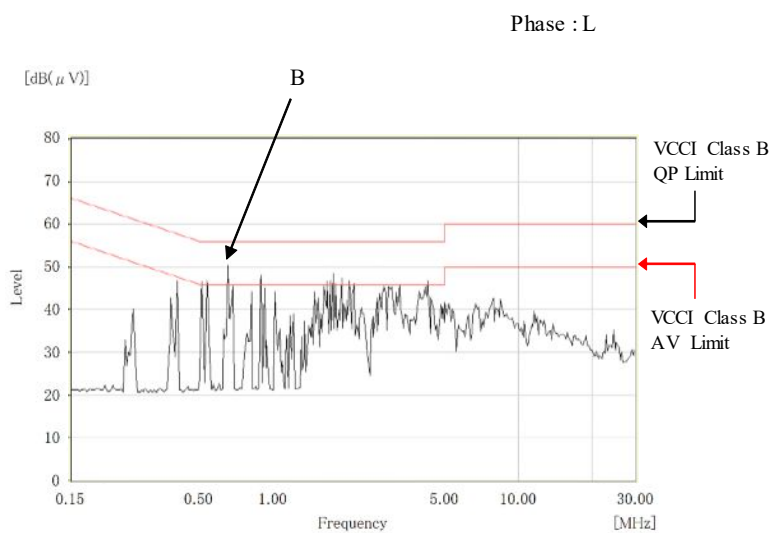

EN55011-B,EN55032-B,FCC-Bの限界値はVCCI class Bの限界値と同じ
Limit of EN55011-B,EN55032-B,FCC-B are same as its VCCI class B.

Conditions Vin : 110 VAC
Iout : Full load
Ta : 25°C

雑音電界強度
Radiated Emission

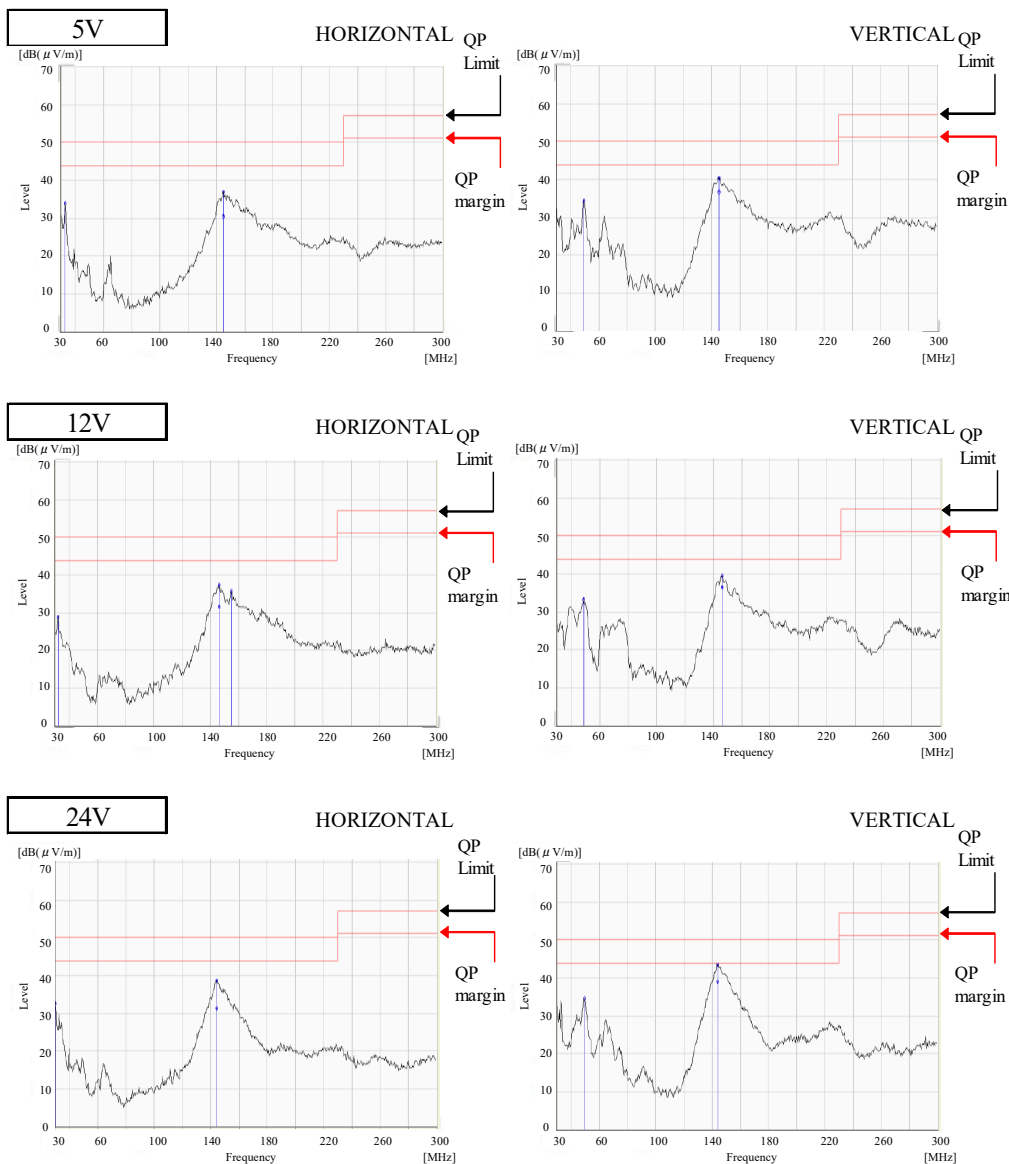

測定条件は測定回路6を参照

Measurement condition refer Circuit 6 used for determination.

EN55011-A,EN55032-Aの限界値はVCCI class Aの限界値と同じ
Limit of EN55011-A,EN55032-A are same as its VCCI class A.

表示はピーク値

Indication is peak values.

Conditions Vin : 110 VAC
Iout : Full load
Ta : 25°C

雑音電界強度
Radiated Emission

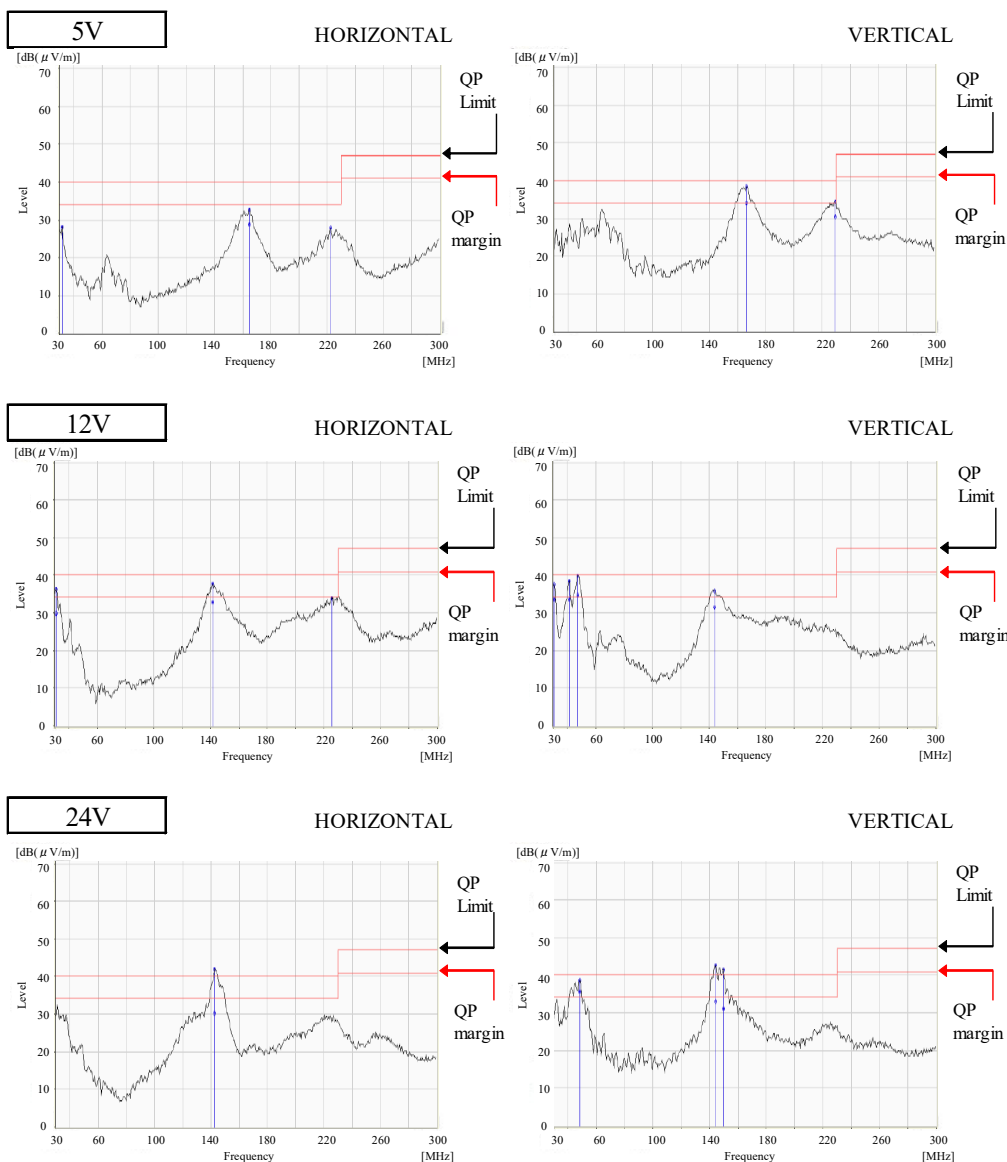

測定条件は測定回路6を参照

Measurement condition refer Circuit 6 used for determination.

EN55011-B,EN55032-Bの限界値はVCCI class Bの限界値と同じ

Limit of EN55011-B,EN55032-B are same as its VCCI class B.

表示はピーク値

Indication is peak values.