

**MTW60-51515**

**EVALUATION DATA**

**型式データ**

## INDEX

1.	測定方法	Evaluation Method	PAGE
1.1	測定回路	Circuit used for determination	
	測定回路1	Circuit 1 used for determination .....	T-1
	静特性	Steady state data	
	通電ドリフト特性	Warm up voltage drift characteristics	
	出力保持時間特性	Hold up time characteristics	
	出力立ち上がり特性	Output rise characteristics	
	出力立ち下がり特性	Output fall characteristics	
	過電流保護特性	Over current protection (OCP) characteristics	
	過電圧保護特性	Over voltage protection (OVP) characteristics	
	入力電圧瞬停特性	Response to brown out characteristics	
	測定回路2	Circuit 2 used for determination .....	T-1
	過渡応答 (負荷急変) 特性	Dynamic load response characteristics	
	測定回路3	Circuit 3 used for determination .....	T-2
	入力サージ電流 (突入電流) 波形	Inrush current waveform	
	測定回路4	Circuit 4 used for determination .....	T-2
	リーク電流特性	Leakage current characteristics	
	測定回路5	Circuit 5 used for determination .....	T-2
	出力リップル、ノイズ波形	Output ripple and noise waveform	
	測定構成	Configuration used for determination .....	T-3
	EMI特性	Electro-Magnetic Interference characteristics	
	雑音端子電圧 (帰還ノイズ)	Conducted Emission	
1.2	使用測定機器	List of equipment used .....	T-4

2. 特性データ Characteristics

2.1 静特性 Steady state data

(1) 入力・負荷・温度変動／出力起動・遮断電圧  
Regulation - line and load, Temperature drift / Start up voltage and Drop out voltage ..... T-5

(2) リップルノイズ電圧対入力電圧  
Ripple noise voltage vs. Input voltage ..... T-6

(3) 効率・力率対出力電流  
Efficiency and Power factor vs. Output current ..... T-7

(4) 入力電力対出力電流  
Input power vs. Output current ..... T-8

(5) 入力電流対出力電流  
Input current vs. Output current ..... T-8

2.2 通電ドリフト特性 Warm up voltage drift characteristics ..... T-9

2.3 出力保持時間特性 Hold up time characteristics ..... T-9

2.4 出力立ち上がり特性 Output rise characteristics ..... T-10

2.5 出力立ち下がり特性 Output fall characteristics ..... T-11

2.6 過電流保護特性 Over current protection (OCP) characteristics ..... T-12 ~ 13

2.7 過電圧保護特性 Over voltage protection (OVP) characteristics ..... T-14

2.8 過渡応答（負荷急変）特性 Dynamic load response characteristics ..... T-15

2.9 入力電圧瞬停特性 Response to brown out characteristics ..... T-16

2.10 入力サージ電流（突入電流）波形 Inrush current waveform ..... T-17

2.11 リーク電流特性 Leakage current characteristics ..... T-18

2.12 出力リップル、ノイズ波形 Output ripple and noise waveform ..... T-19

2.13 EMI特性 Electro-Magnetic Interference characteristics ..... T-20 ~ 21

使用記号 Terminology used

	定義	Definition
V <sub>in</sub>	..... 入力電圧	Input voltage
V <sub>out</sub>	..... 出力電圧	Output voltage
I <sub>in</sub>	..... 入力電流	Input current
I <sub>out</sub>	..... 出力電流	Output current
T <sub>a</sub>	..... 周囲温度	Ambient temperature
f	..... 周波数	Frequency

※ 弊社測定条件における結果であり、参考値としてお考え願います。  
Test results are reference data based on our measurement condition.

1. 測定方法 Evaluation Method

1.1 測定回路 Circuit used for determination

測定回路1 Circuit 1 used for determination

- ・ 静特性 Steady state data
- ・ 通電ドリフト特性 Warm up voltage drift characteristics
- ・ 出力保持時間特性 Hold up time characteristics
- ・ 出力立ち上がり特性 Output rise characteristics
- ・ 出力立ち下がり特性 Output fall characteristics
- ・ 過電流保護特性 Over current protection (OCP) characteristics
- ・ 過電圧保護特性 Over voltage protection (OVP) characteristics
- ・ 入力電圧瞬停特性 Response to brown out characteristics

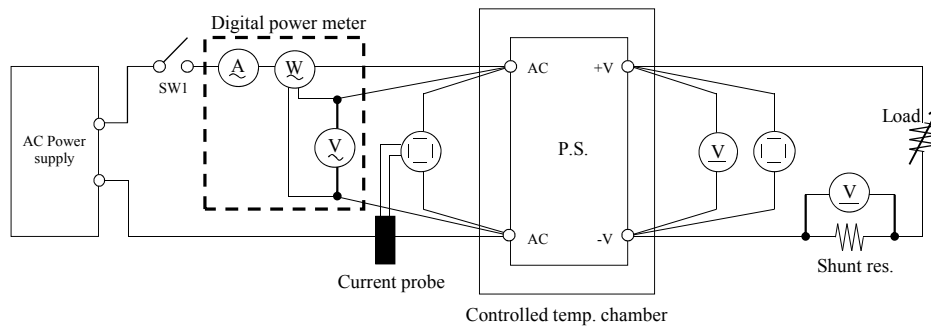

測定回路2 Circuit 2 used for determination

- ・ 過渡応答 (負荷急変) 特性 Dynamic load response characteristics

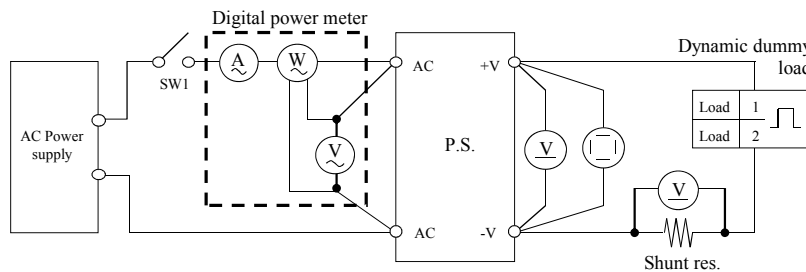

Output current waveform

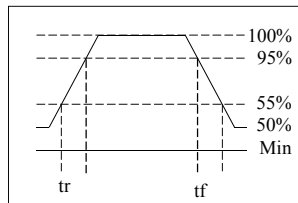

測定回路3 Circuit 3 used for determination

- ・入力サージ電流（突入電流）波形 Inrush current waveform

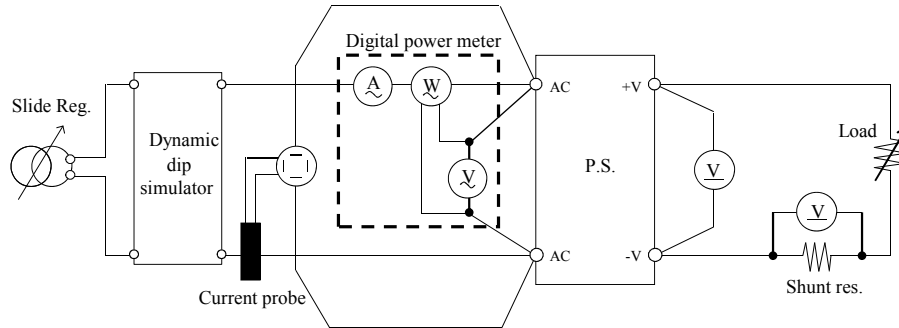

測定回路4 Circuit 4 used for determination

- ・リーク電流特性 Leakage current characteristics

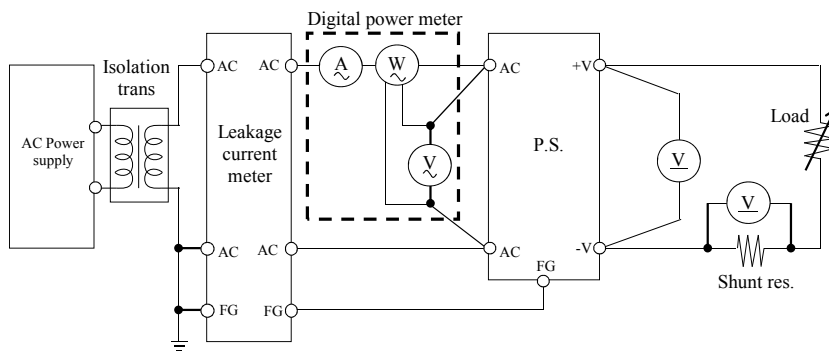

測定回路5 Circuit 5 used for determination

- ・出力リップル、ノイズ波形 Output ripple and noise waveform

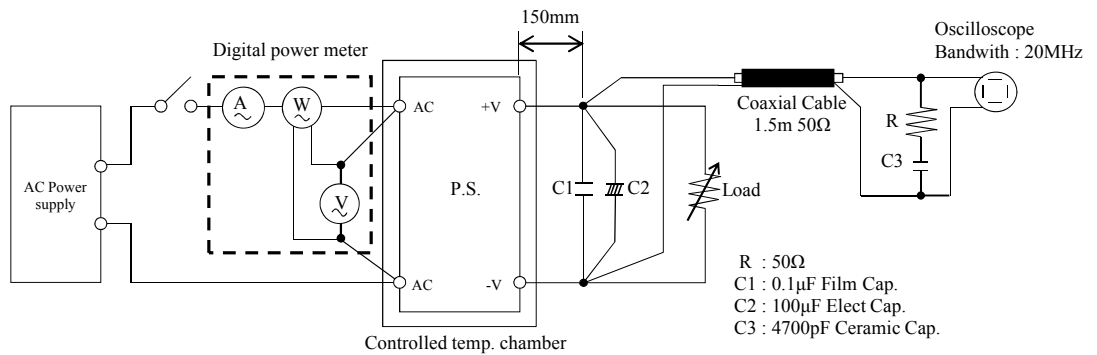

測定構成 Configuration used for determination

- EMI特性 Electro-Magnetic Interference characteristics

雑音端子電圧 (帰還ノイズ)

Conducted Emission

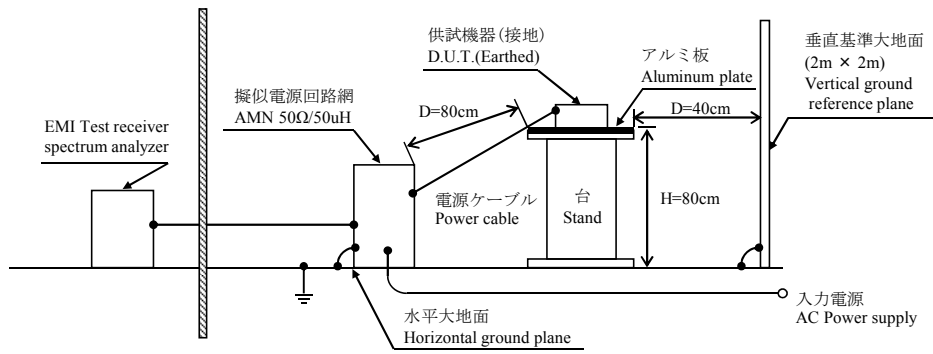

## 1.2 使用測定機器 List of equipment used

	EQUIPMENT USED	MANUFACTURER	MODEL NO.
1	DIGITAL STORAGE OSCILLOSCOPE	YOKOGAWA ELECT.	DL1740 / DL9040L / DLM2054
2	DIGITAL MULTIMETER	AGILENT	34970A
3	DIGITAL POWER METER	YOKOGAWA ELECT.	WT210
4	CONTROLLED TEMP. CHAMBER	ESPEC	SH-240S1
5	DYNAMIC DUMMY LOAD	TAKASAGO	FK-200L / FK-400L
6	DUMMY LOAD	PCN	PHF250 SERIES
7	CURRENT PROBE	YOKOGAWA ELECT.	701928 / 701930
8	AC POWER SUPPLY	TAKASAGO	AA2000XG
9	AC POWER SUPPLY	KIKUSUI	PCR2000L / PCR4000L
10	SHUNT RESISTOR	YOKOGAWA	MODEL 2215
11	SHUNT RESISTOR	DAIICHI ELECT.	TYPE DS
12	LEAKAGE CURRENT METER	HIOKI	3156
13	DYNAMIC DIP SIMULATOR	TAKAMISAWA	PSA-210
14	ISOLATION TRANS	TOYO ELECT.	LCC-B-1000
15	SLIDE REGULATOR	MATSUNAGA	SD-2450
16	EMI TEST RECEIVER / SPECTRUM ANALYZER	ROHDE & SCHWARZ	ESCI3
17	PRE AMP.	HEWLETT-PACKARD	8447D OPT 010
18	AMN	SCHWARZBECK	NNLK8121
19	ANTENNA	SCHWARZBECK	BBA9106 / UHALP9107

2. 特性データ Characteristics

2.1 静特性 Steady state data

(1) 入力・負荷・温度変動／出力起動・遮断電圧

Regulation - line and load, Temperature drift / Start up voltage and Drop out voltage

・測定条件 Measuring Condition : 出力電圧、電流 Output voltage & current

Iout \ Vout	V1 : 5V	V2 : 15V	V3 : -15V
Min Load	0.0A	0.0A	0.0A
100%	5.0A	2.0A	0.5A

1. Regulation - line and load

Condition Ta : 25 °C

V1 : 5V

Iout \ Vin	85VAC	100VAC	200VAC	265VAC	Line regulation	
Min Load	5.042V	5.042V	5.042V	5.042V	0mV	0.000%
50%	5.043V	5.043V	5.043V	5.043V	0mV	0.000%
100%	5.042V	5.042V	5.042V	5.042V	0mV	0.000%
Load regulation	1mV	1mV	1mV	1mV		
	0.020%	0.020%	0.020%	0.020%		

V2 : 15V

Iout \ Vin	85VAC	100VAC	200VAC	265VAC	Line regulation	
Min Load	14.907V	14.908V	14.907V	14.907V	1mV	0.007%
50%	14.911V	14.911V	14.911V	14.911V	0mV	0.000%
100%	14.911V	14.912V	14.912V	14.912V	1mV	0.007%
Load regulation	4mV	4mV	5mV	5mV		
	0.027%	0.027%	0.033%	0.033%		

V3 : -15V

Iout \ Vin	85VAC	100VAC	200VAC	265VAC	Line regulation	
Min Load	-15.034V	-15.035V	-15.036V	-15.036V	2mV	0.013%
50%	-15.006V	-15.007V	-15.008V	-15.009V	3mV	0.020%
100%	-14.979V	-14.979V	-14.979V	-14.979V	0mV	0.000%
Load regulation	55mV	56mV	57mV	57mV		
	0.367%	0.373%	0.380%	0.380%		

2. Temperature drift

Conditions Vin : 100 VAC

Iout : 100 %

V1 : 5V

Ta	-10°C	+25°C	+50°C	Temperature stability	
Vout	5.018V	5.042V	5.042V	24mV	0.480%

V2 : 15V

Ta	-10°C	+25°C	+50°C	Temperature stability	
Vout	14.783V	14.912V	14.907V	129mV	0.860%

V3 : -15V

Ta	-10°C	+25°C	+50°C	Temperature stability	
Vout	-15.024V	-14.979V	-14.911V	113mV	0.753%

3. Start up voltage and Drop out voltage

Conditions Ta : 25 °C

Iout : 100 %

Start up voltage (Vin)	46VAC
Drop out voltage (Vin)	37VAC



(2) リップルノイズ電圧対入力電圧

Ripple noise voltage vs. Input voltage

Conditions Iout : 100 %  
 Ta : -10 °C ---  
 25 °C - - -  
 50 °C —

V1 : 5V

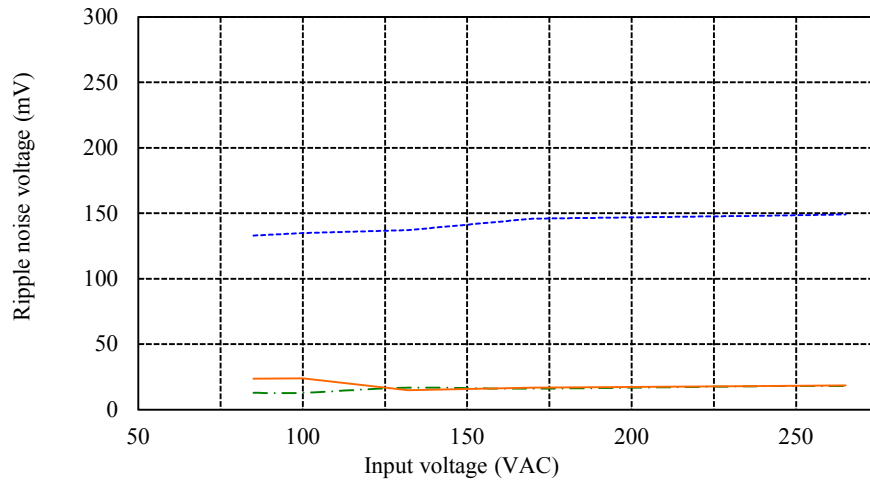

V2 : 15V

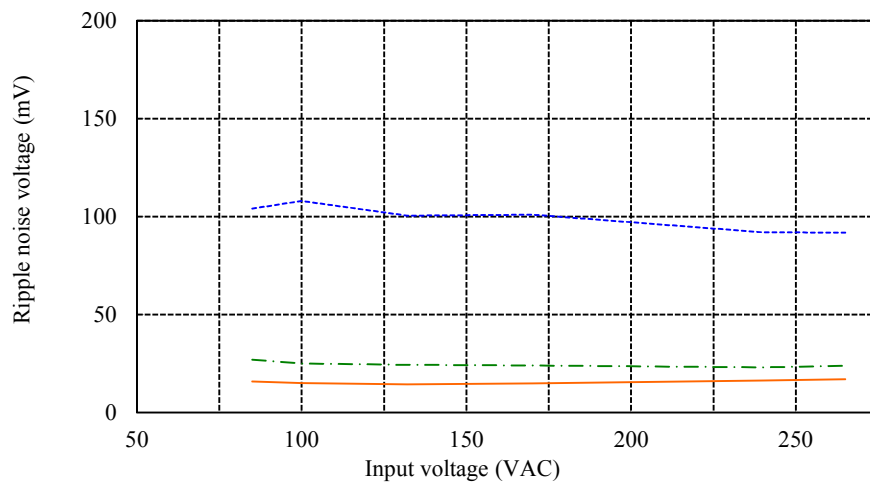

V3 : -15V

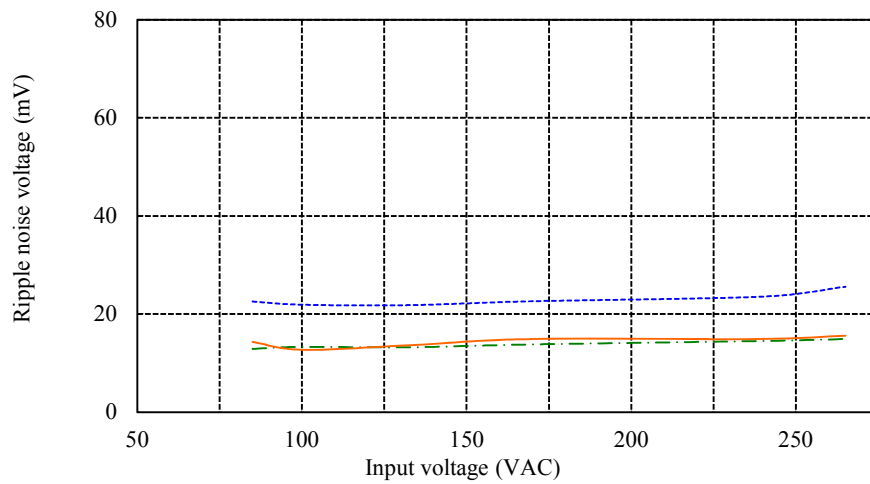

(3) 効率・力率対出力電流

Efficiency and Power factor vs. Output current

Conditions Vin : 85 VAC ---  
 100 VAC - - -  
 200 VAC ———  
 265 VAC - · - · -  
 Ta : 25 °C

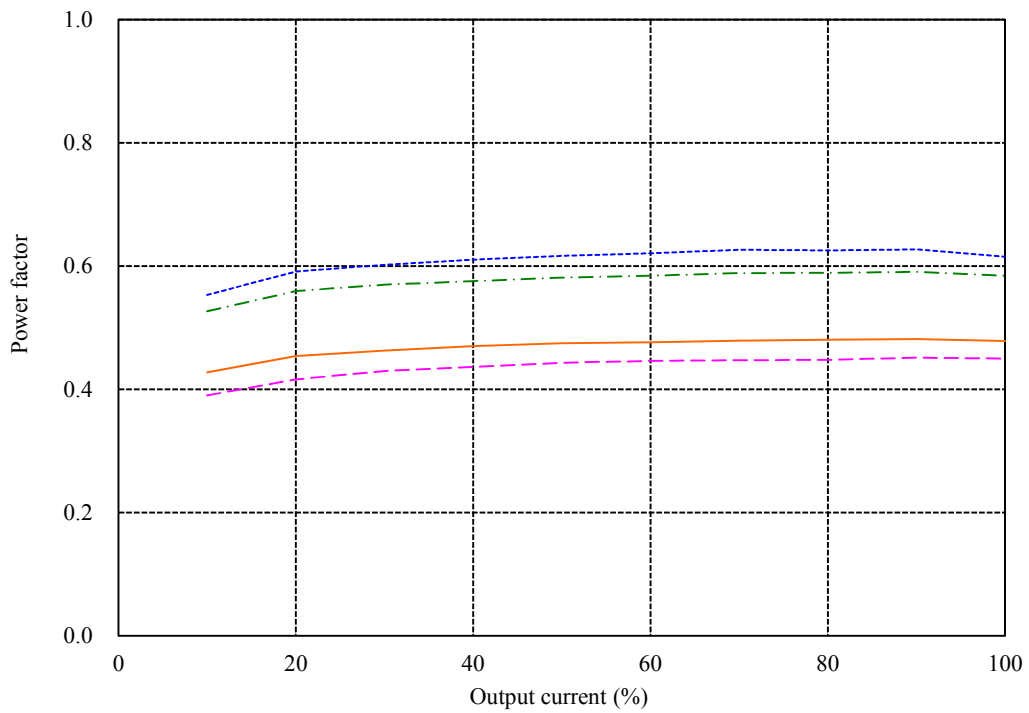
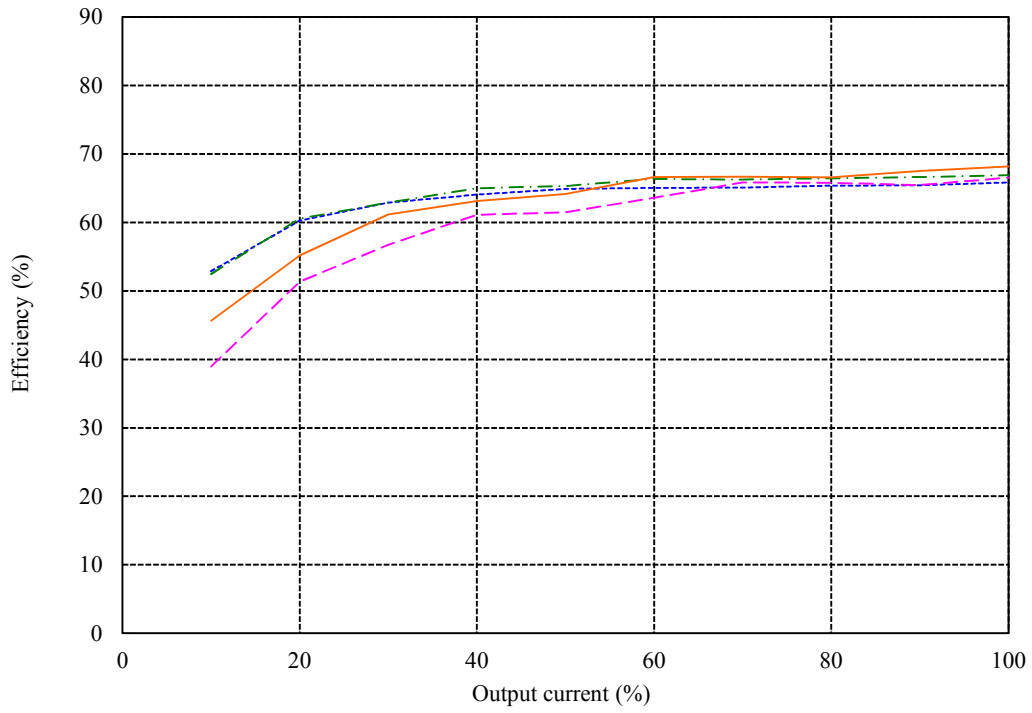

(4) 入力電力対出力電流

Input power vs. Output current

Vin	Input power
	Iout : 0%
85VAC	1.75W
100VAC	1.78W
200VAC	2.43W
265VAC	4.50W

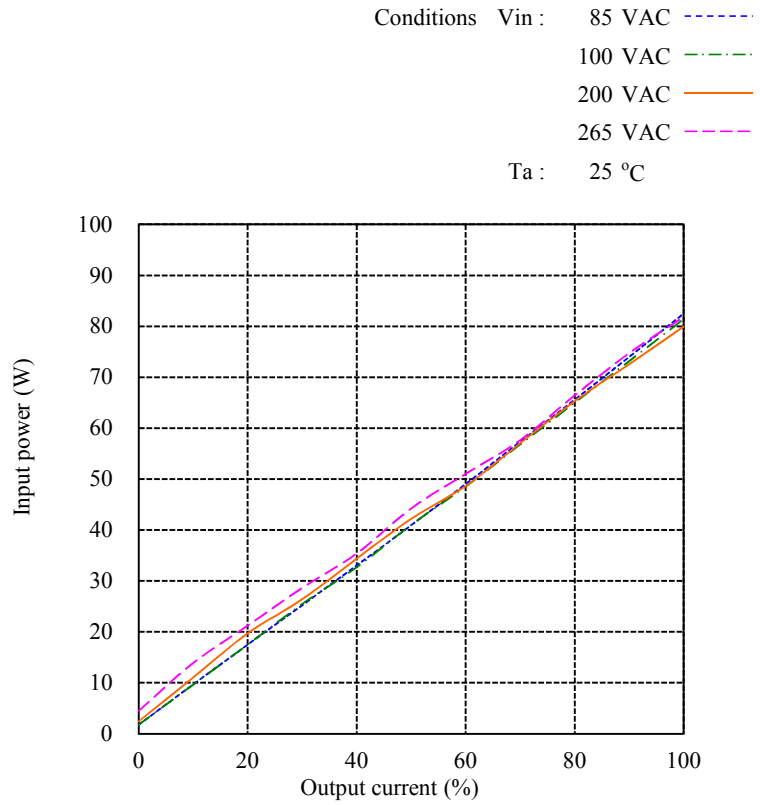

(5) 入力電流対出力電流

Input current vs. Output current

Vin	Input current
	Iout : 0%
85VAC	0.06A
100VAC	0.06A
200VAC	0.05A
265VAC	0.07A

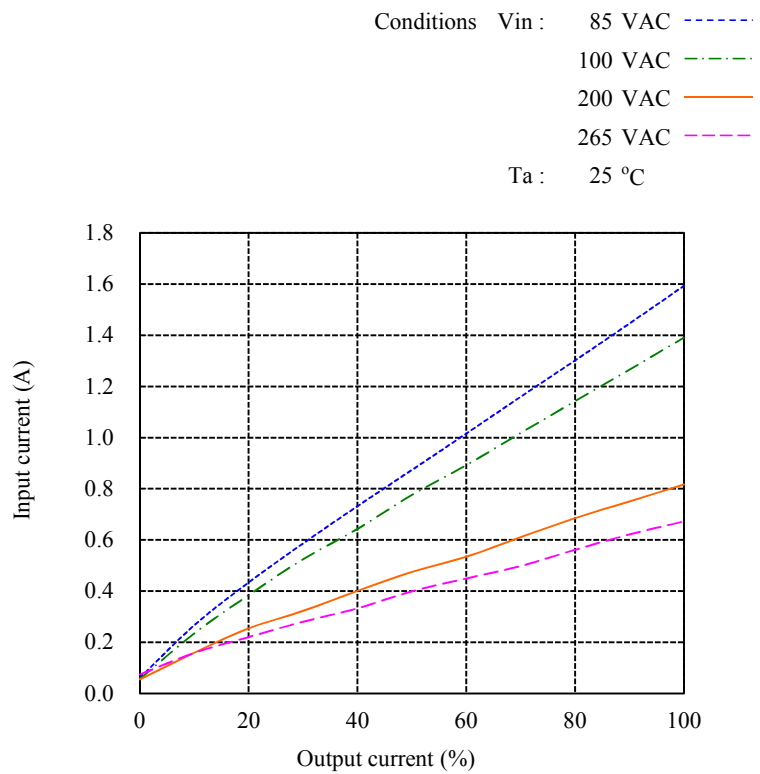

2.2 通電ドリフト特性

Warm up voltage drift characteristics

Conditions Vin : 100 VAC  
Iout : 100 %  
Ta : 25 °C

V1 : 5V

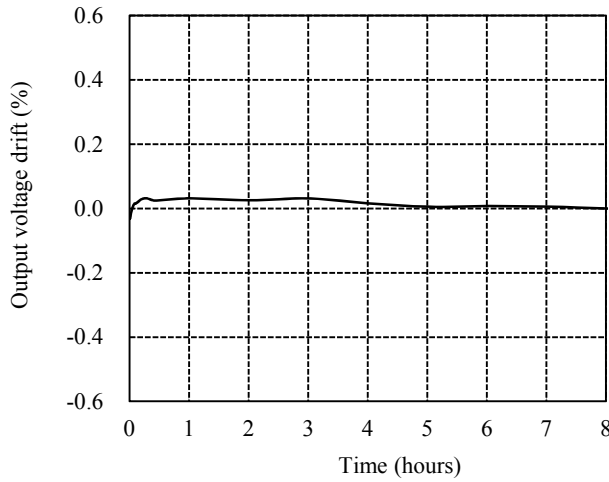

V2 : 15V

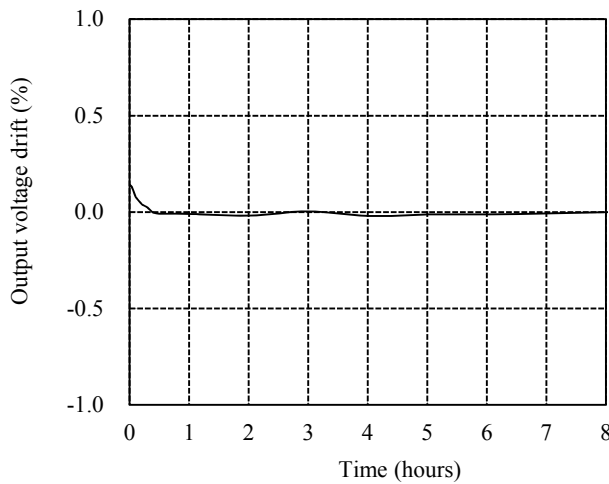

V3 : -15V

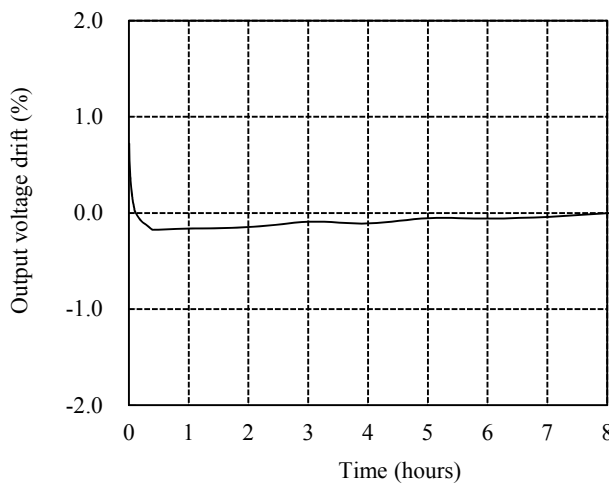

2.3 出力保持時間特性

Hold up time characteristics

Conditions Vin : 100 VAC  
Ta : 25 °C

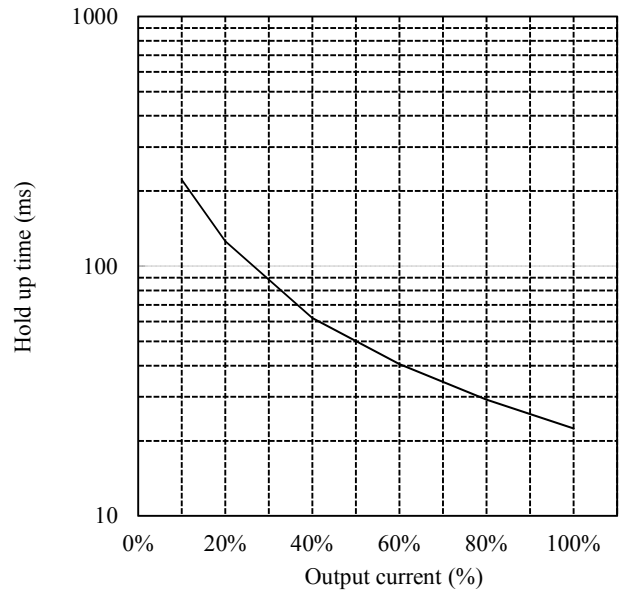

Conditions Vin : 240 VAC  
Ta : 25 °C

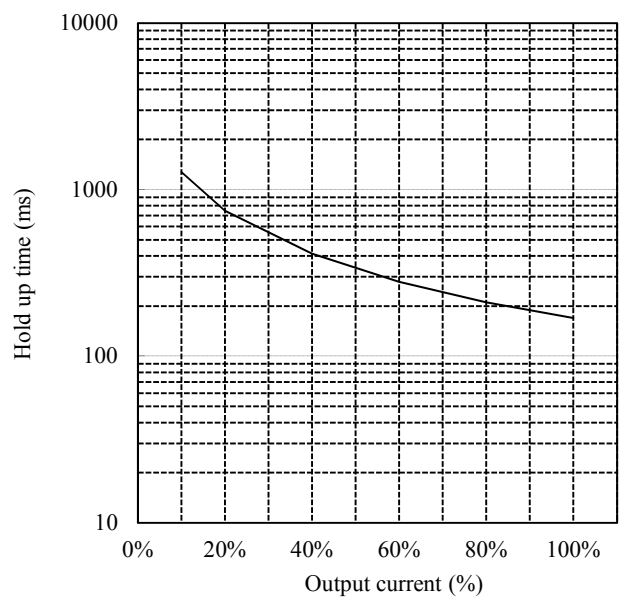

2.4 出力立ち上がり特性

Output rise characteristics

Conditions Ta : 25 °C

Vin = 100VAC

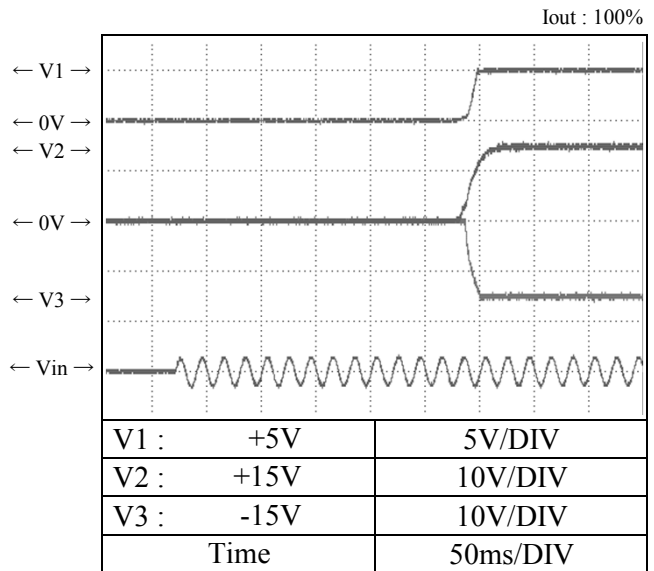
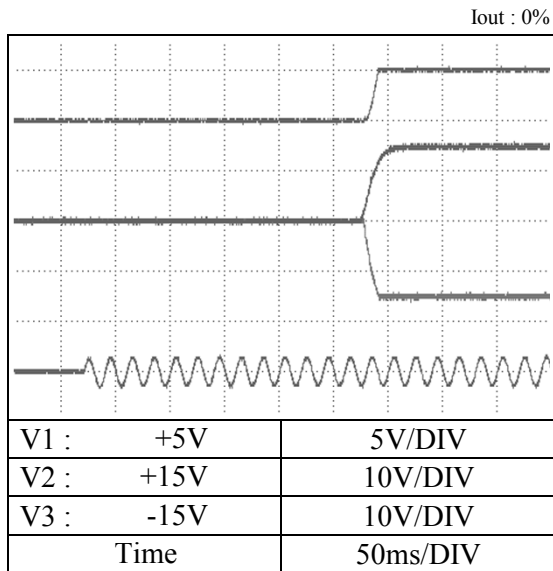

Vin = 240VAC

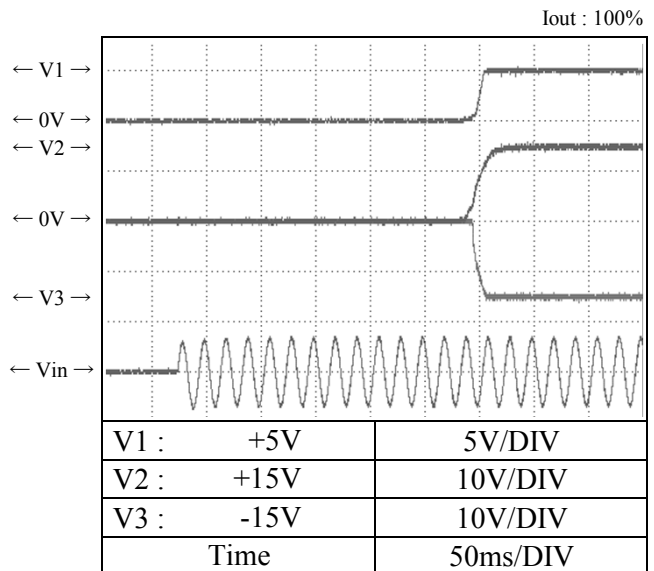
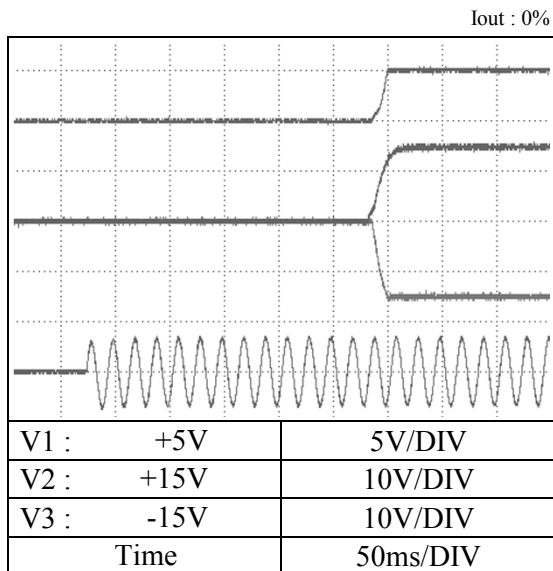

2.5 出力立ち下がり特性

Output fall characteristics

Conditions Ta : 25 °C

Vin = 100VAC

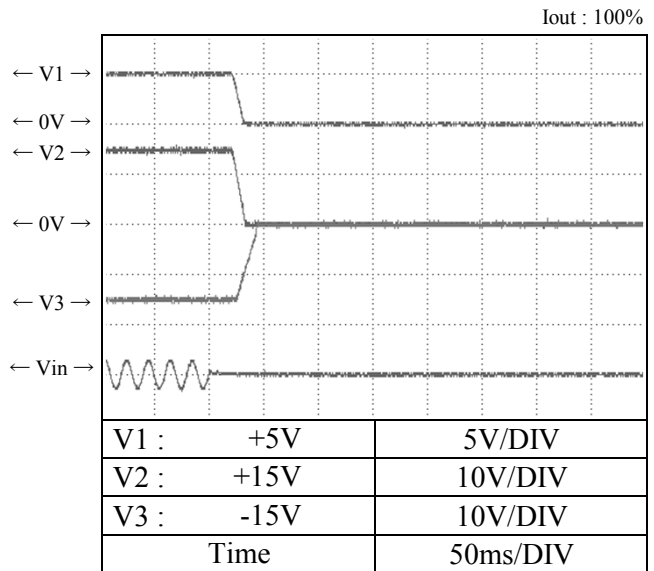
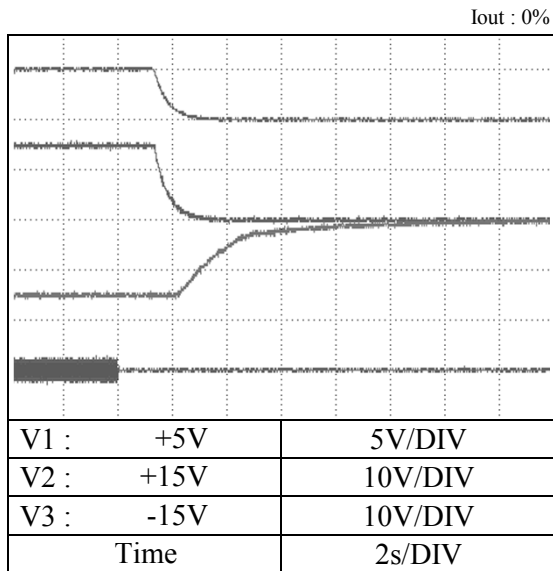

Vin = 240VAC

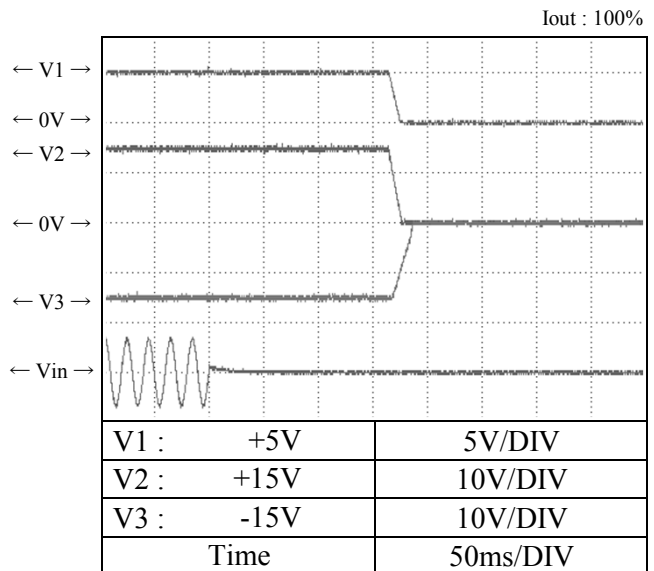
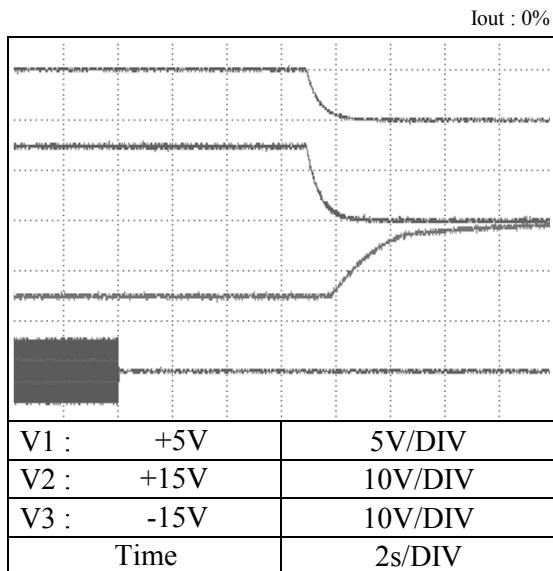

2.6 過電流保護特性

Over current protection (OCP) characteristics

Conditions Vin : 100 VAC  
 Ta : -10 °C ---  
 25 °C - - -  
 50 °C ———

V1 : 5V

V2, V3 : Io = 100%

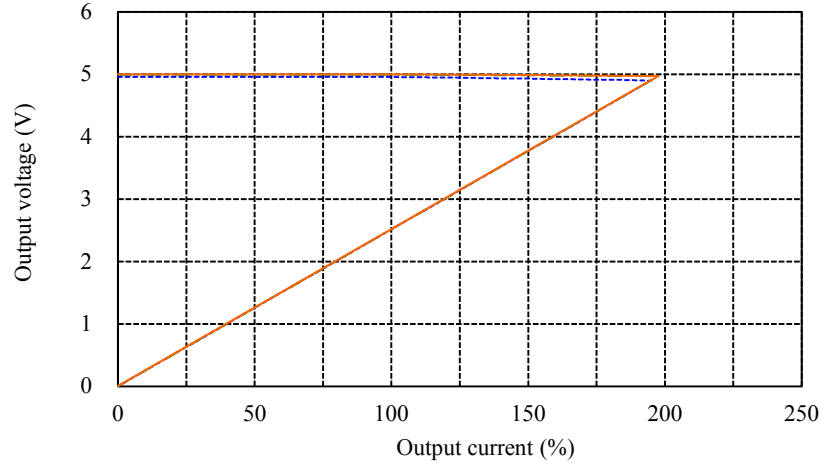

V2 : 15V

V1, V3 : Io = 100%

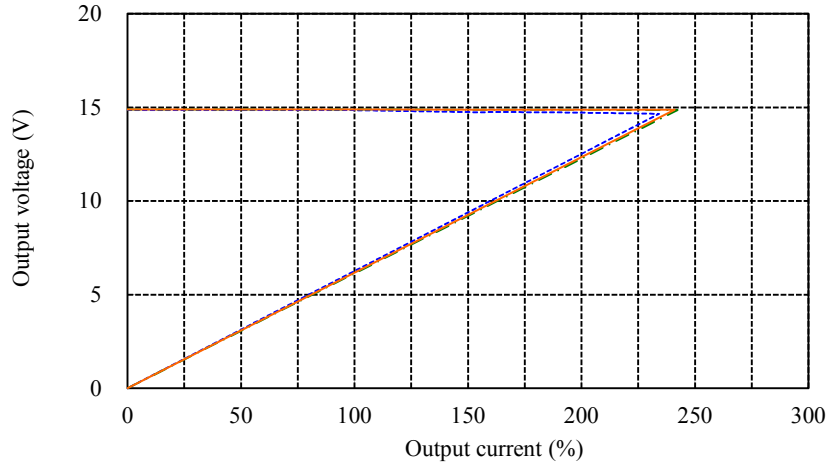

V3 : -15V

V1, V2 : Io = 100%

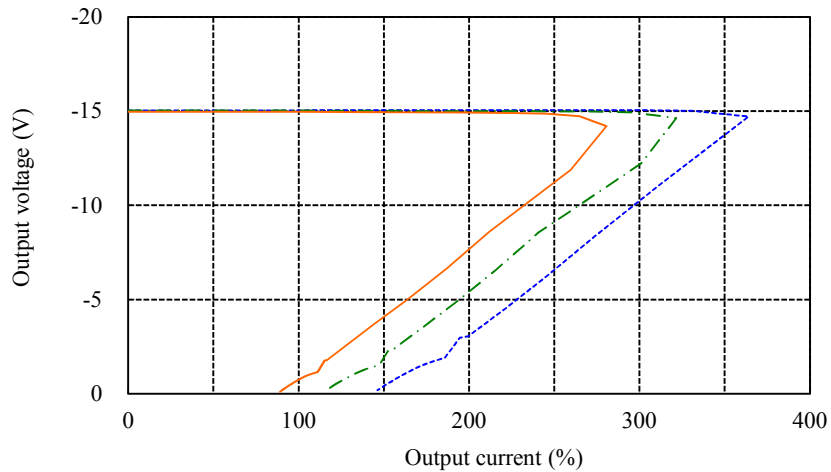

2.6 過電流保護特性

Over current protection (OCP) characteristics

Conditions Vin : 85 VAC ———  
 100 VAC - - - -  
 240 VAC - · - · -  
 265 VAC ———  
 Ta : 25 °C

V1 : 5V

V2, V3 : Io = 100%

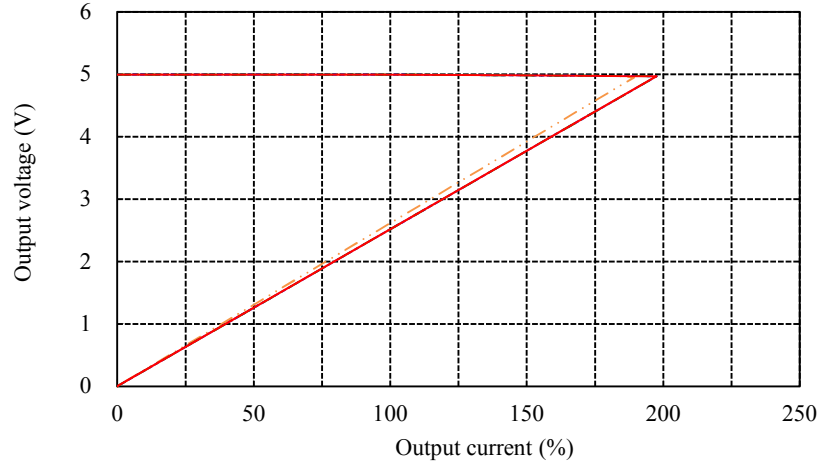

V2 : 15V

V1, V3 : Io = 100%

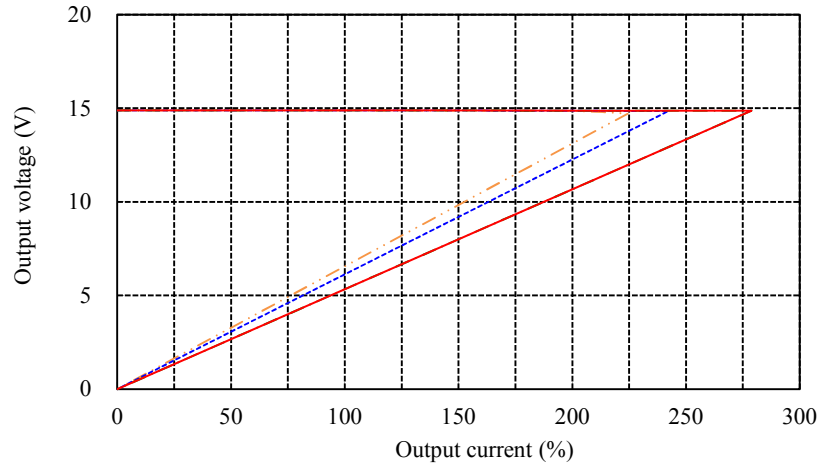

V3 : -15V

V1, V2 : Io = 100%

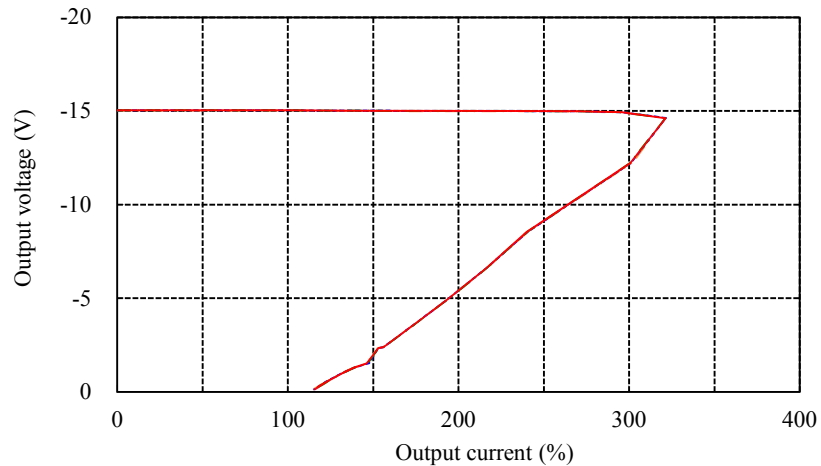



2.7 過電圧保護特性

Over voltage protection (OVP) characteristics

Conditions Ta : 25 °C

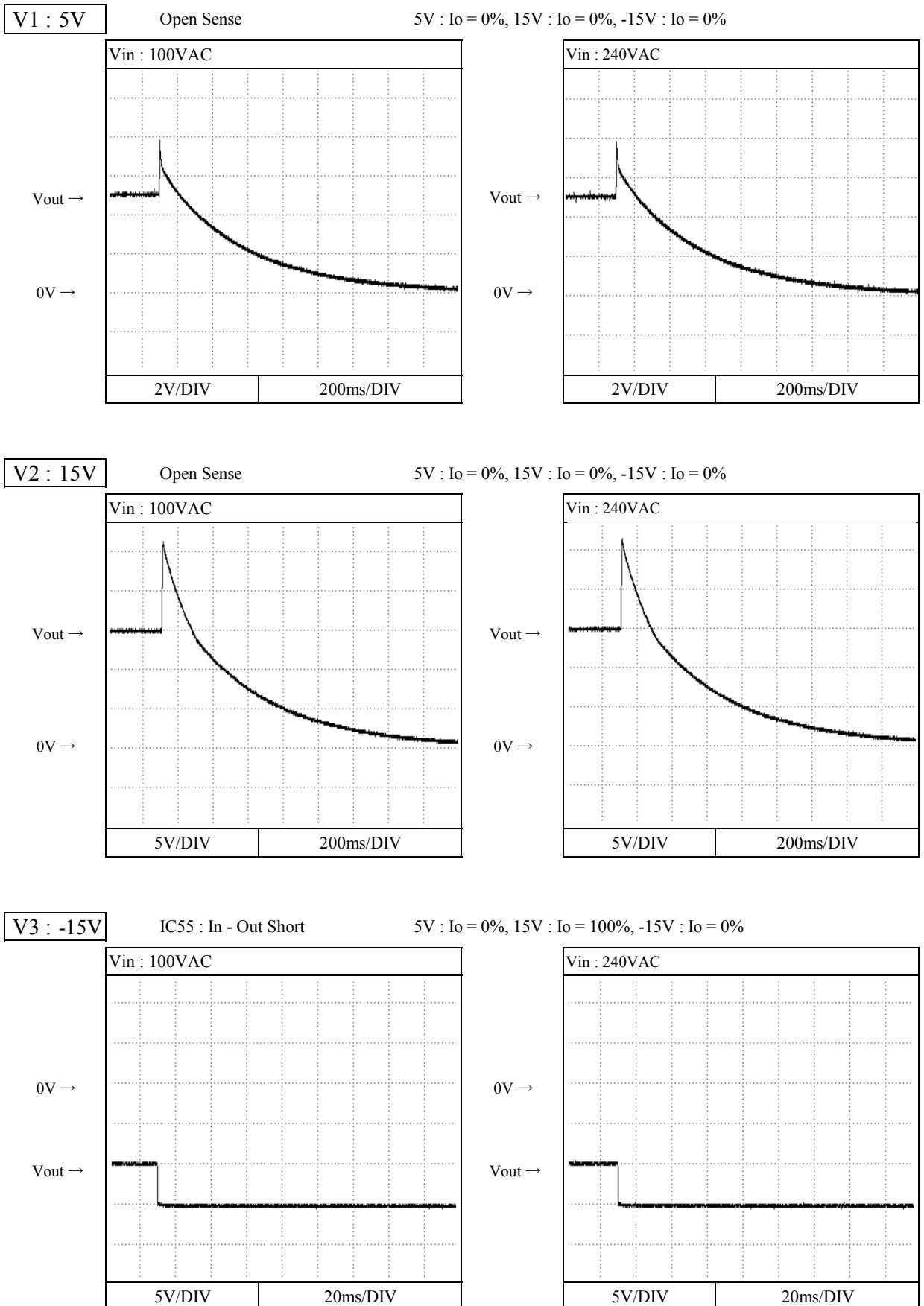

2.9 過渡応答（負荷急変）特性

Dynamic load response characteristics

Conditions Vin : 100 VAC  
Ta : 25 °C

**V1 : 5V** Io (V1) : 50% ↔ 100% (tr = tf = 50μs) f = 100Hz

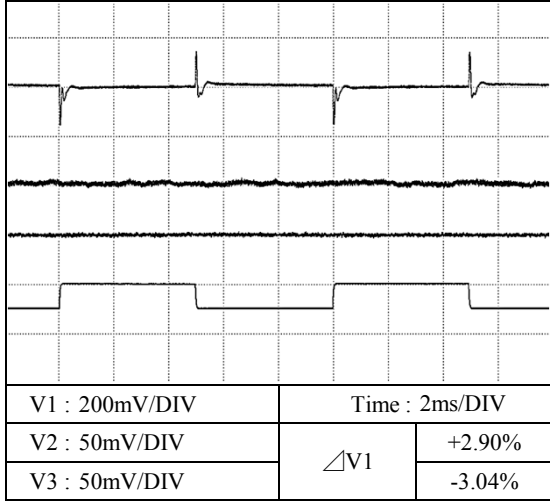

Io (V2) : 100% Io (V3) : 100% f = 1kHz

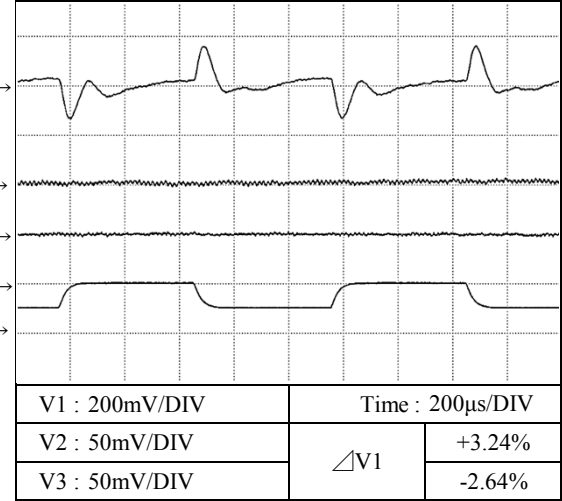

**V2 : 15V** Io (V1) : 100% Io (V2) : 50% ↔ 100% (tr = tf = 50μs) f = 100Hz

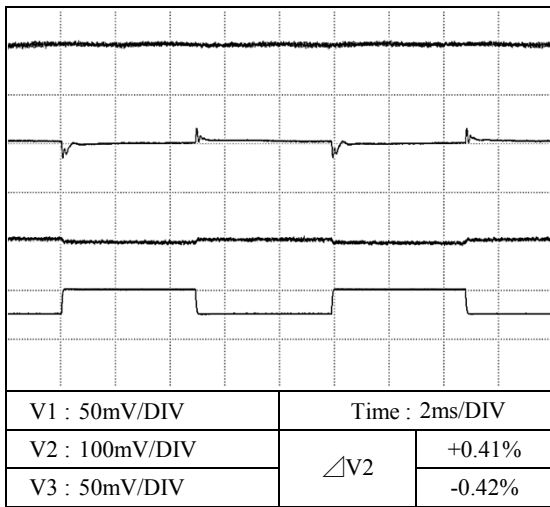

Io (V3) : 100% f = 1kHz

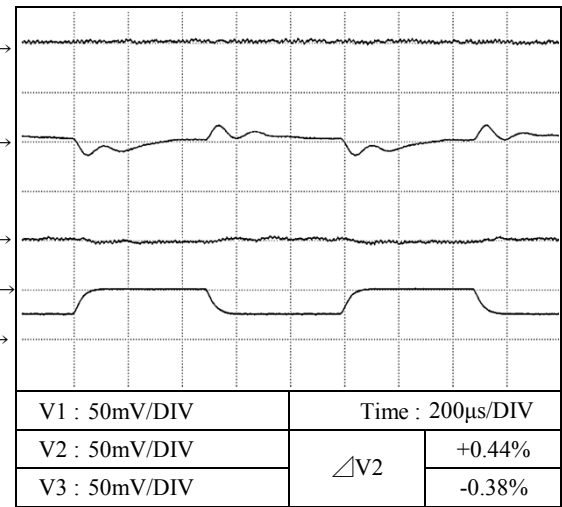

**V3 : -15V** Io (V1) : 100% Io (V2) : 100% Io (V3) : 50% ↔ 100% (tr = tf = 50μs) f = 100Hz

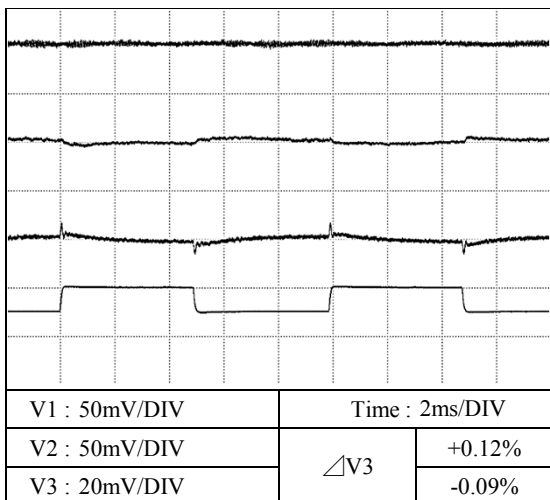

f = 1kHz

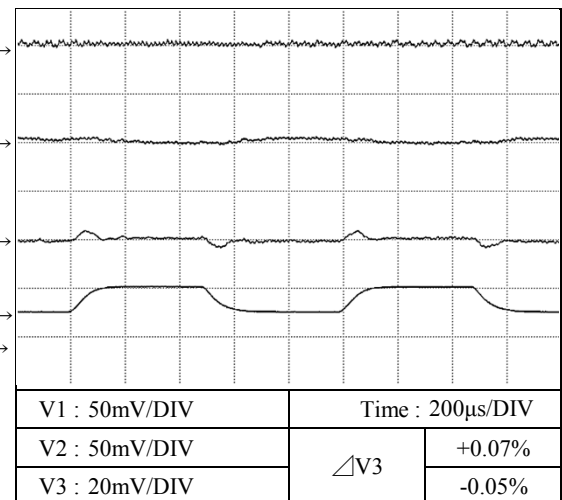

2.10 入力電圧瞬停特性

Response to brown out characteristics

Conditions Iout : 100 %  
Ta : 25 °C

Vin = 100VAC

Vin = 240VAC

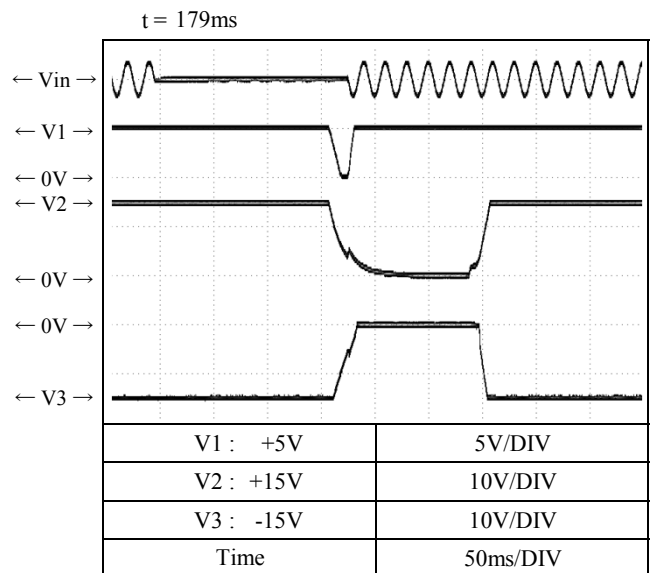
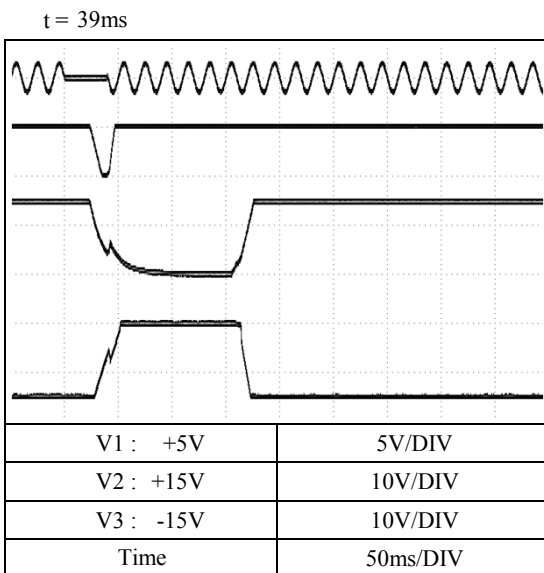
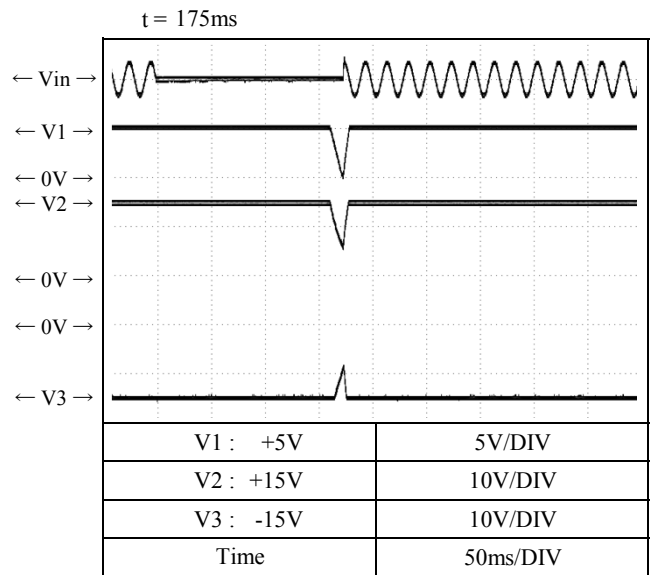
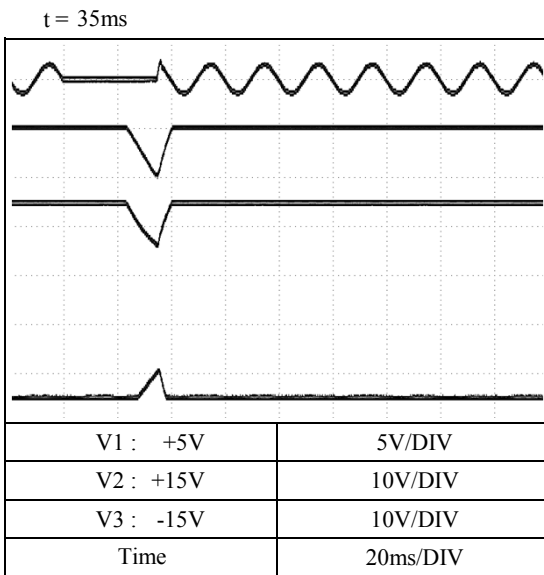
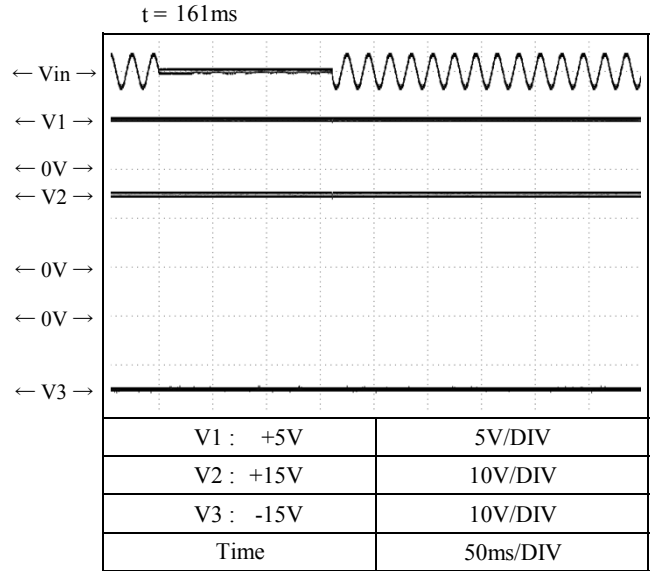
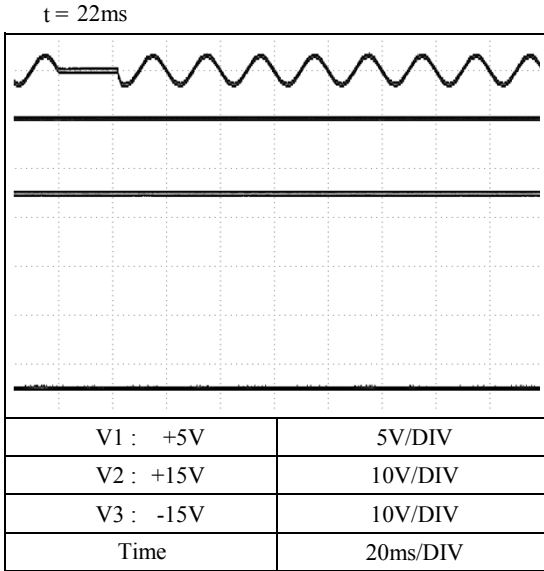

2.11 入力サージ電流（突入電流）波形

Inrush current waveform

Conditions Iout : 100 %  
Ta : 25 °C

Vin = 100VAC

Switch on phase angle of input AC voltage  
 $\phi = 0^\circ$

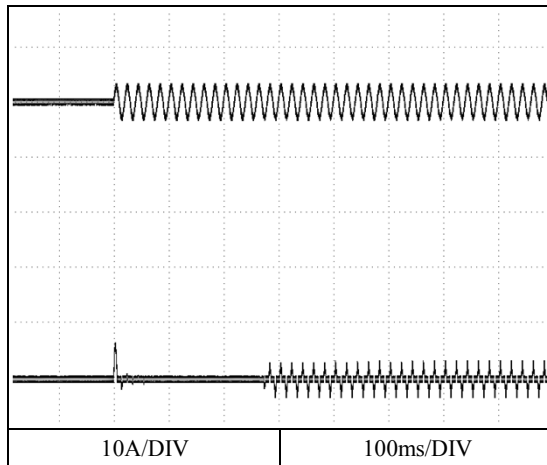

Switch on phase angle of input AC voltage  
 $\phi = 90^\circ$

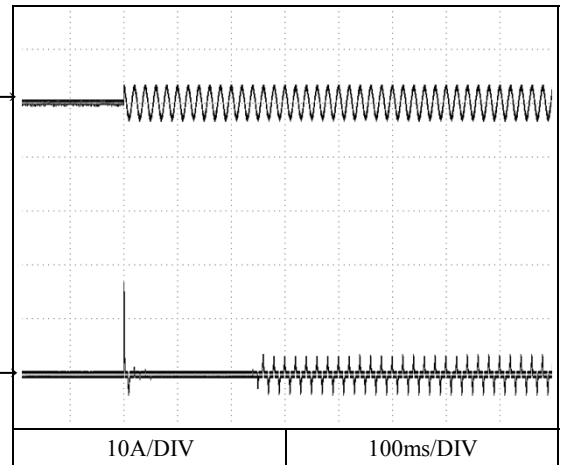

Vin = 240VAC

Switch on phase angle of input AC voltage  
 $\phi = 0^\circ$

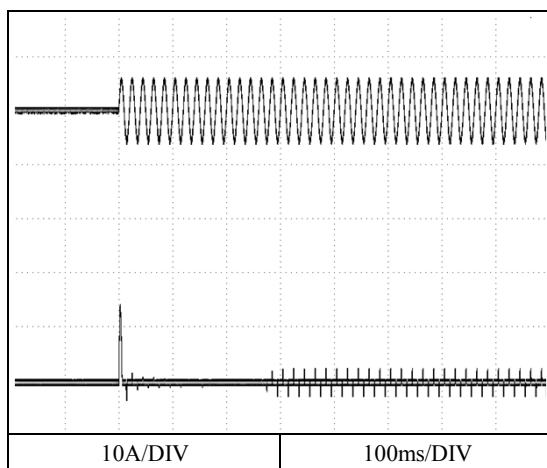

Switch on phase angle of input AC voltage  
 $\phi = 90^\circ$

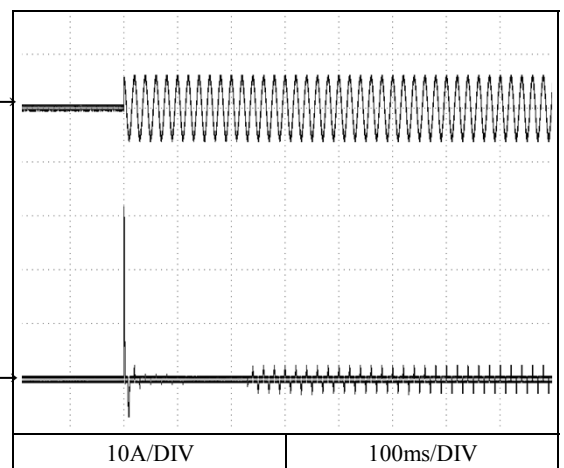

2.12 リーク電流特性

Leakage current characteristics

Conditions Iout : 0 % ———  
 100 % - - - - -  
 Ta : 25 °C  
 Equipment used : 3156 (HIOKI)

f : 50 Hz

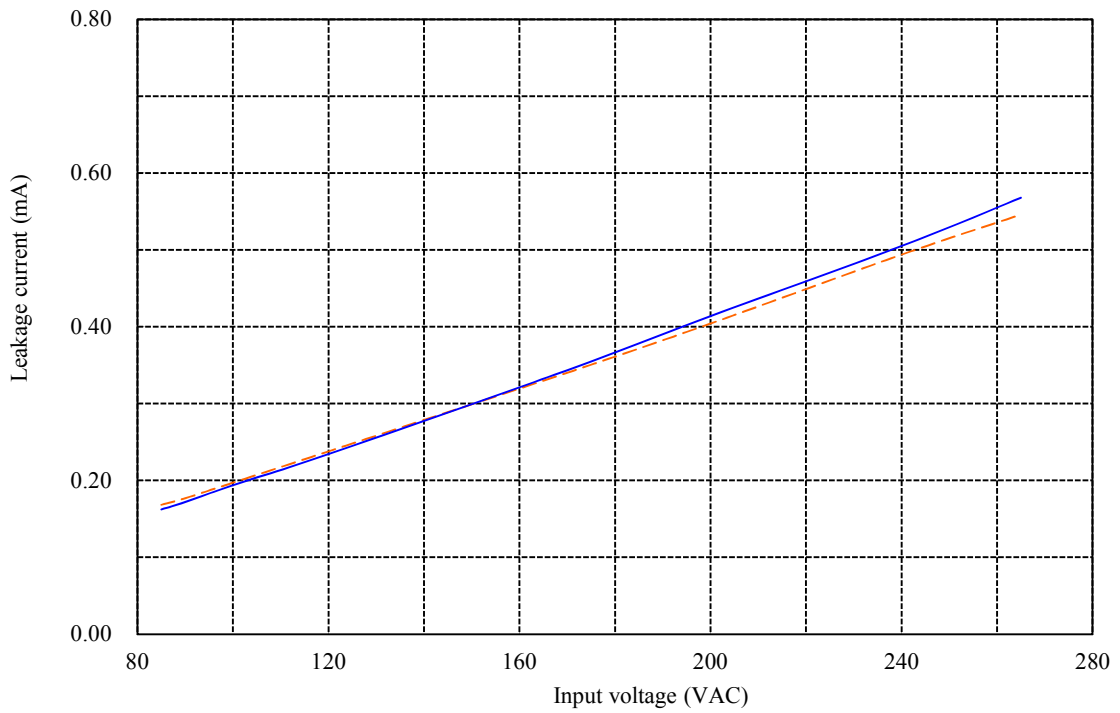

f : 60 Hz

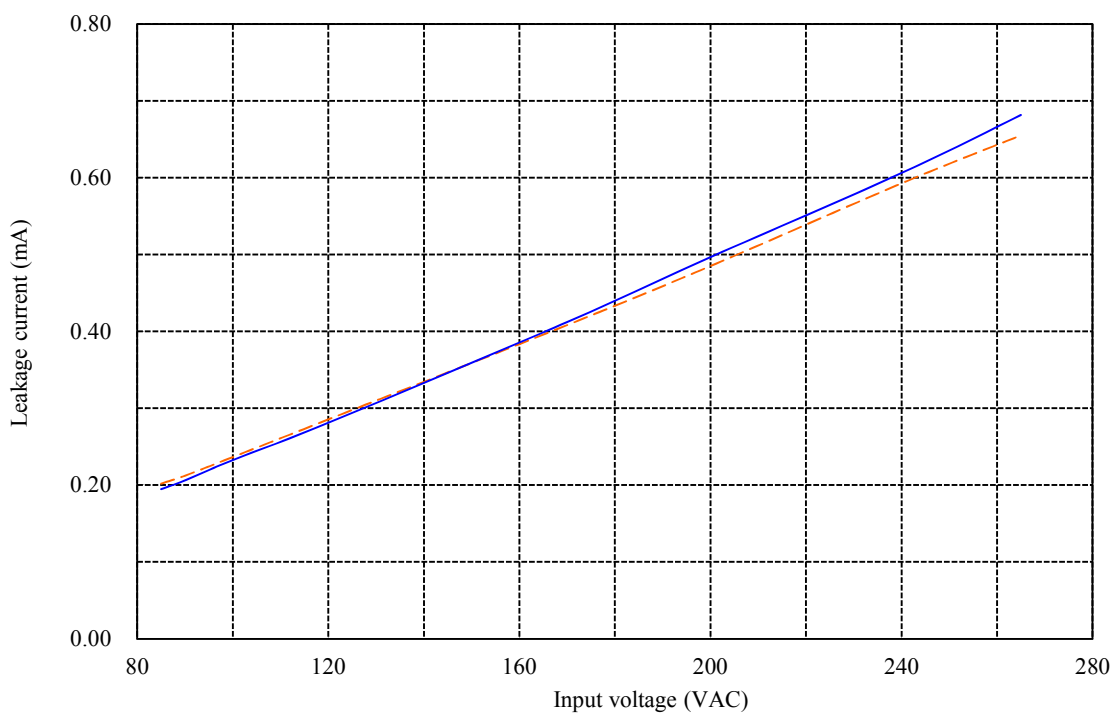

2.13 出力リップル、ノイズ波形

Output ripple and noise waveform

Conditions Vin : 100 VAC  
Iout : 100 %  
Ta : 25 °C

V1 : 5V

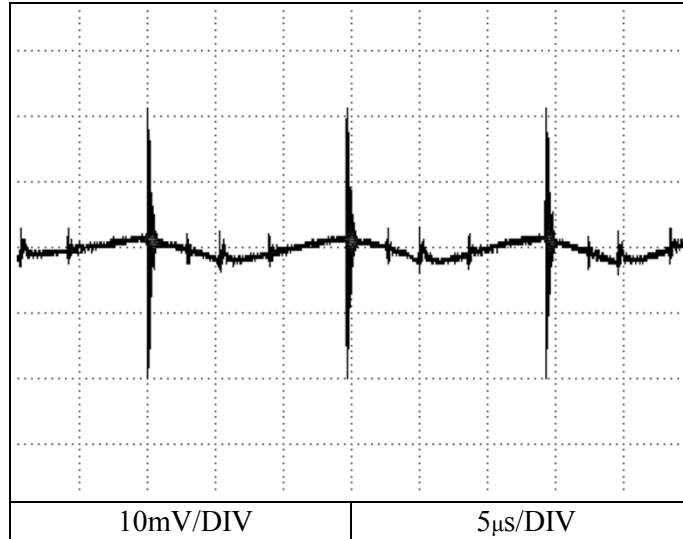

V2 : 15V

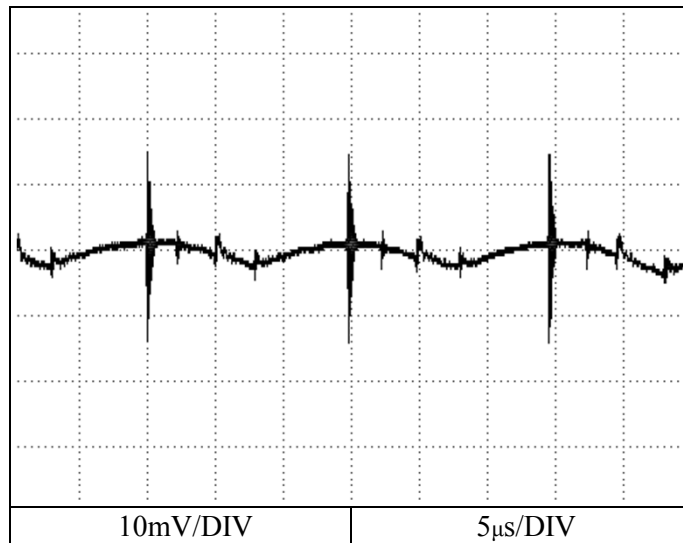

V3 : -15V

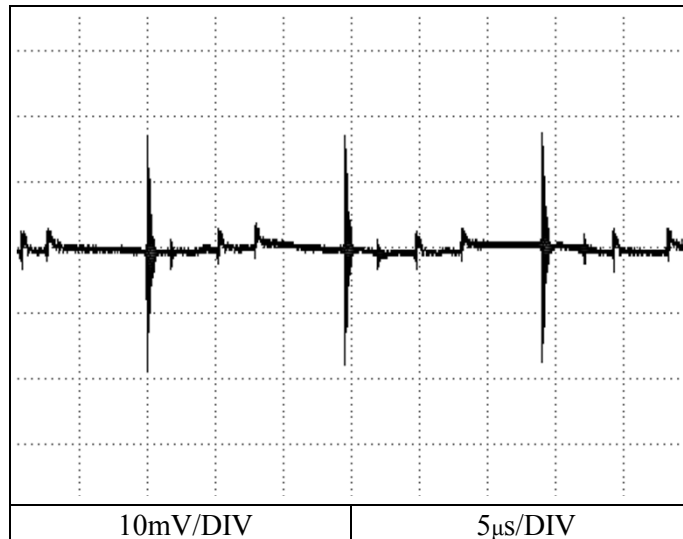

2.14 EMI 特性

Electro-Magnetic Interference characteristics

Conditions Vin : 100 VAC

Iout : 100 %

Ta : 25 °C

雑音端子電圧

Conducted Emission

Point A (259kHz)		
Ref. Data	Limit (dB)	Measure (dB)
QP	61.5	44.9
AV	51.5	29.7

Point B (24.59MHz)		
Ref. Data	Limit (dB)	Measure (dB)
QP	60.0	42.2
AV	50.0	34.7

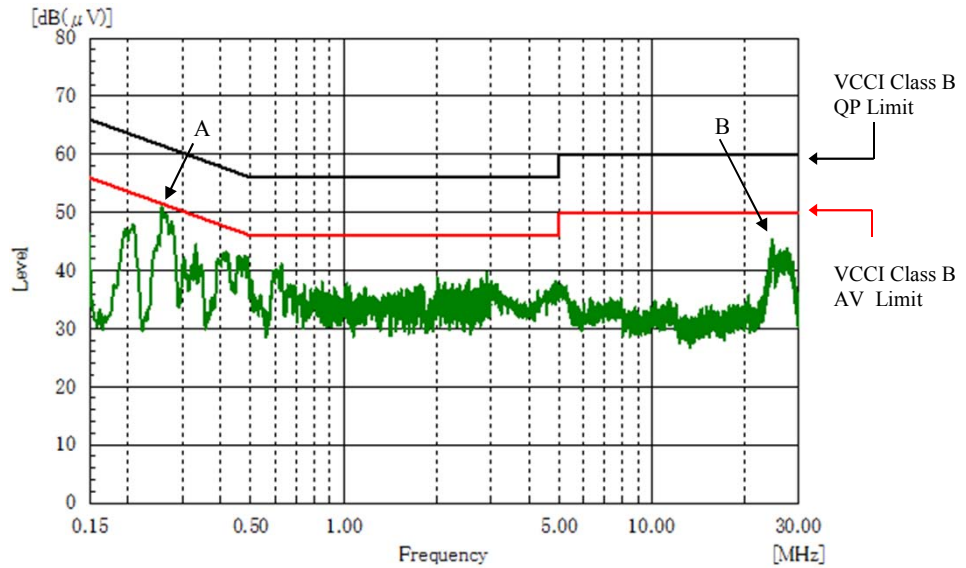

Point C (258kHz)		
Ref. Data	Limit (dB)	Measure (dB)
QP	61.5	45.2
AV	51.5	30.2

Point D (24.67MHz)		
Ref. Data	Limit (dB)	Measure (dB)
QP	60.0	41.3
AV	50.0	33.8

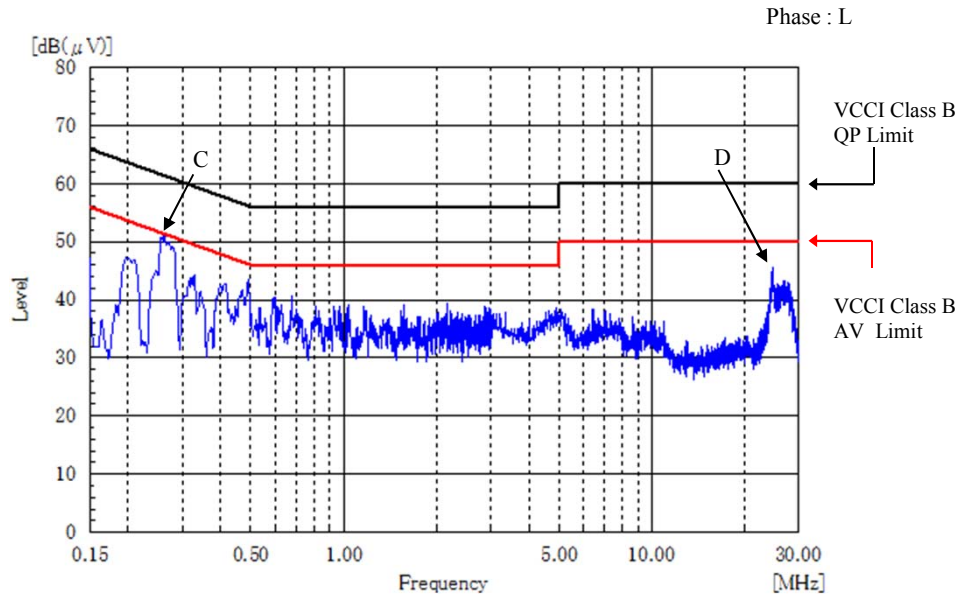

EN55011-B,EN55022-B,FCC-Bの限界値はVCCI class Bの限界値と同じ

Limit of EN55011-B,EN55022-B,FCC-B are same as its VCCI class B.

2.14 EMI 特性

Electro-Magnetic Interference characteristics

Conditions Vin : 230 VAC

Iout : 100 %

Ta : 25 °C

雑音端子電圧

Conducted Emission

Point A (193kHz)		
Ref. Data	Limit (dB)	Measure (dB)
QP	63.9	52.2
AV	53.9	36.9

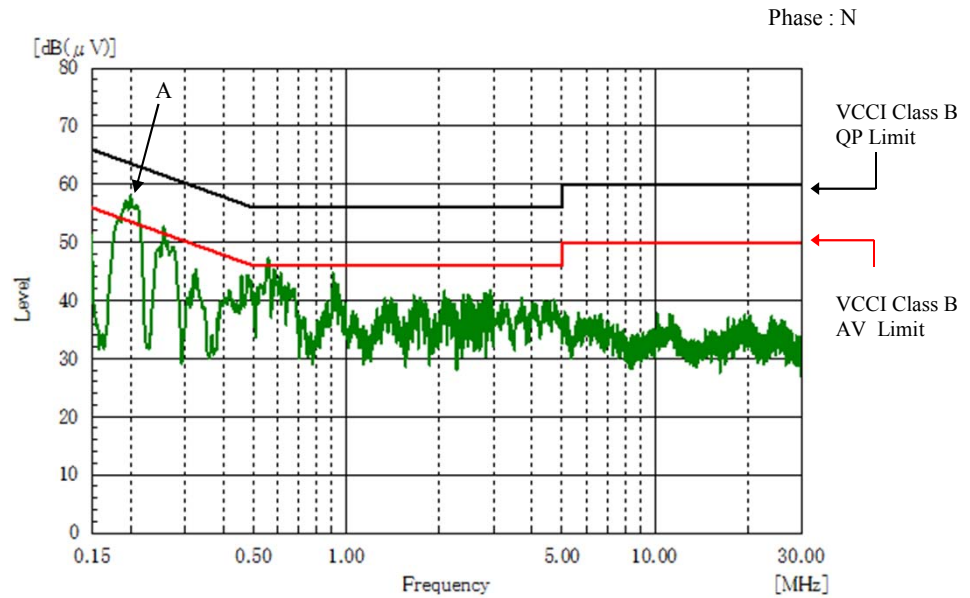

Point B (196kHz)		
Ref. Data	Limit (dB)	Measure (dB)
QP	63.8	54.6
AV	53.8	36.9

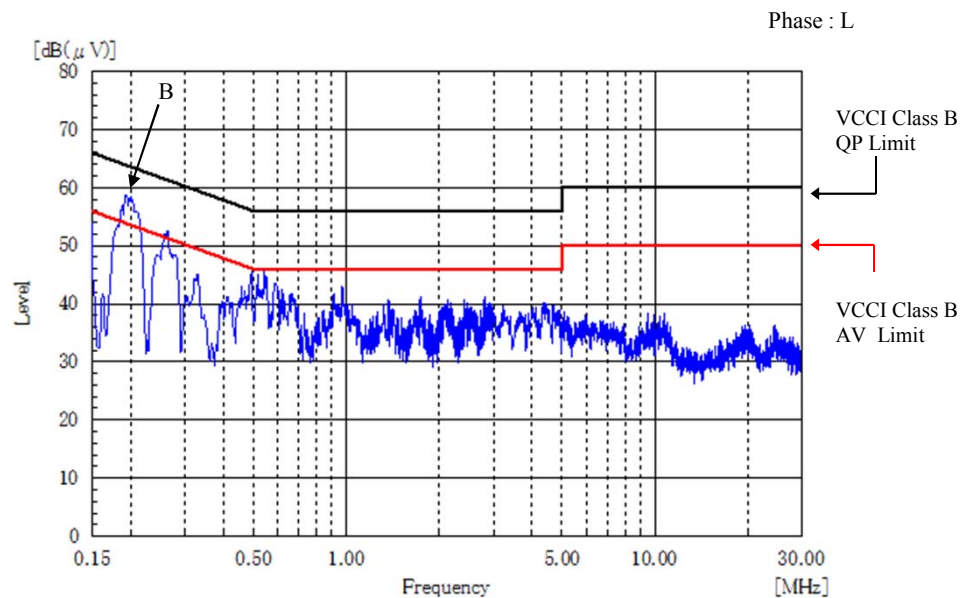

EN55011-B,EN55022-B,FCC-Bの限界値はVCCI class Bの限界値と同じ

Limit of EN55011-B,EN55022-B,FCC-B are same as its VCCI class B.