

PFH500F-28-xxx-R

Evaluation Report

Contents

1. EVALUATION METHOD	3
1.1 Test / Measurement Circuits	3
1.1.1 Steady State Test Measurement Circuit	3
1.1.2 Dynamic, Protection and Output Ripple and Noise Measurement Circuit.....	3
1.1.3 Inrush Current Measurement Circuit.....	4
1.1.4 Leakage Current Measurement Circuit.....	4
1.1.5 Electro-Magnetic Interference Test Set-Up	4
1.1.5.1 Conducted EMI.....	4
1.1.5.2 Radiated EMI	5
2. CHARACTERISTIC	7
2.1 Steady State Data (Refer to Section 1.1.1 For Test Setup)	7
2.1.1 Regulation – Line, Load and Temperature.....	7
2.1.2 Efficiency vs. Output Current	8
2.1.3 Input Current vs. Input Voltage.....	9
2.1.4 Input Current vs. Input Voltage (No Load).....	10
2.1.5 Power Factor (PF) vs. Output Current.....	11
2.1.6 Output behavior with input line sweep	11
2.2 Over Current Protection (OCP) Characteristics (Refer to section 1.1.2 for Test Setup)	13
2.3 Over Voltage Protection (OVP) Characteristics (Refer to Section 1.1.2 for Test Setup)	14
2.4 Output Rise and Fall Characteristic with AC Turn On / Turn-Off	15
2.5 Hold Up Time Characteristic	17
2.6 Dynamic Line Response	17
2.7 Dynamic Load Response	18
2.8 Brownout	19
2.9 Inrush Current (Refer to Section 1.1.3 for Test Setup)	21
2.10 Input Current Waveform	22
2.11 Input Current Harmonics	22
2.12 Output Ripple and Noise	23
2.13 Electro-Magnetic Interference Characteristics	24
2.14 Leakage Current (Refer to Section 1.1.4 for Test Setup)	34
3. TERMINOLOGIES.....	34

1. EVALUATION METHOD

1.1 Test / Measurement Circuits

1.1.1 Steady State Test Measurement Circuit

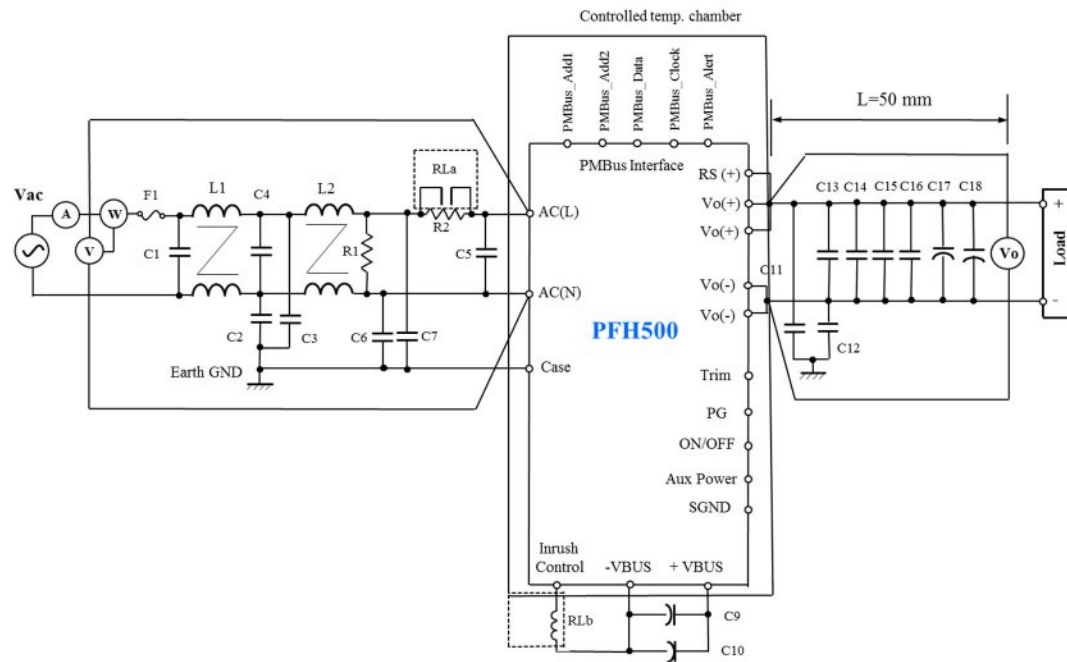

1.1.2 Dynamic, Protection and Output Ripple and Noise Measurement Circuit

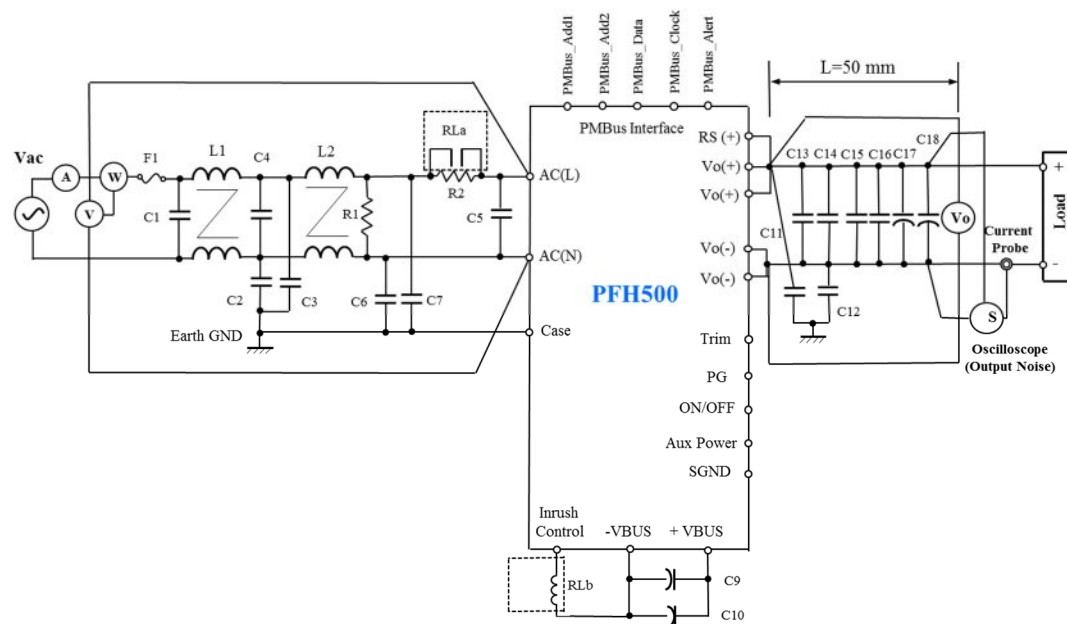

1.1.3 Inrush Current Measurement Circuit

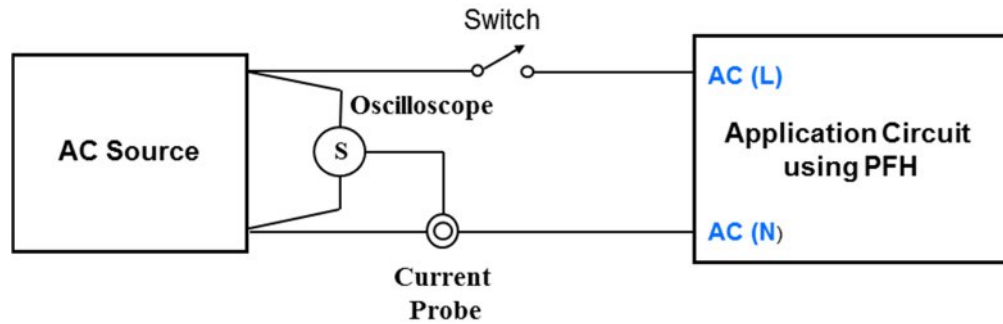

1.1.4 Leakage Current Measurement Circuit

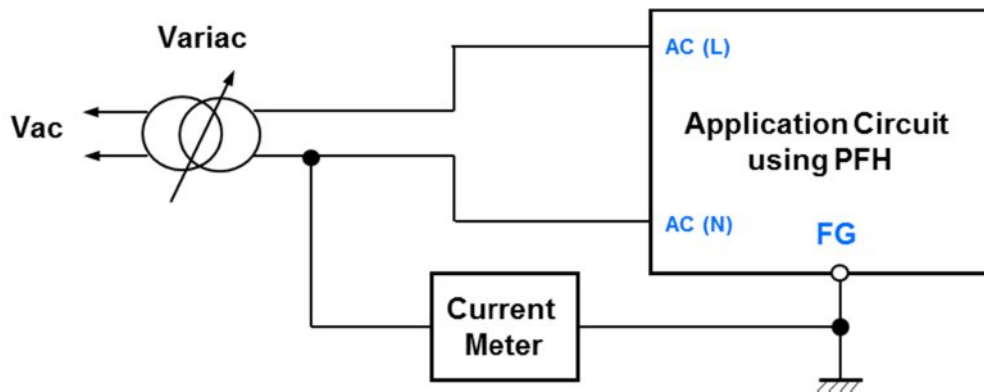

1.1.5 Electro-Magnetic Interference Test Set-Up

1.1.5.1 Conducted EMI

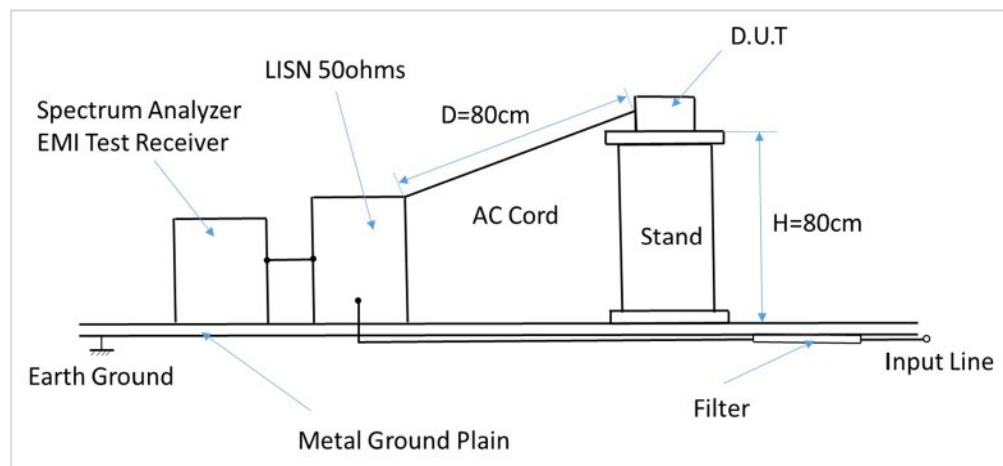

1.1.5.2 Radiated EMI

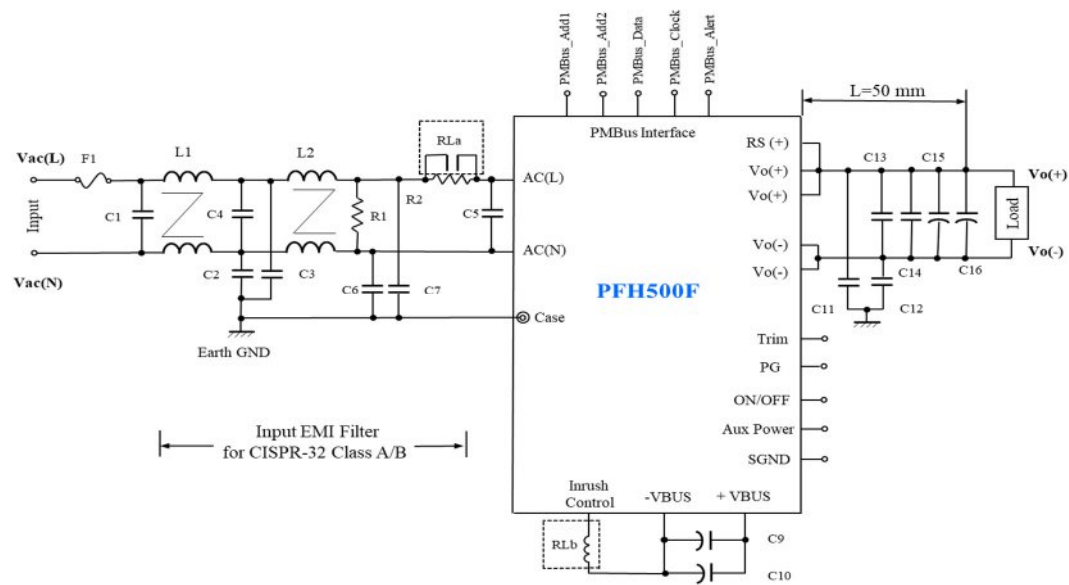
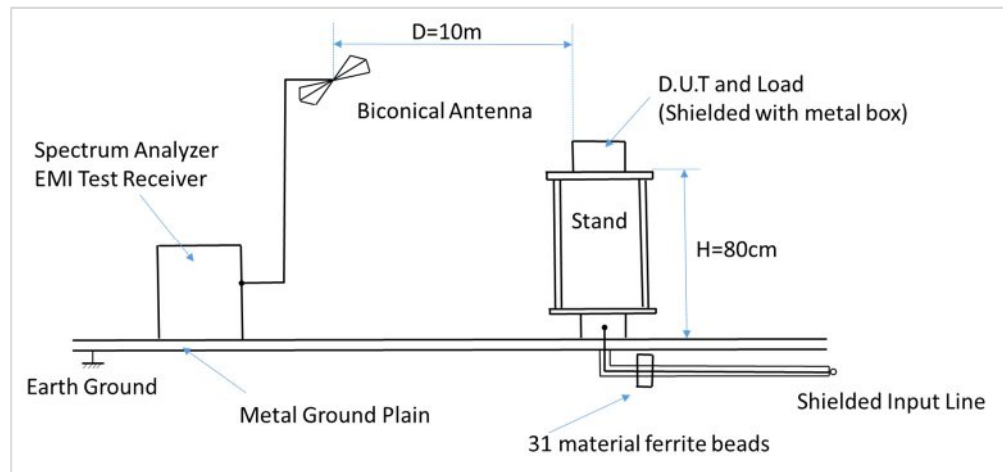

Circuit Code	Description	Circuit Code	Description
C1, C4	1 μ F Film Capacitor	C5	2.2 μ F Film Capacitor
C2, C3	3300pF Ceramic Capacitor	C6, C7	470pF Ceramic Capacitor
L1, L2	6.3mH	R2	22 Ohms
R1	470kOhms	C13	0.1 μ F Ceramic Capacitor
C15, C16 ⁽¹⁾	470 μ F Electrolytic Capacitor	C14	40uF Ceramic Capacitor
C11, C12	470pF Ceramic Capacitor	C9, C10	470 μ F Electrolytic Capacitor
RLa,RLb	1 Form A relay with 10A, 277VAC, power rating: 12VDC, 16.7mA, 200mW, High Sensitivity	F1	10A, 250V, Fast Blow

(1): Higher Capacitance Value (~2X total cap value recommended) for $T_a \leq -20$ °C operation.

List of Equipment

	EQUIPMENT USED	MANUFACTURER	MODEL NO.
1	OSCILLOSCOPE	LECROY	WaveSurfer 454
2	OSCILLOSCOPE	LECROY	WaveRunner 6050
3	DIGITAL MULTIMETER	KEITHLEY	2110
4	DIGITAL MULTIMETER	KEITHLEY	2110
5	DIFFERENTIAL AMPLIFIER	LECROY	DA1855A
6	DIFFERENTIAL AMPLIFIER	LECROY	DA1855A
7	SHUNT RESISTER	EMPRO SHUNT	HA20-100
8	TEMP CHAMBER	TENNEY JUNIOR ENVIRONMENTAL	TJR
9	DIFFERENTIAL PROBE	LECROY	A101
10	DIFFERENTIAL PROBE	LECROY	DXG100A
11	DIGITAL POWER METER	YOKOGAWA	WT310
12	SURGE TESTER	THERMO SCIENTIFIC	EMCPRO PLUS
13	DC ELECTRONIC LOAD	CHROMA	63201
14	FREQUENCY ANALYZER	AP INSTRUMENT	300
15	AC POWER SOURCE	CHROMA	6530
16	INJECTION ISOLATOR	RIDLEY ENGINEERING	0.1Hz TO 30MHz
17	WAVEFORM GENERATOR	AGILENT	33120A
18	DC ELECTRONIC LOAD	CHROMA	6334
19	AC CONTROL	SORENSEN	DCS150-20
20	THERMOSTREAM	TEMPTRONIC CORPORATION	ATS-810-M-4
21	CURRENT PROBE	LECROY	AP015
22	CURRENT PROBE	LECROY	CP150

2. CHARACTERISTIC

2.1 Steady State Data (Refer to Section 1.1.1 For Test Setup)

2.1.1 Regulation – Line, Load and Temperature

a. Low Line Regulation - Line and Load

Conditions: $T_a = 25\text{ }^\circ\text{C}$

$I_o \setminus V_{IN}$	85VAC	100VAC	115VAC	130VAC	Line Regulation	
0%	28.099V	28.062V	28.071V	28.071V	0.037V	0.132%
50%	28.096V	28.059V	28.061V	28.061V	0.037V	0.132%
100%	28.075V	28.056V	28.046V	28.052V	0.029V	0.104%
Load Regulation	0.024V	0.005V	0.024V	0.019V		
	0.086%	0.018%	0.086%	0.068%		

b. Temperature Regulation

Conditions: $V_{IN} = 115\text{ VAC}$

$I_o = 100\%$

T_a	-40 °C	+25 °C	+75 °C	Temperature Stability
V_o	28.186V	28.046V	27.914V	-272mV -0.971%

c. High line Regulation - Line and Load

Conditions: $T_a = 25\text{ }^\circ\text{C}$

$I_o \setminus V_{IN}$	200VAC	220VAC	230VAC	265VAC	Line Regulation	
0%	28.064V	28.065V	28.052V	28.062V	0.014V	0.050%
50%	28.062V	28.062V	28.059V	28.058V	0.005V	0.018%
100%	28.052V	28.051V	28.044V	28.058V	0.014V	0.050%
Load Regulation	0.012V	0.014V	0.014V	0.005V		
	0.043%	0.050%	0.050%	0.018%		

d. Temperature Regulation

Conditions: $V_{IN} = 230\text{ VAC}$

$I_o = 100\%$

T_a	-40 °C	+25 °C	+75 °C	Temperature Stability
V_o	28.217V	28.044V	27.921V	-296mV -1.057%

2.1.2 Efficiency vs. Output Current

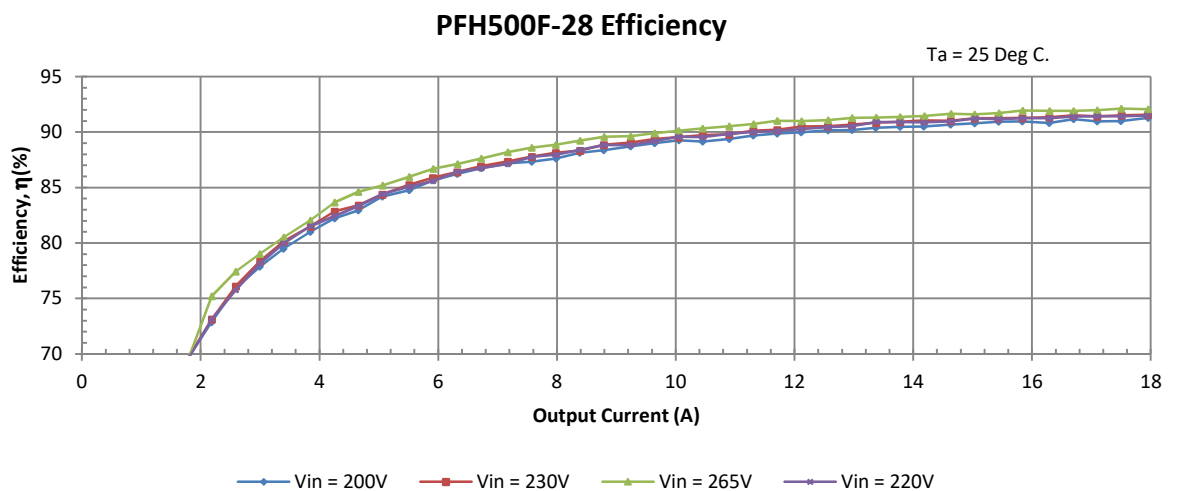
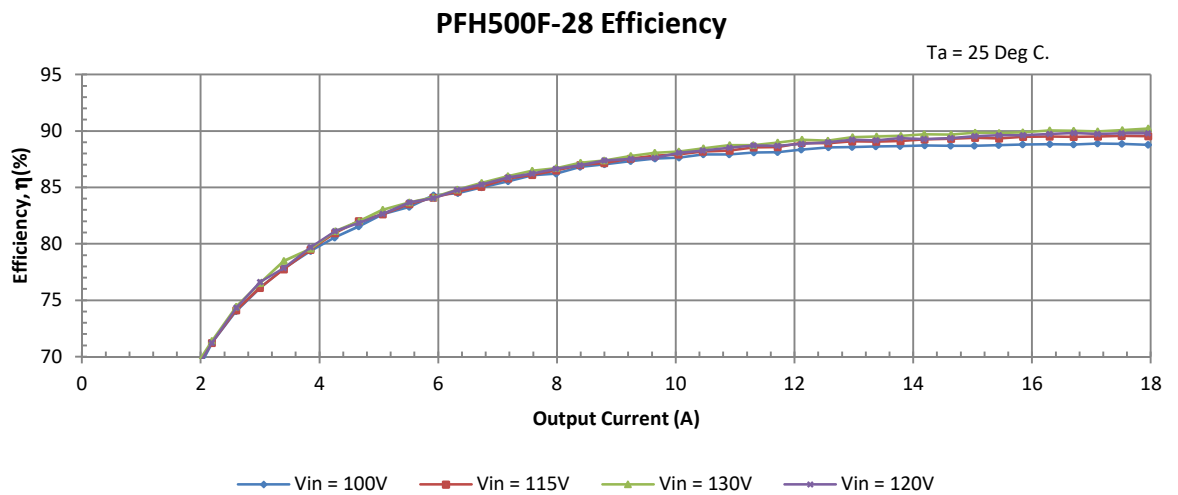
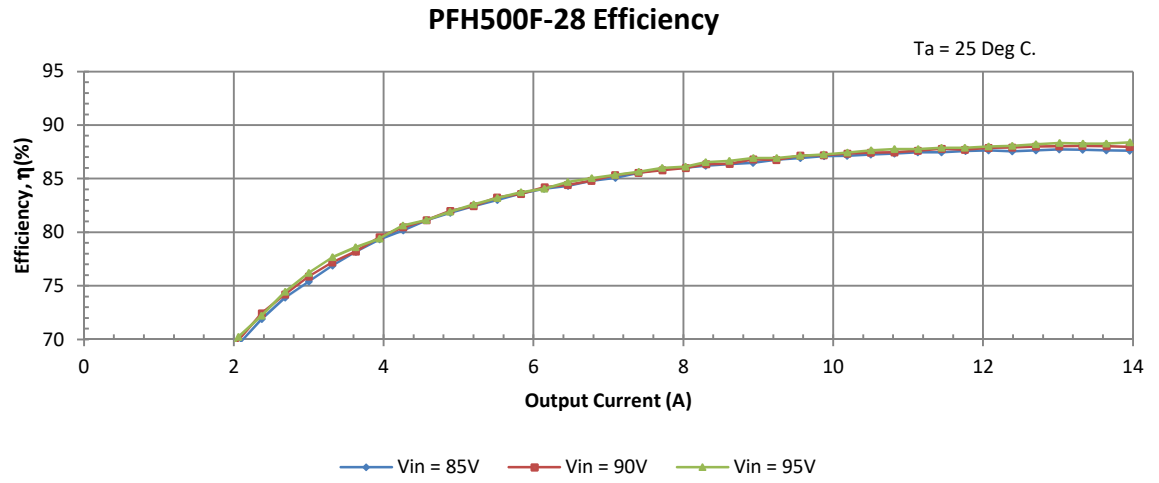

2.1.3 Input Current vs. Input Voltage

Low Line

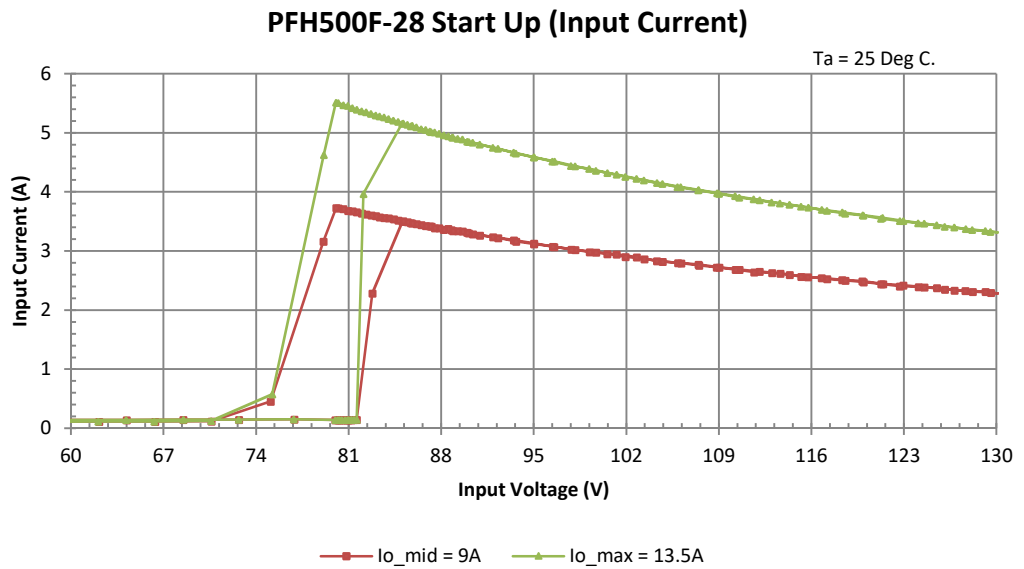

High Line

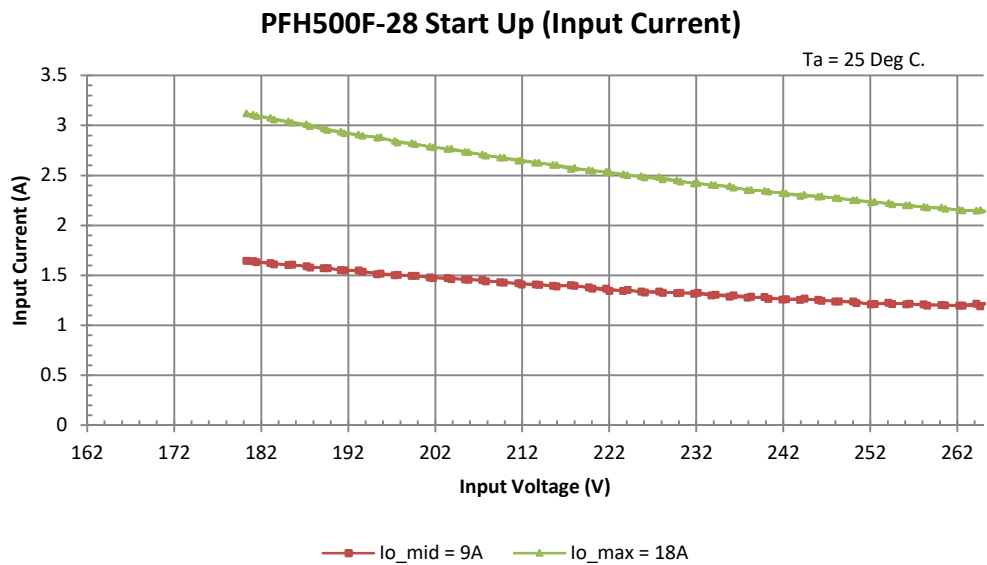

2.1.4 Input Current vs. Input Voltage (No Load)

Low Line

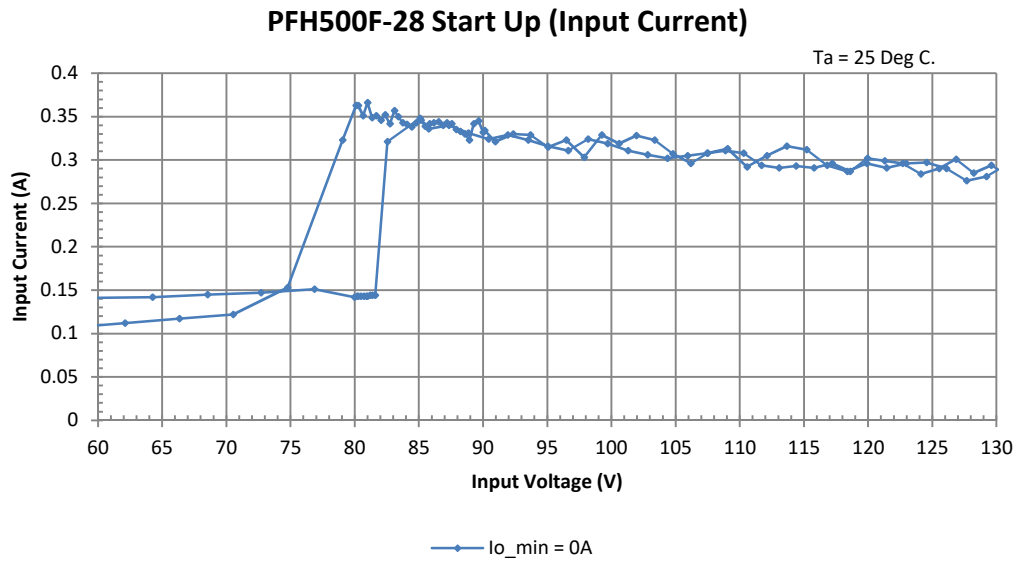

High Line

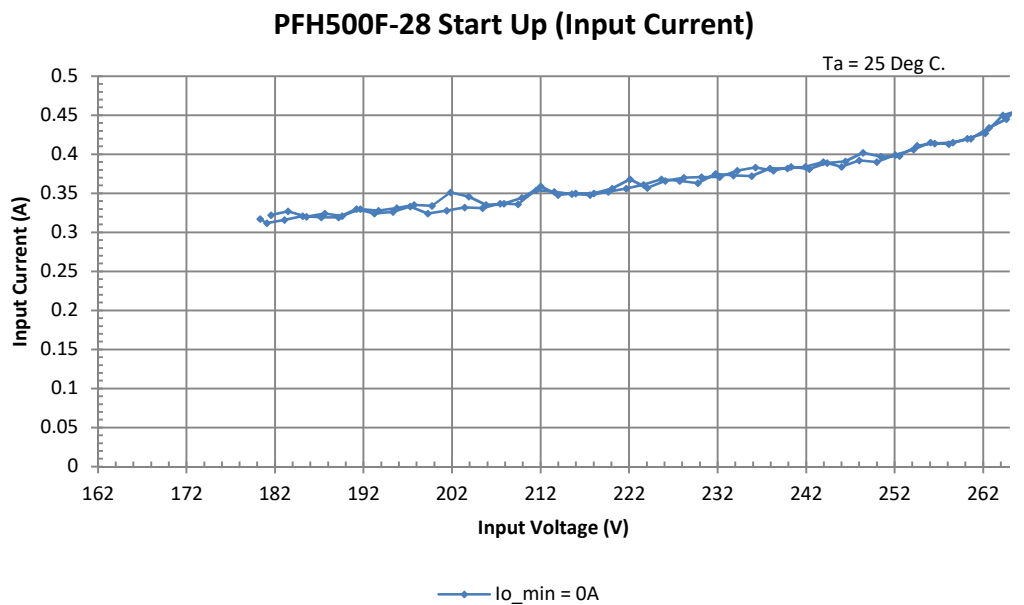

2.1.5 Power Factor (PF) vs. Output Current

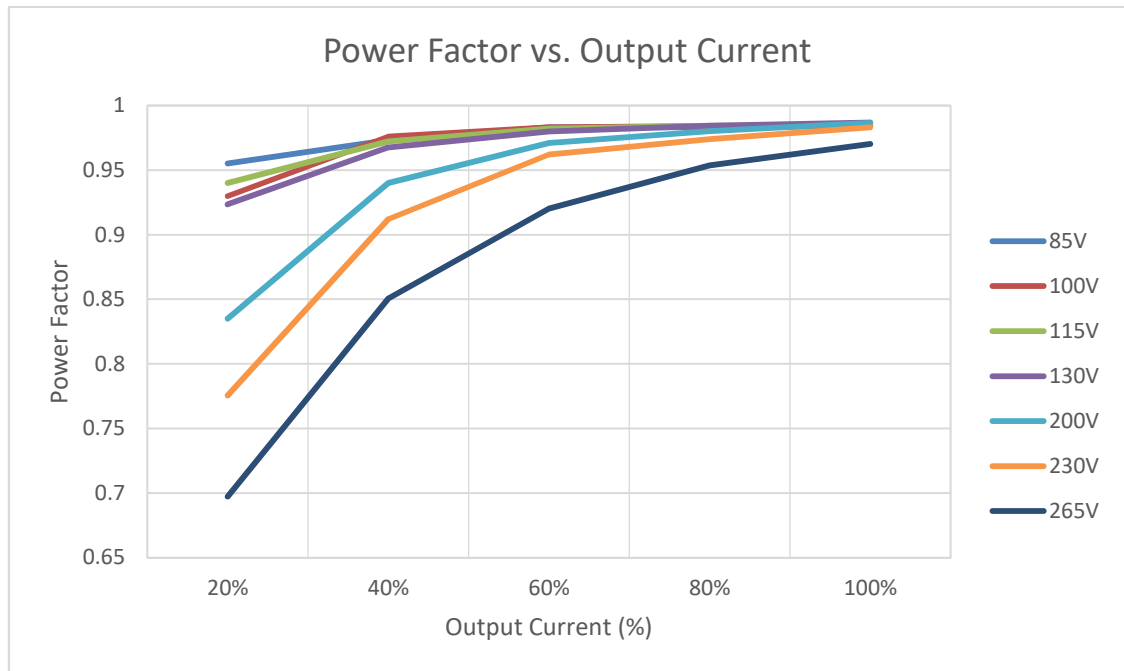

2.1.6 Output behavior with input line sweep

Low Line (Line Sweep from 0 → 135 → 0 VAC)

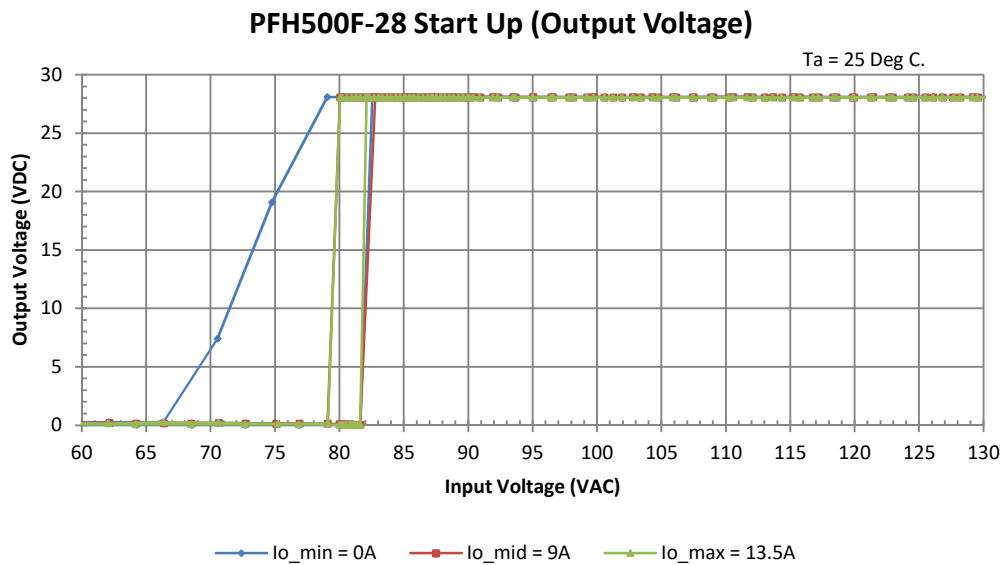

Note: At no load condition, Bulk capacitor will discharge slowly and output voltage will turn off until input voltage drop to 66V.

High Line (Line Sweep from 180 → 265 → 180 VAC)

PFH500F-28 Start Up (Output Voltage)

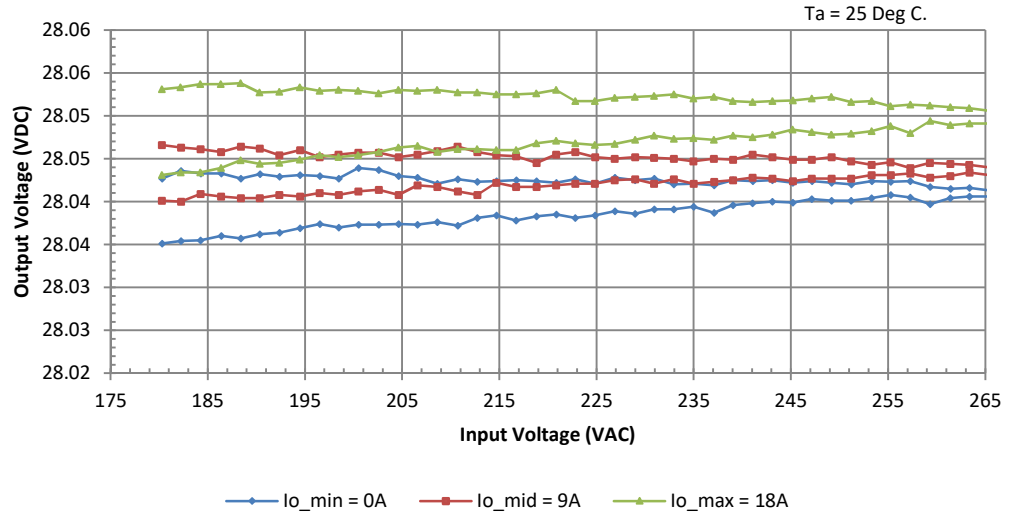

2.2 Over Current Protection (OCP) Characteristics (Refer to section 1.1.2 for Test Setup)

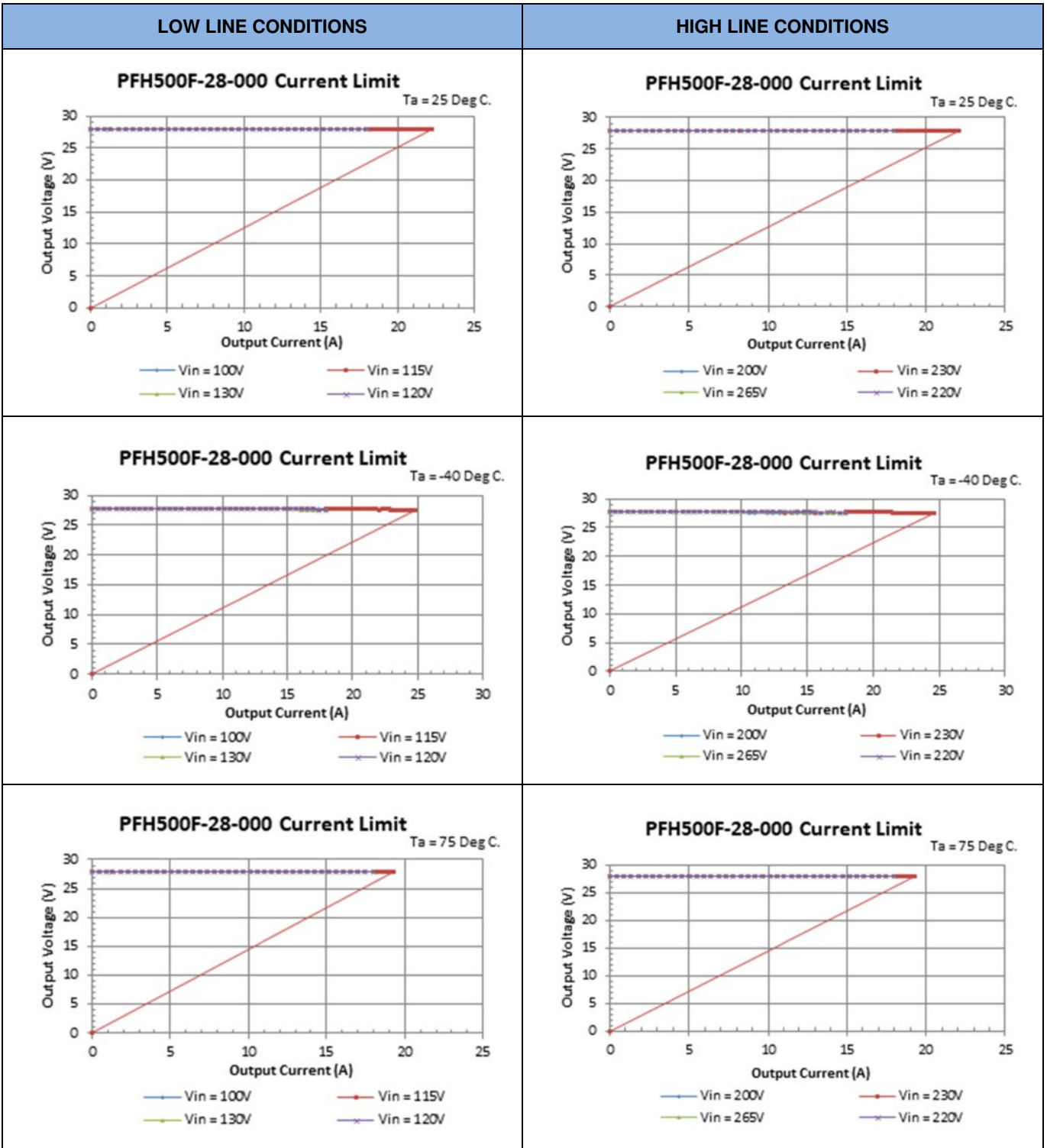

2.3 Over Voltage Protection (OVP) Characteristics (Refer to Section 1.1.2 for Test Setup)

Conditions:	$I_o = 0\%$
	$T_a = 25\text{ }^\circ\text{C}$
	$V_{IN} = 115\text{ VAC}$

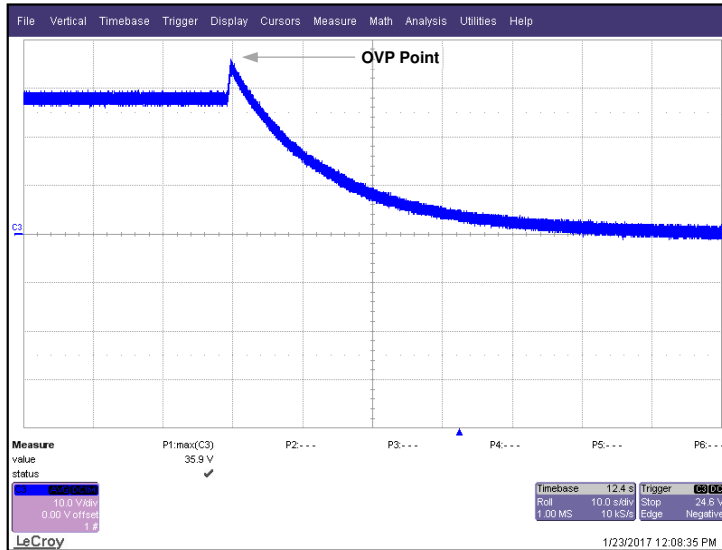

Conditions:	$I_o = 0\%$
	$T_a = 25\text{ }^\circ\text{C}$
	$V_{IN} = 230\text{ VAC}$

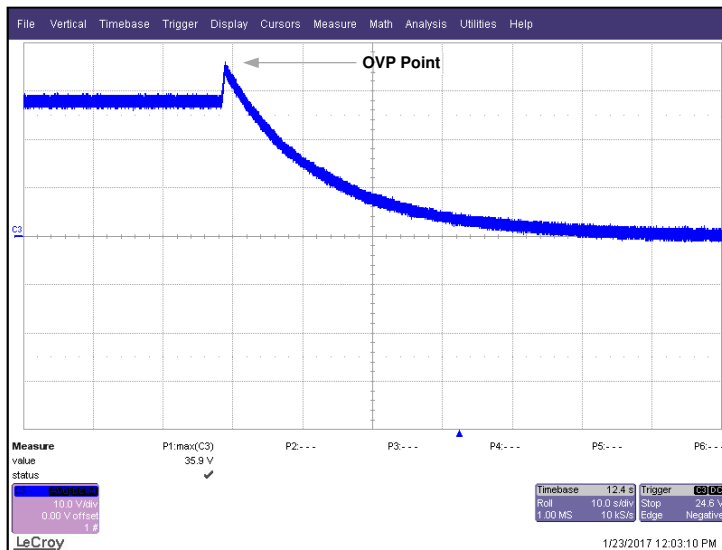

2.4 Output Rise and Fall Characteristic with AC Turn On / Turn-Off

115 VAC No Load Start Up
 CH3: V_O ; CH4: V_{IN}

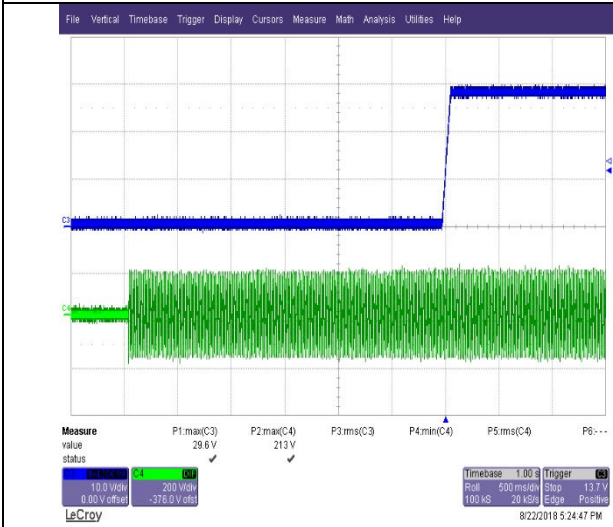

115 VAC No Load Shut Down
 CH3: V_O ; CH4: V_{IN}

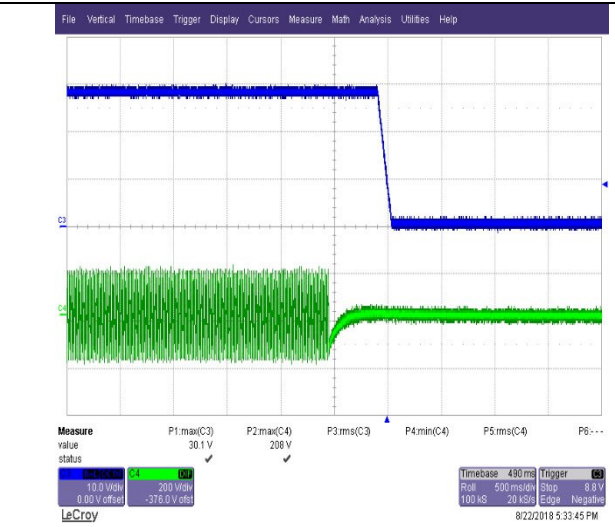

115 VAC Full Load Start Up
 CH3: V_O ; CH4: V_{IN}

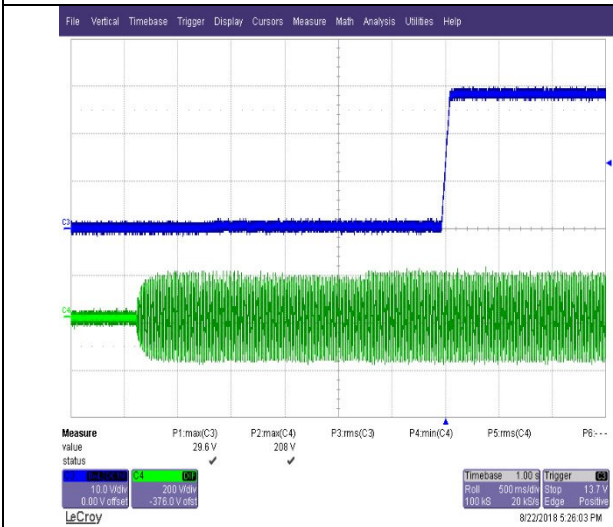

115 VAC Full Load Shut Down
 CH3: V_O ; CH4: V_{IN}

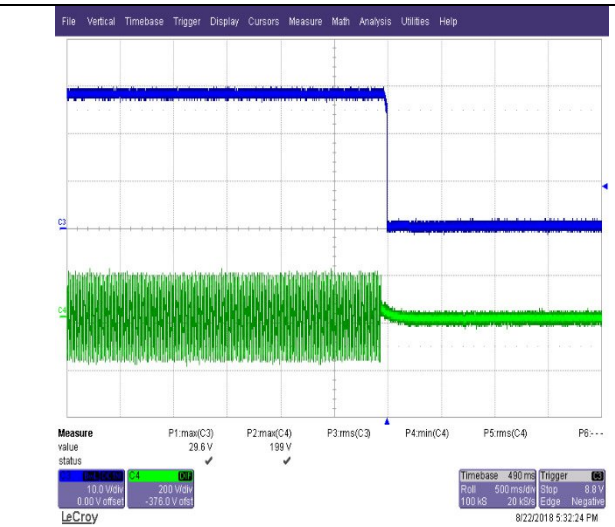

Output Rise and Fall Characteristic (continued)

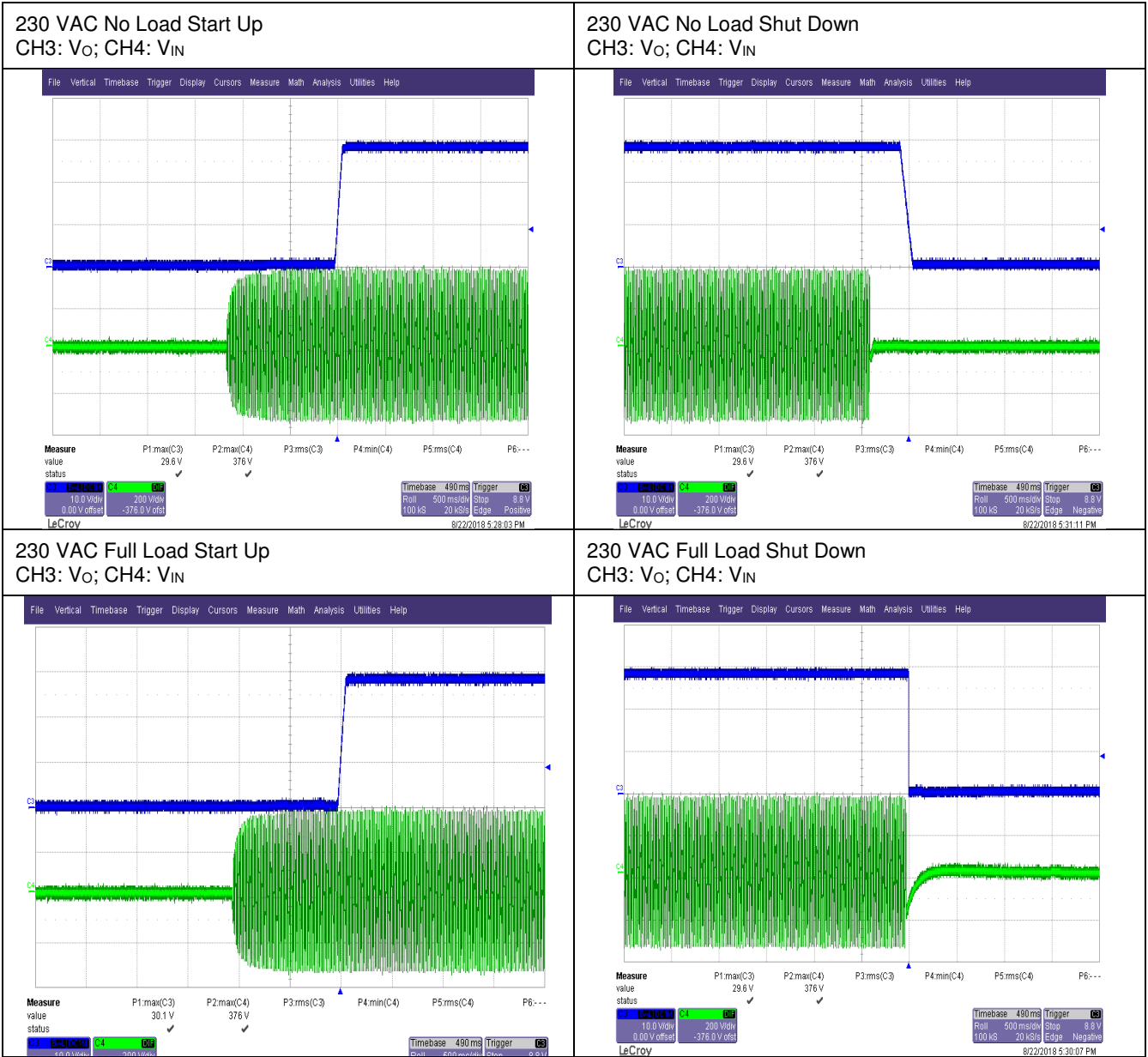

2.5 Hold Up Time Characteristic

$V_{IN} = 115 \text{ VAC}; V_O = 28 \text{ VDC}$

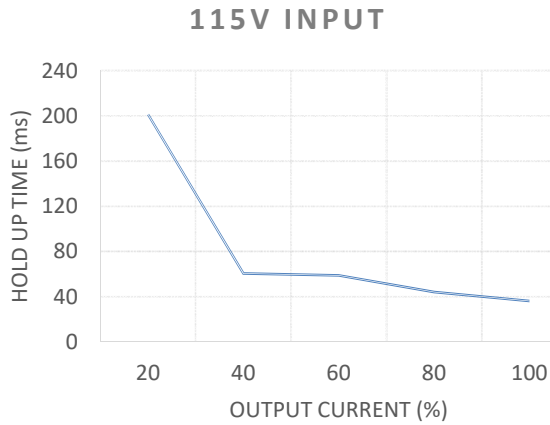

$V_{IN} = 230 \text{ VAC}; V_O = 28 \text{ VDC}$

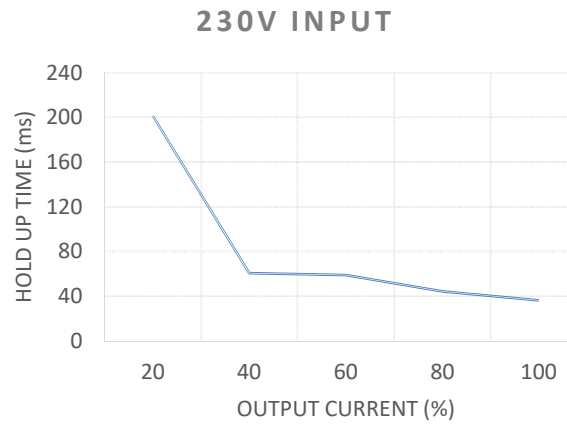

2.6 Dynamic Line Response

$V_{IN} = 90 \leftrightarrow 130 \text{ VAC}; I_O = 15 \text{ A}$
CH1: V_O ; CH3: I_{IN} ; CH4: V_{IN}

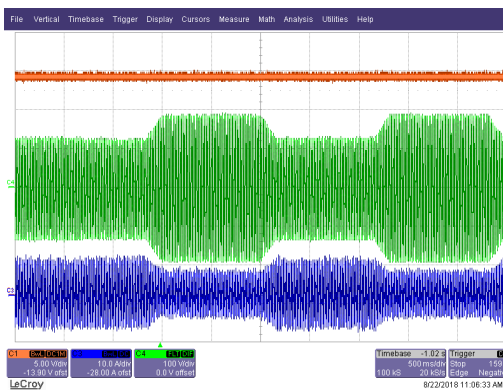

$V_{IN} = 110 \leftrightarrow 260 \text{ VAC}; I_O = 18 \text{ A}$
CH1: V_O ; CH3: I_{IN} ; CH4: V_{IN}

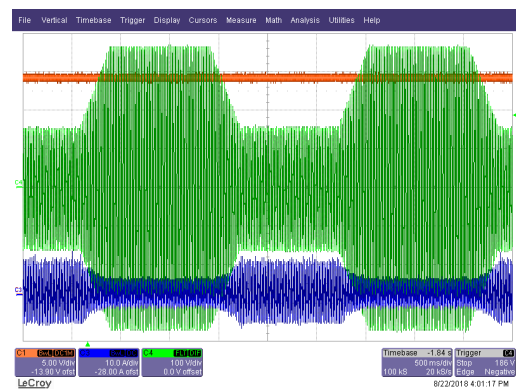

$V_{IN} = 180 \leftrightarrow 265 \text{ VAC}; I_O = 18 \text{ A}$
CH1: V_O ; CH3: I_{IN} ; CH4: V_{IN}

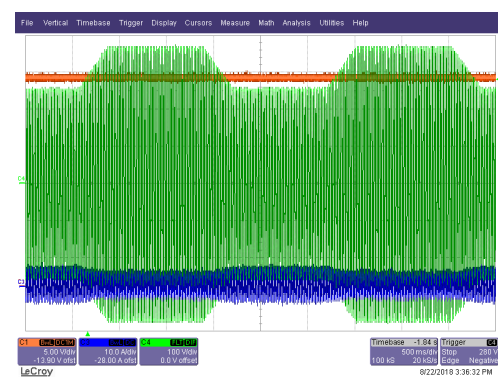

$V_{IN} = 115 \leftrightarrow 250 \text{ VAC}; I_O = 18 \text{ A}$
CH1: V_O ; CH3: I_{IN} ; CH4: V_{IN}

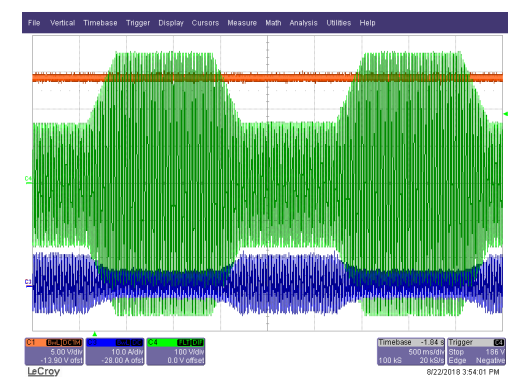

2.7 Dynamic Load Response

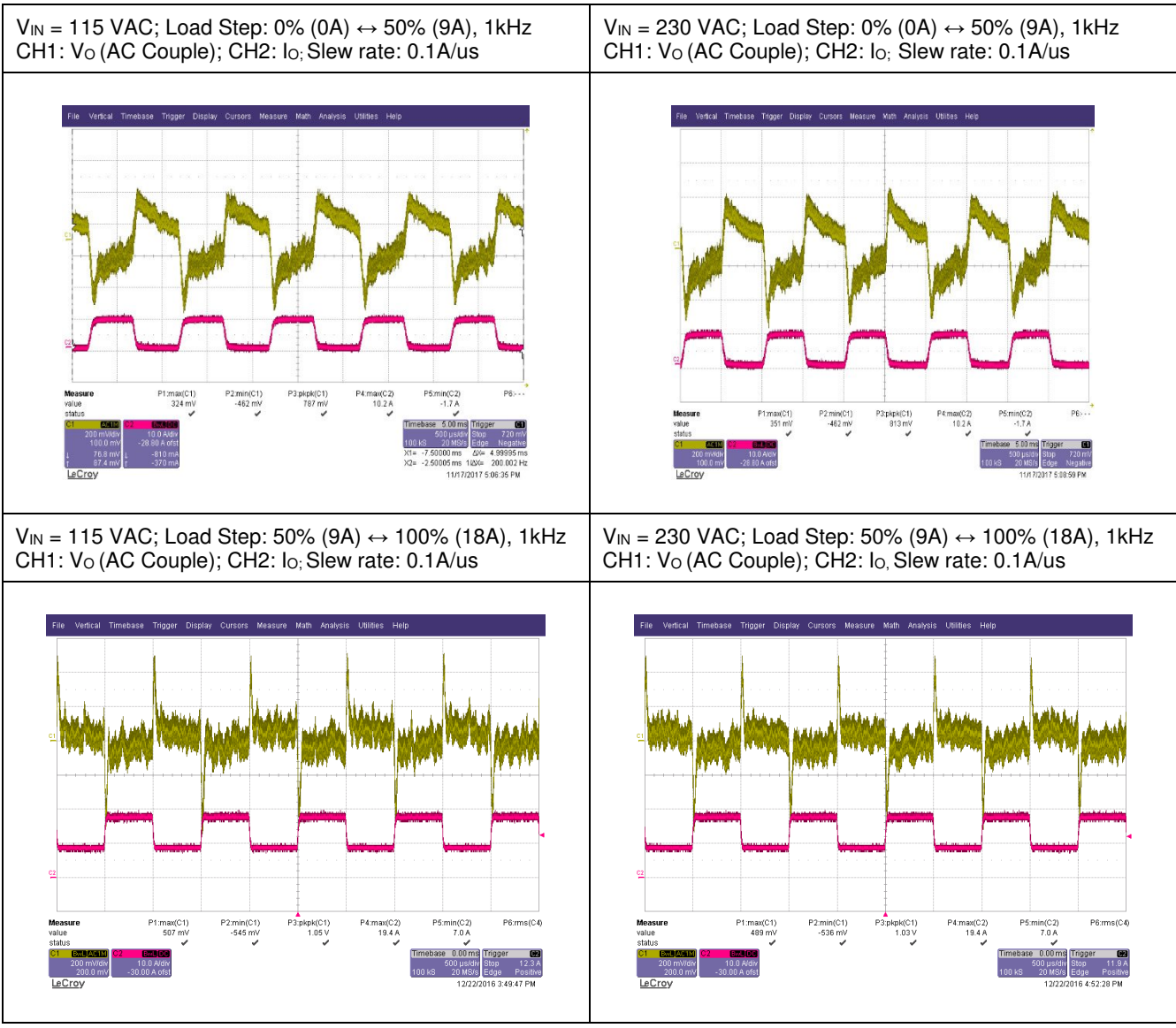

2.8 Brownout

$T_a = 25\text{ }^\circ\text{C}$

$V_{IN} = 115\text{ VAC} / 50\text{ Hz}$; $I_o = 18\text{ A}$; Brownout Time = 1ms
CH1: V_o ; CH3: I_{IN} ; CH4: V_{IN}

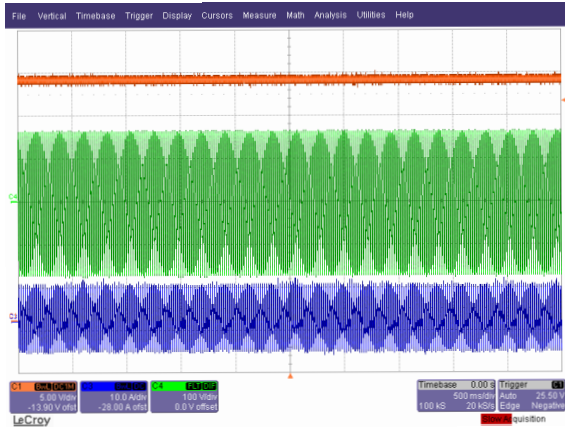

$V_{IN} = 115\text{ VAC} / 50\text{ Hz}$; $I_o = 18\text{ A}$; Brownout Time = 2ms
CH1: V_o ; CH3: I_{IN} ; CH4: V_{IN}

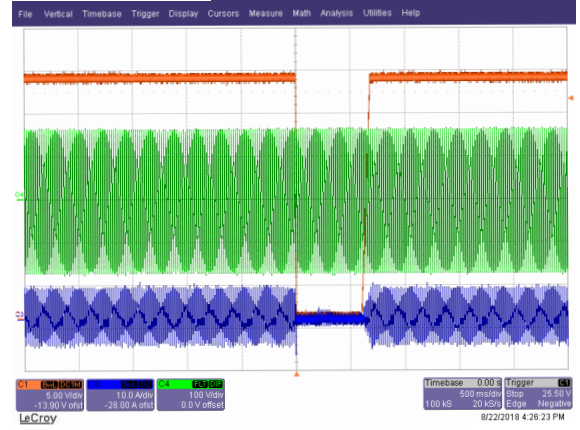

$V_{IN} = 115\text{ VAC} / 60\text{ Hz}$; $I_o = 18\text{ A}$; Brownout Time = 1ms
CH1: V_o ; CH3: I_{IN} ; CH4: V_{IN}

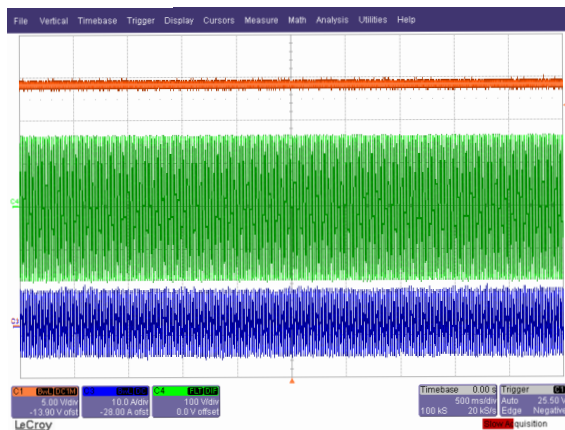

$V_{IN} = 115\text{ VAC} / 60\text{ Hz}$; $I_o = 18\text{ A}$; Brownout Time = 2ms
CH1: V_o ; CH3: I_{IN} ; CH4: V_{IN}

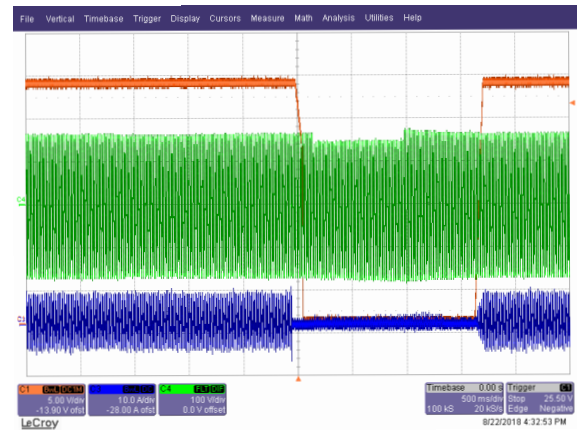

Brownout (continued)

$T_a = 25\text{ }^\circ\text{C}$

$V_{IN} = 230\text{ VAC} / 50\text{ Hz}$; $I_o = 18\text{ A}$; Brownout Time = 1ms
CH1: V_o ; CH3: I_{IN} ; CH4: V_{IN}

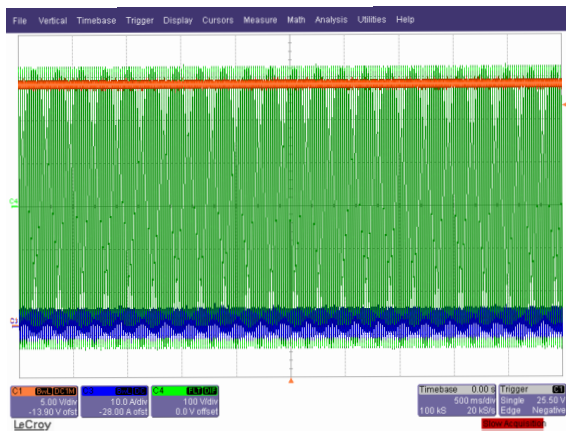

$V_{IN} = 230\text{ VAC} / 50\text{ Hz}$; $I_o = 18\text{ A}$; Brownout Time = 2ms
CH1: V_o ; CH3: I_{IN} ; CH4: V_{IN}

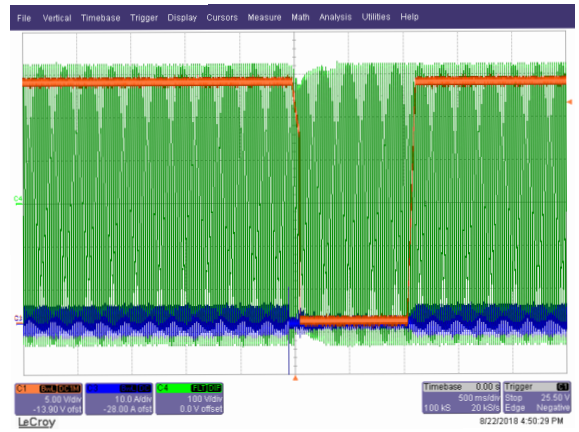

$V_{IN} = 230\text{ VAC} / 60\text{ Hz}$; $I_o = 18\text{ A}$; Brownout Time = 1ms
CH1: V_o ; CH3: I_{IN} ; CH4: V_{IN}

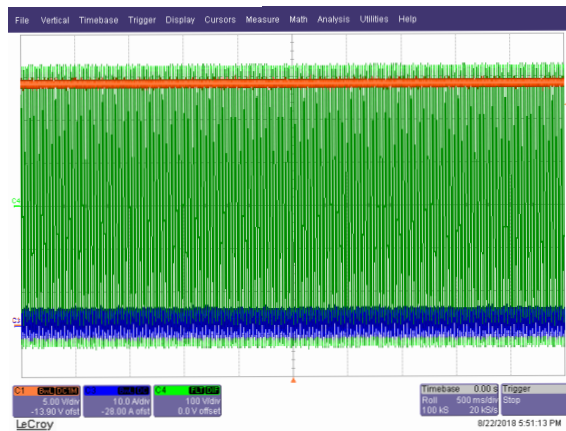

$V_{IN} = 230\text{ VAC} / 60\text{ Hz}$; $I_o = 18\text{ A}$; Brownout Time = 2ms
CH1: V_o ; CH3: I_{IN} ; CH4: V_{IN}

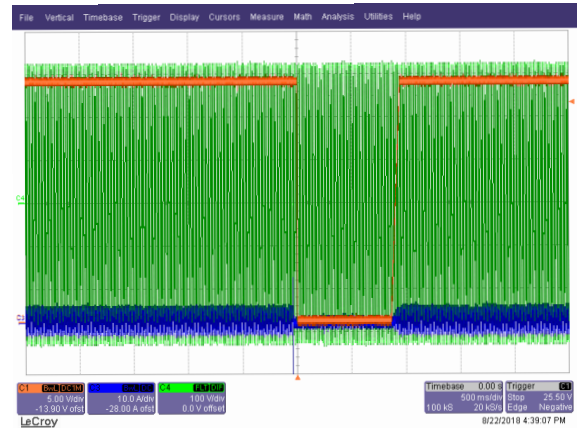

2.9 Inrush Current (Refer to Section 1.1.3 for Test Setup)

Condition:	$I_o = 100\%$
	$T_a = 25\text{ }^\circ\text{C}$

$V_{IN} = 115\text{ VAC}; \phi = 0^\circ$ (Switch On Phase Angle)
CH1: V_O ; CH2: V_{IN} ; CH3: I_{IN}

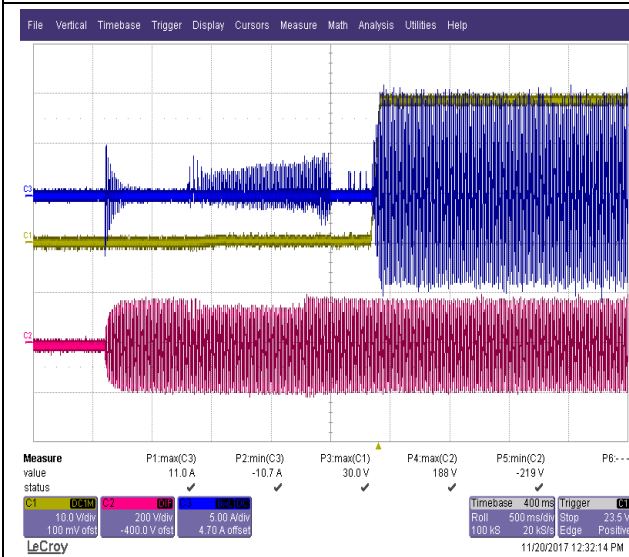

$V_{IN} = 115\text{ VAC}; \phi = 90^\circ$ (Switch On Phase Angle)
CH1: V_O ; CH2: V_{IN} ; CH3: I_{IN}

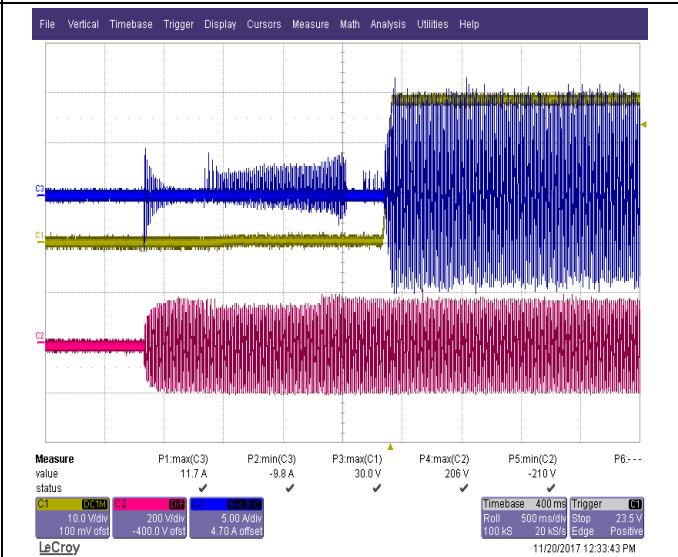

$V_{IN} = 230\text{ VAC}; \phi = 0^\circ$ (Switch On Phase Angle)
CH1: V_O ; CH2: V_{IN} ; CH3: I_{IN}

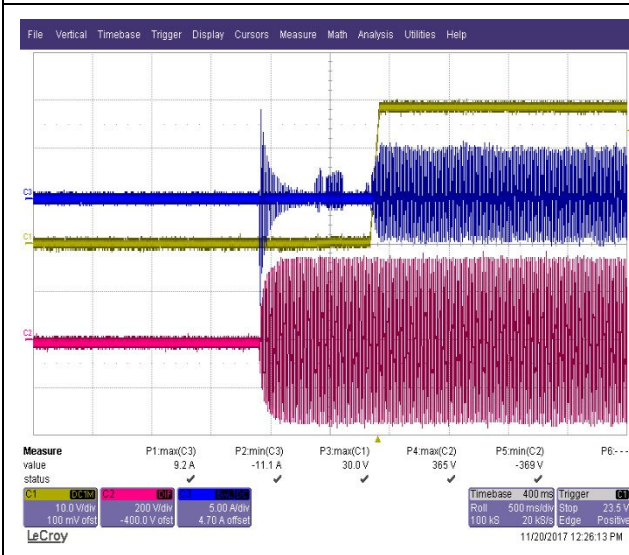

$V_{IN} = 230\text{ VAC}; \phi = 90^\circ$ (Switch On Phase Angle)
CH1: V_O ; CH2: V_{IN} ; CH3: I_{IN}

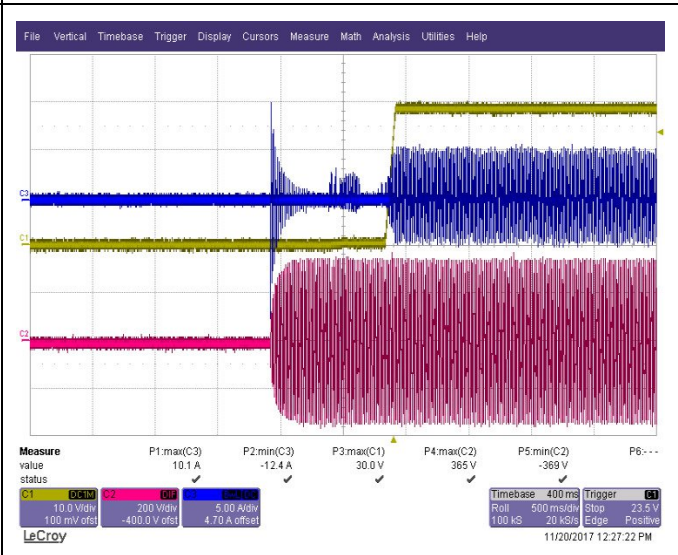

2.10 Input Current Waveform

Condition:	$I_o = 100\%$
	$T_a = 25\text{ }^\circ\text{C}$

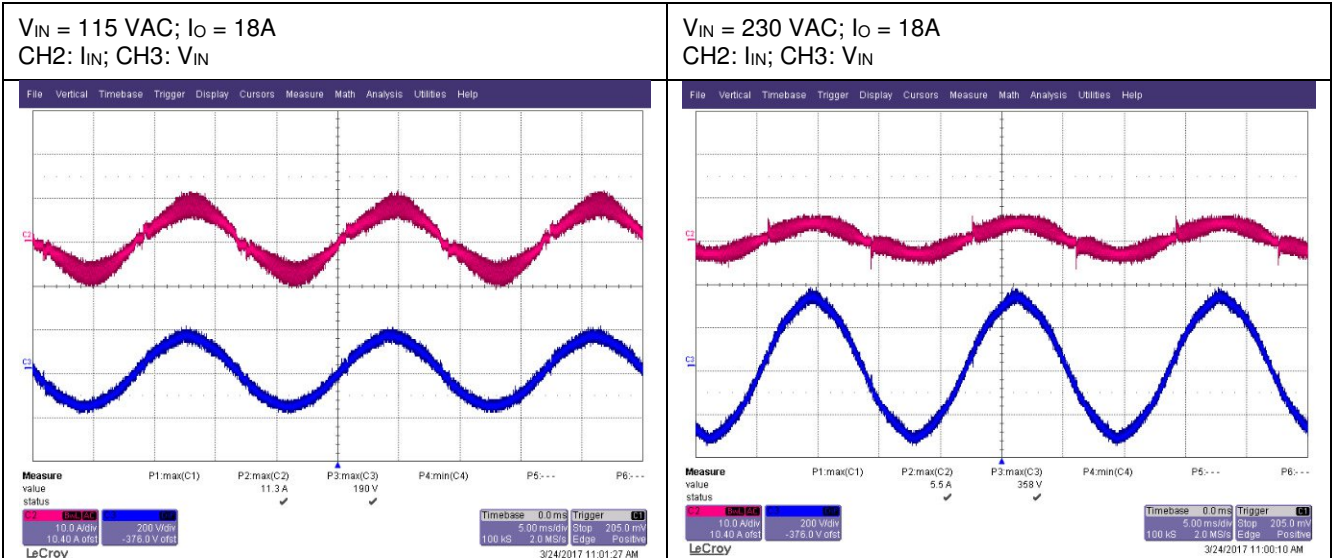

2.11 Input Current Harmonics

Condition:	$I_o = 100\%$
	$T_a = 25\text{ }^\circ\text{C}$

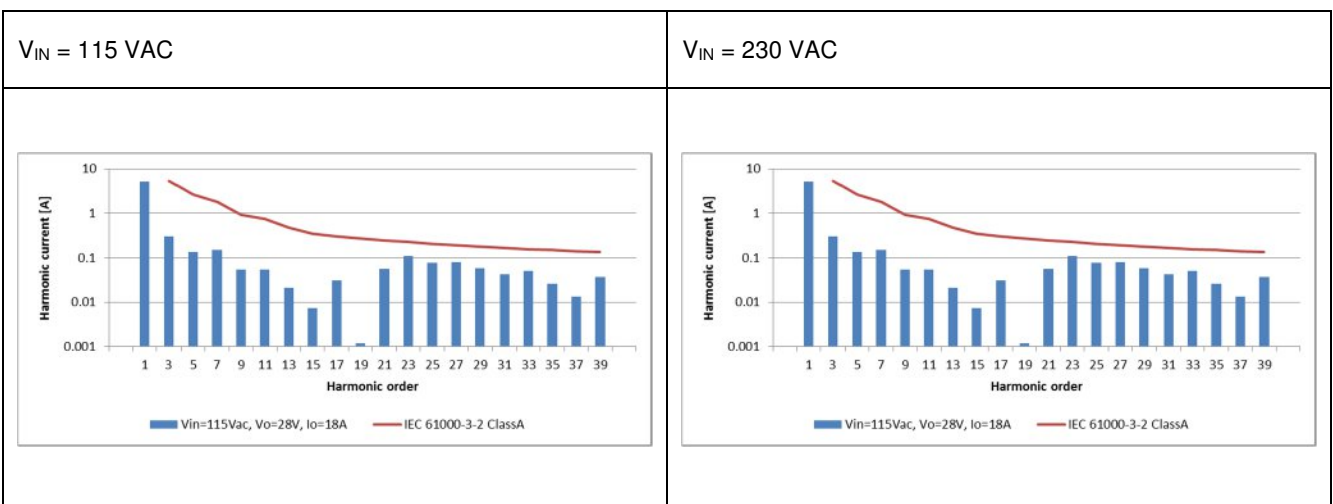

2.12 Output Ripple and Noise

$T_a = 25\text{ }^\circ\text{C}$

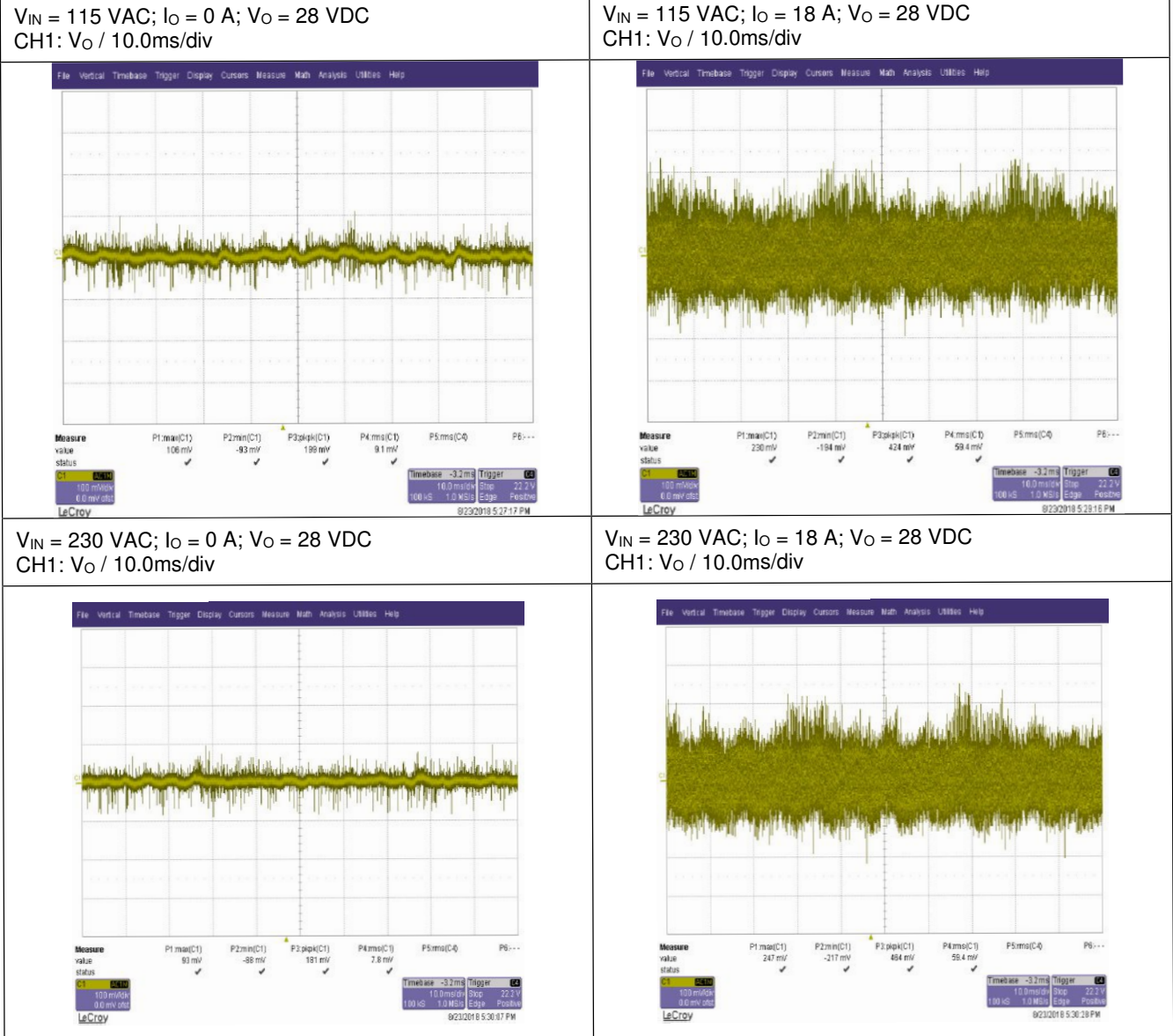

2.13 Electro-Magnetic Interference Characteristics

Conducted EMI:

Certified Laboratory	Element Materials Technology Group Limited
Test Location	Plano, TX
Test Board	Test performed with the PFH500 module mounted on PFH05W- 001-EVK-S0 Evaluation test Board (Rev 02)

Test Setup

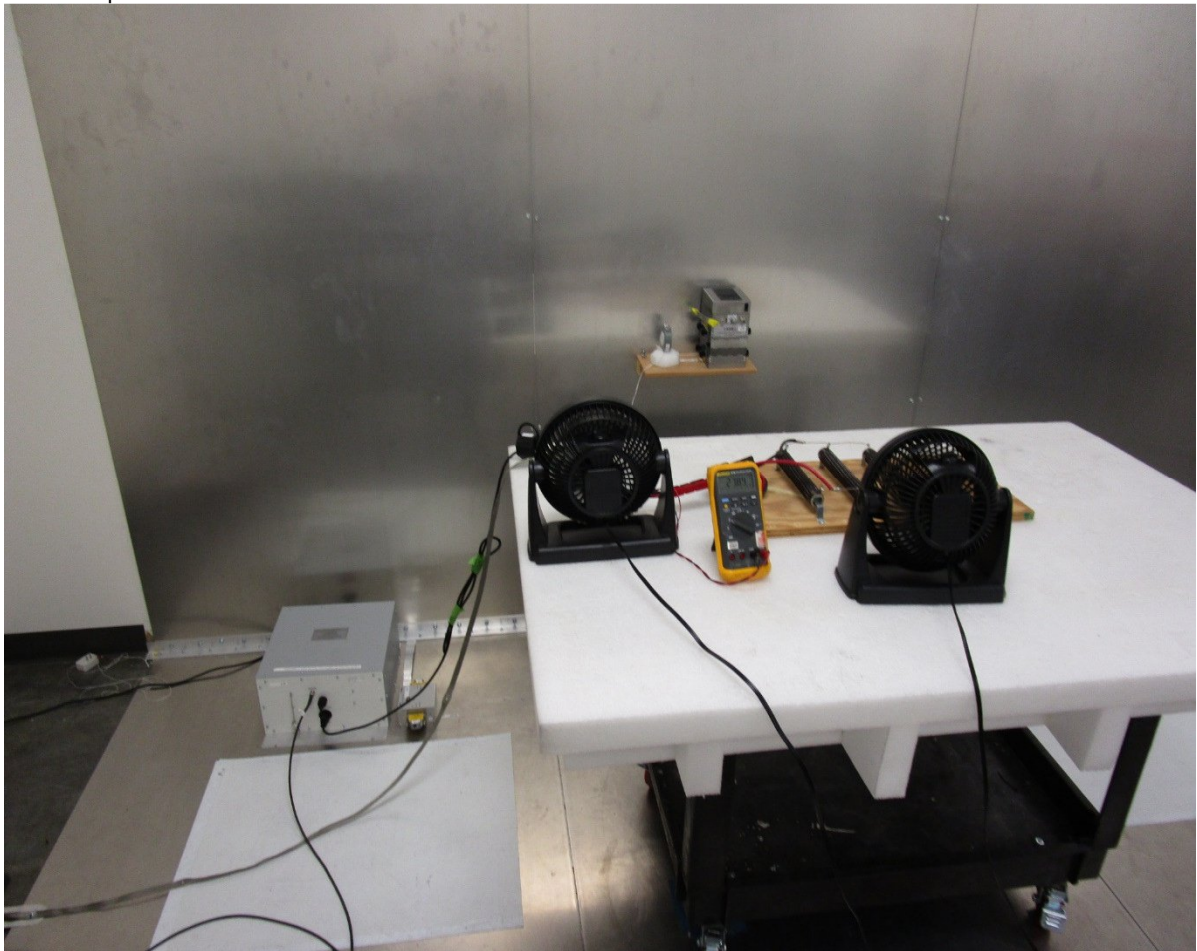

110V High line



CONDUCTED EMISSIONS

Work Order:	TDKL0022	Date:	1-May-2019	<small>EmRS 2018.08.26</small>	<small>PSA-ESCI 2018.02.26</small>
Project:	None	Temperature:	22.1 °C		
Job Site:	TX01	Humidity:	53.4% RH		
Serial Number:	None	Barometric Pres.:	1017 mbar	Tested by: Marty Martin	
EUT:	PFH 500F-28V-100-R Module				
Configuration:	Unknown				
Customer:	TDK-Lambda Americas Inc.				
Attendees:	Shuhui and Michael				
EUT Power:	110VAC/60Hz				
Operating Mode:	16,9 amp Load				
Deviations:	None				
Comments:	Heatsink tied to EGND				
Test Specifications	Class B		Test Method		
EN 55032:2012/AC:2013		CISPR 32:2015			
Run #	20	Line:	High Line	Ext. Attenuation:	0
Results				Pass	

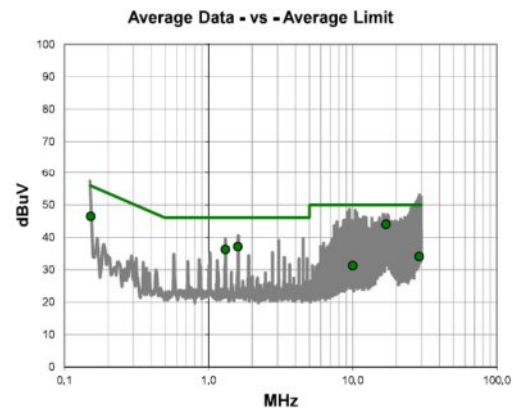
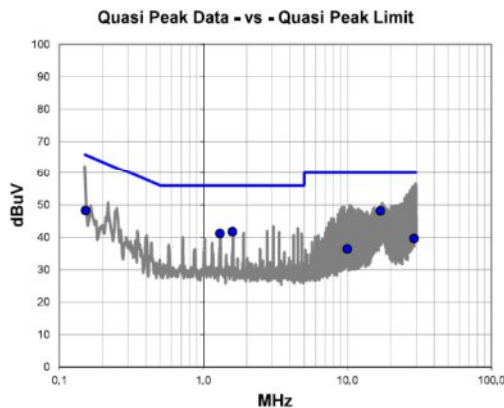

Quasi Peak Data - vs - Quasi Peak Limit

Freq (MHz)	Amplitude (dBuV)	Factor (dB)	Adjusted ()	Spec. Limit ()	Compared to Spec. (dB)
16,994	27,2	20,9	48,1	60,0	-11,9
0,153	27,9	20,3	48,2	65,9	-17,7
1,595	21,6	20,1	41,7	56,0	-14,3
1,306	21,0	20,1	41,1	56,0	-14,9
28,997	17,7	21,9	39,6	60,0	-20,4
9,997	15,9	20,5	36,4	60,0	-23,6

Average Data - vs - Average Limit

Freq (MHz)	Amplitude (dBuV)	Factor (dB)	Adjusted ()	Spec. Limit ()	Compared to Spec. (dB)
16,994	23,1	20,9	44,0	50,0	-6,0
0,153	26,1	20,3	46,4	55,9	-9,5
1,595	17,0	20,1	37,1	46,0	-8,9
1,306	16,1	20,1	36,2	46,0	-9,8
28,997	12,1	21,9	34,0	50,0	-16,0
9,997	10,7	20,5	31,2	50,0	-18,8

110V Neutral

CONDUCTED EMISSIONS



EmiRS 2016.08.26 PBA-ESCI 2019.02.26

Work Order:	TDKL0022	Date:	1-May-2019
Project:	None	Temperature:	22.1 °C
Job Site:	TX01	Humidity:	53.4% RH
Serial Number:	None	Barometric Pres.:	1017 mbar
EUT: PFH 500F-28V-100-R Module			Tested by: Marty Martin
Configuration:	Unknown		
Customer:	TDK-Lambda Americas Inc.		
Attendees:	Shuhui and Michael		
EUT Power:	110VAC/60Hz		
Operating Mode:	16.9 amp Load		
Deviations:	None		
Comments:	Heatsink tied to EGND		

Test Specifications	Class B	Test Method
EN 55032:2012/AC:2013		CISPR 32:2015

Run #	21	Line:	Neutral	Ext. Attenuation:	0	Results	Pass
--------------	----	--------------	---------	--------------------------	---	----------------	------

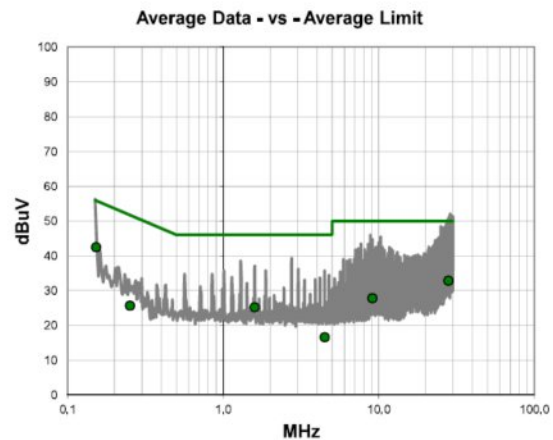
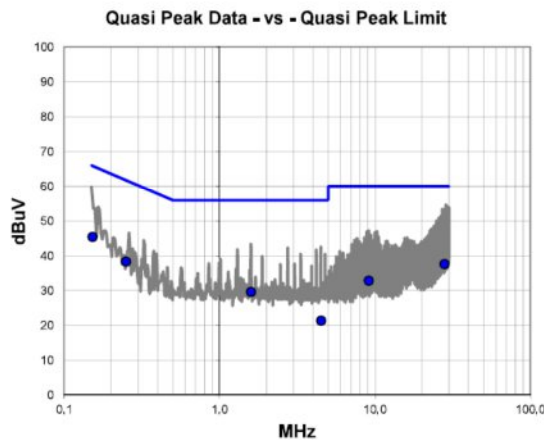

Quasi Peak Data - vs - Quasi Peak Limit

Freq (MHz)	Amplitude (dBuV)	Factor (dB)	Adjusted (dBuV)	Spec. Limit (dBuV)	Compared to Spec. (dB)
0,153	25,1	20,3	45,4	65,9	-20,5
27,991	15,8	21,8	37,6	60,0	-22,4
9,091	12,4	20,5	32,9	60,0	-27,1
0,251	18,1	20,2	38,3	61,7	-23,4
1,590	9,5	20,1	29,6	56,0	-26,4
4,495	1,2	20,2	21,4	56,0	-34,6

Average Data - vs - Average Limit

Freq (MHz)	Amplitude (dBuV)	Factor (dB)	Adjusted (dBuV)	Spec. Limit (dBuV)	Compared to Spec. (dB)
0,153	22,2	20,3	42,5	55,9	-13,4
27,991	11,1	21,8	32,9	50,0	-17,1
9,091	7,3	20,5	27,8	50,0	-22,2
1,590	5,1	20,1	25,2	46,0	-20,8
0,251	5,5	20,2	25,7	51,7	-26,0
4,495	-3,6	20,2	16,6	46,0	-29,4

230V Line



CONDUCTED EMISSIONS

EmiRS 2018.09.26 PSA-ESCI 2019.02.26

Work Order:	TDKL0022	Date:	1-May-2019	
Project:	None	Temperature:	22,1 °C	
Job Site:	TX01	Humidity:	53.4% RH	
Serial Number:	None	Barometric Pres.:	1017 mbar	Tested by: Marty Martin
EUT:	PFH 500F-28V-100-R Module			
Configuration:	Unknown			
Customer:	TDK-Lambda Americas Inc.			
Attendees:	Shuhui and Michael			
EUT Power:	230VAC/50Hz			
Operating Mode:	16,9 amp Load			
Deviations:	None			
Comments:	Heatsink tied to EGND			

Test Specifications	Class B	Test Method	
EN 55032:2012/AC:2013		CISPR 32:2015	

Run #	23	Line: High Line	Ext. Attenuation: 0	Results	Pass
--------------	----	------------------------	----------------------------	----------------	------

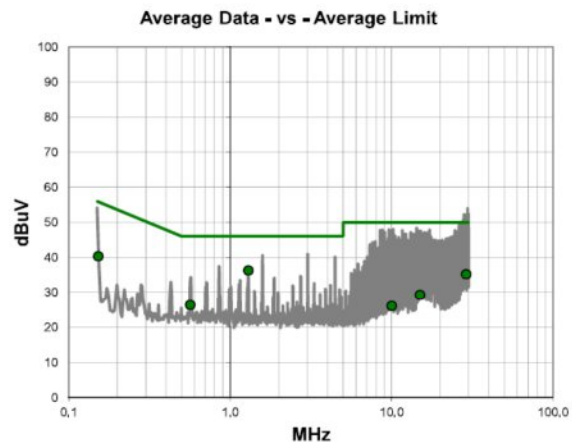
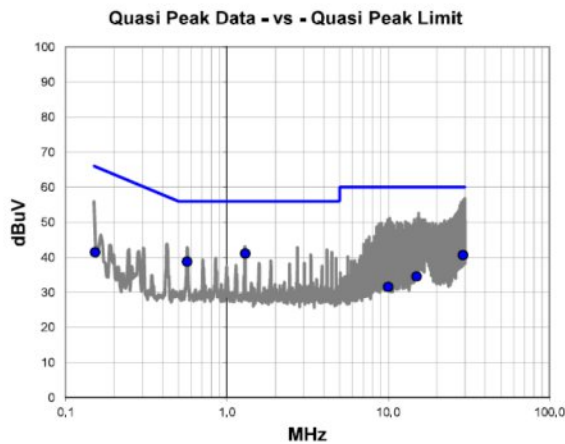

Quasi Peak Data - vs - Quasi Peak Limit

Freq (MHz)	Amplitude (dBuV)	Factor (dB)	Adjusted (dBuV)	Spec. Limit (dBuV)	Compared to Spec. (dB)
1,296	21,1	20,0	41,1	56,0	-14,9
28,992	18,8	21,9	40,7	60,0	-19,3
0,566	18,7	20,1	38,8	56,0	-17,2
0,153	21,2	20,3	41,5	65,9	-24,4
14,997	13,9	20,7	34,6	60,0	-25,4
9,995	11,1	20,5	31,6	60,0	-28,4

Average Data - vs - Average Limit

Freq (MHz)	Amplitude (dBuV)	Factor (dB)	Adjusted (dBuV)	Spec. Limit (dBuV)	Compared to Spec. (dB)
1,296	16,3	20,0	36,3	46,0	-9,7
28,992	13,3	21,9	35,2	50,0	-14,8
0,153	20,0	20,3	40,3	55,9	-15,6
14,997	8,6	20,7	29,3	50,0	-20,7
0,566	6,3	20,1	26,4	46,0	-19,6
9,995	5,6	20,5	26,1	50,0	-23,9

230V Neutral

CONDUCTED EMISSIONS



Work Order:	TDKL0022	Date:	1-May-2019	<small>EMIS 2018/20,26</small>	<small>PSA/SCI 2019/20,26</small>
Project:	None	Temperature:	22.1 °C		
Job Site:	TX01	Humidity:	53.4% RH		
Serial Number:	None	Barometric Pres.:	1017 mbar	Tested by:	Marty Martin
EUT:	PFH 500F-28V-100-R Module				
Configuration:	Unknown				
Customer:	TDK-Lambda Americas Inc.				
Attendees:	Shuhui and Michael				
EUT Power:	230VAC/50Hz				
Operating Mode:	16.9 amp Load				
Deviations:	None				
Comments:	Heatsink tied to EGND				
Test Specifications	Class B		Test Method		
EN 55032:2012/AC:2013			CISPR 32:2015		
Run #	22	Line:	Neutral	Ext. Attenuation:	0
Results	Pass				

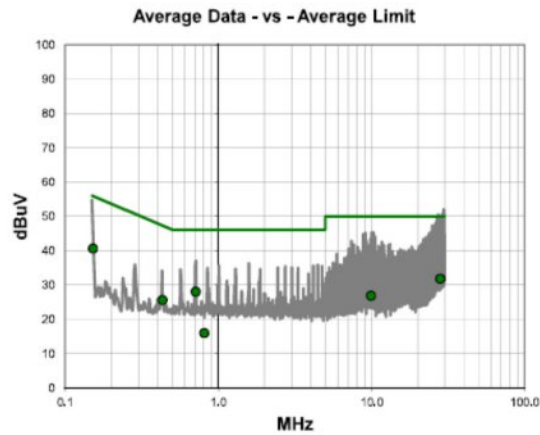
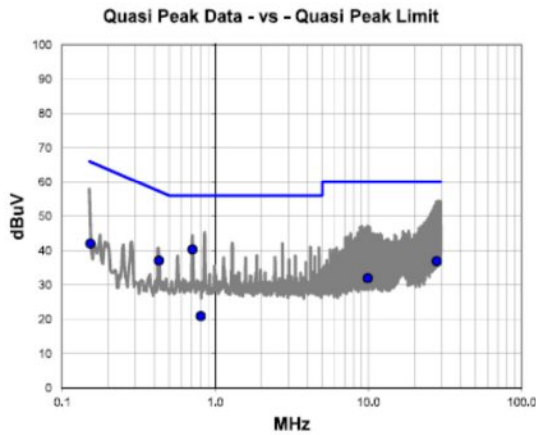

Quasi Peak Data - vs - Quasi Peak Limit

Freq (MHz)	Amplitude (dBuV)	Factor (dB)	Adjusted (dBuV)	Spec. Limit (dBuV)	Compared to Spec. (dB)
0,709	20,0	20,3	40,3	56,0	-15,7
28,009	15,1	21,8	36,9	60,0	-23,1
0,153	21,7	20,3	42,0	65,9	-23,9
9,895	11,5	20,5	32,0	60,0	-28,0
0,429	17,0	20,1	37,1	57,3	-20,2
0,806	0,7	20,2	20,9	56,0	-35,1

Average Data - vs - Average Limit

Freq (MHz)	Amplitude (dBuV)	Factor (dB)	Adjusted (dBuV)	Spec. Limit (dBuV)	Compared to Spec. (dB)
0,153	20,3	20,3	40,6	55,9	-15,3
28,009	10,0	21,8	31,8	50,0	-18,2
0,709	7,7	20,3	28,0	46,0	-18,0
9,895	6,3	20,5	26,8	50,0	-23,2
0,429	5,5	20,1	25,6	47,3	-21,7
0,806	-4,2	20,2	16,0	46,0	-30,0

Radiated EMI:

Certified Laboratory	Element Materials Technology Group Limited
Test Location	Plano, TX
Test Board	Test performed with the PFH500 module mounted on PFH500F Evaluation test Board (ZB00510)

Test Setup:



Test Result:

120V



RADIATED EMISSIONS

EUT:	AC/DC Power Supply	Work Order:	TDKL0004
Serial Number:	None	Date:	09/14/2017
Customer:	TDK-Lambda Americas Inc.	Temperature:	23.9°C
Attendees:	Michael Lawrence	Relative Humidity:	48.1%
Customer Project:	None	Bar. Pressure:	1014 mb
Tested By:	Marty Martin	Job Site:	TX02
Power:	120VAC/60Hz	Configuration:	TDKL0004-1

TEST SPECIFICATIONS

Specification: Equipment Class B EN 55032:2012/AC:2013	Method: CISPR 32:2015
---	--------------------------

TEST PARAMETERS

Run #:	10	Test Distance (m):	10	Ant. Height(s) (m):	1 to 4(m)
--------	----	--------------------	----	---------------------	-----------

COMMENTS

This is eval data only. 120VAC. Full load [internal]. 6T-31. Added grounding strap.

EUT OPERATING MODES

Typical Operating Mode

DEVIATIONS FROM TEST STANDARD

None

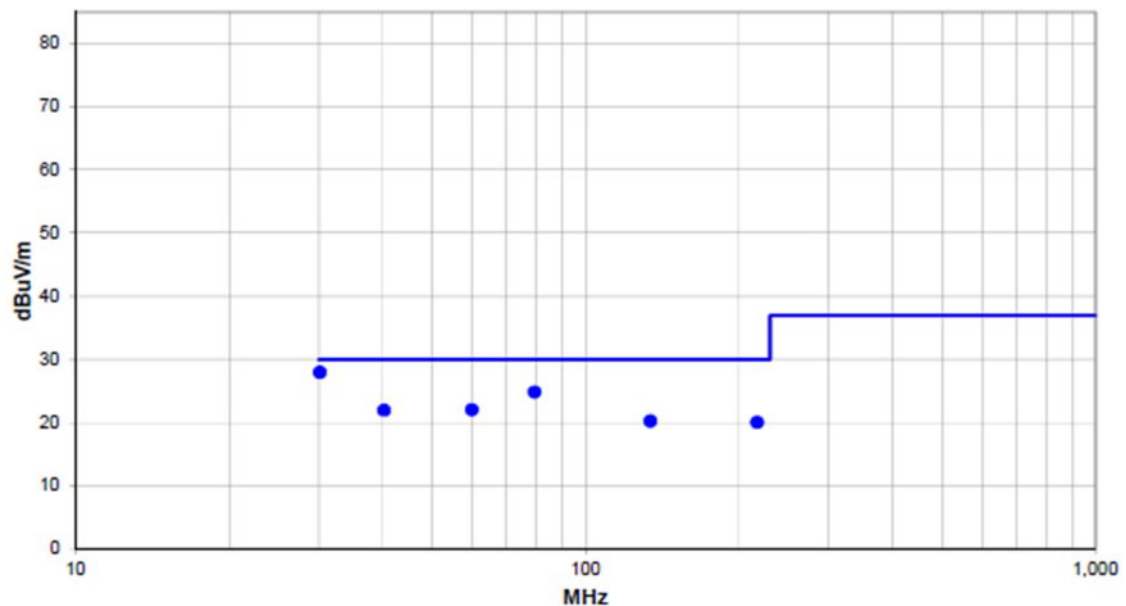

Run #: 10

■ PK ◆ AV ● QP

RADIATED EMISSIONS



RESULTS - Run #10

Freq (MHz)	Amp. (dBuV)	Factor (dB)	Ant. Height (m)	Azimuth (deg.)	Test Dist. (m)	Ext. Atten. (dB)	Polar. Trans. Type	Detect.	Dist. Adjust. (dB)	Adj. (dBuV/m)	Spec. Limit (dBuV/m)	Margin. (dB)
30.116	52.0	-24.0	1.5	169.0	10.0	0.0	Vert	QP	0.0	28.0	30.0	-2.0
79.437	57.1	-32.2	1.0	180.0	10.0	0.0	Vert	QP	0.0	24.9	30.0	-5.1
59.816	54.6	-32.5	1.5	351.0	10.0	0.0	Vert	QP	0.0	22.1	30.0	-7.9
40.248	51.0	-29.0	2.0	73.0	10.0	0.0	Vert	QP	0.0	22.0	30.0	-8.0
133.999	50.7	-30.4	2.0	90.0	10.0	0.0	Vert	QP	0.0	20.3	30.0	-9.7
216.994	47.1	-27.0	1.0	152.0	10.0	0.0	Vert	QP	0.0	20.1	30.0	-9.9

CONCLUSION
 Pass

FOR REFERENCE ONLY

230V



RADIATED EMISSIONS

EUT:	AC/DC Power Supply	Work Order:	TDKL0004
Serial Number:	None	Date:	09/14/2017
Customer:	TDK-Lambda Americas Inc.	Temperature:	23.9°C
Attendees:	Michael Lawrence	Relative Humidity:	48.1%
Customer Project:	None	Bar. Pressure:	1014 mb
Tested By:	Marty Martin	Job Site:	TX02
Power:	230VAC/50Hz	Configuration:	TDKL0004-1

TEST SPECIFICATIONS

Specification: Equipment Class B EN 55032:2012/AC:2013	Method: CISPR 32:2015
---	--------------------------

TEST PARAMETERS

Run #:	9	Test Distance (m):	10	Ant. Height(s) (m):	1 to 4(m)
--------	---	--------------------	----	---------------------	-----------

COMMENTS

This is eval data only. 230VAC, Full load [internal], 6T-31. Added grounding strap.

EUT OPERATING MODES

Typical Operating Mode

DEVIATIONS FROM TEST STANDARD

None

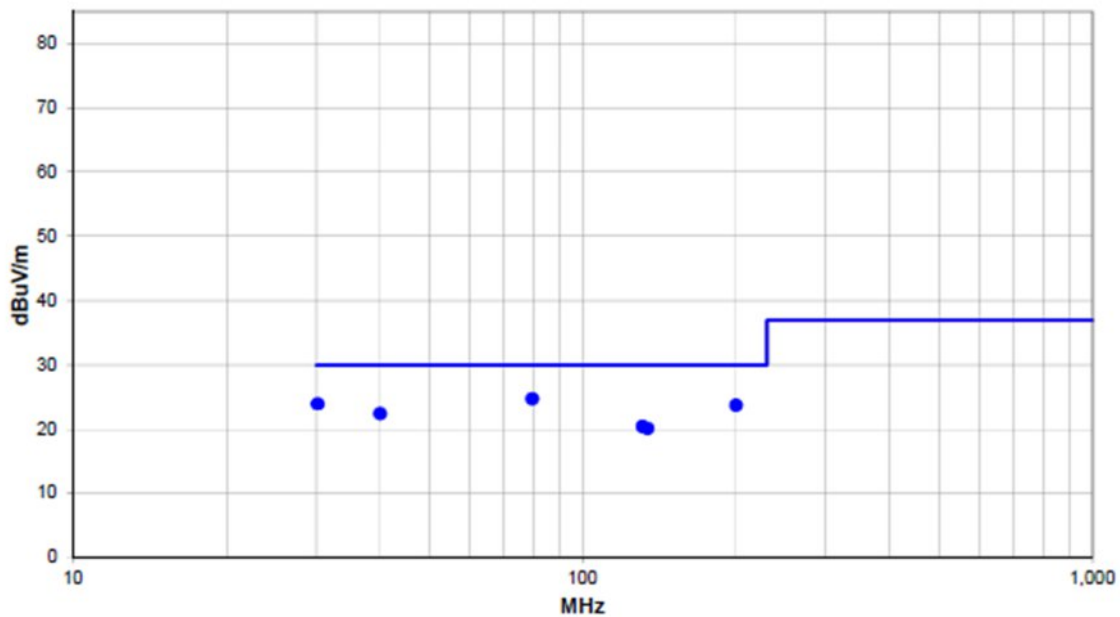

Run #: 9

PK AV QP



RADIATED EMISSIONS

RESULTS - Run #9

Freq (MHz)	Amp. (dBuV)	Factor (dB)	Ant. Height (m)	Azimuth (deg.)	Test Dist. (m)	Ext. Atten. (dB)	Polar. Trans. Type	Detect.	Dist. Adjust. (dB)	Ad. (dBuV/m)	Spec. Limit (dBuV/m)	Margin. (dB)
79.519	57.0	-32.2	1.5	186.0	10.0	0.0	Vert	QP	0.0	24.8	30.0	-5.2
30.166	48.0	-24.0	1.0	238.9	10.0	0.0	Vert	QP	0.0	24.0	30.0	-6.0
199.961	51.5	-27.7	1.0	270.0	10.0	0.0	Vert	QP	0.0	23.8	30.0	-6.2
40.003	51.4	-28.9	1.0	273.0	10.0	0.0	Vert	QP	0.0	22.5	30.0	-7.5
131.219	51.2	-30.7	1.1	75.0	10.0	0.0	Vert	QP	0.0	20.5	30.0	-9.5
134.144	50.6	-30.4	1.5	318.0	10.0	0.0	Vert	QP	0.0	20.2	30.0	-9.8

CONCLUSION
 Pass

FOR REFERENCE ONLY

2.14 Leakage Current (Refer to Section 1.1.4 for Test Setup)

Condition:	$V_{IN} = 265 \text{ VAC}$
	$I_o = 0\% (0 \text{ A})$
I_{LEAKAGE} LIMIT:	1 mA
Measured I_{LEAKAGE}:	0.62 mA
	PASS

3. TERMINOLOGIES

V_{IN}	Input Voltage
I_{IN}	Input Current
T_a	Ambient Temperature
F	Frequency
V_o	Output Voltage
I_o	Output Current
T_{BP}	Baseplate Temperature



401 Mile Cars Way, Suite 125
 National City, CA 91950
 Phone (800) 526-2324 Toll Free

Lambda.TechSupport@us.tdk-lambda.com
www.us.tdk-lambda.com/lp/

Information furnished by TDK Lambda is believed to be accurate and reliable. However, TDK Lambda assumes no responsibility for its use, nor for any infringement of patents or other rights of third parties, which may result from its use. No license is granted by implication or otherwise under any patent or patent rights of TDK Lambda. TDK components are not designed to be used in applications, such as life support systems, wherein failure or malfunction could result in injury or death. All sales are subject to TDK Lambda's Terms and Conditions of Sale, which are available upon request. Specifications are subject to change without notice.