

RWS100B

EVALUATION DATA

型式データ

INDEX

1. 測定方法	Evaluation Method	PAGE
1.1	測定回路 Circuit used for determination	
	測定回路1 Circuit 1 used for determination	T-1
	静特性 Steady state data	
	通電ドリフト特性 Warm up voltage drift characteristics	
	出力保持時間特性 Hold up time characteristics	
	出力立ち上がり特性 Output rise characteristics	
	出力立ち下がり特性 Output fall characteristics	
	過電流保護特性 Over current protection (OCP) characteristics	
	過電圧保護特性 Over voltage protection (OVP) characteristics	
	入力電圧瞬停特性 Response to brown out characteristics	
	入力電流波形 Input current waveform	
	測定回路2 Circuit 2 used for determination	T-1
	過渡応答 (負荷急変) 特性 Dynamic load response characteristics	
	測定回路3 Circuit 3 used for determination	T-2
	入力サージ電流 (突入電流) 波形 Inrush current waveform	
	入力電流波形 Input current waveform	
	測定回路4 Circuit 4 used for determination	T-2
	リーク電流特性 Leakage current characteristics	
	測定回路5 Circuit 5 used for determination	T-3
	出力リップル、ノイズ波形 Output ripple and noise waveform	
	測定構成 Configuration used for determination	T-3
	EMI特性 Electro-Magnetic Interference characteristics	
	(a) 雑音端子電圧 (帰還ノイズ) Conducted Emission	
	(b) 雑音電界強度 (放射ノイズ) Radiated Emission	
1.2	使用測定機器 List of equipment used	T-4
1.3	評価負荷条件 Load conditions	T-4

2. 特性データ Characteristics

2.1	静特性	Steady state data	
(1)	入力・負荷・温度変動／出力起動・遮断電圧	Regulation - line and load, Temperature drift / Start up voltage and Drop out voltage	T-5
(2)	リップルノイズ電圧対入力電圧・出力電流	Ripple noise voltage vs. Input voltage.....	T-6
(3)	効率・力率対出力電流	Efficiency and Power factor vs. Output current	T-7
(4)	入力電力対出力電流	Input power vs. Output current	T-8
(5)	入力電流対出力電流	Input current vs. Output current	T-9
2.2	通電ドリフト特性	Warm up voltage drift characteristics	T-10
2.3	出力保持時間特性	Hold up time characteristics	T-10
2.4	出力立ち上がり特性	Output rise characteristics	T-11
2.5	出力立ち下がり特性	Output fall characteristics	T-12
2.6	過電流保護特性	Over current protection (OCP) characteristics	T-13
2.7	過電圧保護特性	Over voltage protection (OVP) characteristics	T-13
2.8	過渡応答（負荷急変）特性	Dynamic load response characteristics	T-14
2.9	入力電圧瞬停特性	Response to brown out characteristics	T-15
2.10	入力サージ電流（突入電流）波形	Inrush current waveform	T-16
2.11	高調波成分	Input current harmonics	T-17
2.12	入力電流波形	Input current waveform	T-17
2.13	リーク電流特性	Leakage current characteristics	T-18
2.14	出力リップル、ノイズ波形	Output ripple and noise waveform	T-19
2.15	EMI特性	Electro-Magnetic Interference characteristics	T-20～23

使用記号 Terminology used

	定義	Definition
V_{in}	入力電圧 Input voltage
V_{out}	出力電圧 Output voltage
I_{in}	入力電流 Input current
I_{out}	出力電流 Output current
T_a	周囲温度 Ambient temperature
f	周波数 Frequency

1. 測定方法 Evaluation Method

1.1 測定回路 Circuit used for determination

測定回路1 Circuit 1 used for determination

- 静特性 Steady state data
- 通電ドリフト特性 Warm up voltage drift characteristics
- 出力保持時間特性 Hold up time characteristics
- 出力立ち上がり特性 Output rise characteristics
- 出力立ち下がり特性 Output fall characteristics
- 過電流保護特性 Over current protection (OCP) characteristics
- 過電圧保護特性 Over voltage protection (OVP) characteristics
- 入力電圧瞬停特性 Response to brown out characteristics
- 入力電流波形 Input current waveform

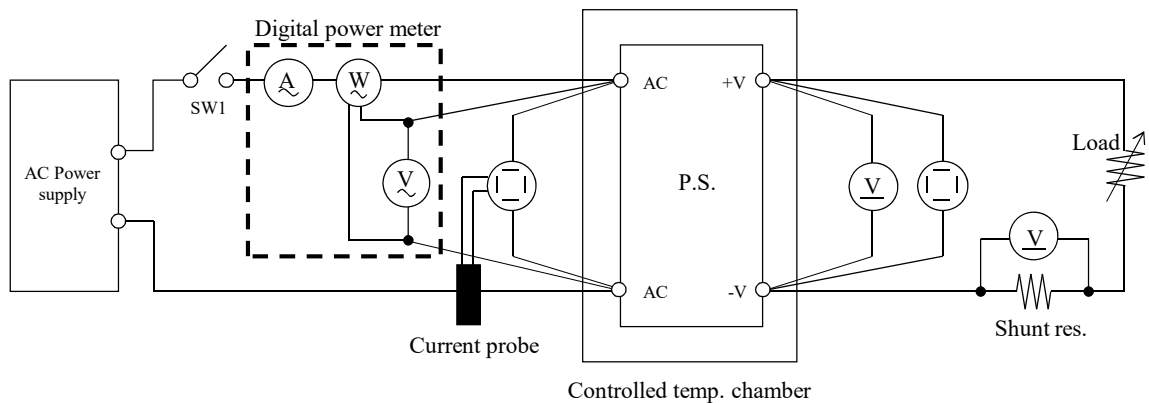

測定回路2 Circuit 2 used for determination

- 過渡応答 (負荷急変) 特性 Dynamic load response characteristics

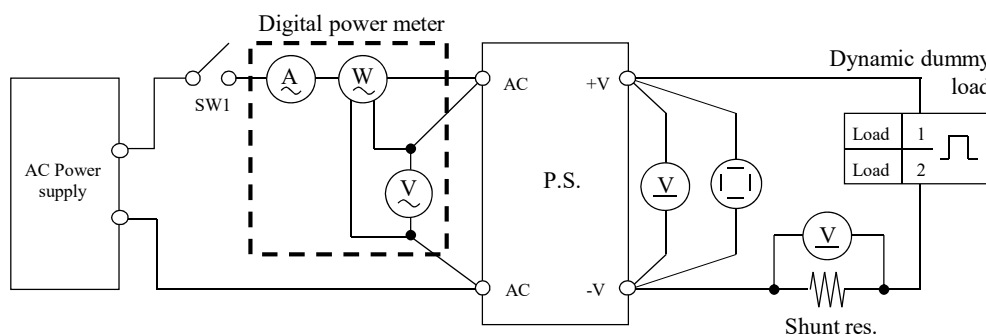

Output current waveform
Iout 50% <=> 100%

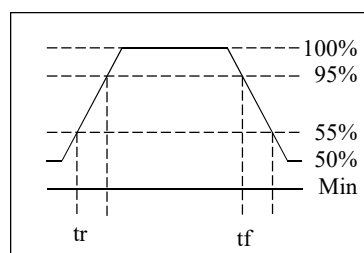

測定回路3 Circuit 3 used for determination

・入力サージ電流 (突入電流) 波形 Inrush current waveform

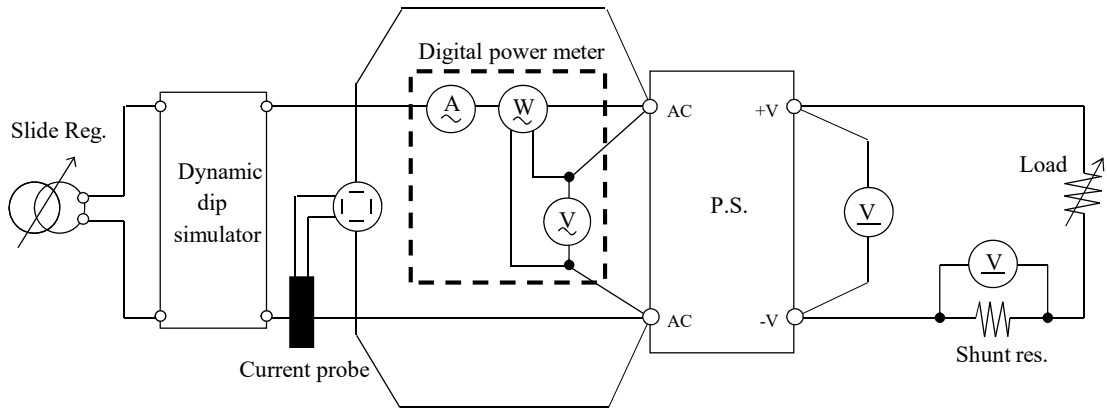

測定回路4 Circuit 4 used for determination

・リーク電流特性 Leakage current characteristics

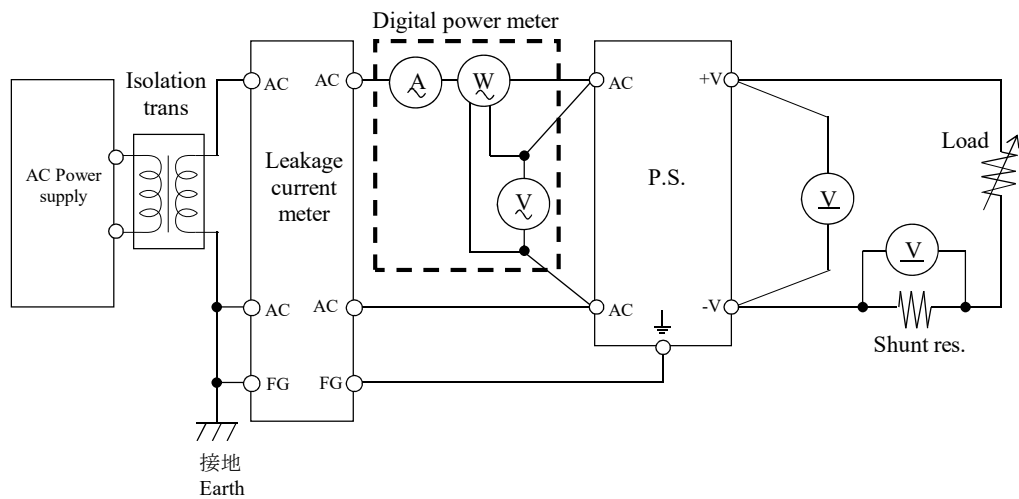

測定回路5 Circuit 5 used for determination

・出力リップル、ノイズ波形 Output ripple and noise waveform

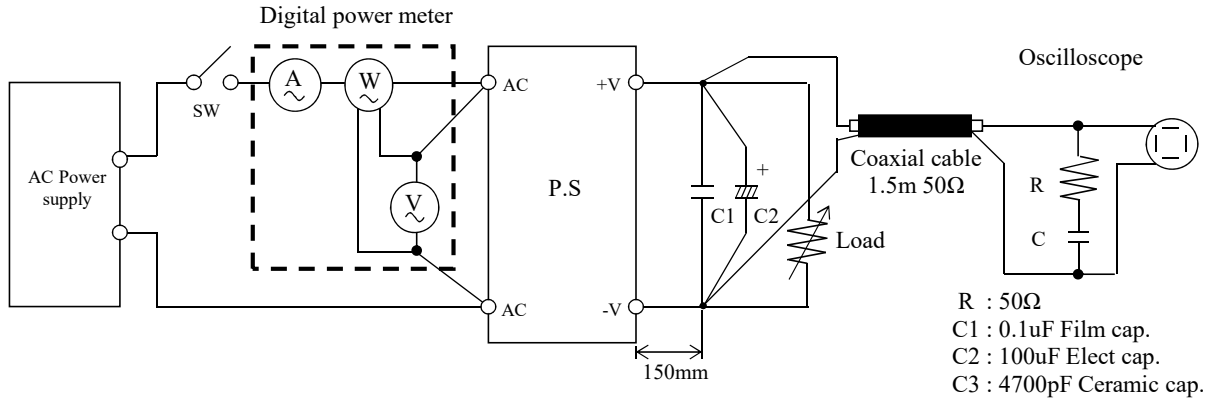

測定構成 Configuration used for determination

・EMI特性 Electro-Magnetic Interference characteristics

(a) 雑音端子電圧 (帰還ノイズ)

Conducted Emission

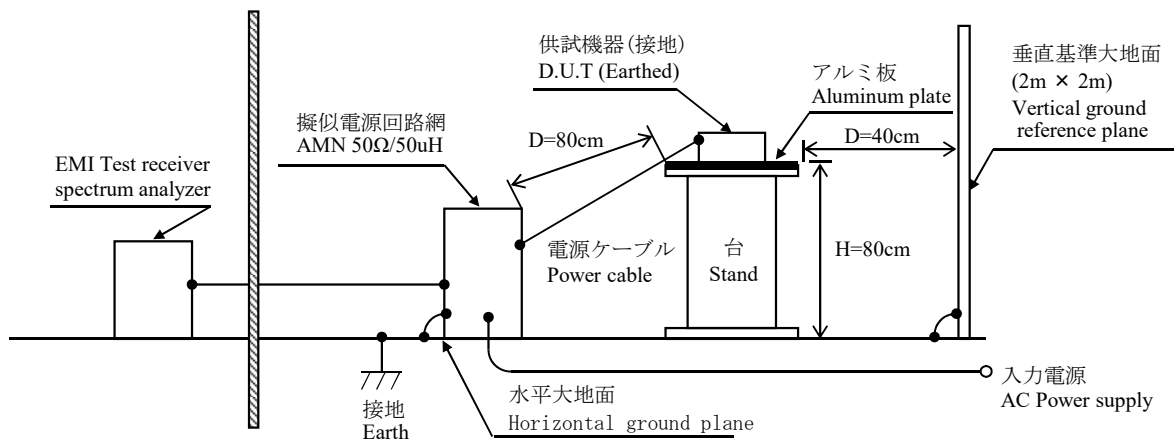

(b) 雑音電界強度 (放射ノイズ)

Radiated Emission

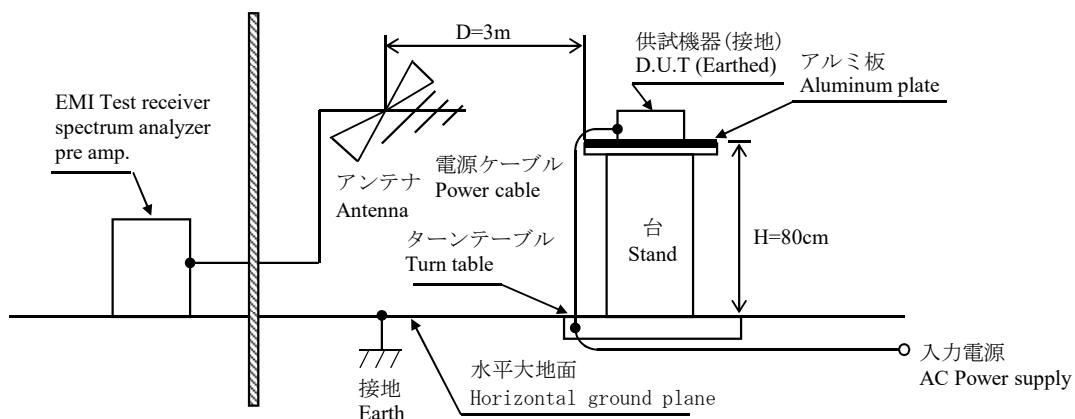

1.2 使用測定機器 List of equipment used

	EQUIPMENT USED	MANUFACTURER	MODEL NO.
1	DIGITAL STORAGE OSCILLOSCOPE	YOKOGAWA ELECT.	DLM2054
2	DIGITAL MULTIMETER	AGILENT	34405A/34410A
3	DIGITAL POWER METER	YOKOGAWA ELECT.	WT110 / WT210
4	CURRENT PROBE	YOKOGAWA ELECT.	701930 / 701933
5	DYNAMIC DUMMY LOAD	CHROMA	63640
6	DUMMY LOAD	CHROMA	63640
7	ISOLATION TRANS	TOUZHONG	BJZ-3KVA
8	CVCF	KIKUSUI	PCR2000LE
9	CVCF	KIKUSUI	PCR3000LE
10	CVCF	CHROMA	61605
11	LEAKAGE CURRENT METER	SIMPSON	228
12	CONTROLLED TEMP. CHAMBER	ESPEC	SU-661 / SH-661
13	EMI TEST RECEIVER / SPECTRUM ANALYZER	ROHDE & SCHWARZ	ESCI-03
14	PRE AMP.	AGILENT	8447D
15	AMN	SCHWARZBECK	NNLK8121
16	ANTENNA	SCHWARZBECK	VULB9168
17	HARMONIC / FLICKER ANALYZER	SCHAFFNER	CCN100-1

1.3 評価負荷条件 Load conditions

*入力電圧が110VAC以下の場合、下記のとおり出力デレーティングが必要です。
Output derating is needed when input voltage is less than 110VAC.

Output voltage : 5V

Vin	Iout: Full load	5V
85VAC	90%	12.6A
90 - 265VAC	100%	14A

Output voltage : 12V, 24V

Vin	Iout: Full load	12V	24V
85VAC	80%	6.8A	3.6A
100VAC	92%	7.82A	4.14A
110 - 265VAC	100%	8.5A	4.5A

2. 特性データ

Characteristics

2.1 静特性 Steady state data

(1) 入力・負荷・温度変動／出力起動・遮断電圧

Regulation - line and load, Temperature drift / Start up voltage and Drop out voltage

5V		1. Regulation - line and load				Condition Ta : 25 °C	
Iout \ Vin	90VAC	100VAC	200VAC	265VAC	line regulation		
0%	5.048V	5.048V	5.048V	5.048V	0mV	0.000%	
50%	5.043V	5.043V	5.043V	5.043V	0mV	0.000%	
Full load	5.032V	5.032V	5.032V	5.032V	0mV	0.000%	
Load regulation	16mV	16mV	16mV	16mV			
	0.320%	0.320%	0.320%	0.320%			

2. Temperature drift		Conditions Vin : 100 VAC Iout : Full load			
Ta	-10°C	+25°C	+40°C	temperature stability	
Vout	5.039V	5.032V	5.025V	14mV	0.280%

3. Start up voltage and Drop out voltage		Conditions Ta : 25 °C Iout : 100%	
Start up voltage (Vin)	78VAC		
Drop out voltage (Vin)	74VAC		

12V		1. Regulation - line and load				Condition Ta : 25 °C	
Iout \ Vin	100VAC	110VAC	200VAC	265VAC	line regulation		
0%	12.019V	12.019V	12.019V	12.019V	0mV	0.000%	
50%	12.015V	12.016V	12.015V	12.016V	1mV	0.008%	
Full load	12.010V	12.009V	12.009V	12.009V	0mV _{※1}	0.000%	
Load regulation	9mV	10mV	10mV	10mV			
	0.075%	0.083%	0.083%	0.083%			

2. Temperature drift		Conditions Vin : 110 VAC Iout : Full load			
Ta	-10°C	+25°C	+40°C	temperature stability	
Vout	12.024V	12.009V	12.000V	24mV	0.200%

3. Start up voltage and Drop out voltage		Conditions Ta : 25 °C Iout : 100%	
Start up voltage (Vin)	78VAC		
Drop out voltage (Vin)	74VAC		

24V		1. Regulation - line and load				Condition Ta : 25 °C	
Iout \ Vin	100VAC	110VAC	200VAC	265VAC	line regulation		
0%	24.052V	24.052V	24.052V	24.052V	0mV	0.000%	
50%	24.049V	24.049V	24.048V	24.048V	1mV	0.004%	
Full load	24.047V	24.046V	24.046V	24.046V	0mV _{※1}	0.000%	
Load regulation	5mV	6mV	6mV	6mV			
	0.021%	0.025%	0.025%	0.025%			

2. Temperature drift		Conditions Vin : 110 VAC Iout : Full load			
Ta	-10°C	+25°C	+40°C	temperature stability	
Vout	24.064V	24.046V	24.030V	34mV	0.142%

3. Start up voltage and Drop out voltage		Conditions Ta : 25 °C Iout : 100%	
Start up voltage (Vin)	78VAC		
Drop out voltage (Vin)	74VAC		

※1 Line regulation (12V,24V) : 110VAC - 265VAC

(2) リップルノイズ電圧対入力電圧
Ripple noise voltage vs. Input voltage

Conditions Iout : Full load
 Ta : -10 °C ---
 25 °C -.-
 40 °C —

5V

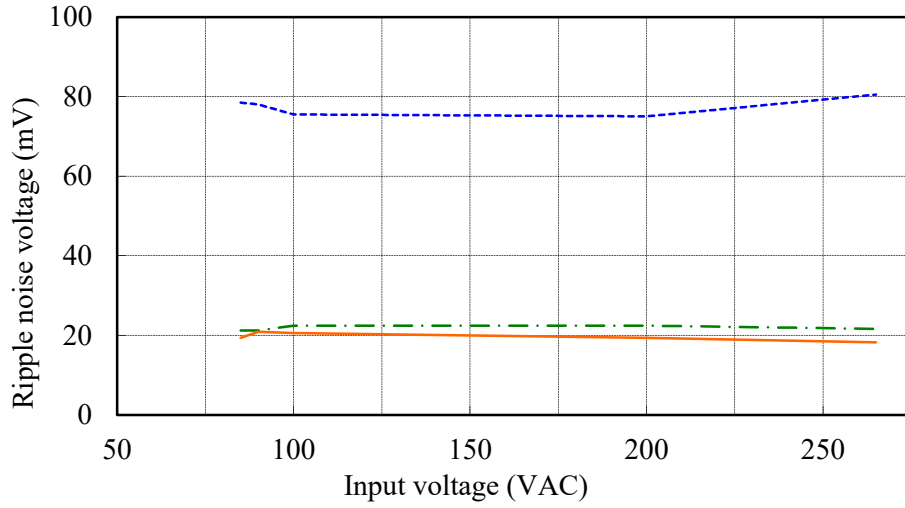

12V

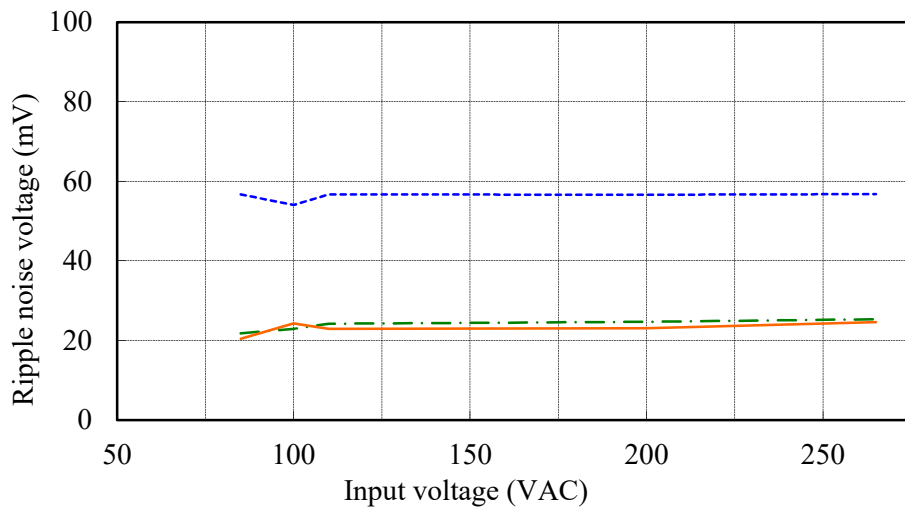

24V

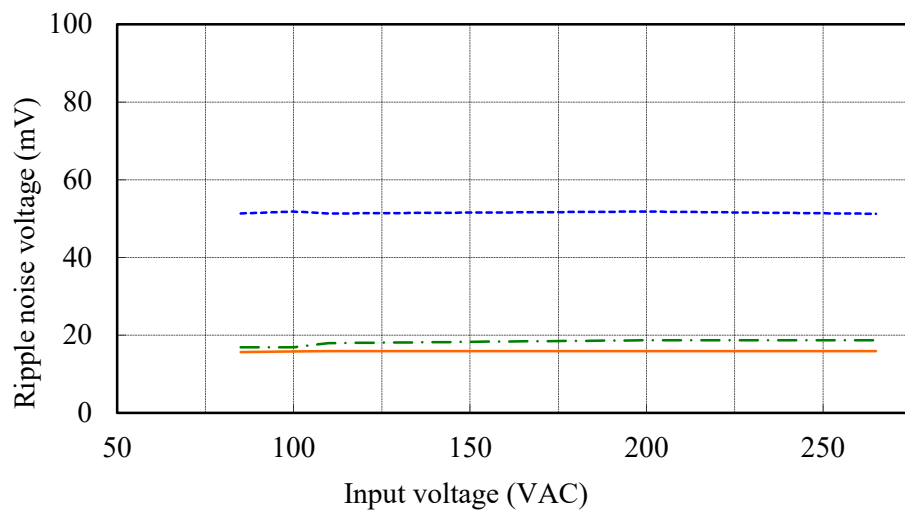

(3) 効率・力率対出力電流

Efficiency and Power factor vs. Output current

Conditions Vin : 90 VAC ---
 100 VAC ---
 110 VAC ---
 200 VAC ---
 265 VAC ---
 Ta : 25 °C

5V

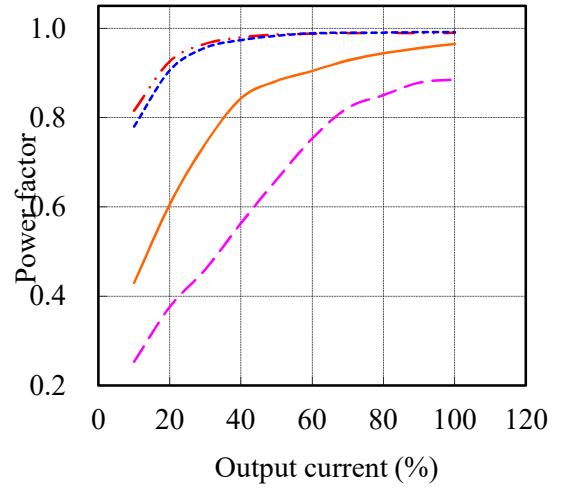
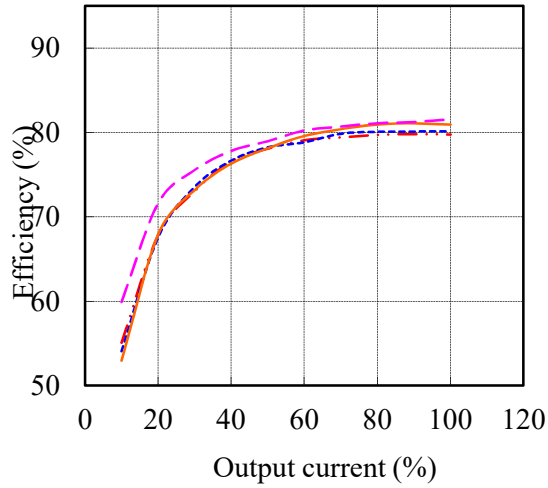

12V

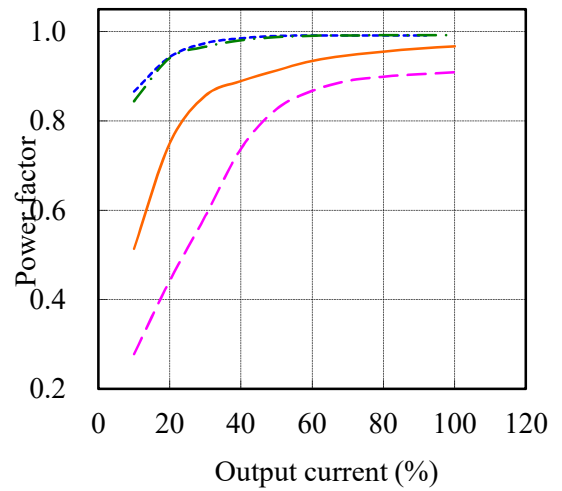
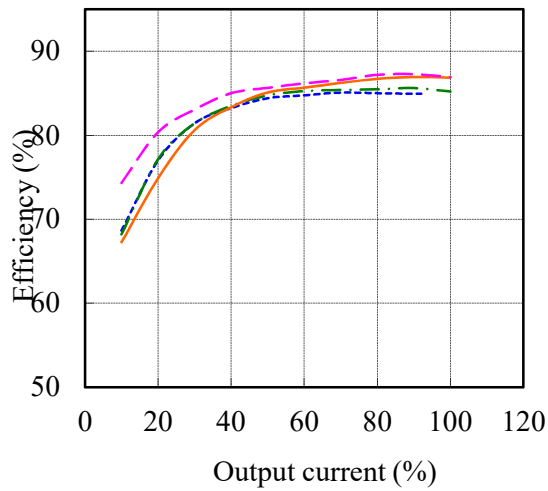

24V

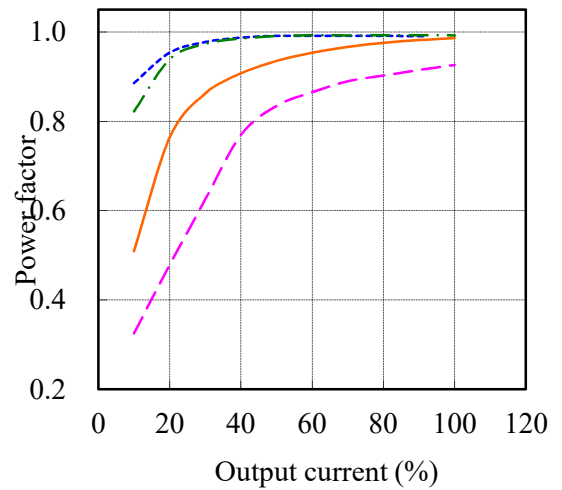
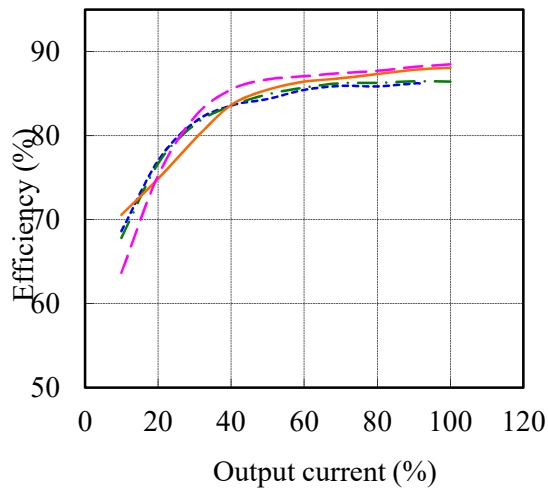

(4) 入力電力対出力電流

Input power vs. Output current

Conditions Vin : 90 VAC — · · ·
 100 VAC - - -
 110 VAC - · · ·
 200 VAC —
 265 VAC —
 Ta : 25 °C

5V

Vin	Input power
	Iout : 0%
90VAC	2.2W
100VAC	1.9W
200VAC	1.7W
265VAC	1.5W

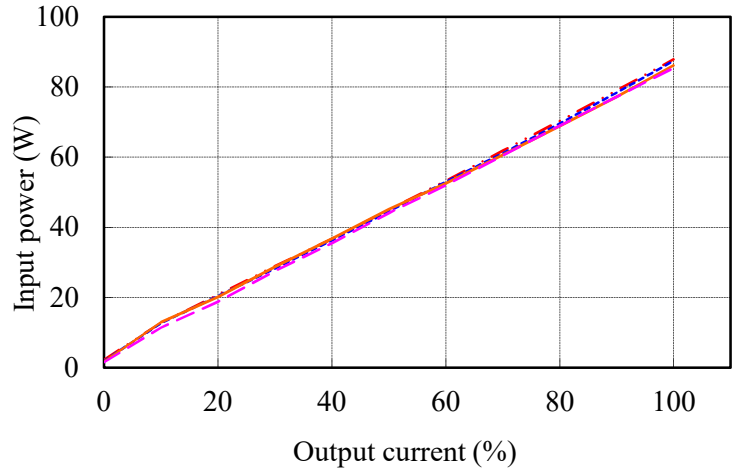

12V

Vin	Input power
	Iout : 0%
100VAC	1.8W
110VAC	1.8W
200VAC	1.5W
265VAC	1.3W

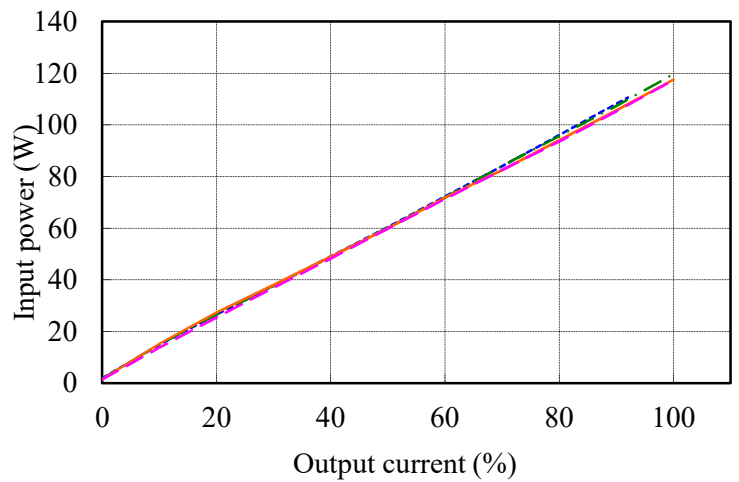

24V

Vin	Input power
	Iout : 0%
100VAC	1.9W
110VAC	1.9W
200VAC	1.7W
265VAC	1.4W

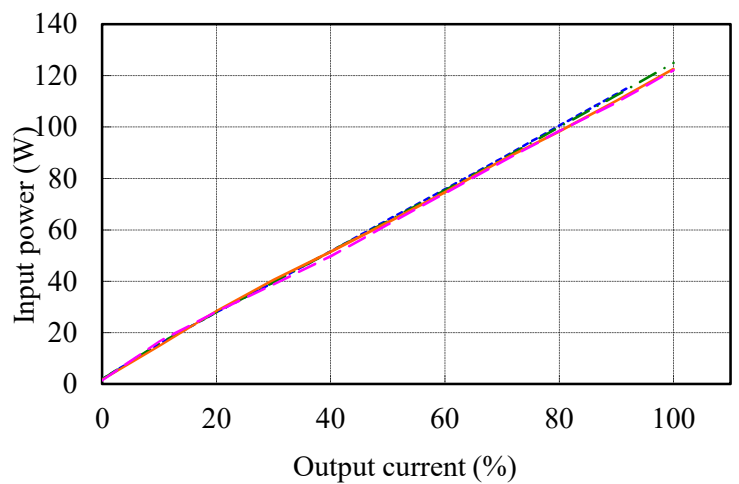

(5) 入力電流対出力電流

Input current vs. Output current

Conditions Vin : 90 VAC — · —
 100 VAC - - -
 110 VAC · · ·
 200 VAC — — —
 265 VAC - · -
 Ta : 25 °C

5V

Vin	Input current
	Iout : 0%
90VAC	0.06A
100VAC	0.07A
200VAC	0.07A
265VAC	0.08A

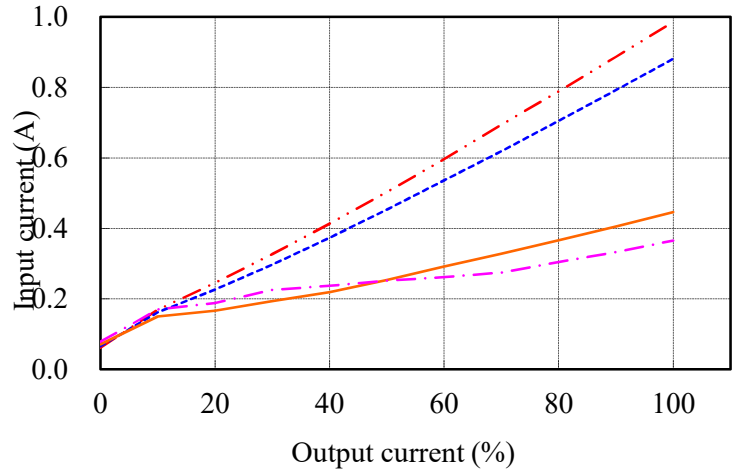

12V

Vin	Input current
	Iout : 0%
100VAC	0.06A
110VAC	0.07A
200VAC	0.07A
265VAC	0.08A

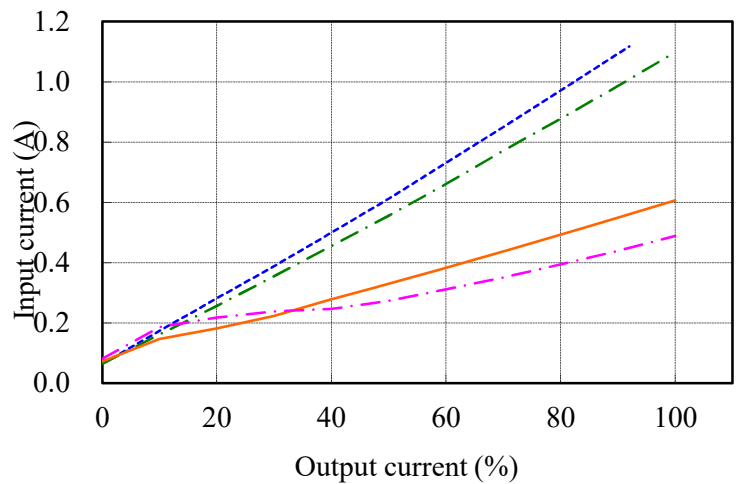

24V

Vin	Input current
	Iout : 0%
100VAC	0.07A
110VAC	0.07A
200VAC	0.07A
265VAC	0.08A

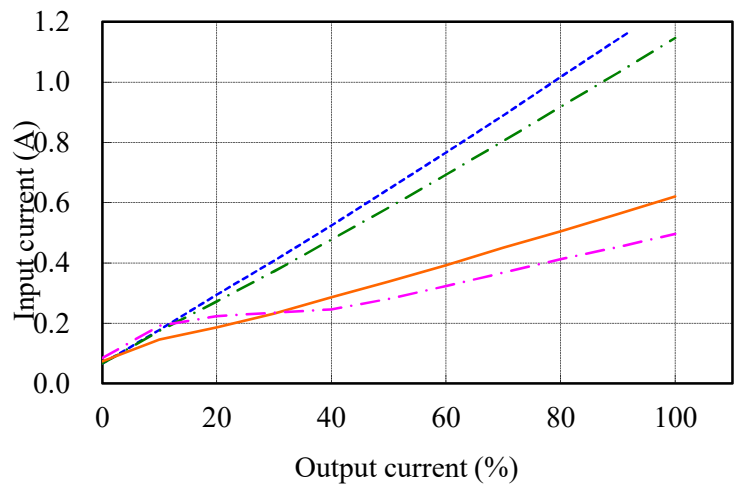

2.2 通電ドリフト特性

Warm up voltage drift characteristics

Conditions Vin : 110 VAC
Iout : Full load
Ta : 25 °C

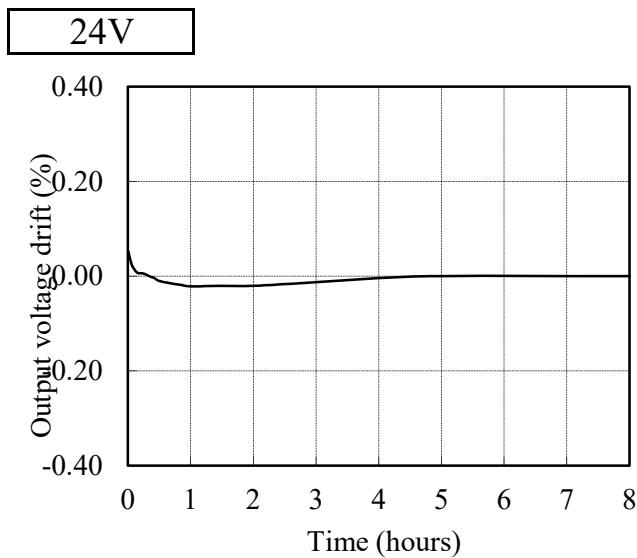
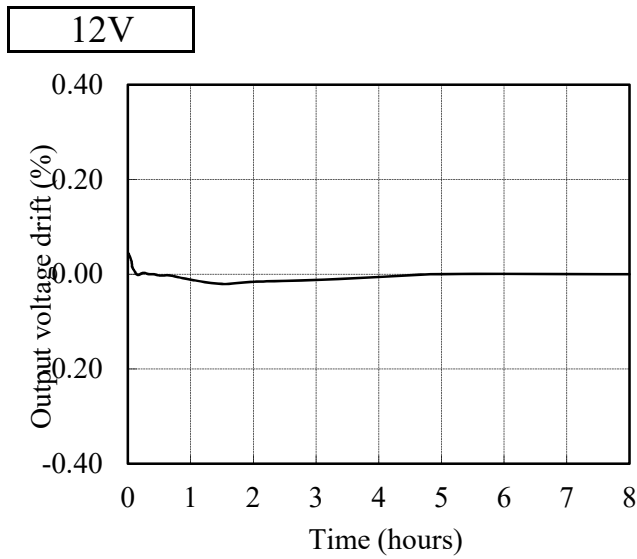
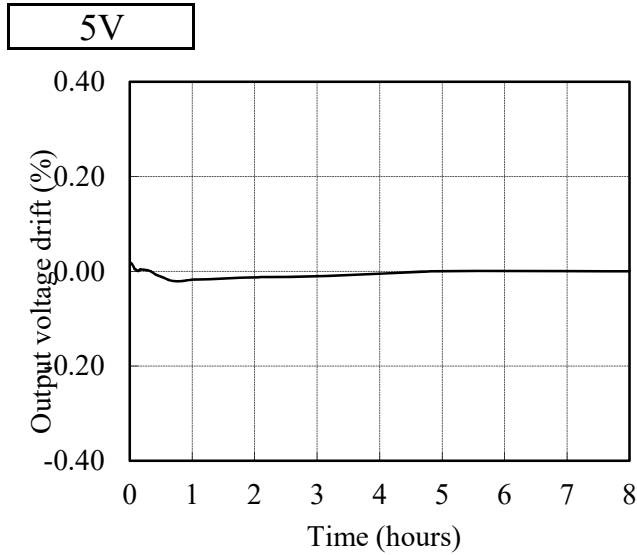

2.3 出力保持時間特性

Hold up time characteristics

Conditions Vin : 110 VAC ———
200 VAC - - - -
Ta : 25 °C

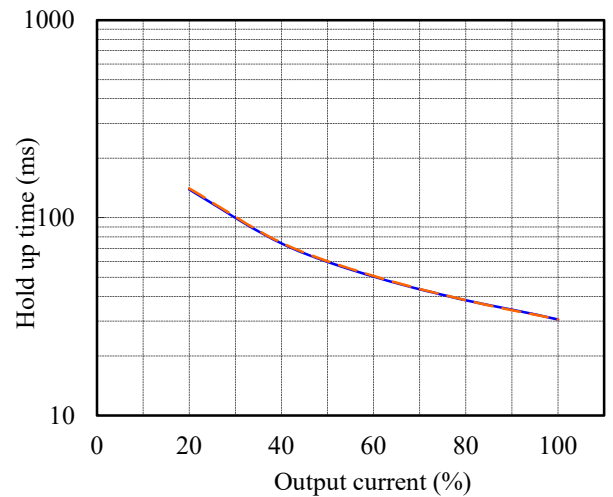
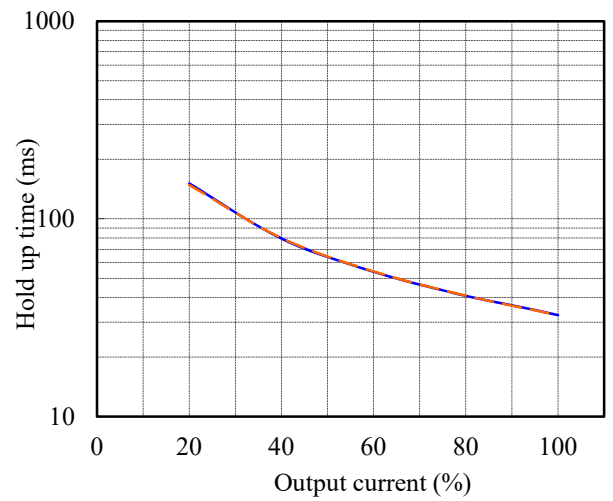
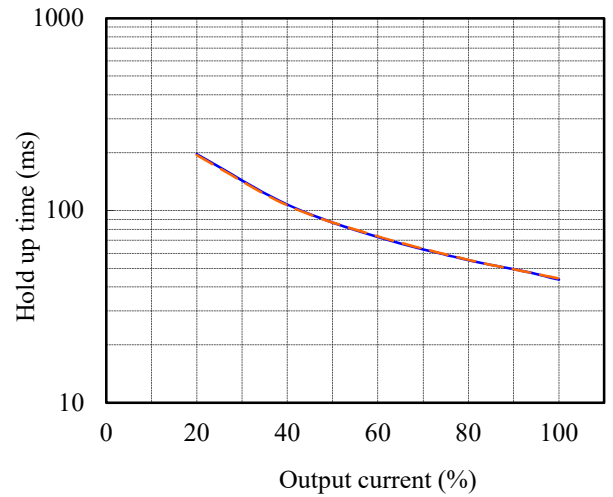

2.4 出力立ち上がり特性

Output rise characteristics

Conditions V_{in} : 100 VAC (A)
 110 VAC (B)
 200 VAC (C)
 265 VAC (D)
 T_a : 25 °C

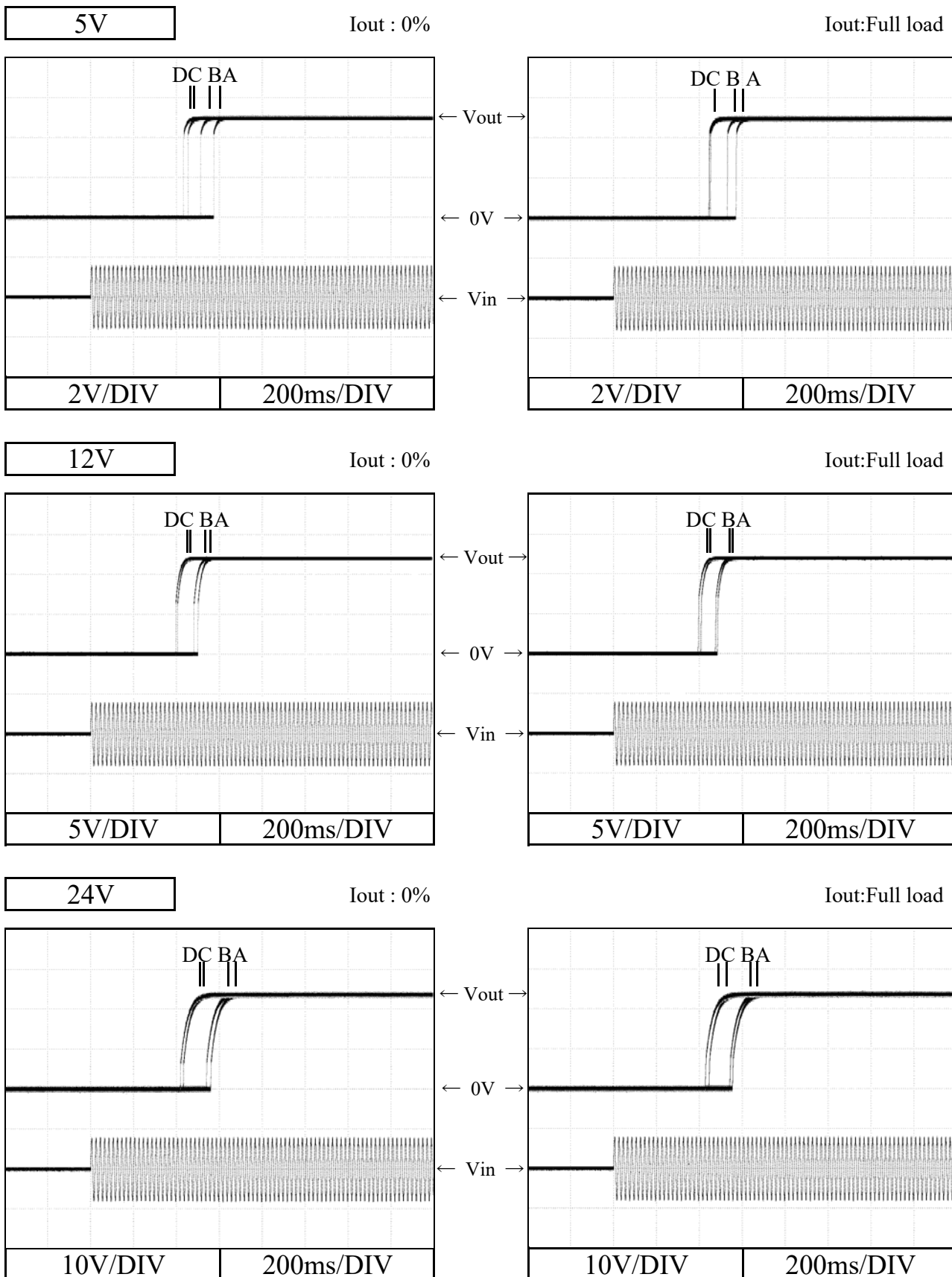

2.5 出力立ち下がり特性
Output fall characteristics

RWS100B

Conditions Vin : 100 VAC (A)
110 VAC (B)
200 VAC (C)
265 VAC (D)
Ta : 25 °C

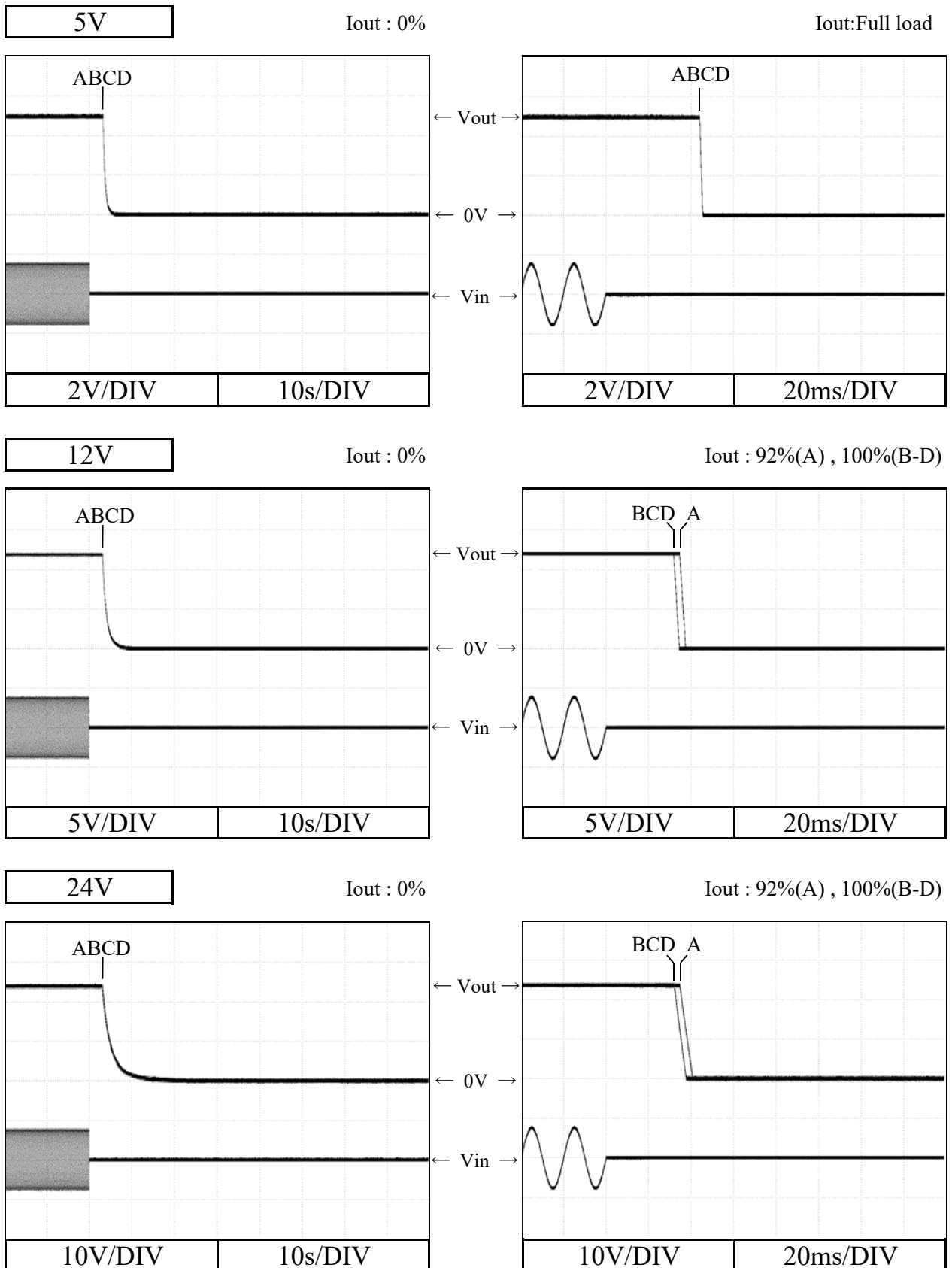

2.6 過電流保護特性

Over current protection (OCP) characteristics

Conditions Vin : 110 VAC

Ta : -10 °C ————
 25 °C - · - · -
 40 °C ————

5V

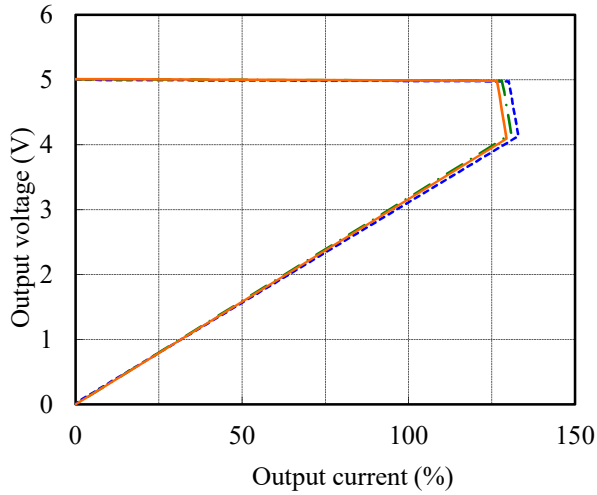

12V

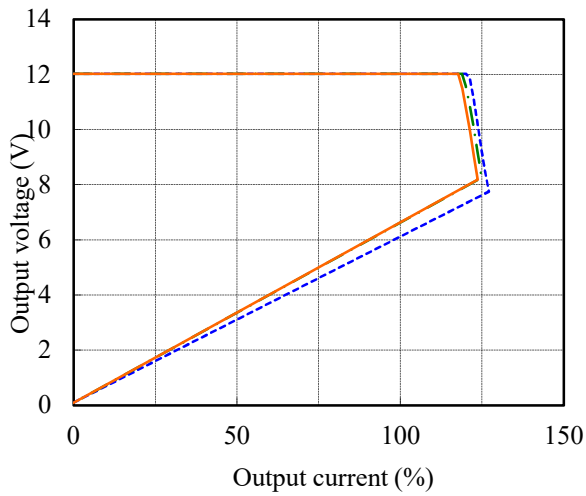

24V

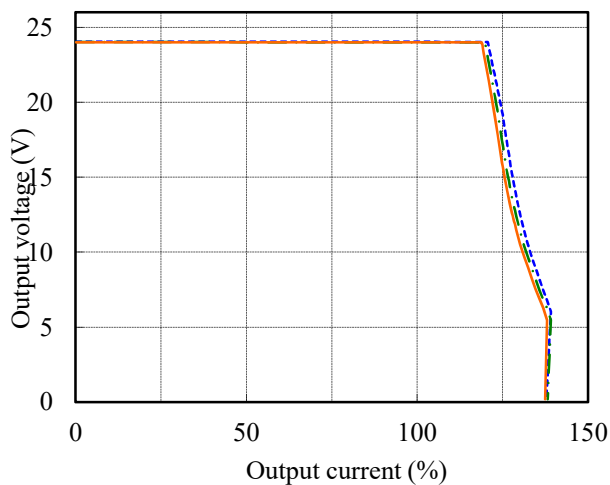

2.7 過電圧保護特性

Over voltage protection (OVP) characteristics

Conditions Vin : 100 VAC

Iout : 0 %
 Ta : 25 °C

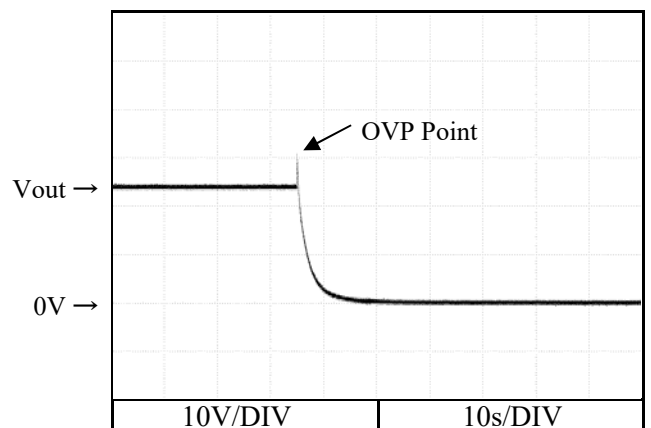
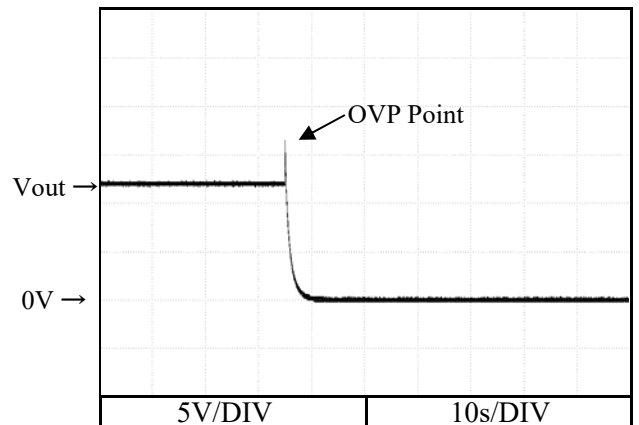
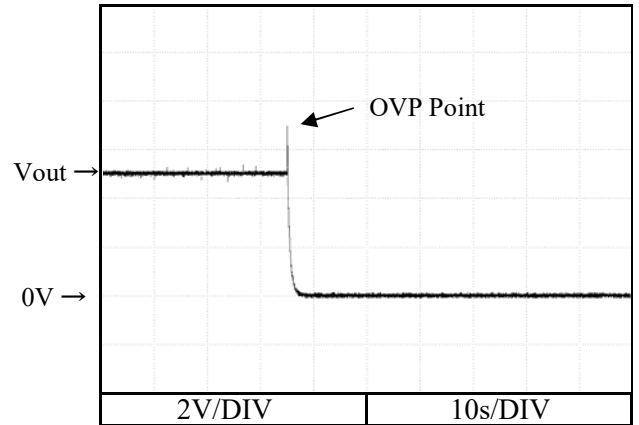

2.8 過渡応答（負荷急変）特性

Dynamic load response characteristics

Conditions Vin : 110 VAC
 Iout : 50 % ↔ 100 %
 (tr = tf = 50us)
 Ta : 25 °C

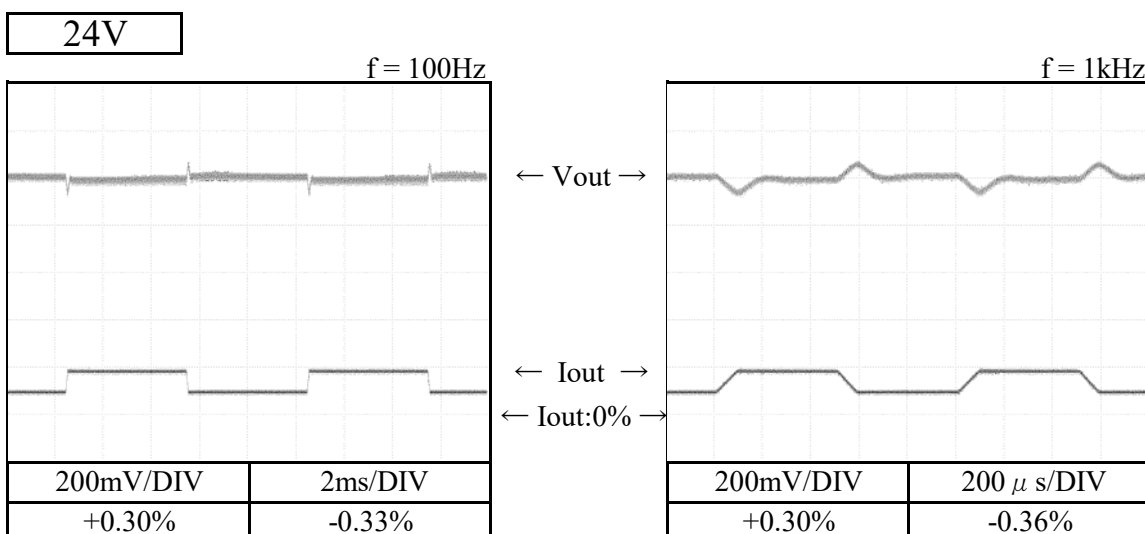
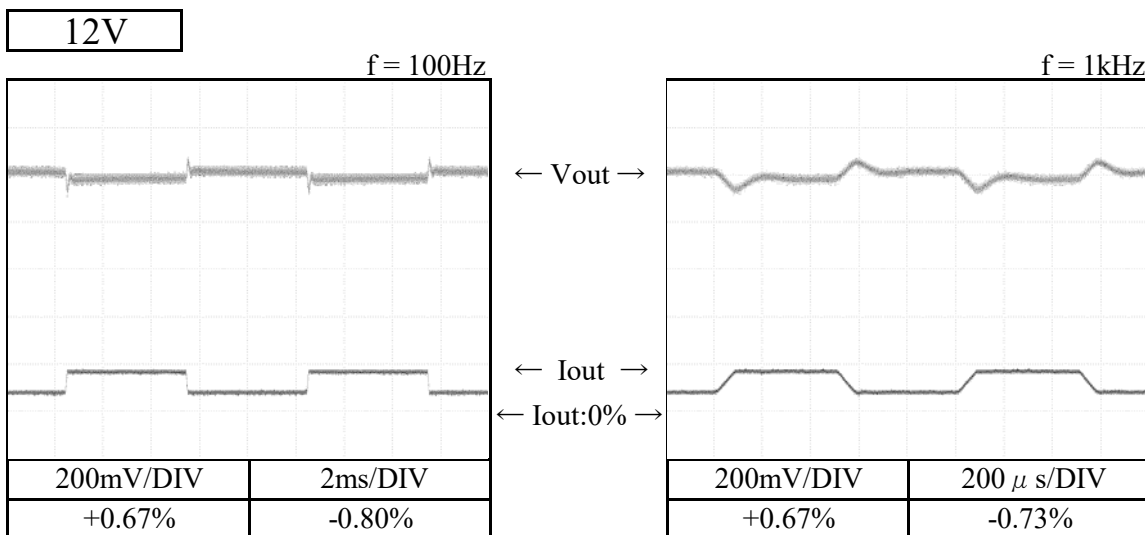
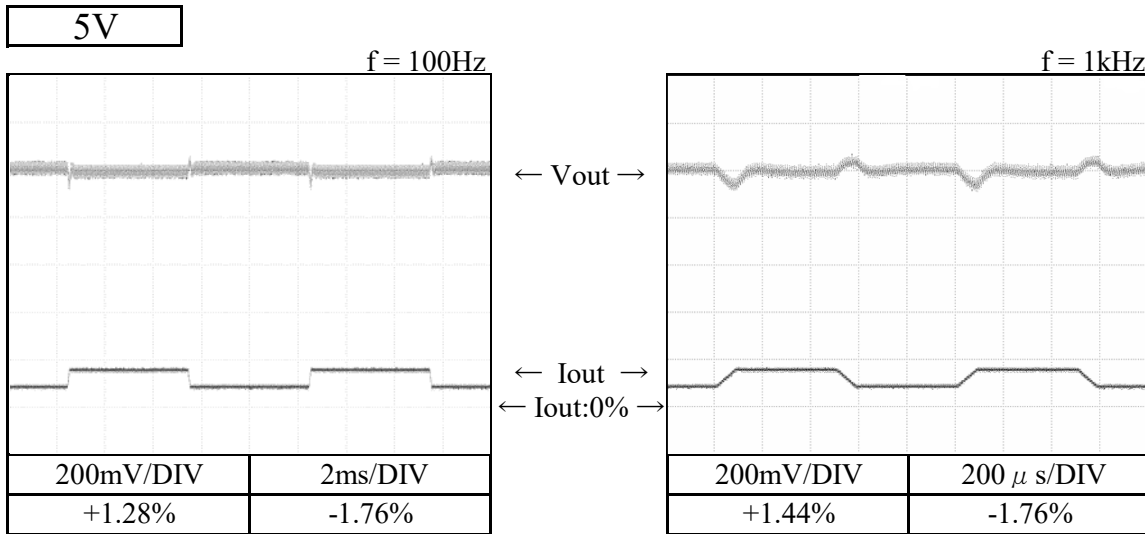

2.9 入力電圧瞬停特性

Response to brown out characteristics

Conditions T_a : 25 °C
 I_{out} : Full load

瞬停時間 Interruption time

A : 出力電圧が低下なし Output voltage does not drop.

B : 出力電圧の低下が0Vまでいかない Output voltage drop down not reaching 0V.

C : 出力電圧が0Vまで低下 Output voltage drops until 0V.

5V

V_{in} : 110VAC

A = 44ms, C = 45ms

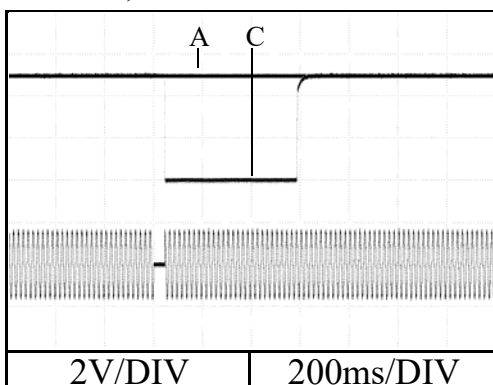

V_{in} : 200VAC

A = 45ms, C = 46ms

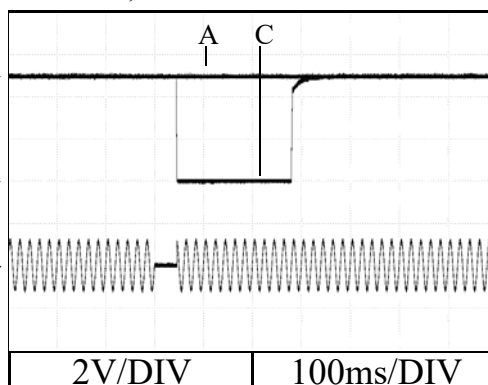

12V

V_{in} : 110VAC

A = 33ms, C = 34ms

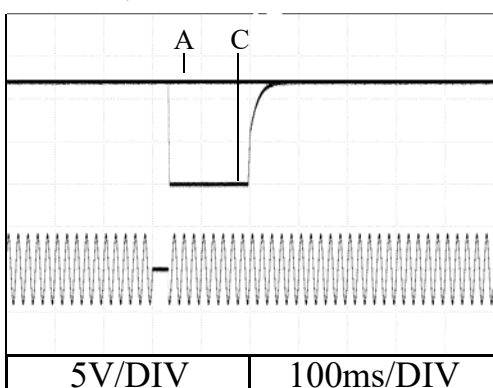

V_{in} : 200VAC

A = 33ms, C = 34ms

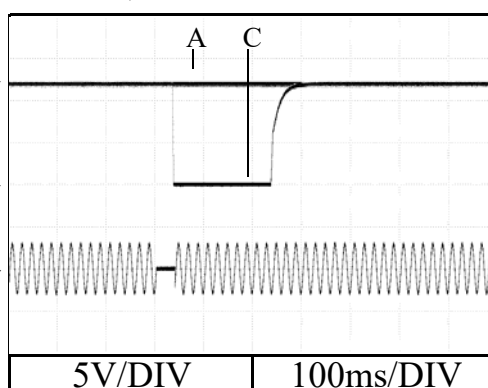

24V

V_{in} : 110VAC

A = 30ms, C = 31ms

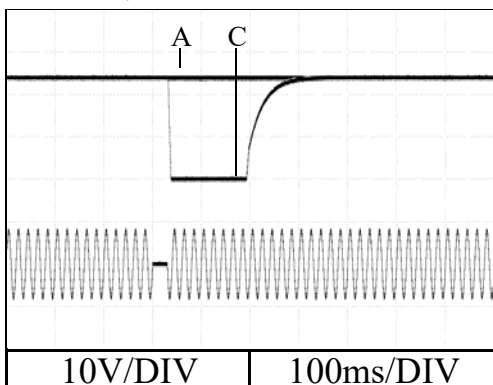

V_{in} : 200VAC

A = 31ms, C = 32ms

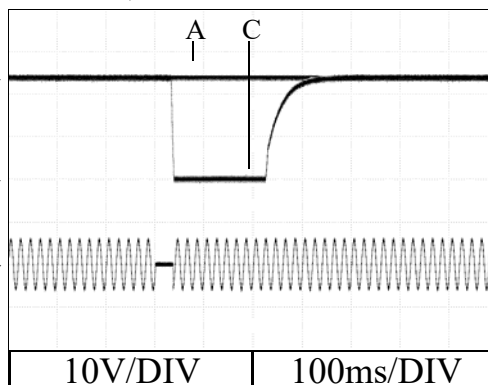

2.10 入力サージ電流 (突入電流) 波形
Inrush current waveform

24V

Conditions Vin : 100 VAC
Iout : Full load
Ta : 25 °C

Switch on phase angle of input AC voltage
 $\phi = 0^\circ$

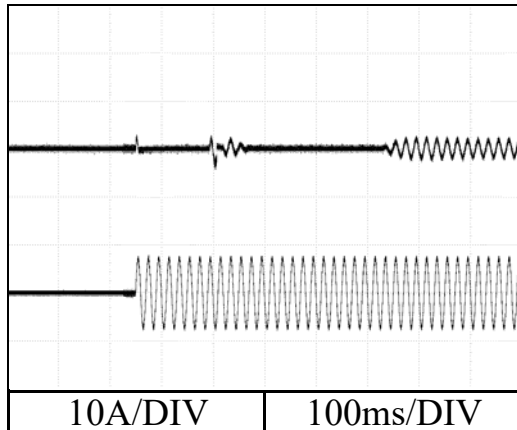

Switch on phase angle of input AC voltage
 $\phi = 90^\circ$

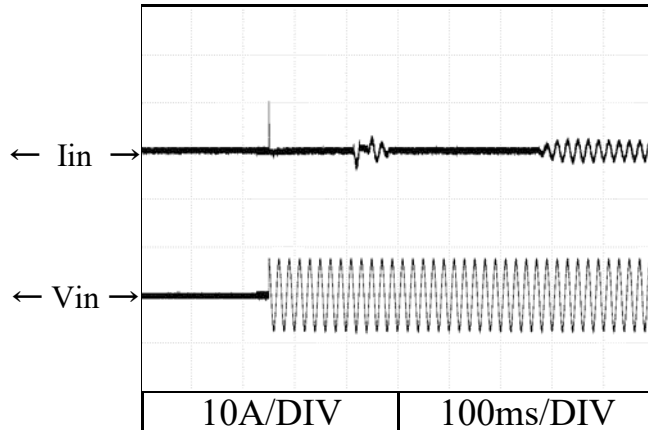

Conditions Vin : 200 VAC
Iout : Full load
Ta : 25 °C

Switch on phase angle of input AC voltage
 $\phi = 0^\circ$

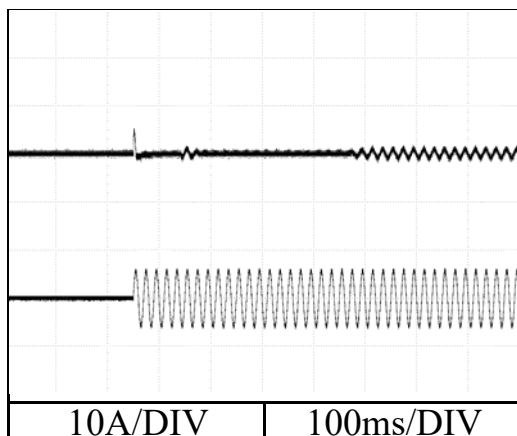

Switch on phase angle of input AC voltage
 $\phi = 90^\circ$

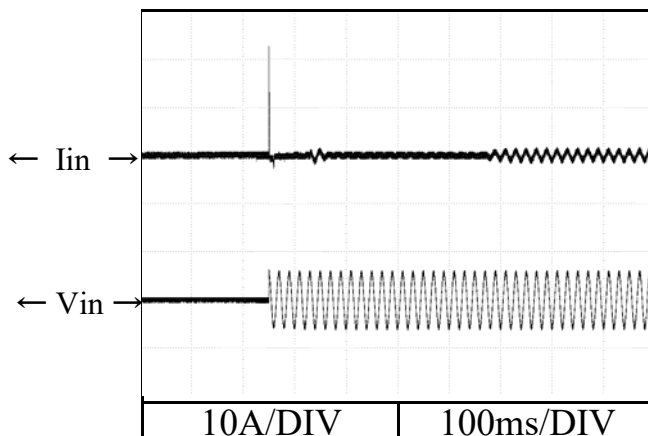

2.11 高調波成分

Input current harmonics

Conditions Iout : Full load

Ta : 25 °C

5V

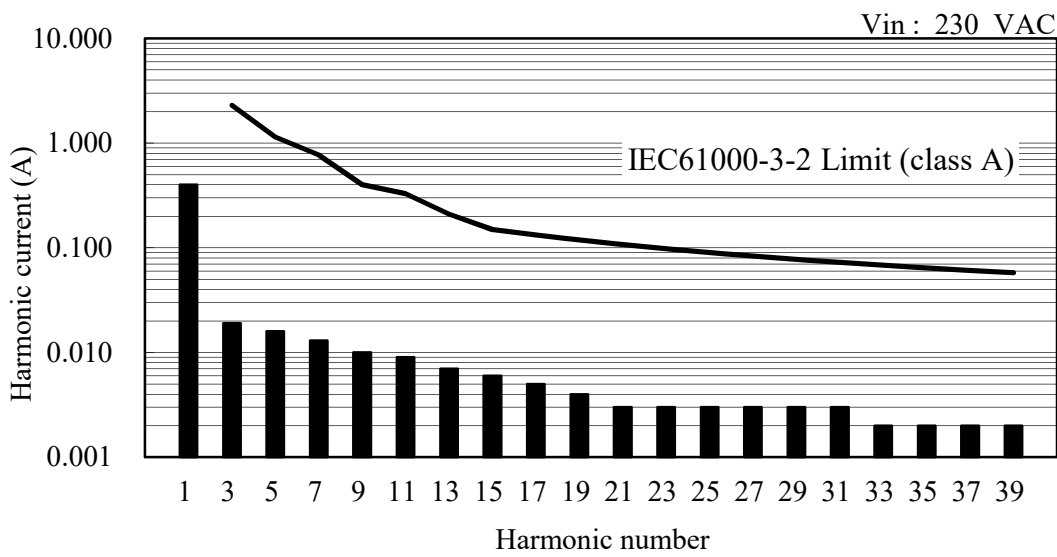
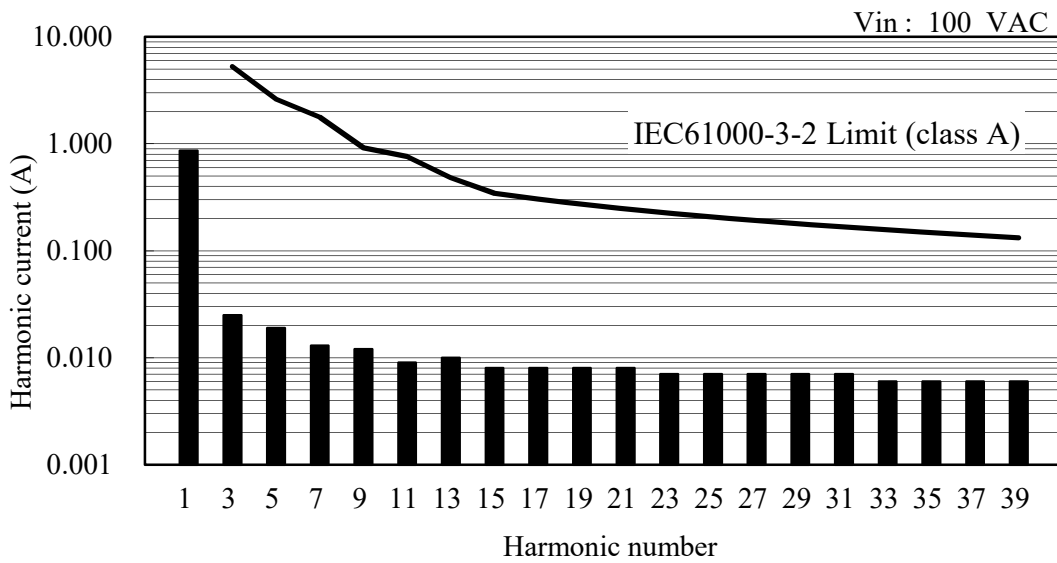

2.12 入力電流波形

Input current waveform

Conditions Iout : Full load

Ta : 25 °C

5V

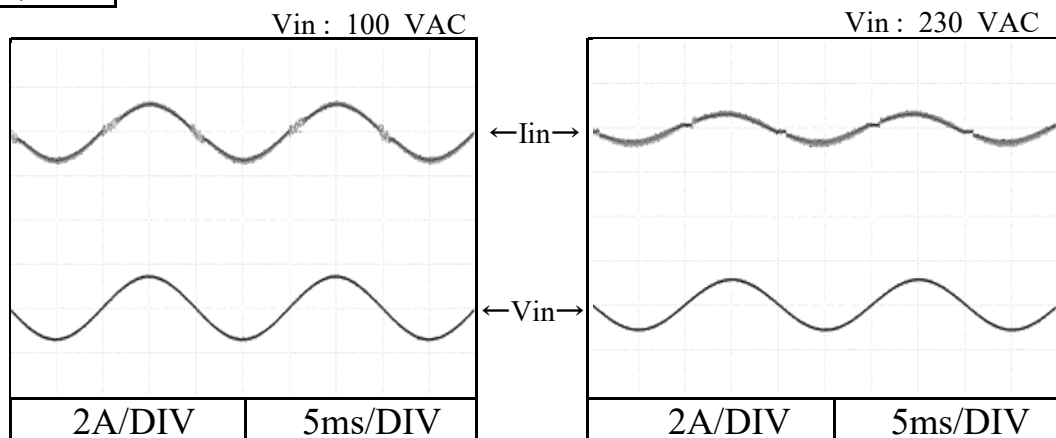

2.13 リーク電流特性
Leakage current characteristics

Conditions Iout : 0 % - - - -
 Full Load - - - -
 Ta : 25 °C
Equipment used : MODEL 228
 (Simpson)

5V

f: 50 Hz

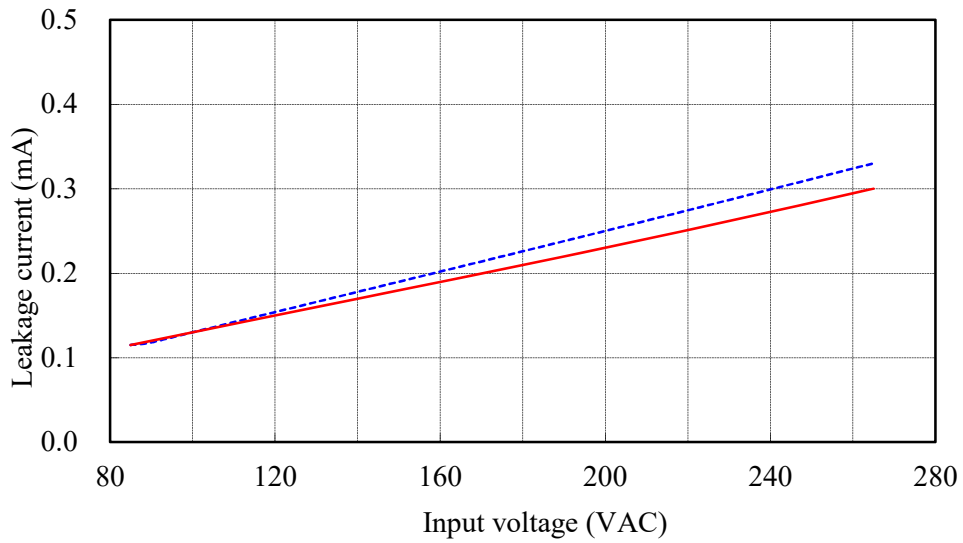

f: 60 Hz

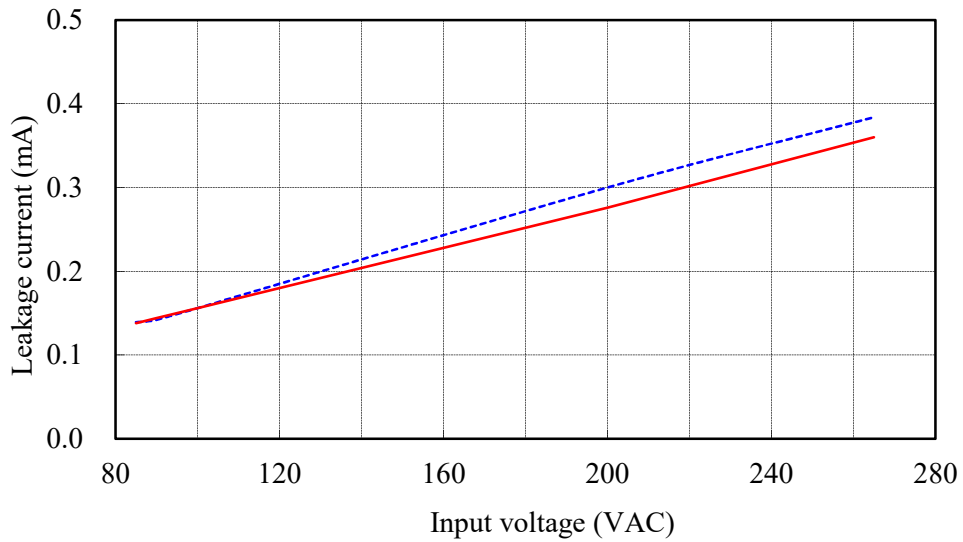

2.14 出力リップル、ノイズ波形
Output ripple and noise waveform

Conditions Vin : 110 VAC
Iout : Full load
Ta : 25 °C

5V

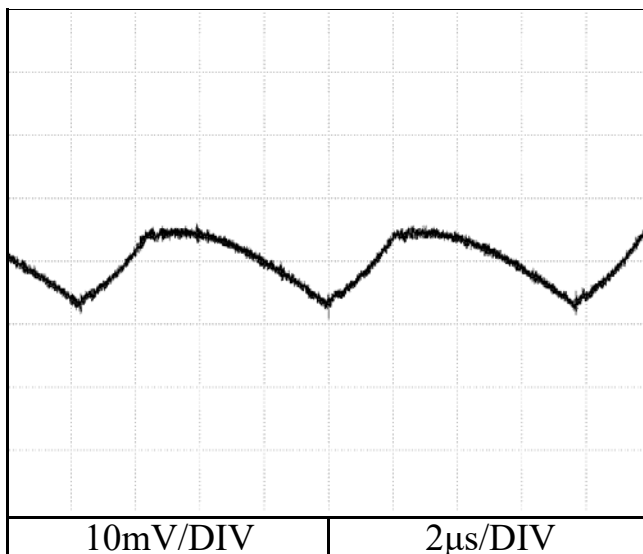

12V

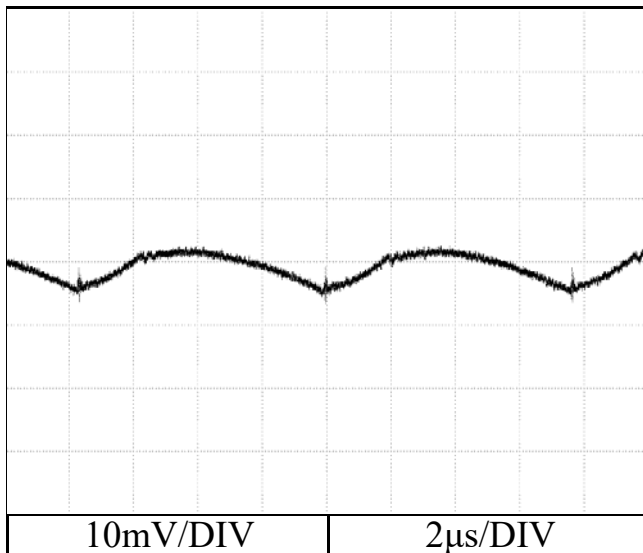

24V

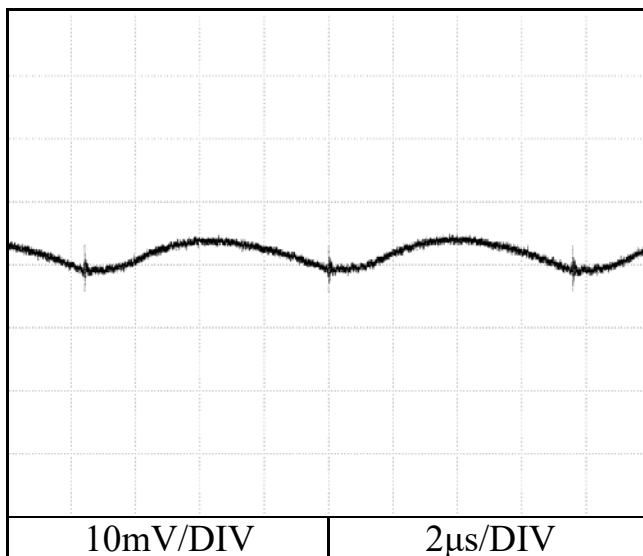

2.15 EMI 特性

Electro-Magnetic Interference characteristics

Conditions Vin : 230 VAC

Iout : Full load

Ta : 25 °C

雑音端子電圧

Conducted Emission

5V

Phase : N

Point A (664kHz)		
Ref. Data	Limit (dBuV)	Measure (dBuV)
QP	56.0	39.5
AV	46.0	39.5

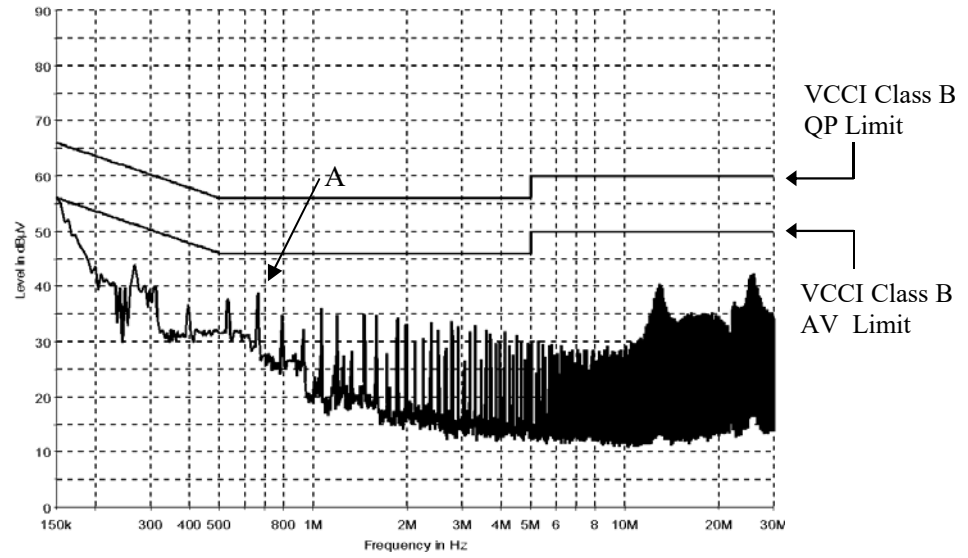

Phase : L

Point B (664kHz)		
Ref. Data	Limit (dBuV)	Measure (dBuV)
QP	56.0	40.1
AV	46.0	40.0

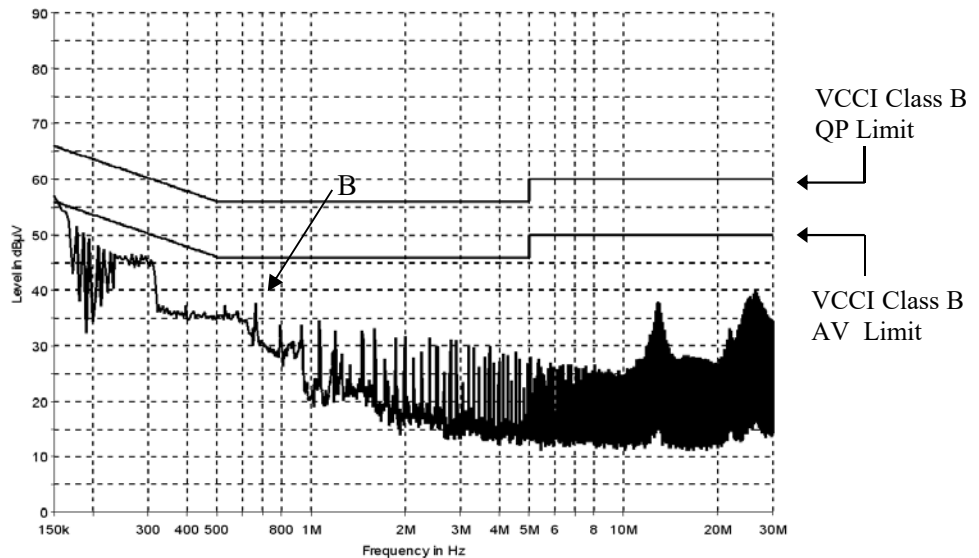

EN55011-B,EN55032-B,FCC-Bの限界値はVCCI class Bの限界値と同じ
Limit of EN55011-B,EN55032-B,FCC-B are same as its VCCI class B.

2.15 EMI 特性

Electro-Magnetic Interference characteristics

Conditions Vin : 230 VAC

Iout : Full load

Ta : 25 °C

雑音端子電圧

Conducted Emission

12V

Phase : N

Point A (150kHz)		
Ref. Data	Limit (dBuV)	Measure (dBuV)
QP	66.0	54.5
AV	56.0	32.1

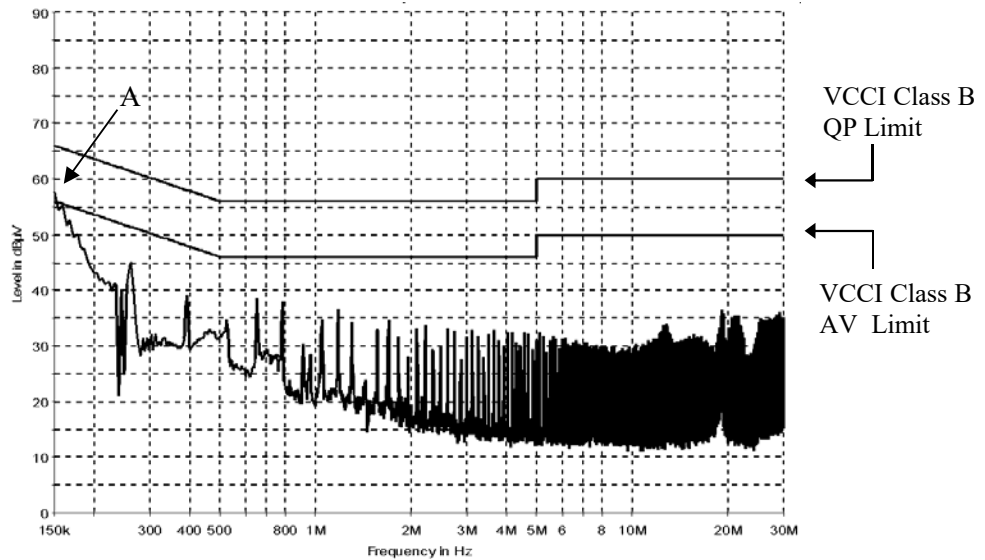

Phase : L

Point B (150kHz)		
Ref. Data	Limit (dBuV)	Measure (dBuV)
QP	66.0	54.8
AV	56.0	32.1

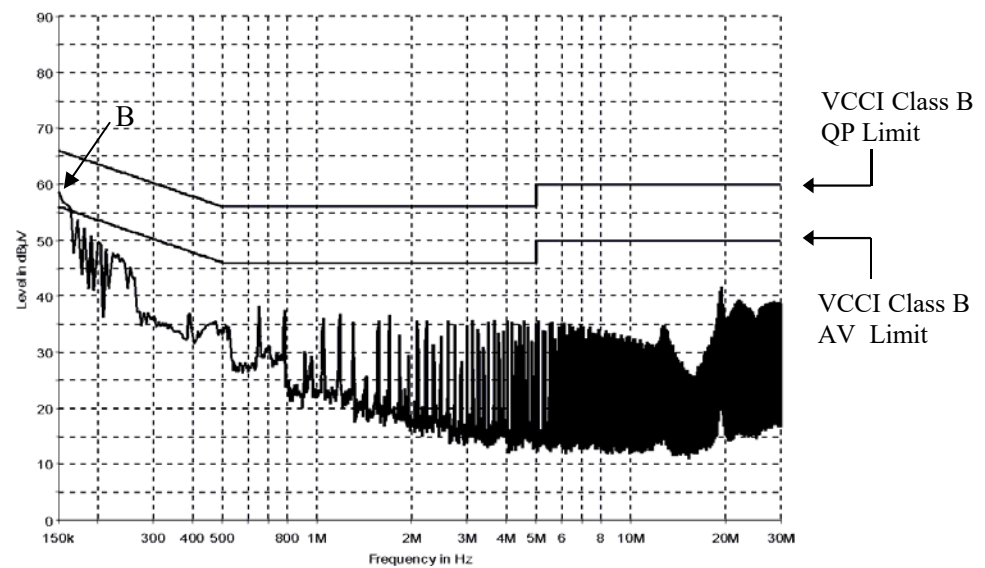

EN55011-B,EN55032-B,FCC-Bの限界値はVCCI class Bの限界値と同じ
Limit of EN55011-B,EN55032-B,FCC-B are same as its VCCI class B.

2.15 EMI 特性

Electro-Magnetic Interference characteristics

Conditions Vin : 230 VAC

Iout : Full load

Ta : 25 °C

雑音端子電圧

Conducted Emission

24V

Phase : N

Point A (150kHz)		
Ref. Data	Limit (dBuV)	Measure (dBuV)
QP	66.0	54.1
AV	56.0	31.6

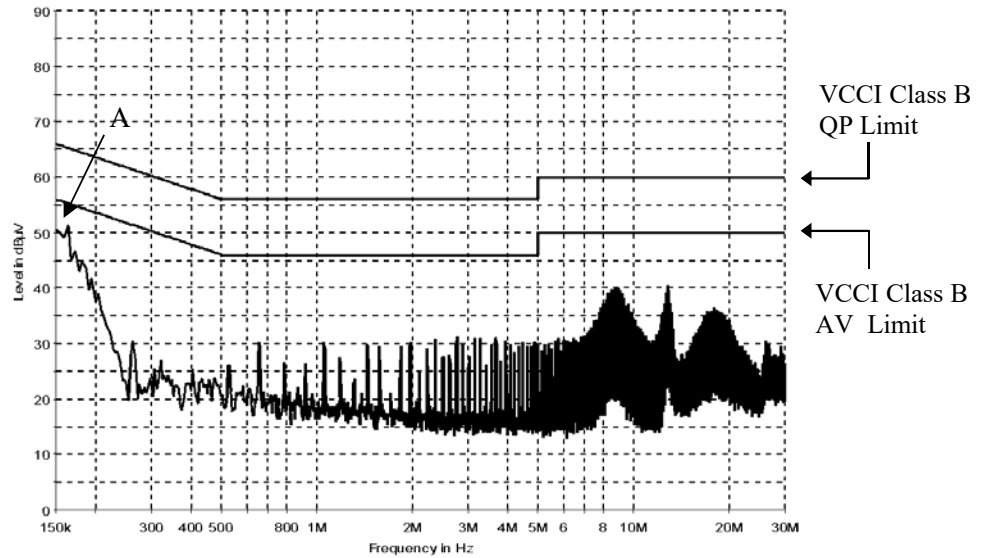

Phase : L

Point B (150kHz)		
Ref. Data	Limit (dBuV)	Measure (dBuV)
QP	66.0	54.7
AV	56.0	30.2

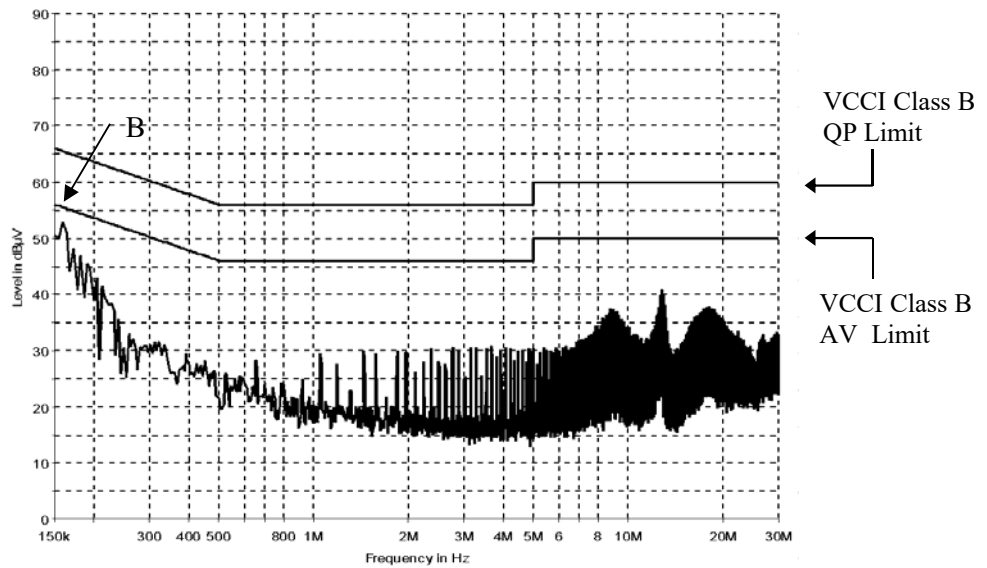

EN55011-B,EN55032-B,FCC-Bの限界値はVCCI class Bの限界値と同じ
Limit of EN55011-B,EN55032-B,FCC-B are same as its VCCI class B.

2.15 EMI 特性

Electro-Magnetic Interference characteristics

Conditions V_{in} : 230 VAC

I_o : Full load

T_a : 25 °C

雑音電界強度

Radiated Emission

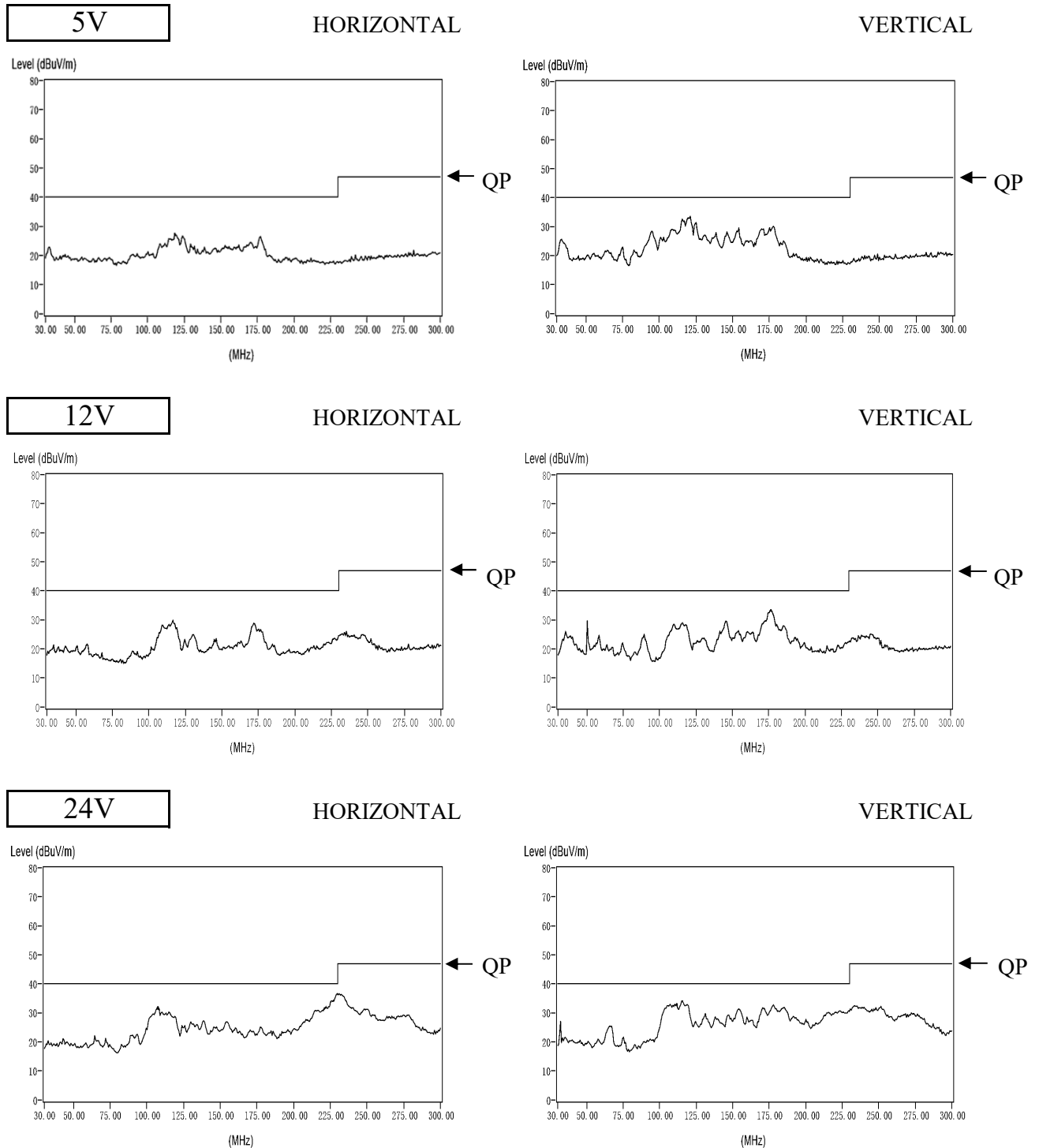

EN55011-B,EN55032-Bの限界値はVCCI class Bの限界値と同じ
Limit of EN55011-B,EN55032-B are same as its VCCI class B.

表示はピーク値
Indication is peak values.