

# ***TDK-Lambda***

## **TPS4000-12**

### **Evaluation Data**

*PRINT IN COLOR*

## INDEX

Load/Line Regulation .....	4
Temperature Drift .....	4
Efficiency vs Output Current .....	5
Power Factor vs Output Current .....	6
Inrush Characteristics .....	7
Output Rise Characteristics .....	13
AC ON Control .....	13
Remote On/Off Control .....	17
Rise Time & Overshoot .....	21
Hold-Up Time Characteristics .....	23
Ripple Characteristics .....	25
OCP Characteristics .....	29
Local Mode .....	29
Remote Mode .....	30
Conducted Emissions .....	31
Radiated Emissions .....	34
Current Share .....	36

## TERMINOLOGY USED

- $V_{out}$  = Output Voltage
- $I_{out}$  = Output Current
- $V_{in}$  = Input Voltage
- $I_{in}$  = Input Current
- $I_{lim}$  = Current Limit
- $T_a$  = Ambient Temperature
- OVP = Over-voltage protection
- OCP – Over-current protection

### Load/Line Regulation

Vout = 12Vdc, 100% load = 167A, Ta = 25°C

Vout adjusted with trim Pot (V<sub>out ADJ</sub>) and measured across output bus bars. Remote sense connected to bus bars.

Iout\Vin	350VAC	400VAC	480VAC	528VAC	Line Regulation	
0% Load	12.027	12.028	12.023	12.023	0.005	0.041%
12.5% Load	12.030	12.025	12.025	12.031	0.006	0.050%
25.0% Load	12.025	12.030	12.030	12.031	0.006	0.050%
37.5% Load	12.030	12.030	12.025	12.026	0.005	0.041%
50.0% Load	12.029	12.025	12.025	12.030	0.005	0.041%
62.5% Load	12.024	12.024	12.029	12.030	0.006	0.050%
75.0% Load	12.028	12.028	12.024	12.024	0.004	0.033%
87.5% Load	12.027	12.023	12.023	12.028	0.005	0.041%
100% Load	12.021	12.022	12.027	12.027	0.006	0.050%
Load Regulation	0.009	0.008	0.007	0.008		
	0.075%	0.066%	0.058%	0.066%		

**Note 1:** If Vout programming with PMBus, settings are not stored after Input AC source power cycling.

### Temperature Drift

Vout = 12Vdc, 100% load = 167A

Vin (VAC)	Iout (%)	Vout @ -40°C	Vout @ 25°C	Vout @ 50°C	Vout Delta	Overall Temperature Coefficient (ppm)
400	100%	12.036	12.022	12.029	0.007	23.29
480	100%	12.043	12.027	12.023	0.016	20.47
400	0%	12.040	12.028	12.031	0.012	15.35
480	0%	12.037	12.023	12.025	0.014	17.91

## Efficiency vs Output Current

Vout = 12Vdc, 100% Load = 167A, Ta = 25°C

Iout(%) / Vin	350 VAC	400 VAC	480 VAC	528 VAC
12.5% Load	74.07%	74.74%	74.97%	75.19%
25.0% Load	84.29%	85.13%	85.44%	85.66%
37.5% Load	87.42%	87.69%	88.12%	88.34%
50.0% Load	88.67%	88.86%	89.16%	89.33%
62.5% Load	89.07%	89.29%	89.37%	89.61%
75.0% Load	89.10%	89.30%	89.34%	89.40%
87.5% Load	88.82%	88.97%	89.08%	89.17%
100.0% Load	88.32%	88.52%	88.66%	88.71%

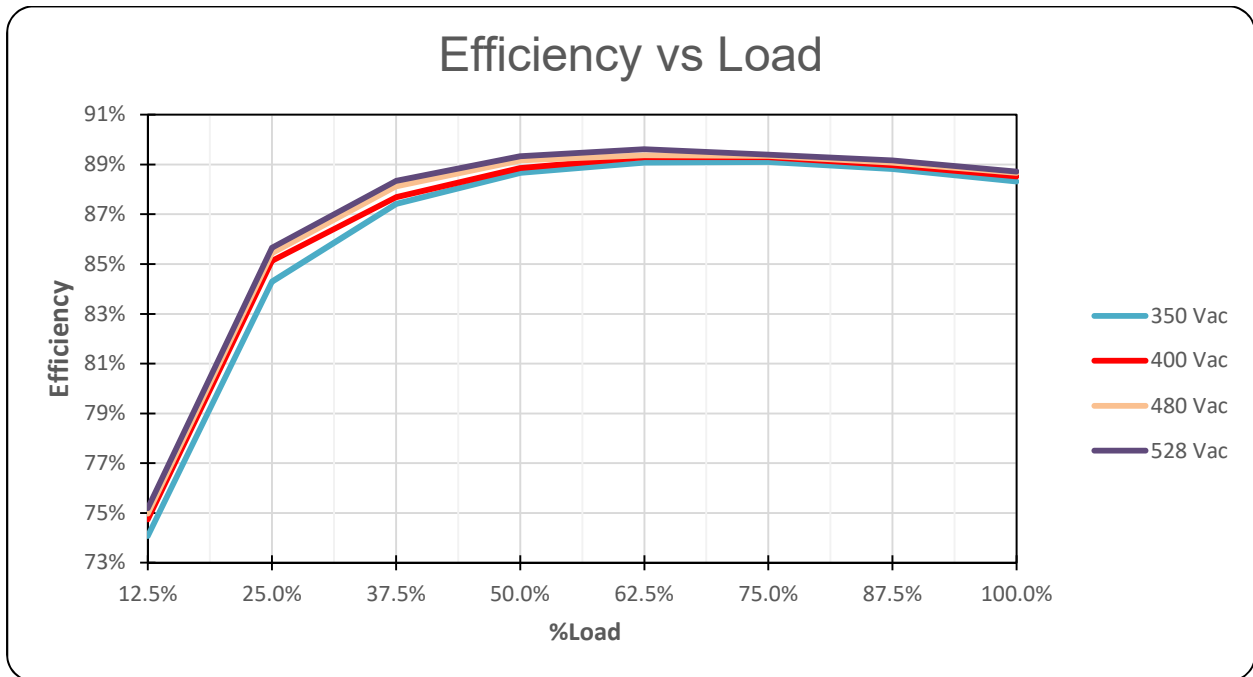

### Power Factor vs Output Current

Vout = 12Vdc, 100% Load = 167A, Ta = 25°C

Iout(%) / Vin	350 VAC	400 VAC	480 VAC	528 VAC
12.5% Load	0.6935	0.5714	0.4750	0.4337
25.0% Load	0.8163	0.7151	0.5807	0.5388
37.5% Load	0.8653	0.8100	0.6841	0.6205
50.0% Load	0.8928	0.8571	0.7428	0.6800
62.5% Load	0.9081	0.8873	0.7772	0.7091
75.0% Load	0.9174	0.9069	0.8291	0.7379
87.5% Load	0.9234	0.9194	0.8714	0.8116
100.0% Load	0.9275	0.9276	0.8949	0.8615

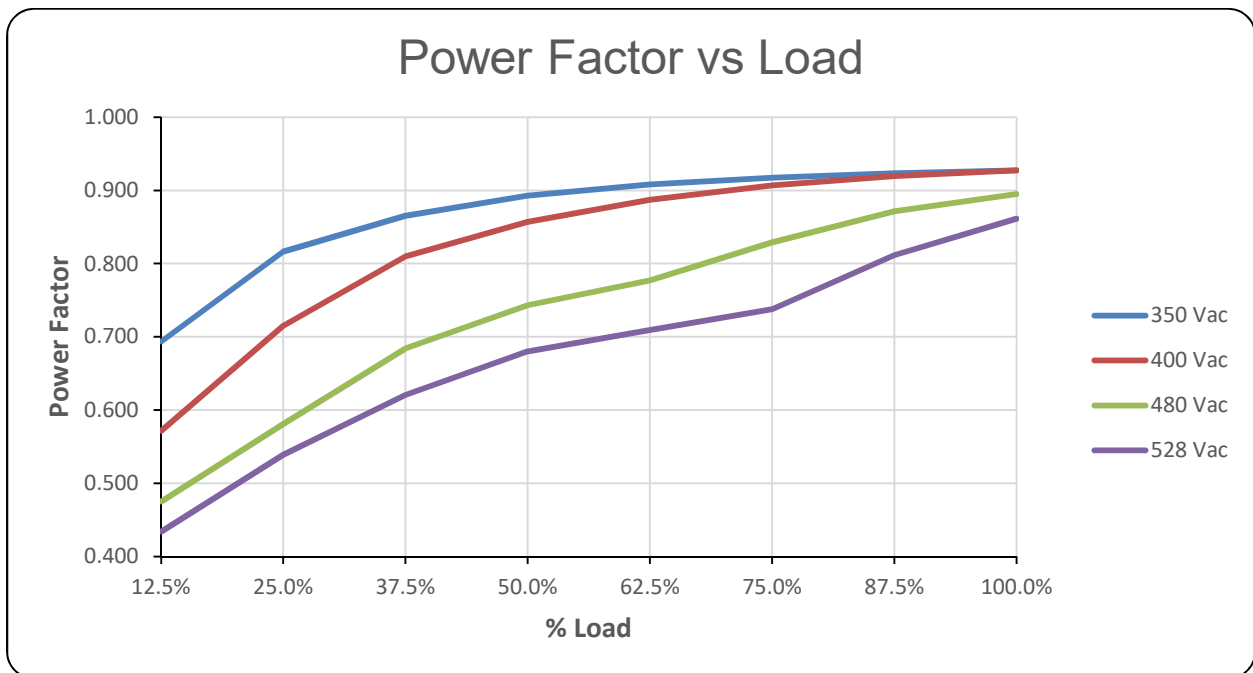

### Inrush Characteristics

Inrush Current <25A peak per phase @ 400-480VAC input (excluding initial spike charging capacitors lasting < 2ms)

Vout =12Vdc, Ta=25°C, %100 Load = 167A

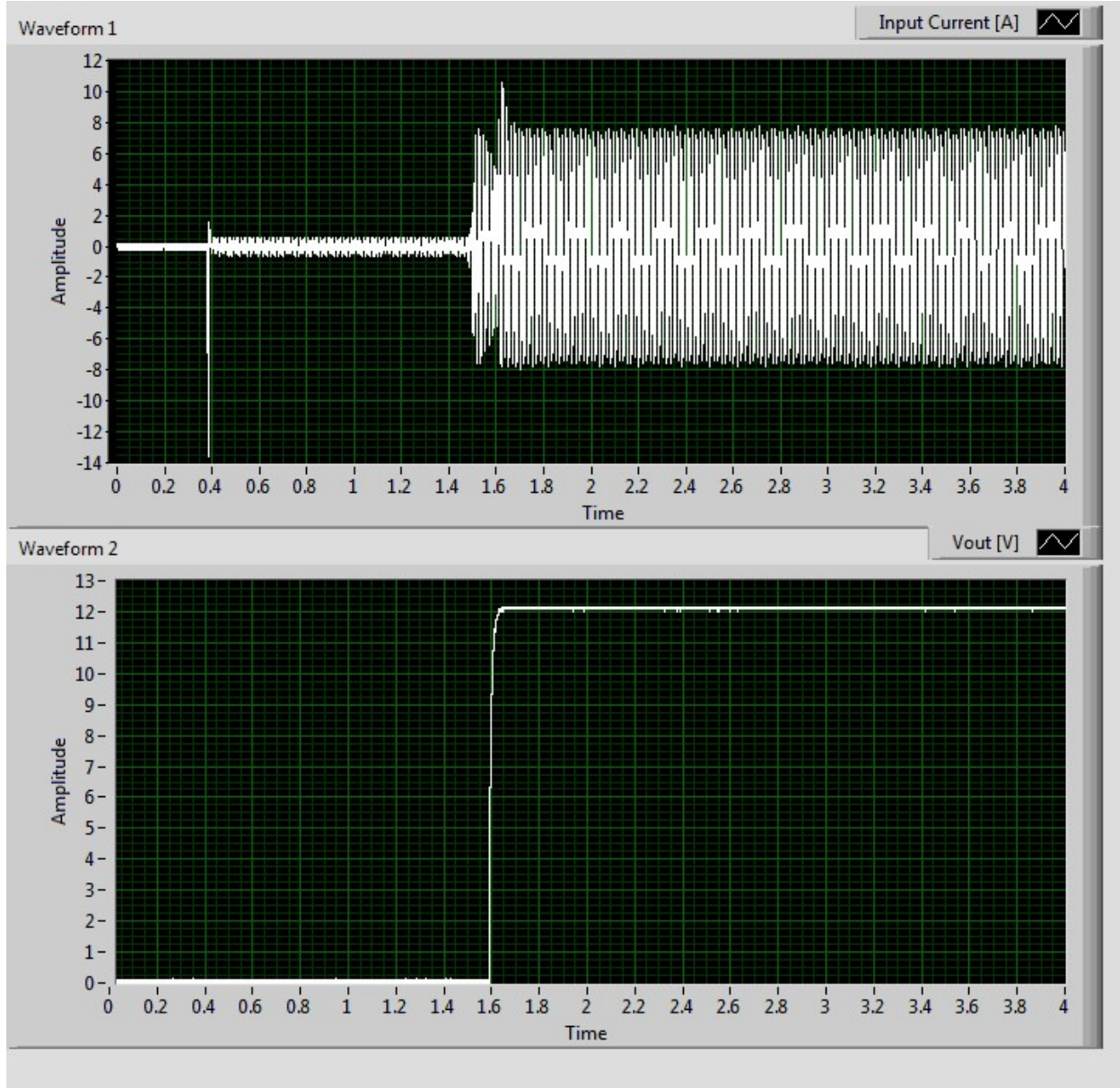

Figure 1: Inrush @ 400VAC, 100% Load

WAVEFORM 1 – Inrush Current, 2A/DIV

WAVEFORM 2 – Vout, 1V/DIV

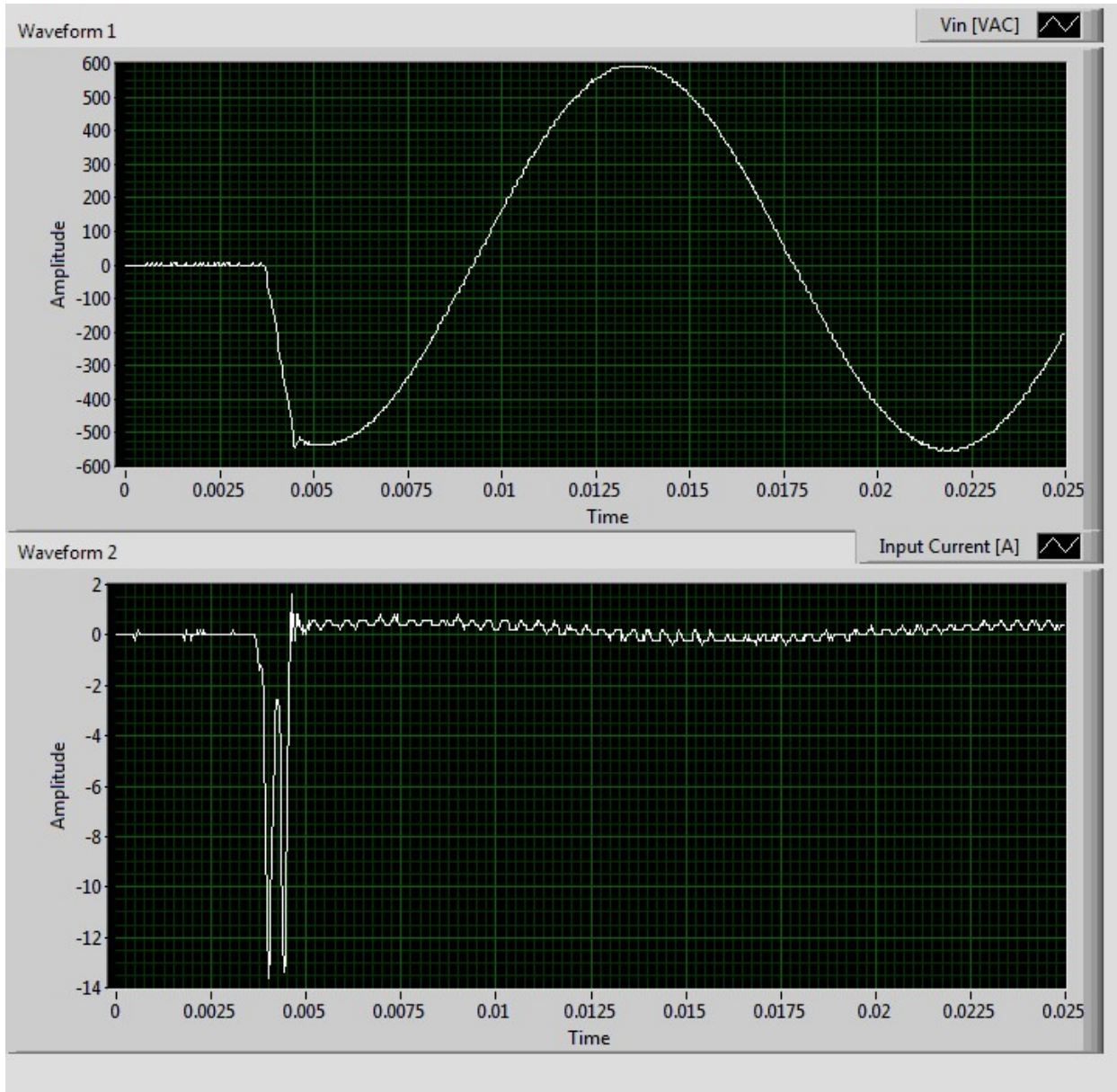

Figure 2: Inrush @ 400VAC, 100% Load. Initial spike charging capacitors  
WAVEFORM 1 – Vin, 100V/DIV  
WAVEFORM 2 – Inrush Current, 2A/DIV



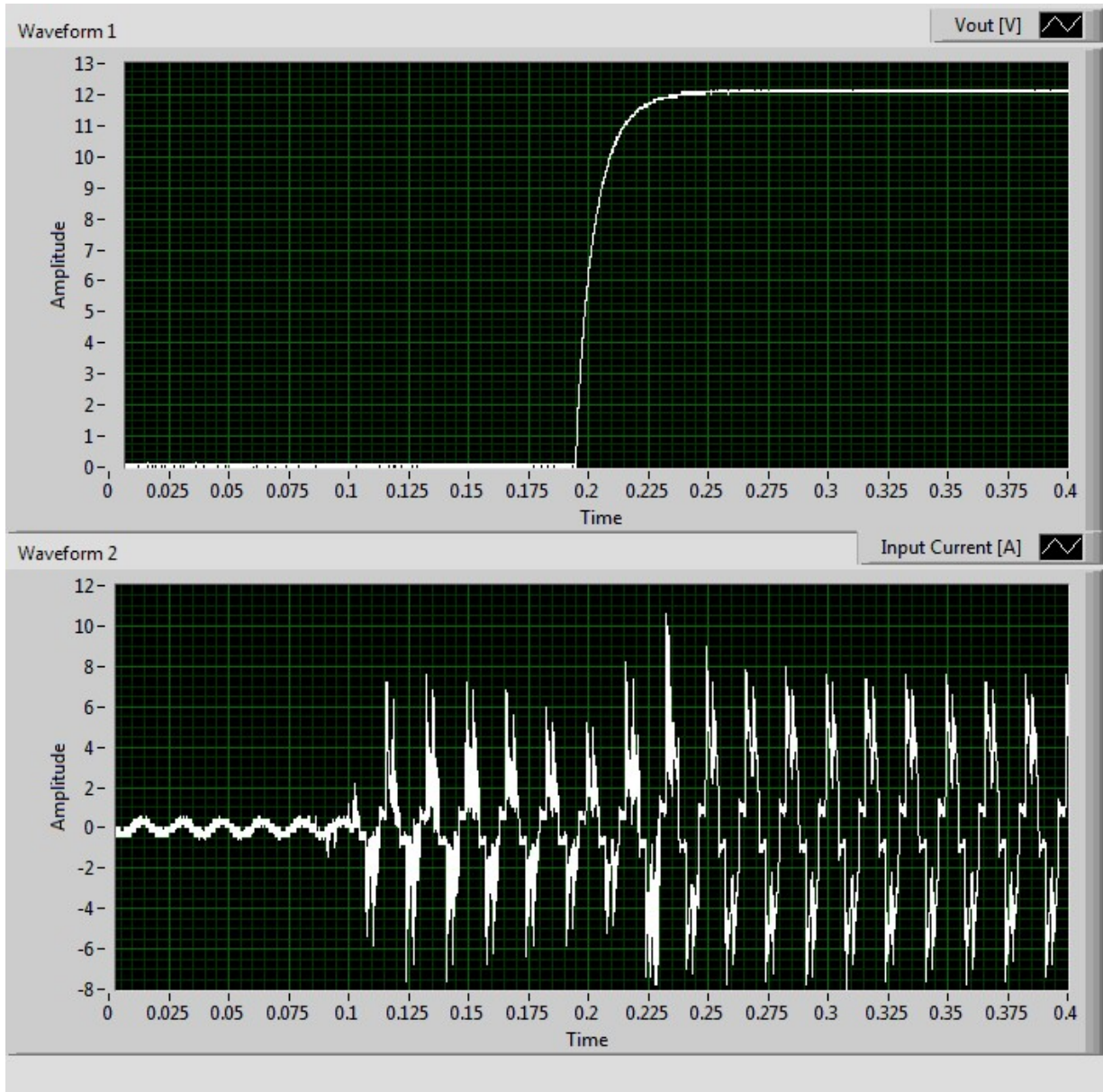

Figure 3: Inrush @ 400VAC, 100% Load.

WAVEFORM 1 – Vout, 1V/DIV

WAVEFORM 2 – Inrush Current, 2A/DIV

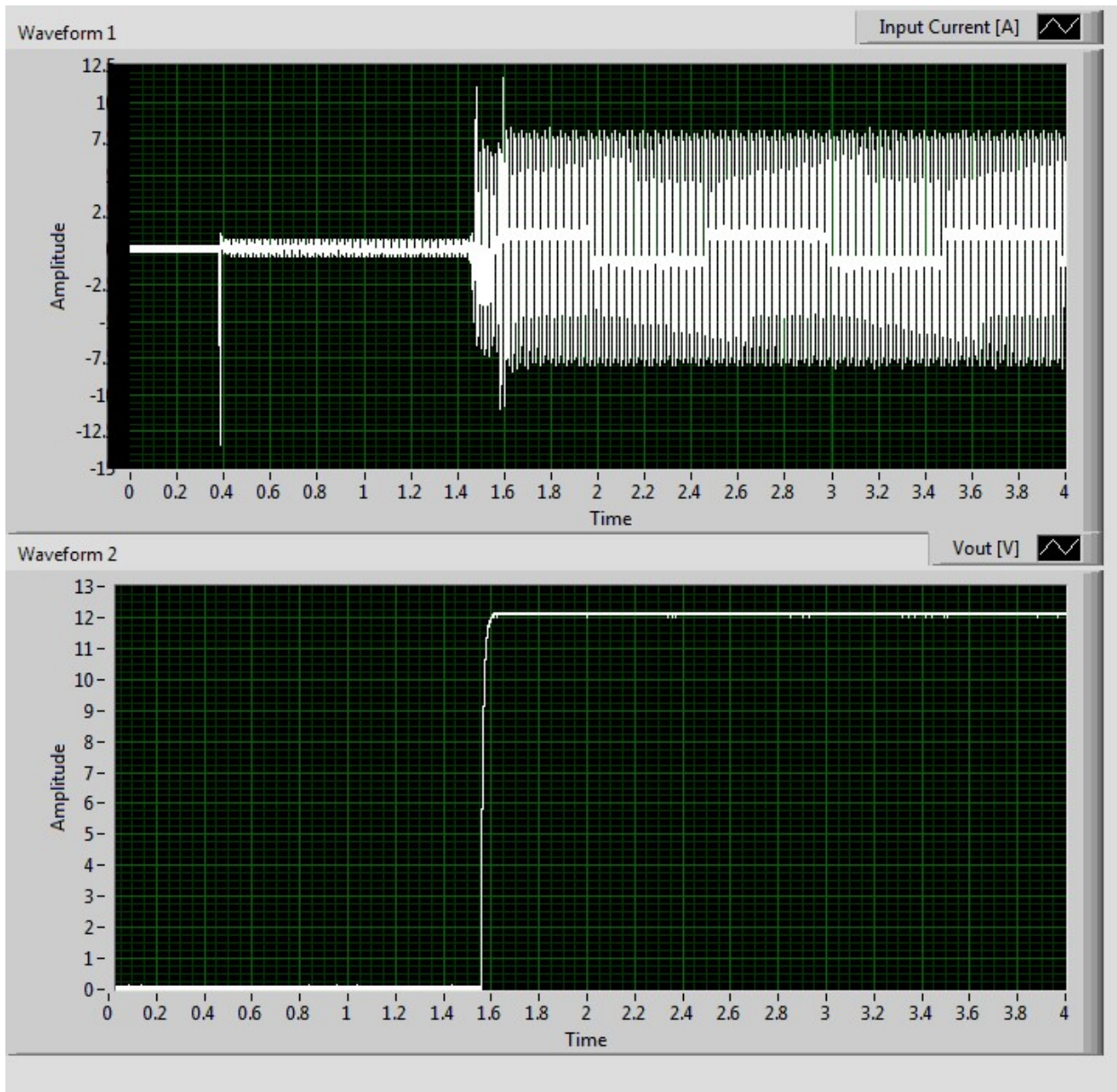

Figure 4: Inrush @ 480VAC, 100% Load

WAVEFORM 1 – Inrush Current, 2.5A/DIV

WAVEFORM 2 – Vout, 1V/DIV

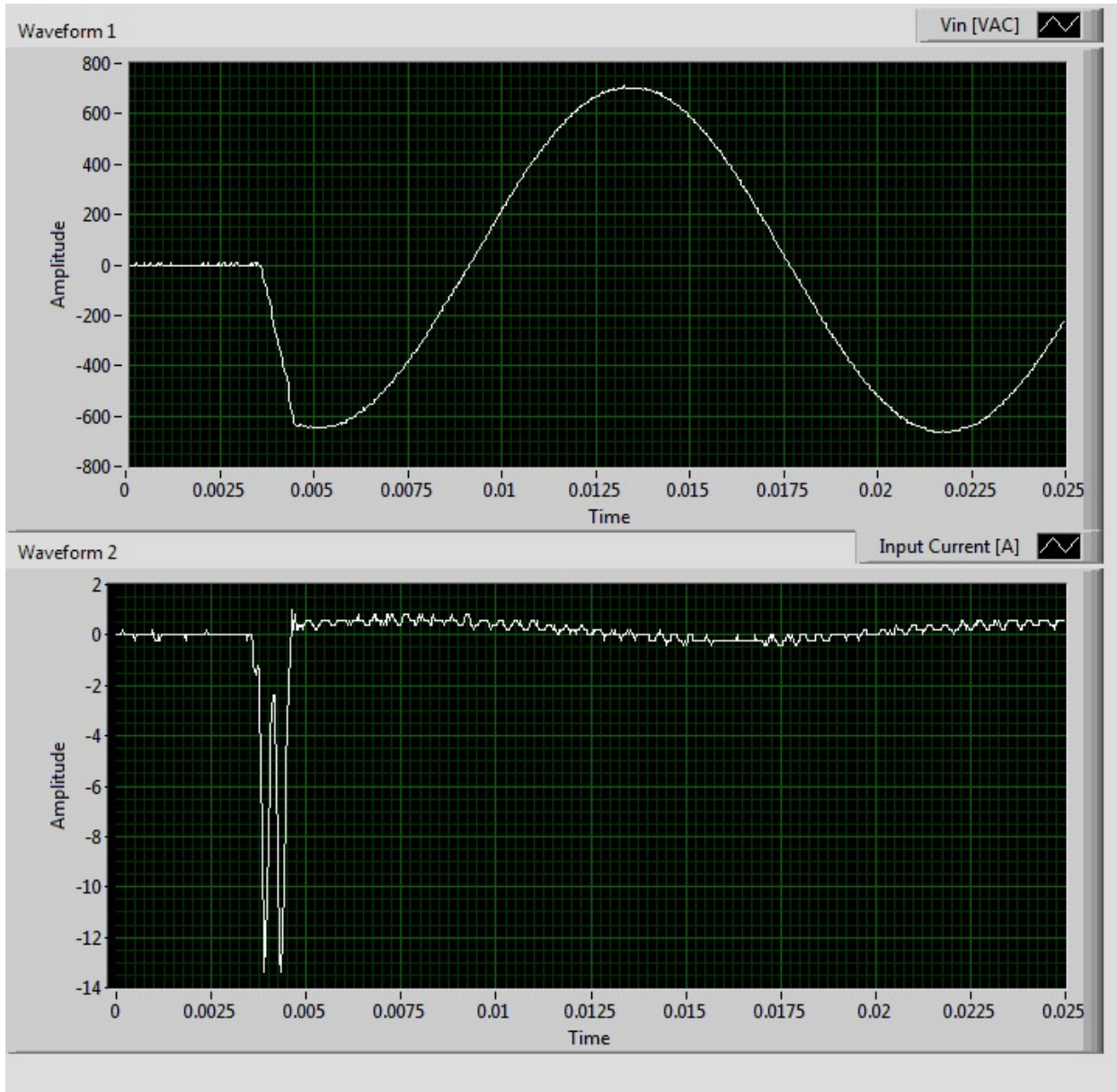

Figure 5: Inrush @ 480VAC, 100% Load. Initial spike charging capacitors  
 WAVEFORM 1 – Vin, 200V/DIV  
 WAVEFORM 2 – Inrush Current, 2A/DIV



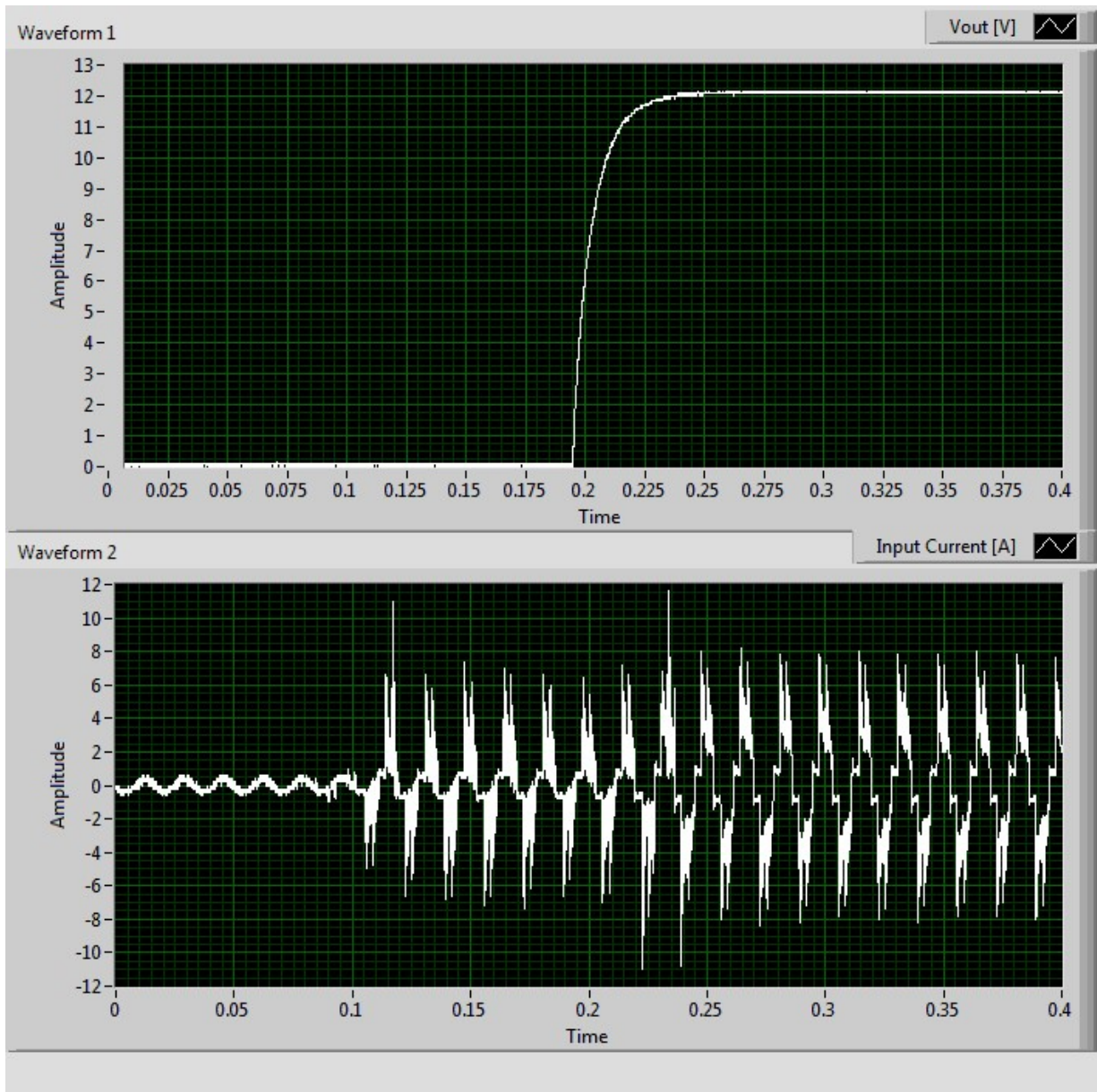

Figure 6: Inrush @ 480VAC, 100% Load.

WAVEFORM 1 – Vout, 1V/DIV

WAVEFORM 2 – Inrush Current, 2A/DIV

## Output Rise Characteristics

$V_{out} = 12V_{dc}$ ,  $T_a = 25^{\circ}C$ ,  $I_{out} = 167A$

**AC ON Control** - Output Rise time from application of input voltage

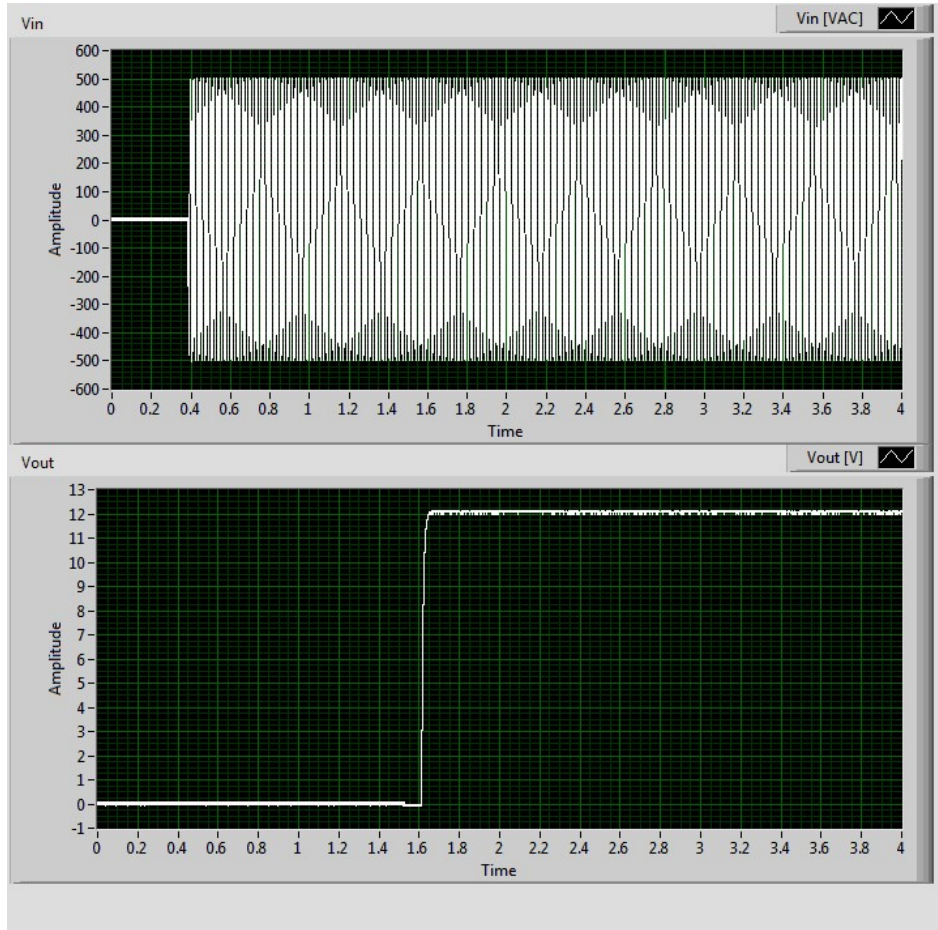

Figure 7: Turn ON Time from  $V_{in} = 350V_{AC}$ .  
(CH1:  $V_{in}$ , 100V/div; CH2:  $V_{out}$ , 1V/div)

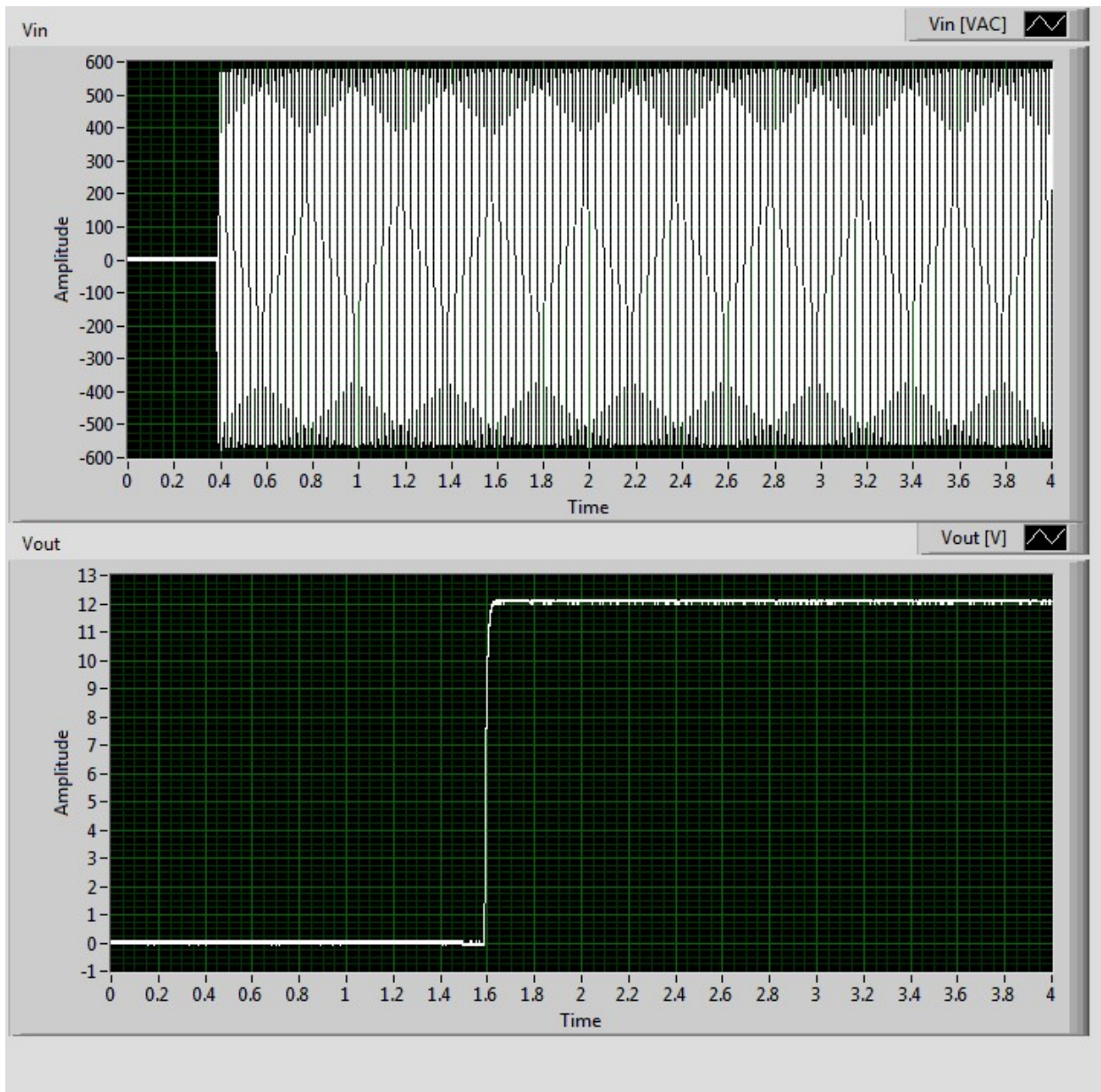

Figure 8: Turn ON Time from  $V_{in} = 400VAC$ .  
(CH1:  $V_{in}$ , 100V/div; CH2:  $V_{out}$ , 1V/div)



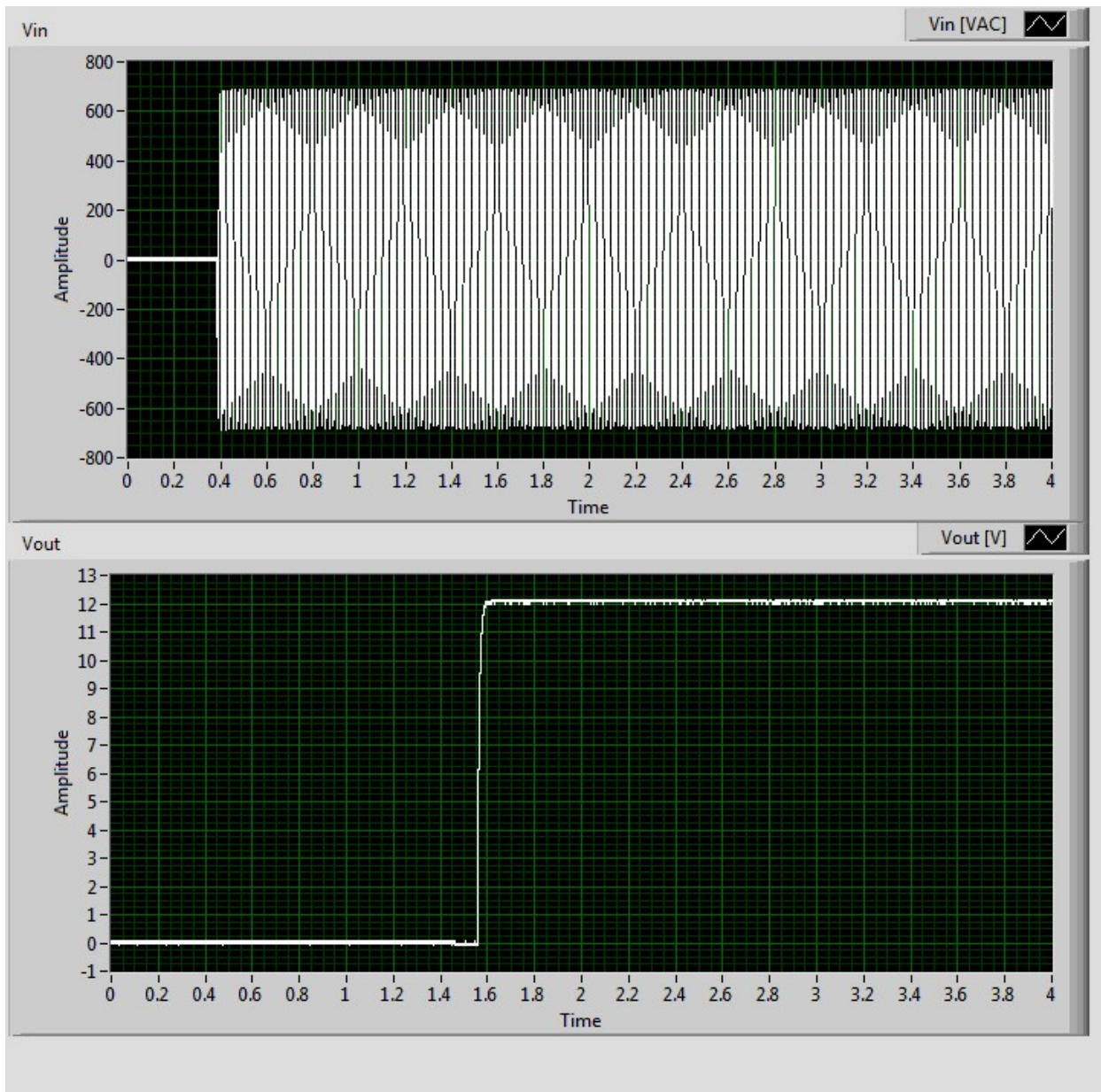

Figure 9: Turn ON Time from Vin = 480VAC.  
(CH1: Vin, 200V/div; CH2: Vout, 1V/div)

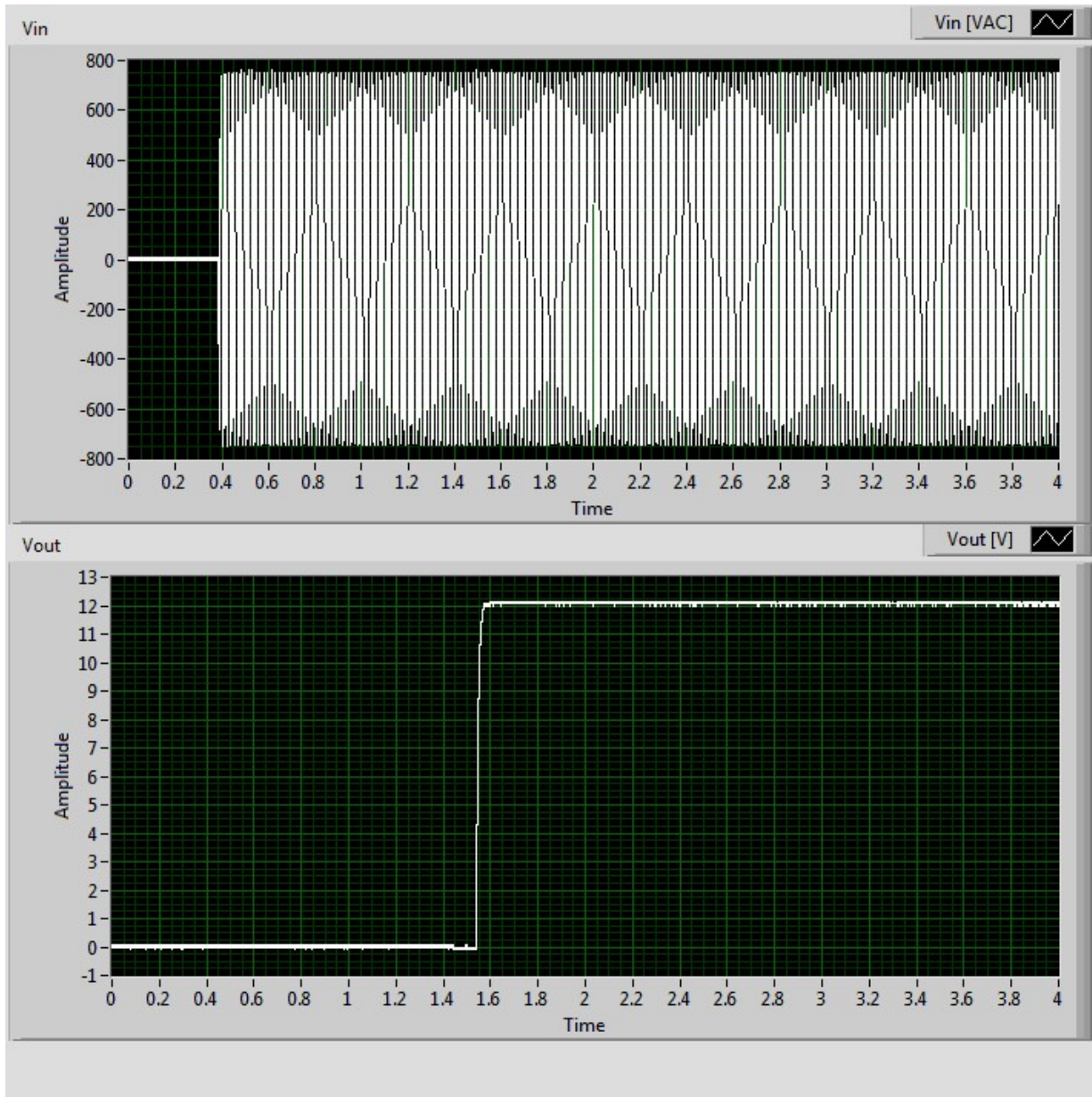

Figure 10: Turn ON Time from  $V_{in} = 528VAC$ .  
(CH1:  $V_{in}$ , 200V/div; CH2:  $V_{out}$ , 1V/div)



**Remote On/Off Control** – TTL voltage level compatible signal connected between pins 14(PSON) and 18(-SNS) of the Signal Connector. With the Output Enable switch in the ON position, a Logic High or Open will enable the output. A Logic Low or Short will disable the output.

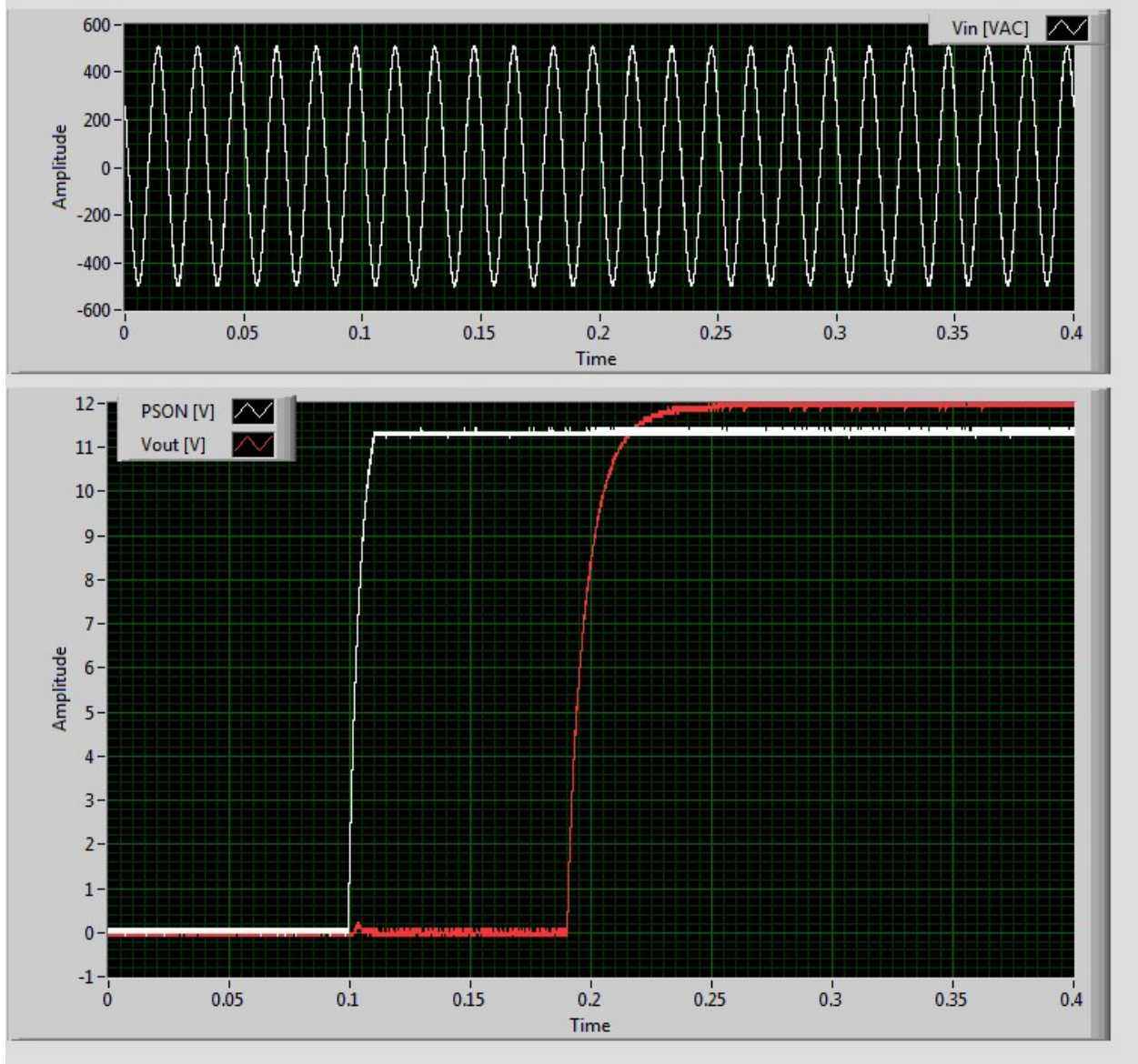

Figure 11: Rise Time from Remote On-Off 350VAC 100% load.  
(CH1:Vin,200V/div;CH2:PSON,1V/div;CH3:Vout,1V/div)

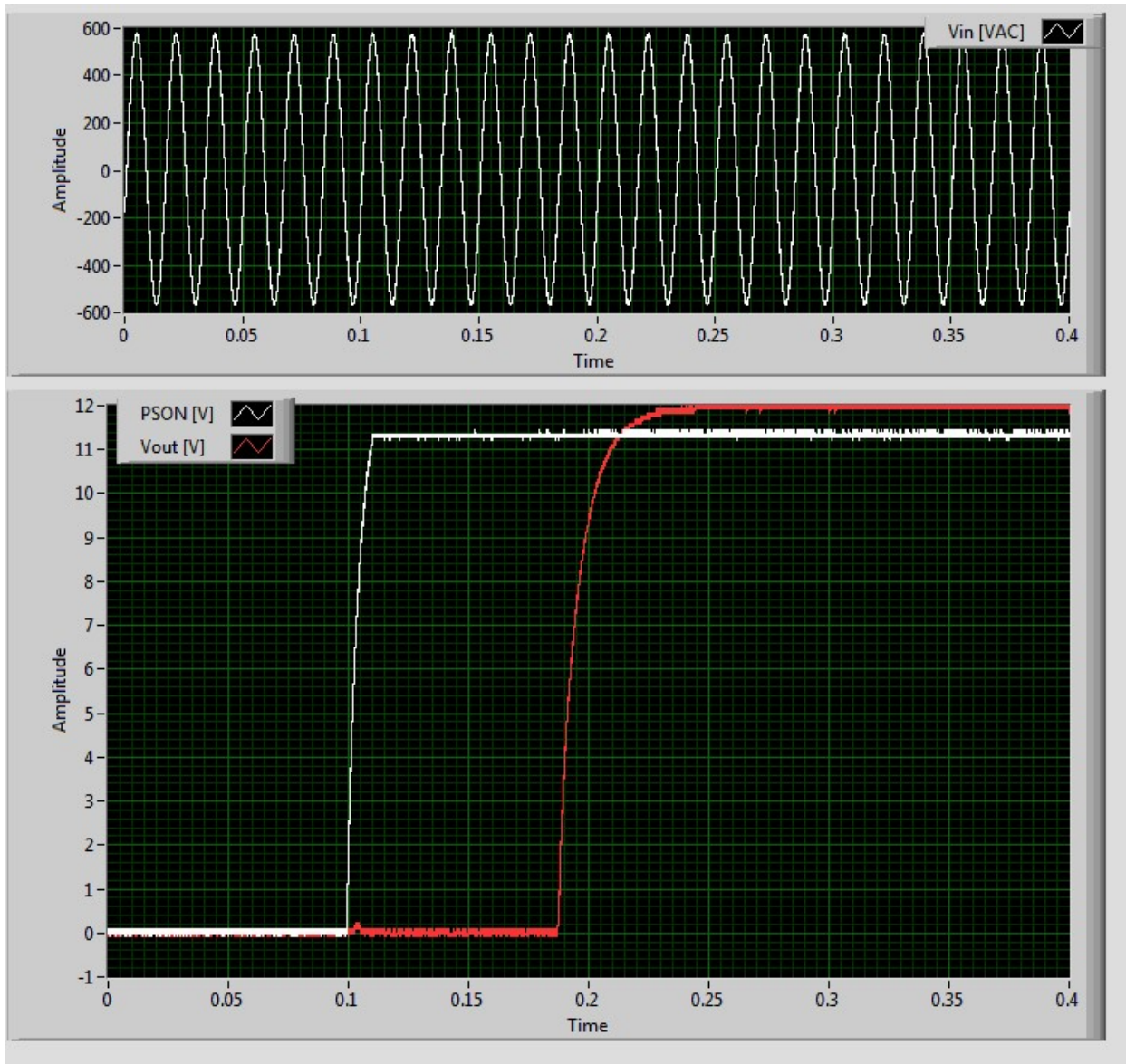

Figure 12: Rise Time from Remote On-Off 400VAC 100% load.  
 (CH1:Vin,200V/div;CH2:PSON,1V/div;CH3:Vout,1V/div)

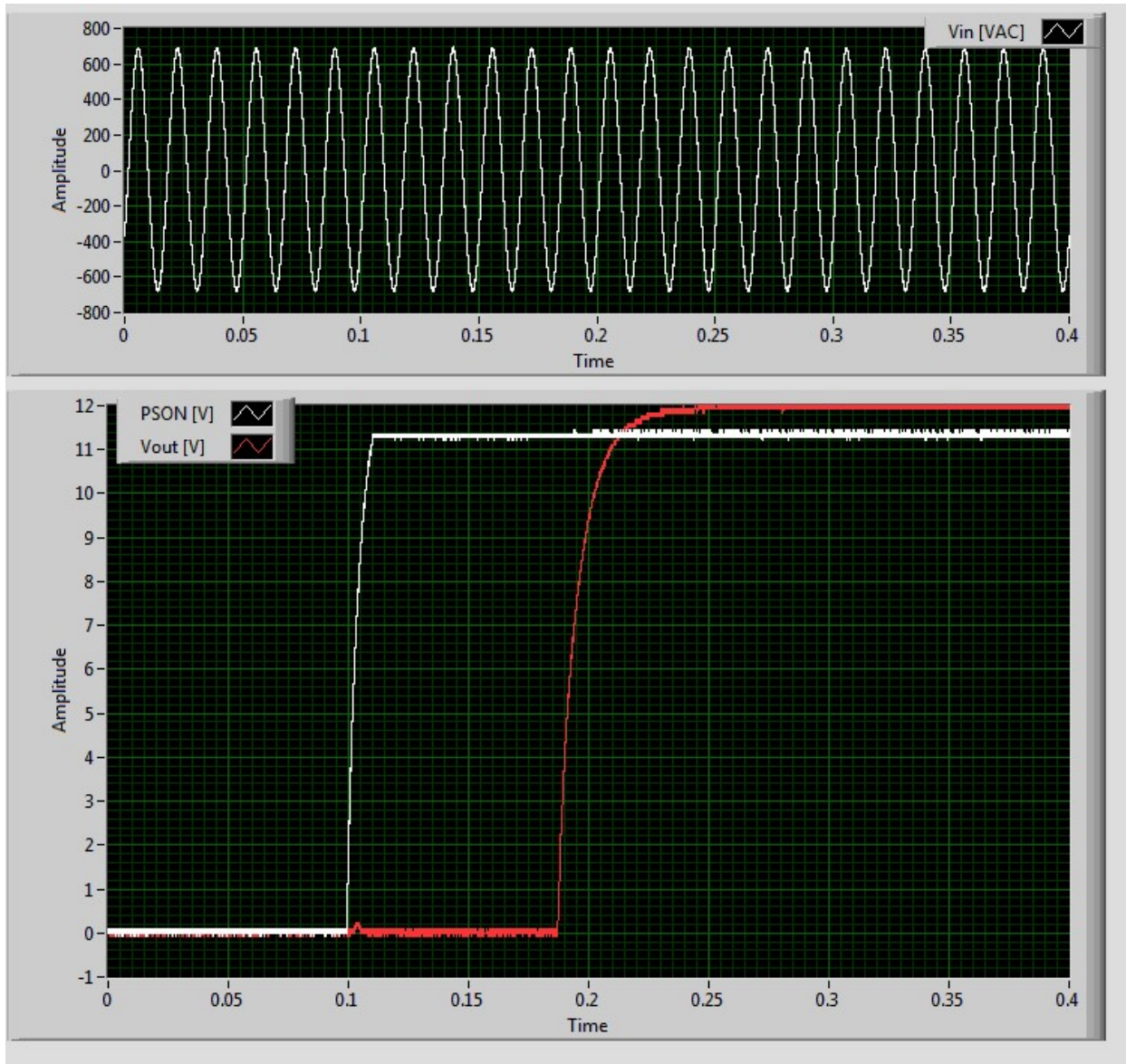

Figure 13: Rise Time from Remote On-Off 480VAC 100% load.  
 (CH1:Vin,200V/div;CH2:PSON,1V/div;CH3:Vout,1V/div)



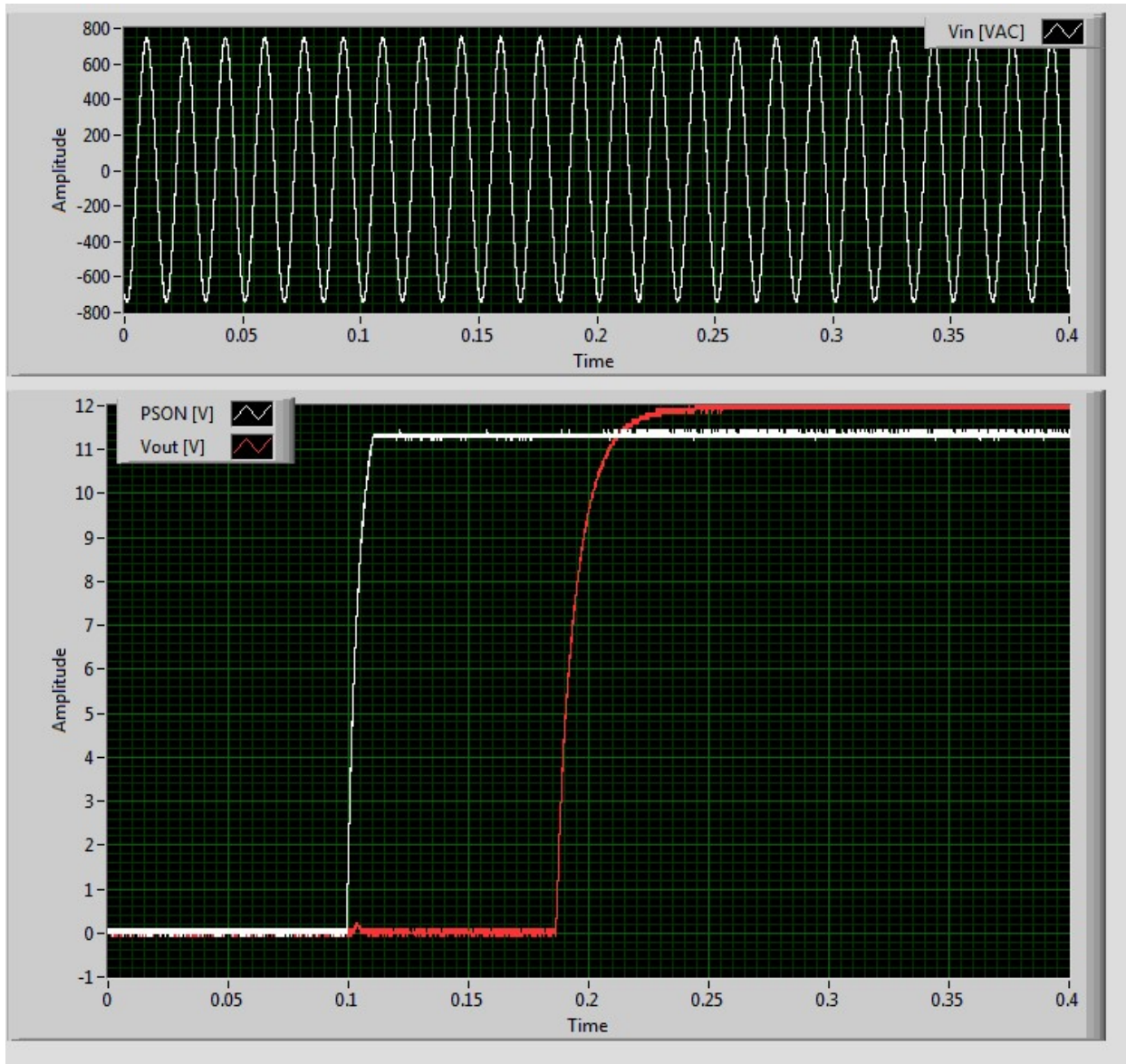

Figure 14: Rise Time from Remote On-Off 528VAC 100% load.  
 (CH1:Vin,200V/div;CH2:PSON,1V/div;CH3:Vout,1V/div)

### Rise Time & Overshoot

Vout = 12Vdc, 100% Load = 167A, Ta = 25°C

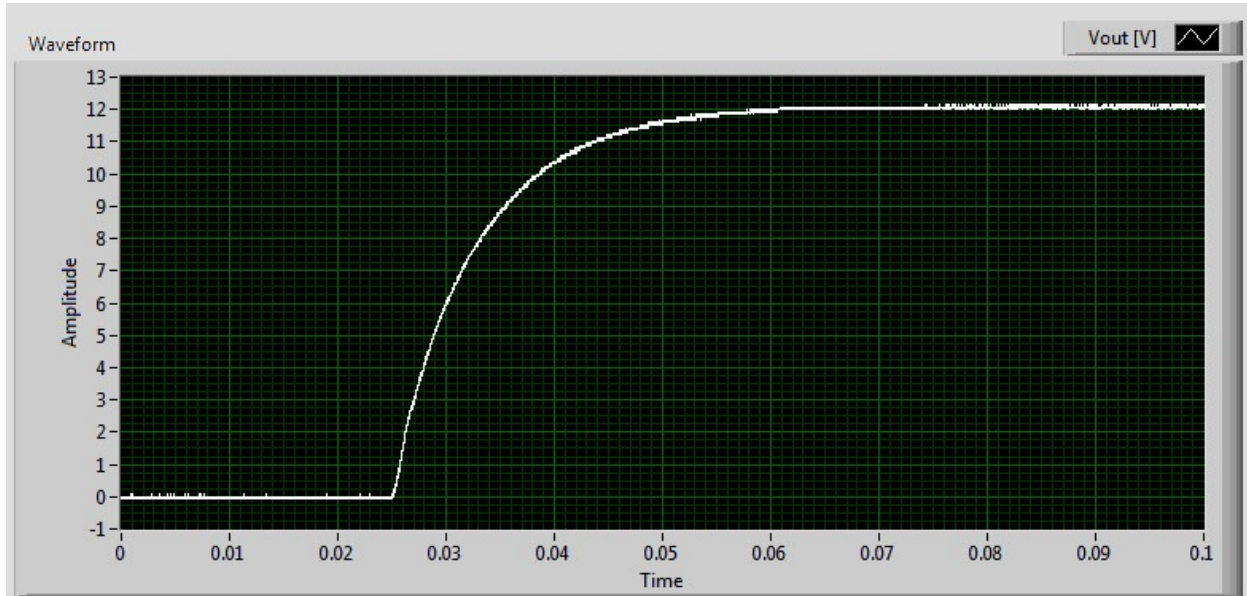

Figure 15: Rise Characteristics at Turn On 350VAC 0% load (CH1: Vout, 1V/div).

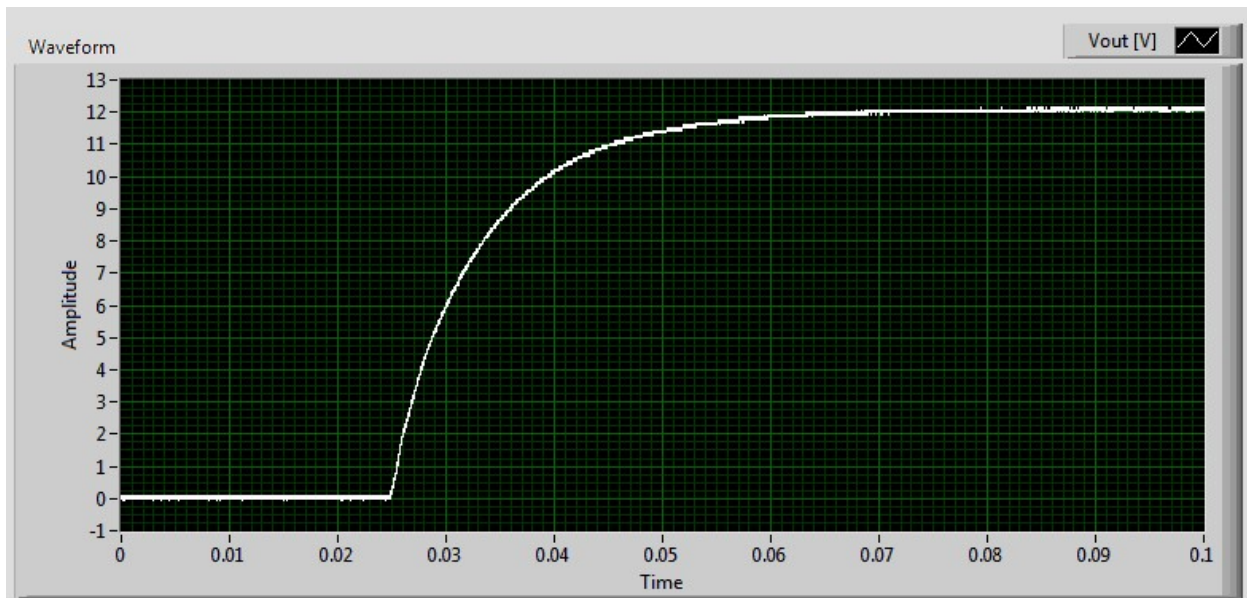

Figure 16: Rise Characteristics at Turn On 350VAC 100% load (CH1: Vout, 1V/div)

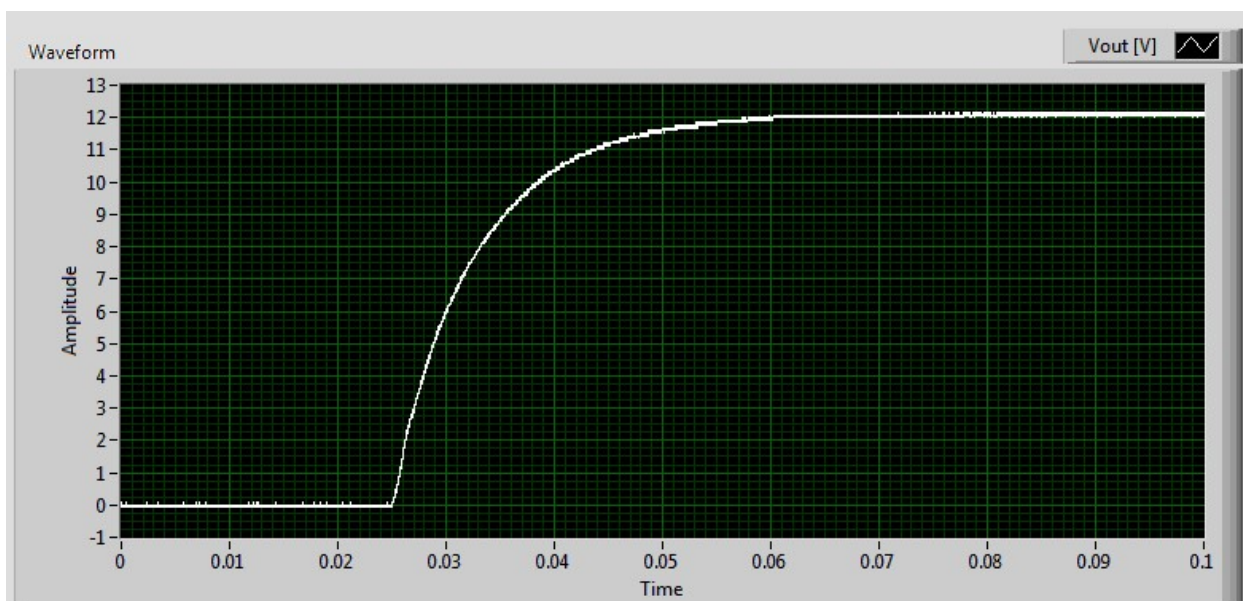

Figure 17: Rise Characteristics at Turn On 400VAC 0% load (CH1: Vout, 1V/div).

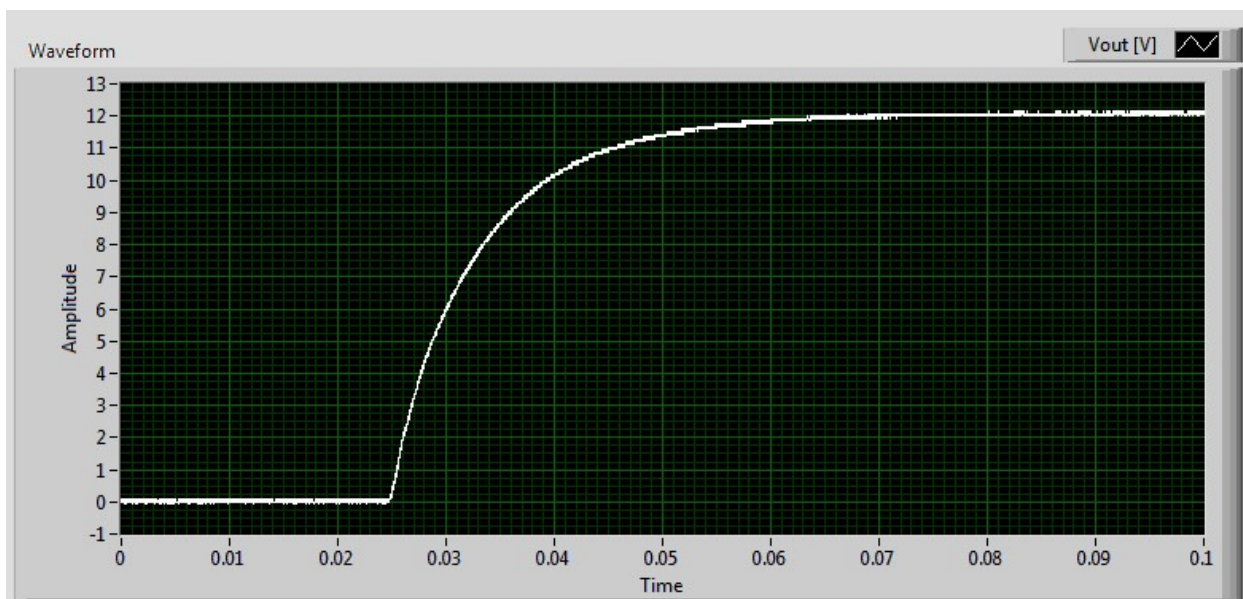

Figure 18: Rise Characteristics at Turn On 400VAC 100% load (CH1: Vout, 1V/div).



### Hold-Up Time Characteristics

$V_{out} = 12V_{dc}$ ,  $T_a = 25^{\circ}C$ , 100% Load = 167A

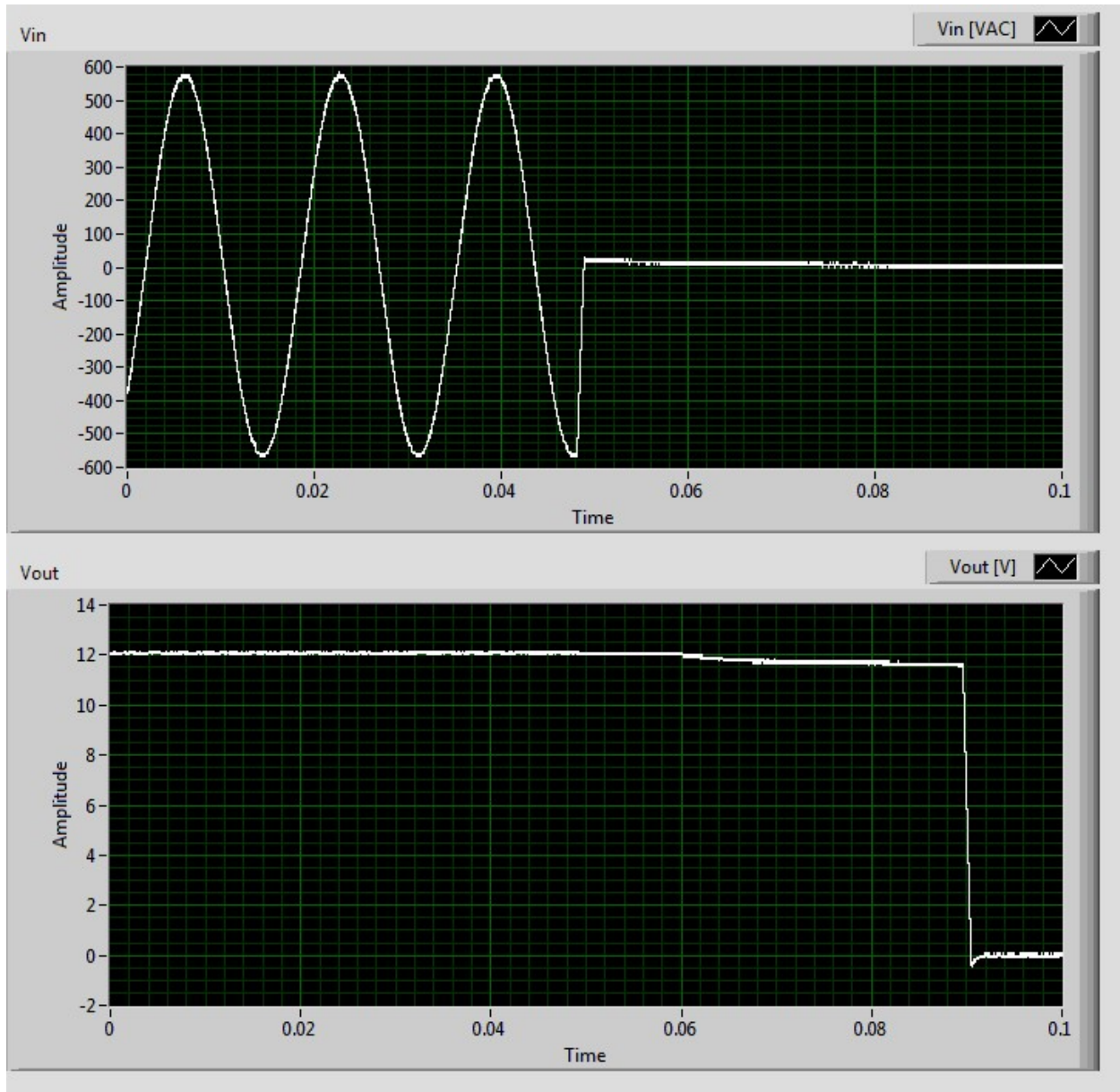

Figure 19: HOLD-UP TIME 400VAC 100% Load  
( CH1: Vin, 100V/div, CH2:Vout, 2V/div) .

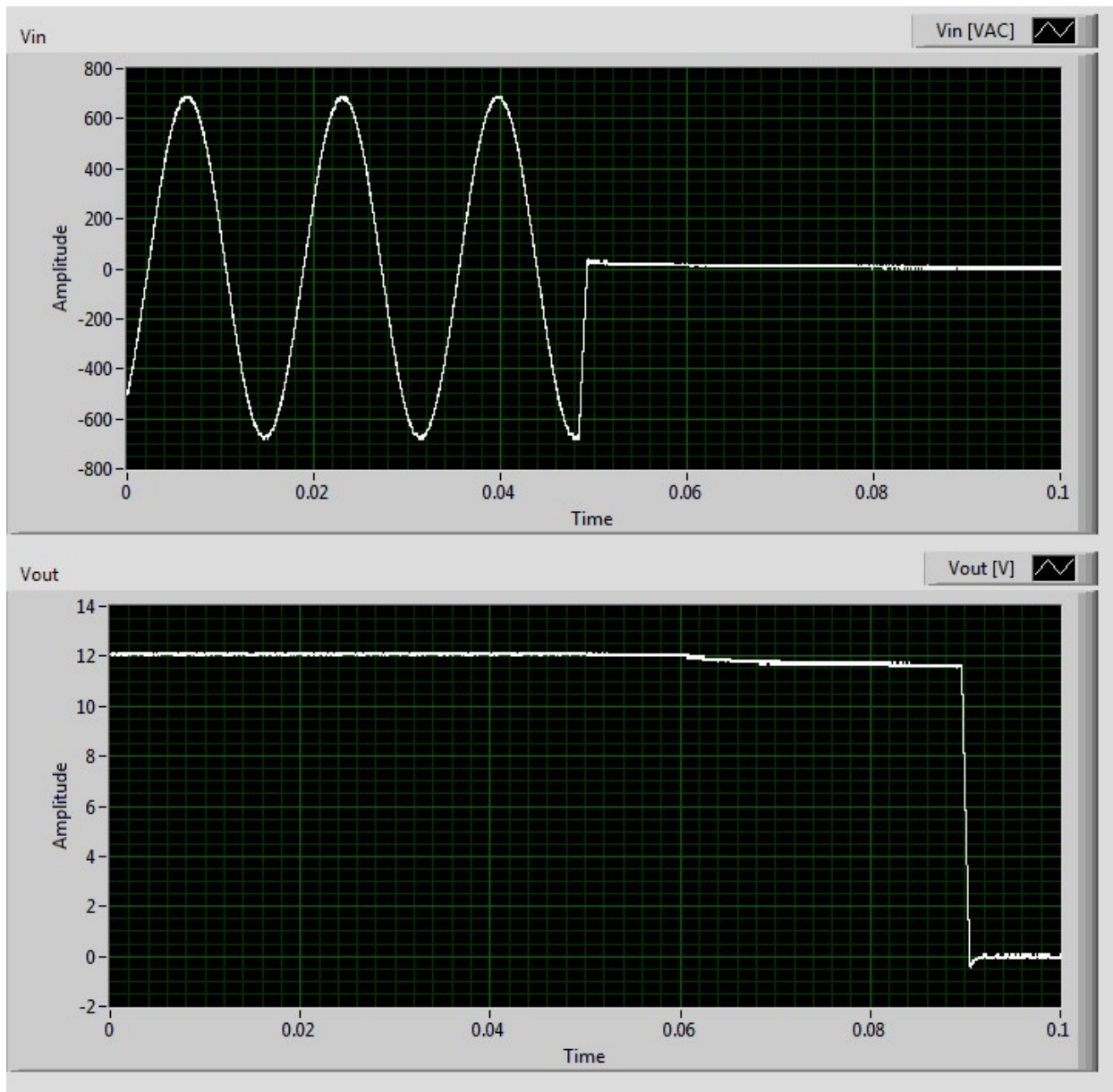

Figure 20: HOLD-UP TIME 480VAC 100% Load  
(CH1: Vin, 200V/div, CH2: Vout, 2V/div).



## Ripple Characteristics

Ripple and Noise: 120mV pk-pk max, 20MHz bandwidth. Jeita RC-9131C Procedure.  
Vout = 12Vdc, Ta=25°C, 100% Load = 167A

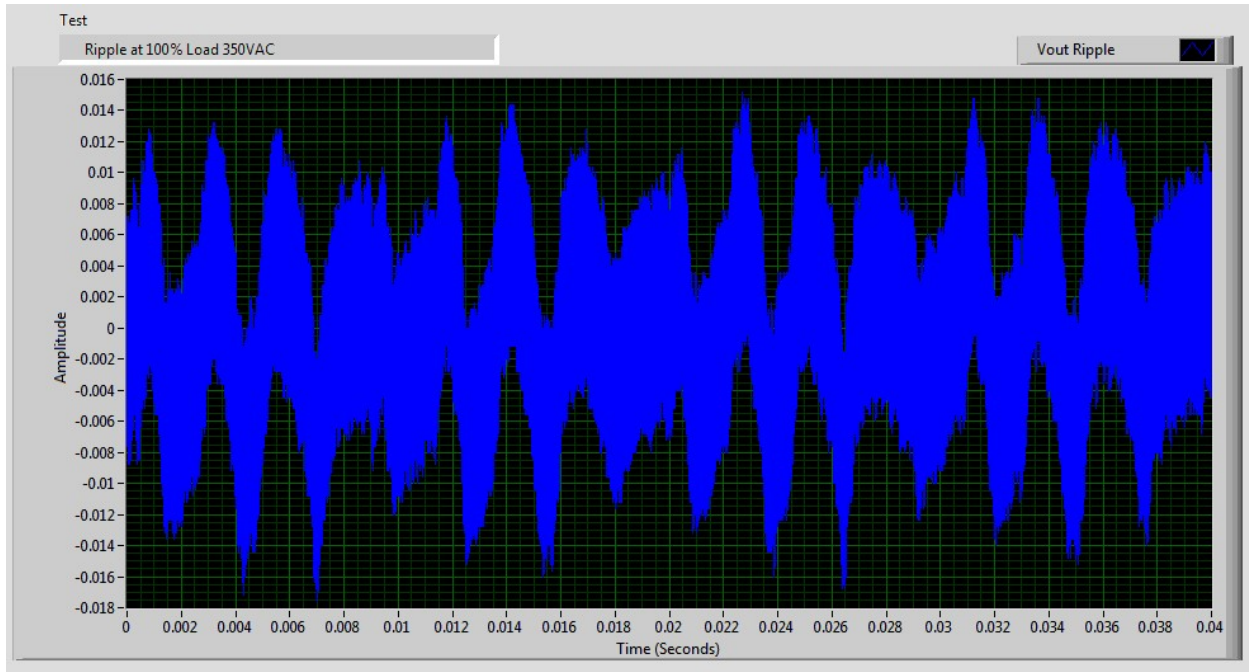

Figure 21: Ripple at 100% Load @ 350VAC.  
(CH1: Vout, 2mV/div, Timebase = 2ms/div)

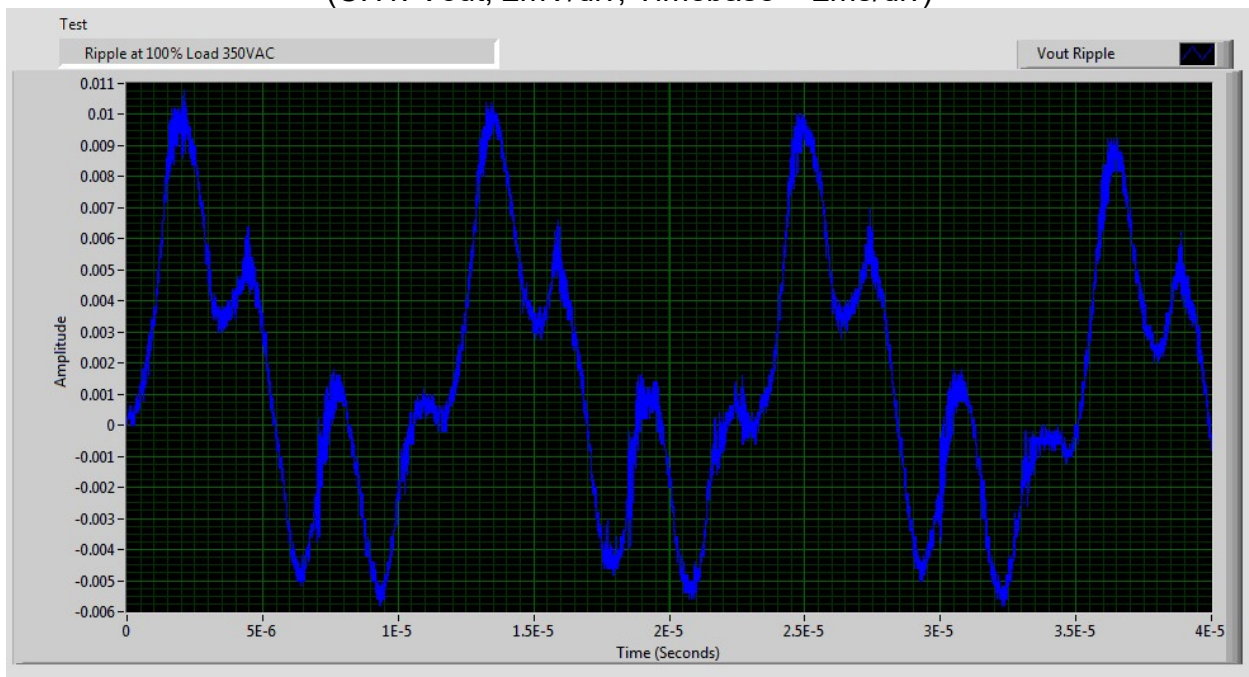

Figure 22: Ripple at 100% Load @ 350VAC.  
(CH1: Vout, 1mV/div, Timebase = 5µs/div).

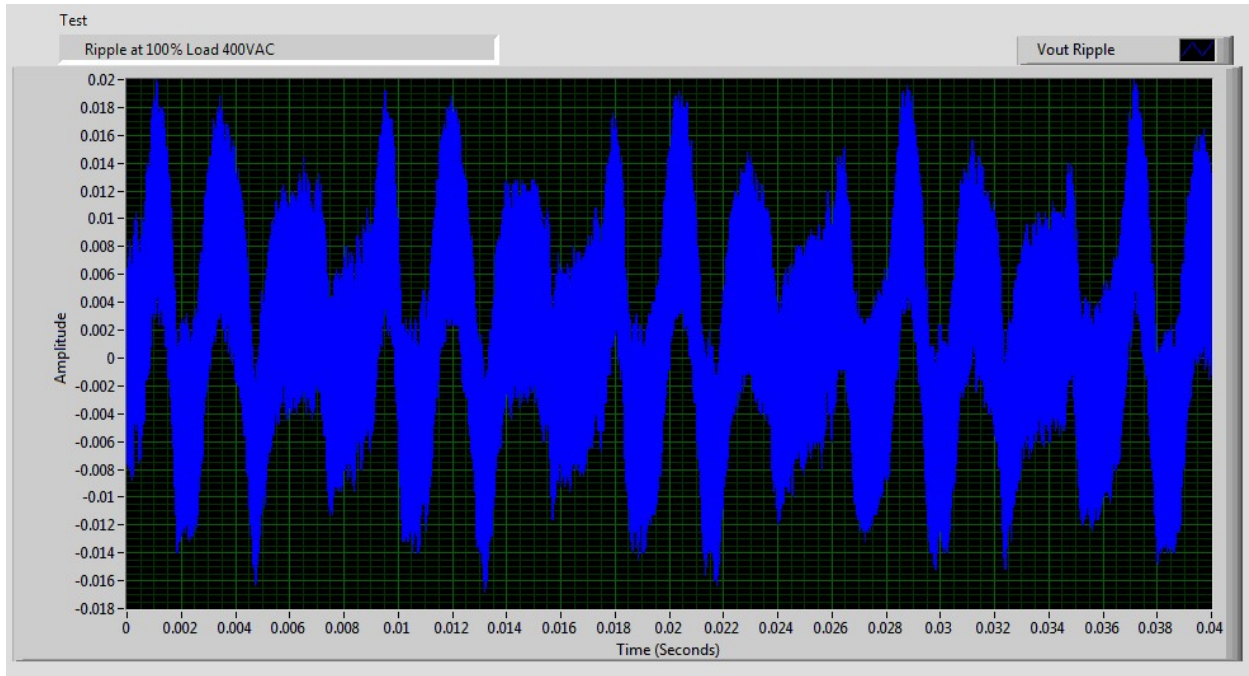

Figure 23: Ripple at 100% Load @ 400VAC.  
 (CH1: Vout, 2mV/div, Timebase = 2ms/div)

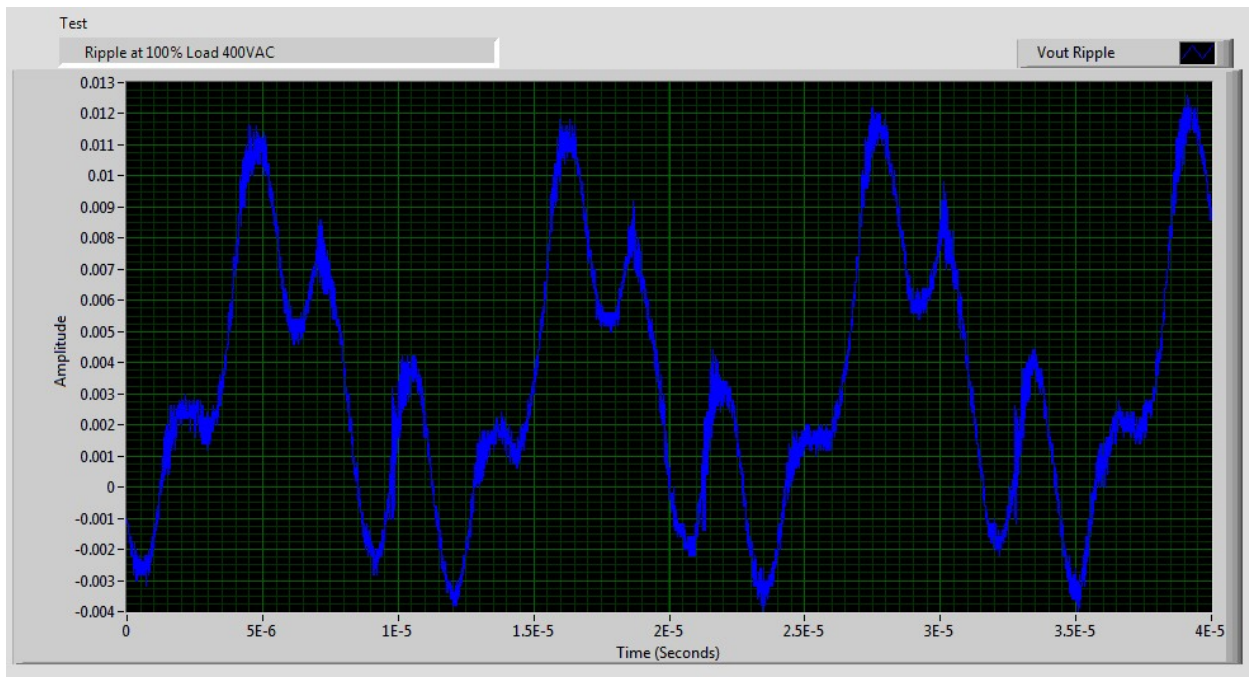

Figure 24: Ripple at 100% Load @ 400VAC.  
 (CH1: Vout, 1mV/div, Timebase = 5µs/div)



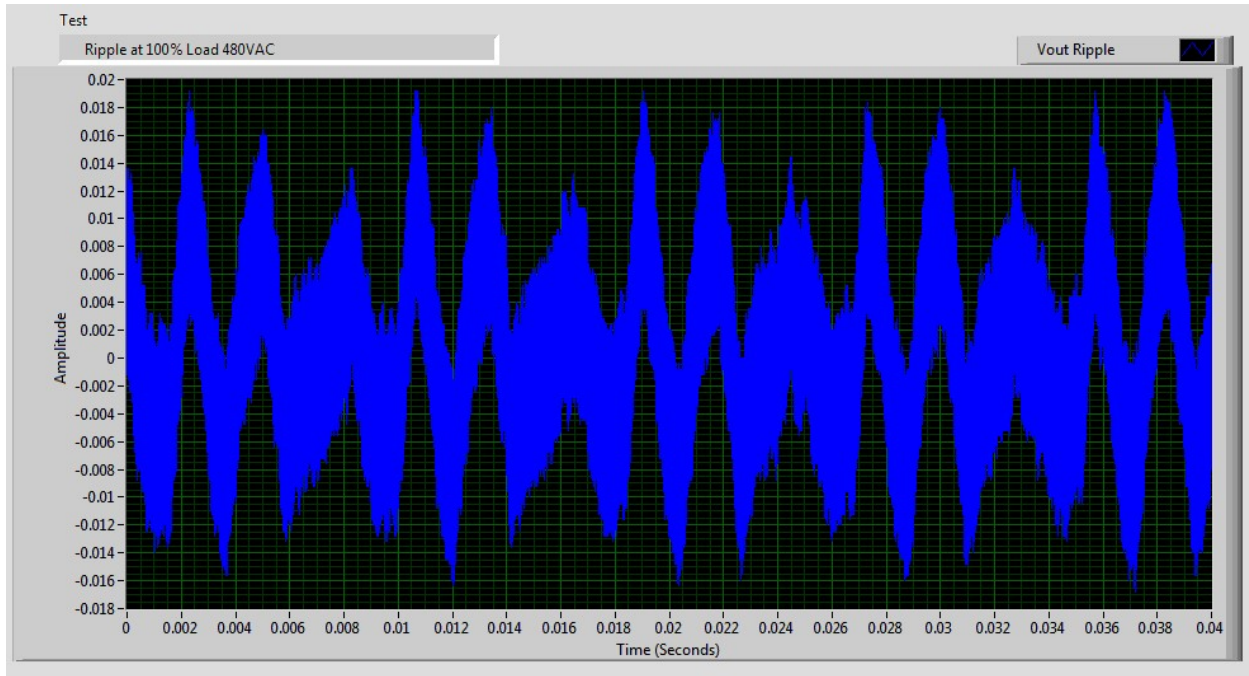

Figure 25: Ripple at 100% Load @ 480VAC.  
(CH1: Vout, 2mV/div, Timebase = 2ms/div)

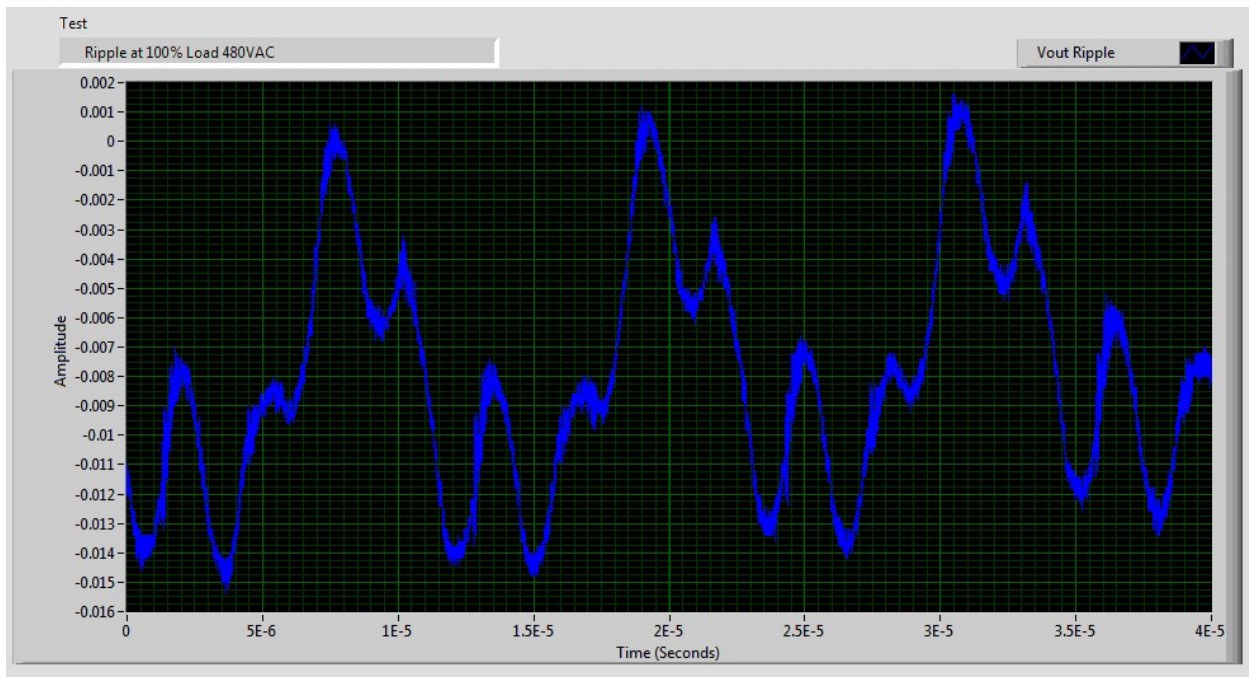

Figure 26: Ripple at 100% Load @ 480VAC.  
(CH1: Vout, 1mV/div, Timebase = 5μs/div)

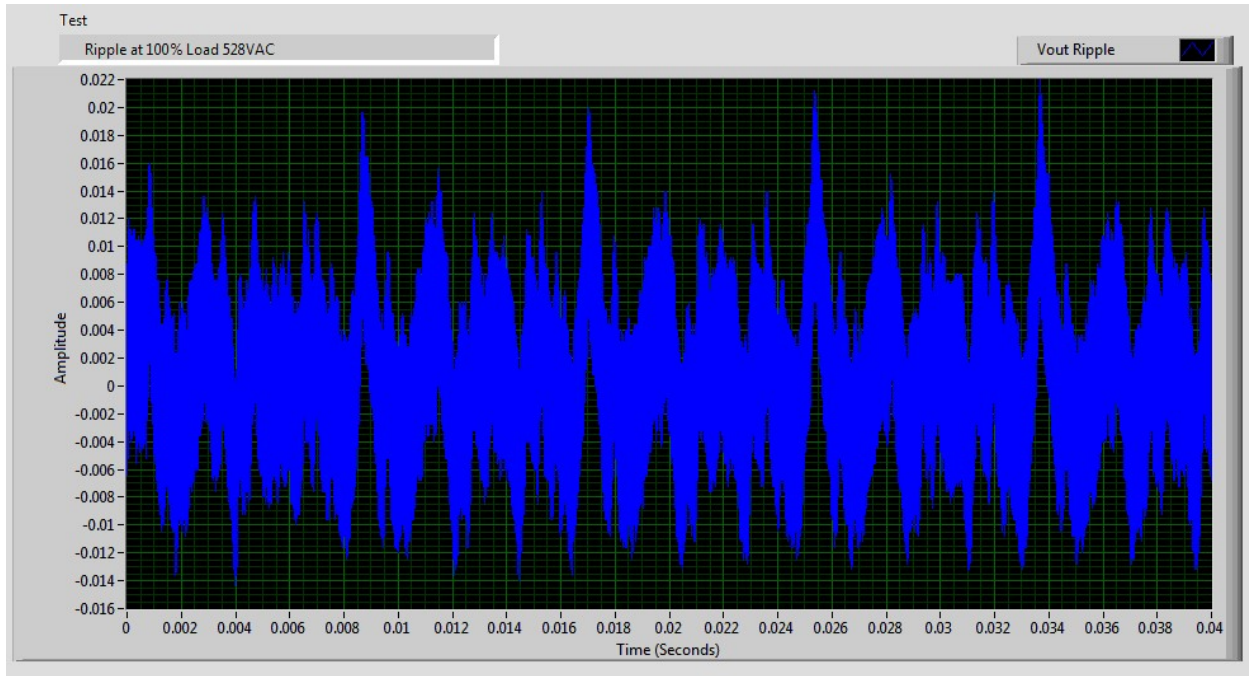

Figure 27: Ripple at 100% Load @ 528VAC.  
(CH1: Vout, 2mV/div, Timebase = 2ms/div)

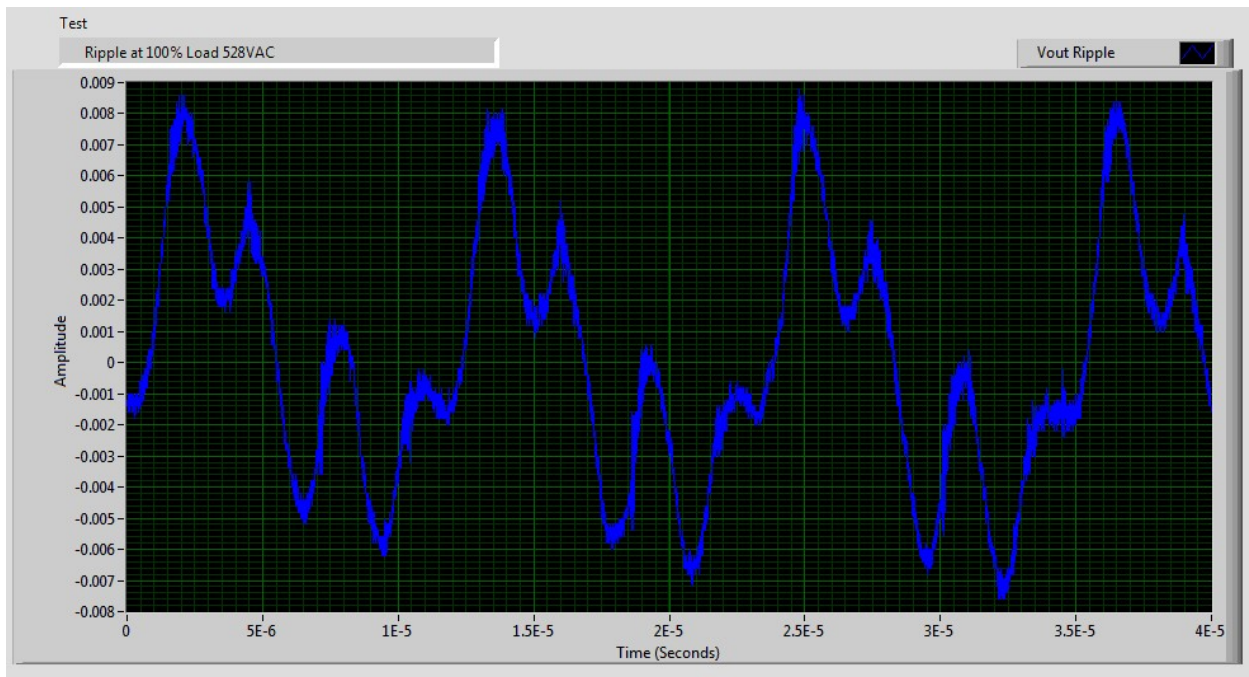

Figure 28: Ripple at 100% Load @ 528VAC.  
(CH1: Vout, 1mV/div, Timebase = 5μs/div)

### OCP Characteristics

$V_{out} = 12V_{dc}$ ,  $T_a = 25^{\circ}C$

#### Local Mode

In local mode, the current setpoint is adjustable via either the Ilimit Adjust trim pot ( $I_{LIMIT ADJ}$ ) or by applying a DC voltage to Signals Connector between pin #. 10 ( $I_{ADJ}$ ) and pin # 18 (-SNS or -Sense). See User manual for details.

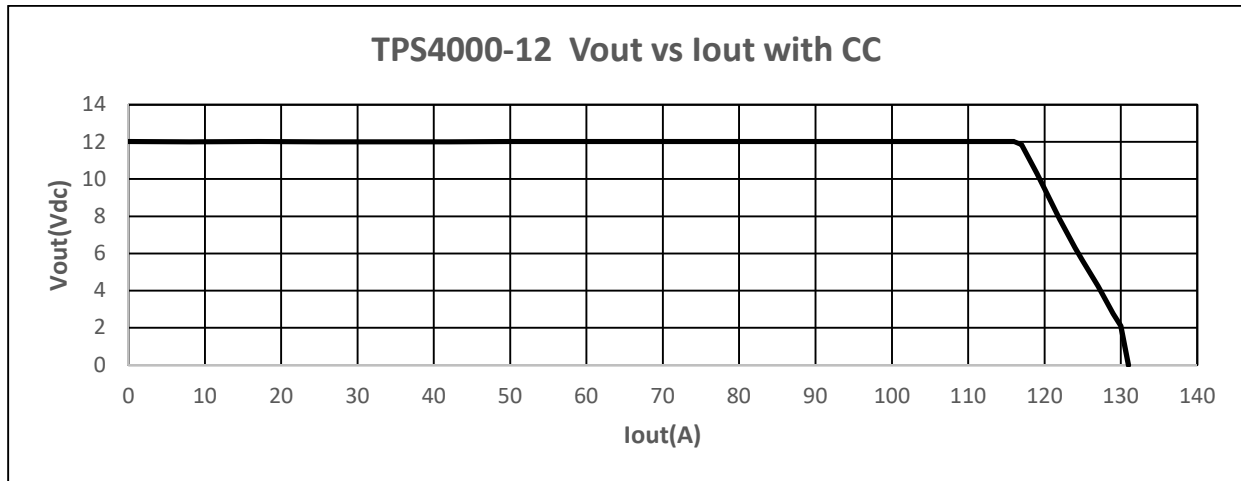

Figure 29: OCP Dropout Curve. Ilimit setpoint= 117A. Local Mode

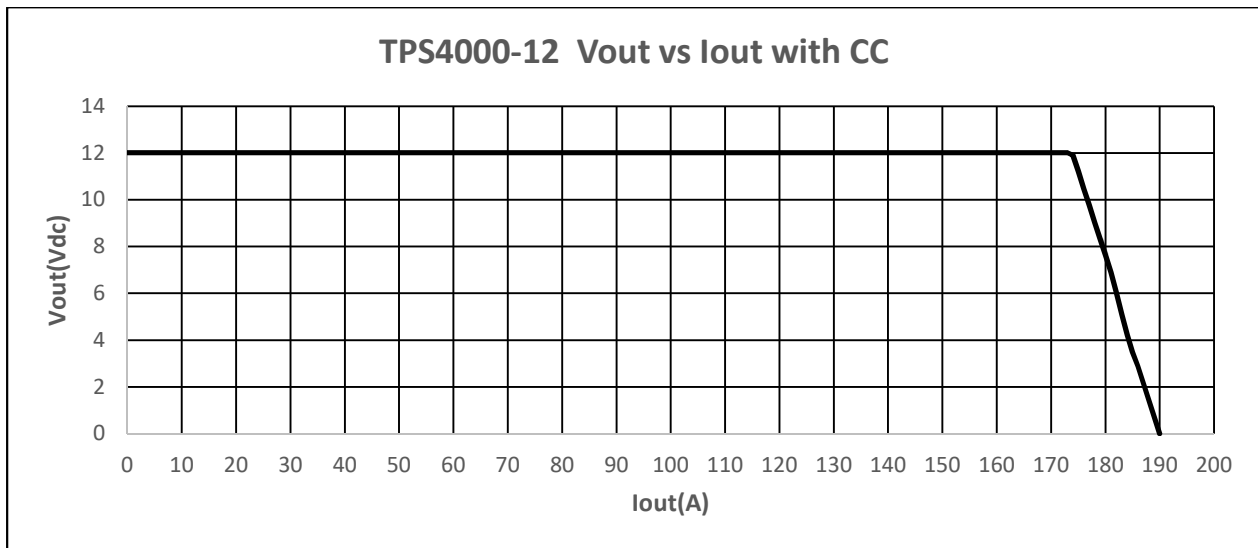

Figure 30: OCP Dropout Curve. Ilimit setpoint= 174A. Local Mode.

**Note 2:** Final OCP set point depends on the adjustment of trim Pot ( $I_{LIMIT ADJ}$ ) and the voltage level applied to terminal ( $I_{ADJ}$ ).



### Remote Mode

In remote mode, the current limit setpoint is programmable via the I2C Connector.

Programmed Current Limit at <u>Value</u> (Code) (Code)=(Nh,Nd):Nd(Dec)=(Value*24-304)*1 Nd(Dec)→Nh(Hex)	Actual Current Limit(A)
Current Limit when Ilim at 100.2A (0835h, 2101d)	100.2
Current Limit when Ilim at 116.9A (09C6h, 2502d)	116.9
Current Limit when Ilim at 133.6A (0B56h, 2902d)	135.27
Current Limit when Ilim at 150.3A (0CE7h, 3303d)	151.97
Current Limit when Ilim at 167.0A (0E78h, 3704d)	170.34
Current Limit when Ilim at 175.3A (0F3Fh, 3903d)	178.69

**Note 3:** PMBus setting are not stored after Input AC source power cycling

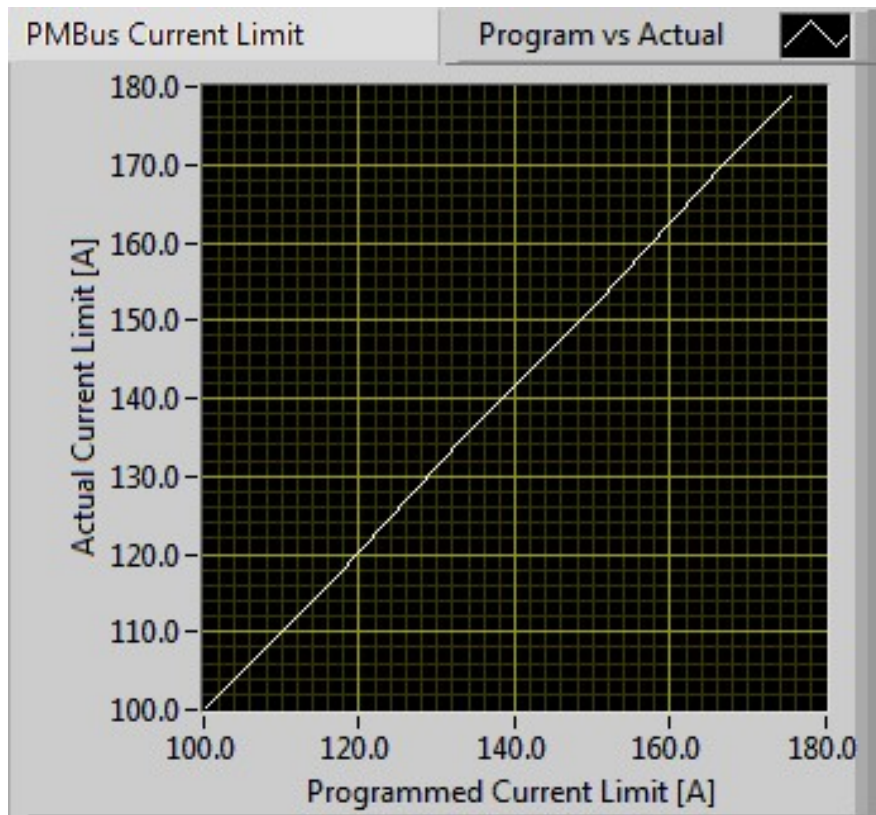

## Conducted Emissions

EN 55032:2015 Class A/ FCC Part 15 Class A

(Note: Limits of EN 55032 and FCC Part 15 are identical)

Vout = 12Vdc, Ta=25°C, 100% Load = 167A

Report No. SD72130536-0817



### 2.1.11 FCC Part 15 Subpart B / EN 55032 Line 1 (400VAC/60Hz)

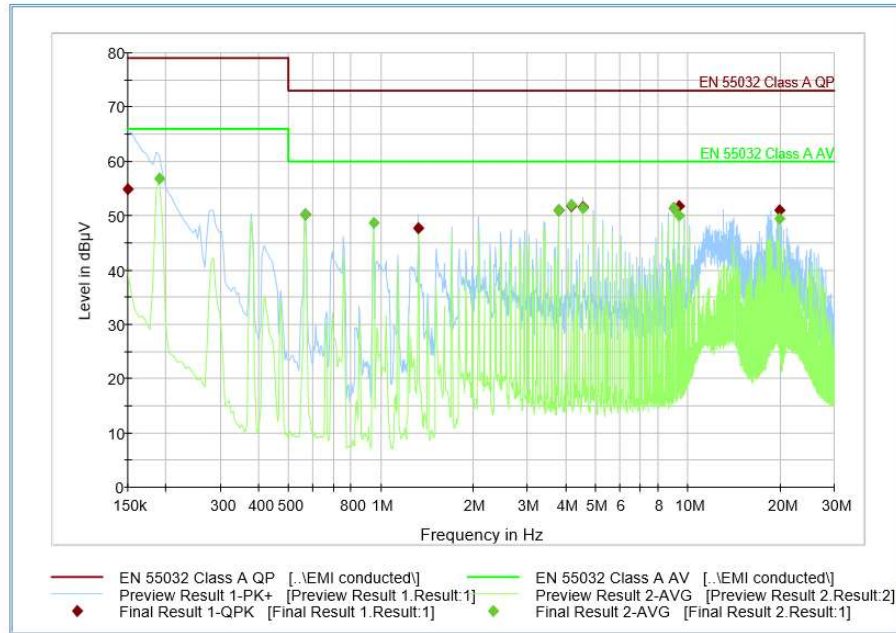

Note: Limits of FCC Part 15 Subpart B and EN 55032 are identical

Figure 31: Line 1 Conducted Emissions. Vin = 400VAC



2.1.12 FCC Part 15 Subpart B / EN 55032 Line 2 (400VAC/60Hz)

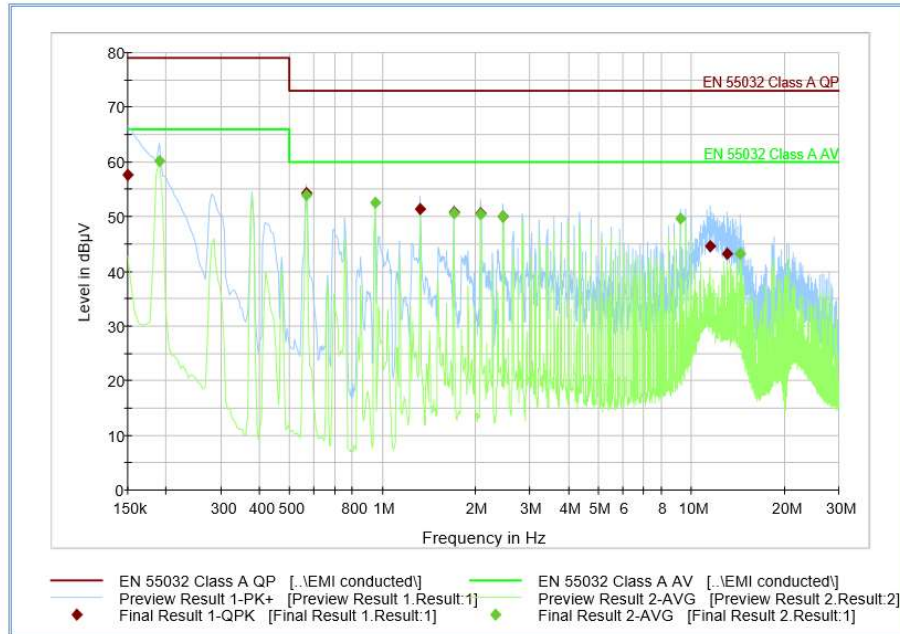

Note: Limits of FCC Part 15 Subpart B and EN 55032 are identical

Figure 32: Line 2 Conducted Emissions. Vin = 400VAC





2.1.13 FCC Part 15 Subpart B / EN 55032 Line 3 (400VAC/60Hz)

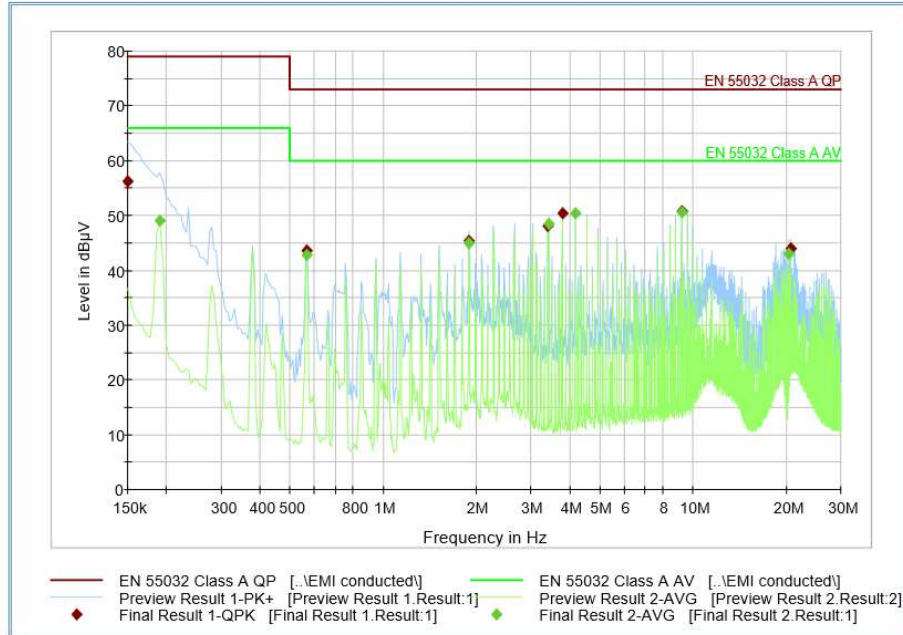

Note: Limits of FCC Part 15 Subpart B and EN 55032 are identical

Figure 33: Line 3 Conducted Emissions. Vin = 400VAC

## Radiated Emissions

EN55032 Class A /FCC Part 15 Class A

Vout =12Vdc/24Vdc, Ta=25°C, %100 Load = 167A

Report No. SD72130536-0817



### 2.2.11 Below 1GHz Radiated Emission Test (EN 55032)

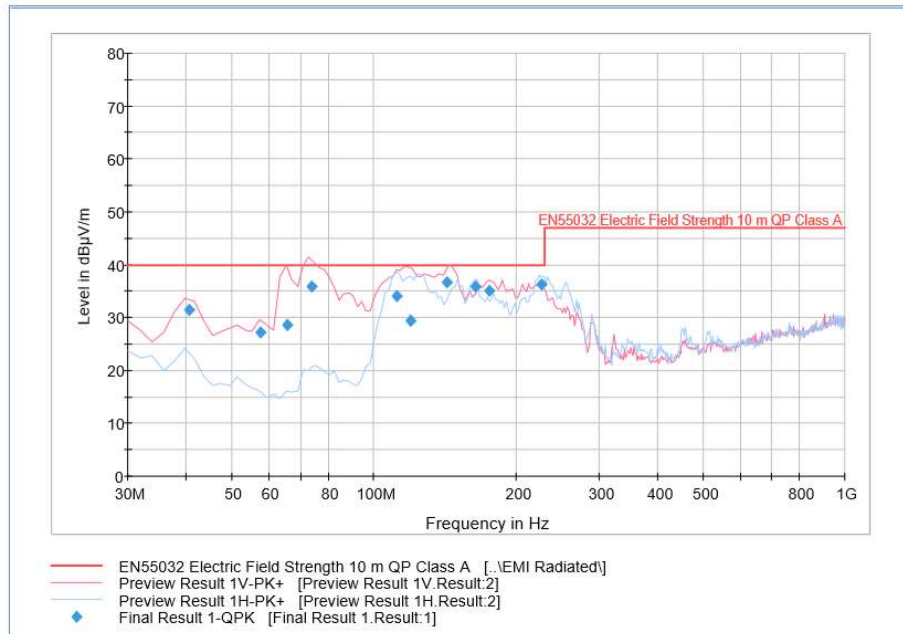

Figure 34: EN55032 Class A Radiated Emissions



**2.2.12 Below 1GHz Radiated Emission Test (FCC Part 15 Subpart B)**

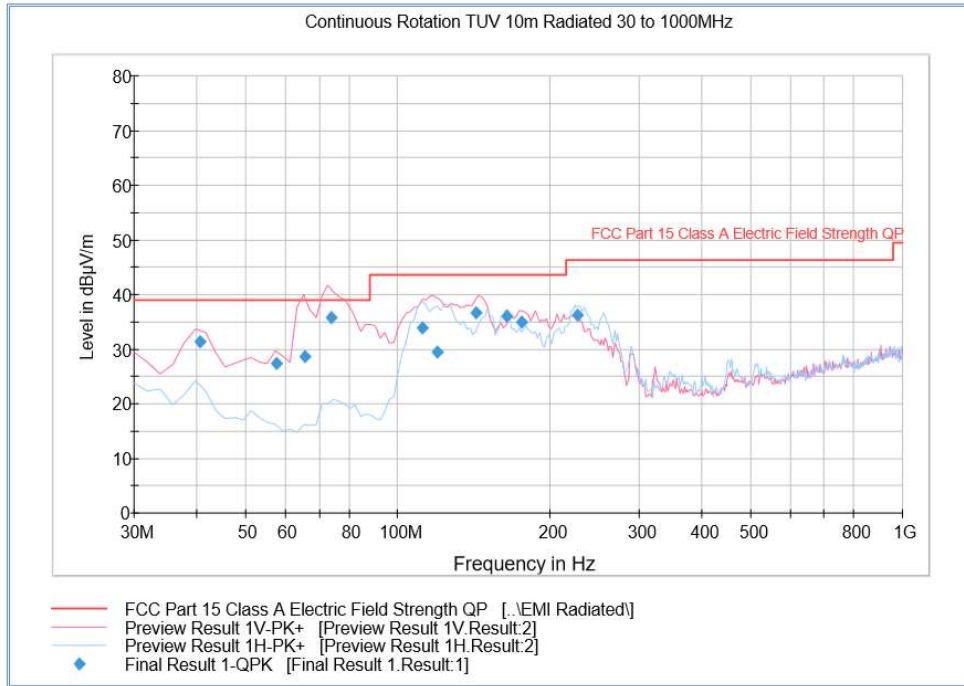

Figure 35: FCC Part 15 Class A Radiated Emissions

## Current Share

$V_{in} = 480VAC$ ,  $V_{out} = 12Vdc$ ,  $T_a = 25^{\circ}C$

### Parallel Operation Setup

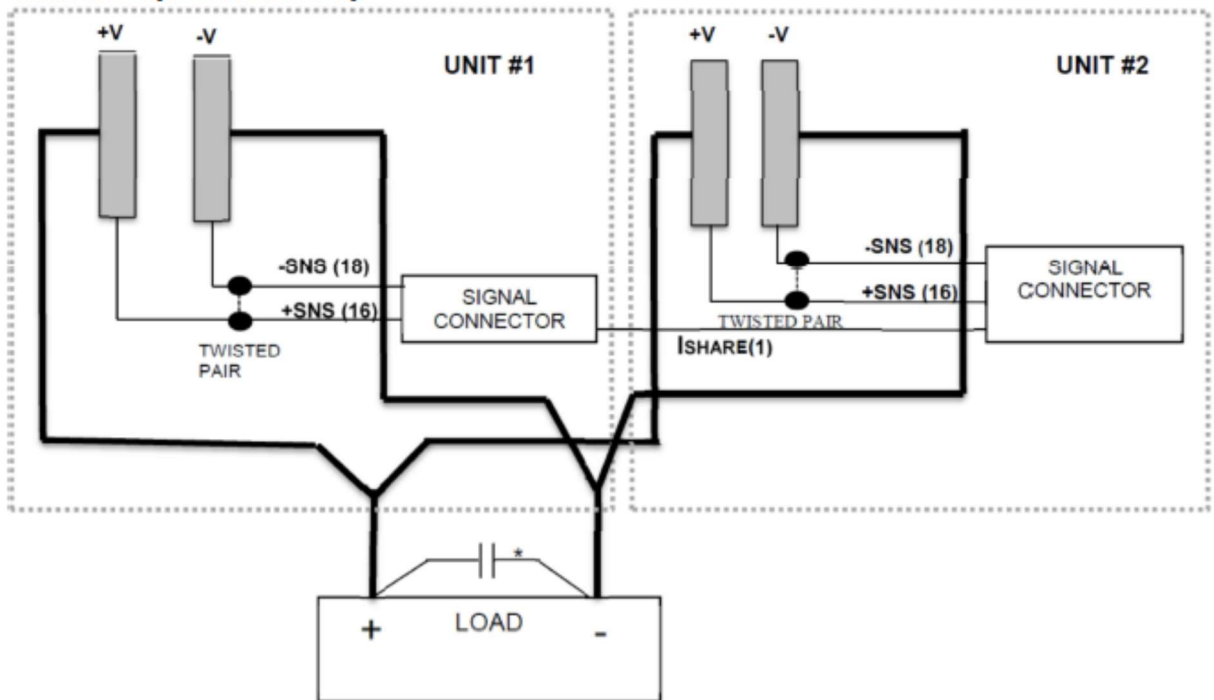
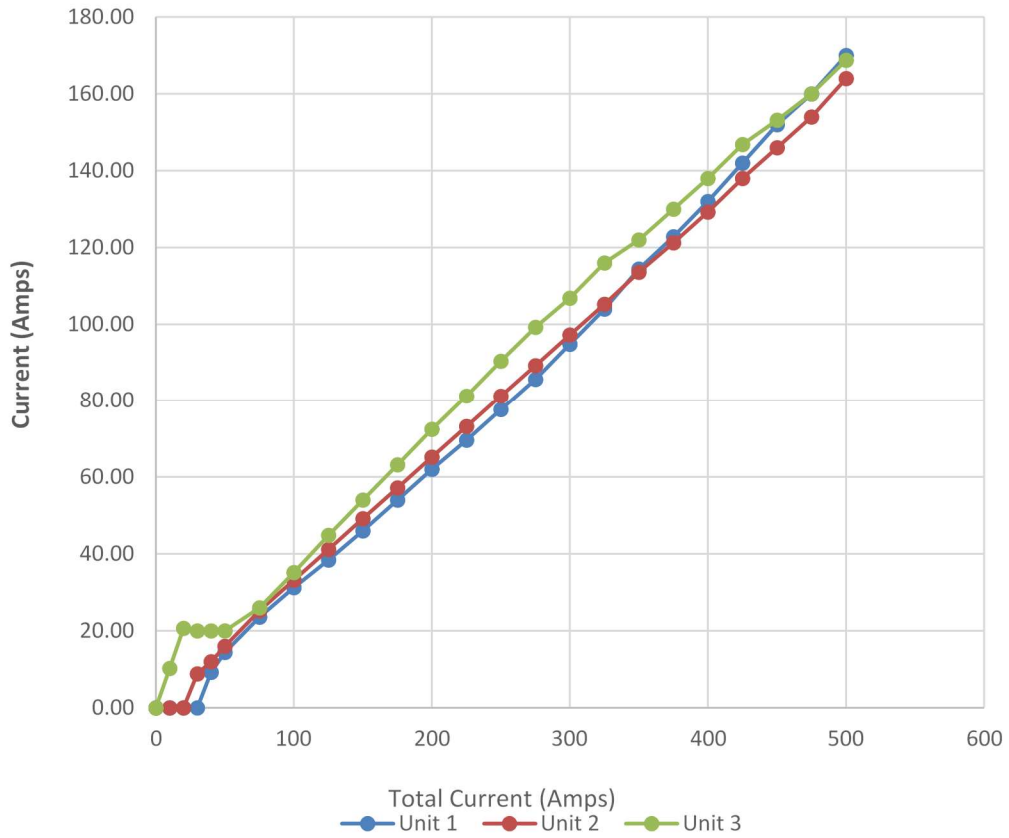

Figure 36: Typical Local Sense Parallel Operation Setup

### Current Share - Local Sensing



Vin=480Vac

Tamb=25°C

<b>I<sub>total</sub></b>	<b>I<sub>1</sub>(A)</b>	<b>I<sub>2</sub>(A)</b>	<b>I<sub>3</sub>(A)</b>	<b>Delta I [% of I<sub>total</sub>]</b>
0	0.00	0.00	0.00	N/A
10	0.00	0.00	10.20	102.00%
20	0.00	0.00	20.68	103.40%
30	0.00	8.80	20.00	66.67%
40	9.20	12.00	20.00	27.00%
50	14.40	16.00	20.00	11.20%
75	23.60	25.20	26.00	3.20%
100	31.20	33.20	35.20	4.00%
125	38.40	41.20	44.80	5.12%
150	46.00	49.20	54.00	5.33%
175	54.00	57.20	63.20	5.26%
200	62.00	65.20	72.40	5.20%
225	69.60	73.20	81.20	5.16%
250	77.60	81.20	90.40	5.12%
275	85.60	89.20	99.20	4.95%
300	94.80	97.20	106.80	4.00%
325	104.00	105.20	116.00	3.69%
350	114.40	113.60	122.00	2.40%
375	122.80	121.20	130.00	2.35%
400	132.00	129.20	138.00	2.20%
425	142.00	138.00	146.80	2.07%
450	152.00	146.00	153.20	1.60%
475	160.00	154.00	160.00	1.26%
500	170.00	164.00	168.80	1.20%

Table 1: Current Share - Local Sense (Sense signals connected to bus bars)

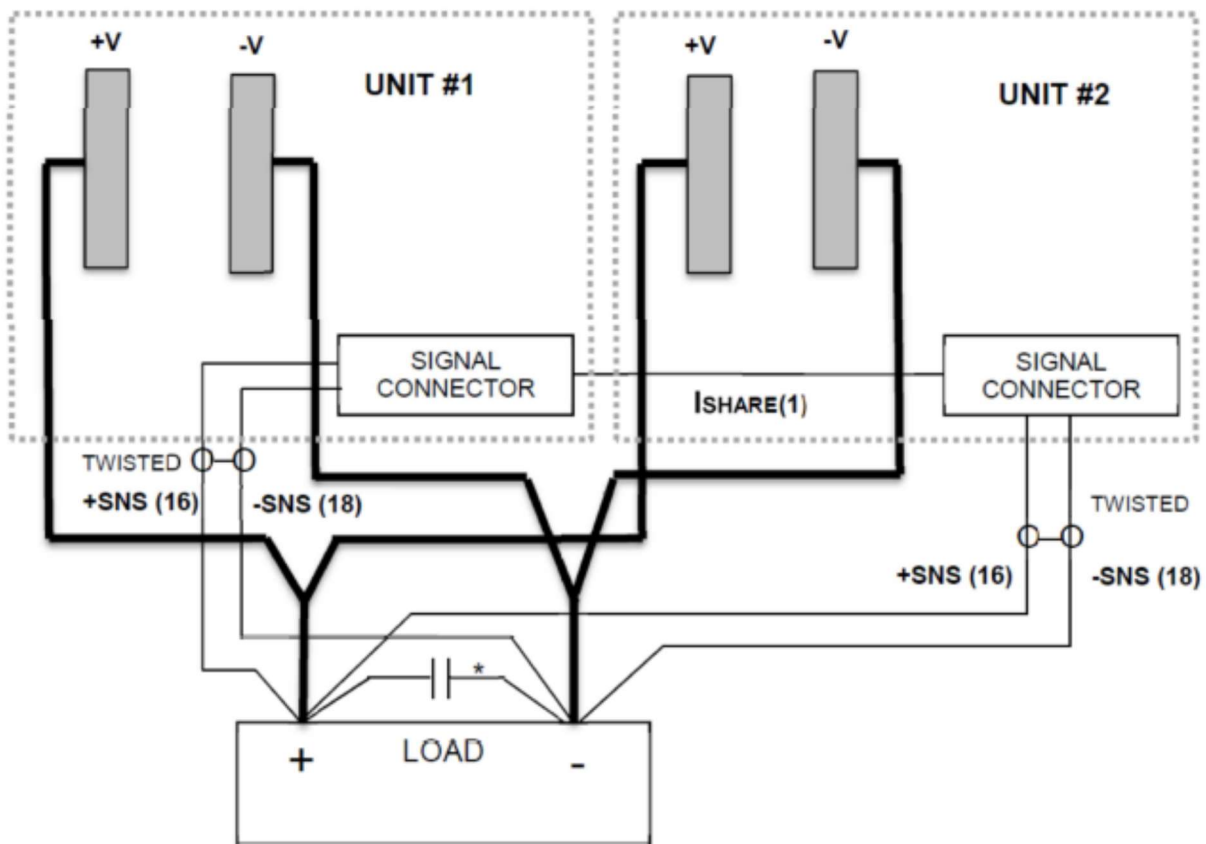
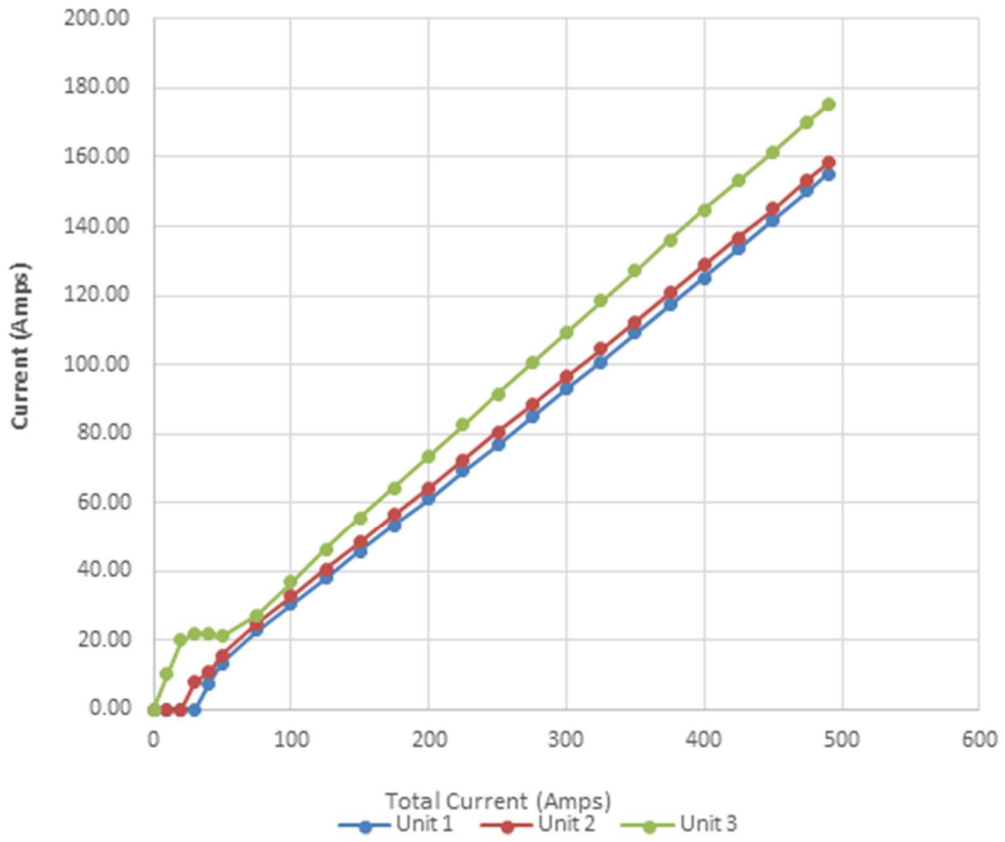

Figure 37: Typical Remote Sense Parallel Operation Setup

### Current Share - Remote Sensing





Vin=480Vac Tamb=25°C

<b>Itotal</b>	<b>I1(A)</b>	<b>I2(A)</b>	<b>I3(A)</b>	<b>Delta I [% of I total]</b>
0	0.00	0.00	0.00	N/A
10	0.00	0.00	10.00	100.00%
20	0.00	0.00	20.00	100.00%
30	0.00	8.00	22.00	73.33%
40	7.60	10.80	21.60	35.00%
50	13.20	15.60	21.20	16.00%
75	22.80	24.80	27.20	5.87%
100	30.40	32.80	36.80	6.40%
125	38.00	40.40	46.40	6.72%
150	45.60	48.40	55.60	6.67%
175	53.20	56.40	64.40	6.40%
200	61.20	64.40	73.60	6.20%
225	69.20	72.40	82.40	5.87%
250	76.80	80.40	91.60	5.92%
275	84.80	88.40	100.40	5.67%
300	92.80	96.40	109.20	5.47%
325	100.80	104.40	118.40	5.42%
350	109.20	112.40	127.20	5.14%
375	117.20	120.80	136.00	5.01%
400	125.20	128.80	144.80	4.90%
425	133.60	136.80	153.20	4.61%
450	142.00	145.20	161.60	4.36%
475	150.40	153.60	170.40	4.21%
490	155.20	158.40	175.20	4.08%

Table 2: Current Share- Remote Sense (Sense signals connected at load)