

UNA350P *

EVALUATION DATA

型式データ

DWG No. DA003-53-01		
APPD	CHK	DWG
<i>Y. Nishizawa</i>	<i>K. Asano</i>	<i>K. Shimohara</i>
18. Nov. 2004	18. Nov. 2004	18. Nov. 2004

INDEX

1. 測定方法	Evaluation Method	PAGE
1.1	測定回路 Circuit used for determination	T-1~5
	(1) 静特性 Steady state data	
	(2) 通電ドリフト特性 Warm up voltage drift characteristics	
	(3) 過電流保護特性 Over current protection (OCP) characteristics	
	(4) 過電圧保護特性 Over voltage protection (OVP) characteristics	
	(5) 出力立ち上がり特性 Output rise characteristics	
	(6) 出力立ち下がり特性 Output fall characteristics	
	(7) 出力立ち上がり特性 (ON/OFFコントロール時) Output rise characteristics with ON/OFF CONTROL	
	(8) 出力立ち下がり特性 (ON/OFFコントロール時) Output fall characteristics with ON/OFF CONTROL	
	(9) 出力保持時間特性 Hold up time characteristics	
	(10) 過渡応答 (入力急変) 特性 Dynamic line response characteristics	
	(11) 過渡応答 (負荷急変) 特性 Dynamic load response characteristics	
	(12) 入力電圧瞬停特性 Momentary line voltage drop characteristics	
	(13) 入力サージ電流 (突入電流) 特性 Inrush current characteristics	
	(14) 瞬停時突入電流特性 Inrush current characteristics	
	(15) 入力電流波形 Input current waveform	
	(16) リーク電流特性 Leakage current characteristics	
	(17) 出力リップル、ノイズ波形 Output ripple and noise waveform	
	(18) EMI特性 Electro-Magnetic Interference characteristics	
1.2	使用測定機器 List of equipment used	T-6
1.3	負荷条件 Load condition	T-7
2.	特性データ Characteristics	
2.1	静特性 Steady state data	
	(1) 入力、負荷・温度変動 Regulation - line and load, temperature drift	T-8~20
	(2) 出力電圧、リップル電圧対入力電圧 Output voltage and ripple voltage vs. input voltage	T-21~33
	(3) 効率、入力電流対出力電流 Efficiency and input current vs. output current	T-34~37
	(4) 力率、入力電流対出力電流 Power factor and input current vs. output current	T-38~39
2.2	通電ドリフト特性 Warm up voltage drift characteristics	T-40~45
2.3	過電流保護特性 Over current protection (OCP) characteristics	T-46~48
2.4	過電圧保護特性 Over voltage protection (OVP) characteristics	T-49
2.5	出力立ち上がり特性 Output rise characteristics	T-50
2.6	出力立ち下がり特性 Output fall characteristics	T-51

2.7	ON/OFFコントロール時出力立ち上がり特性	Output rise characteristics with ON/OFF CONTROL	T-52~57
2.8	ON/OFFコントロール時出力立ち下がり特性	Output fall characteristics with ON/OFF CONTROL	T-58~63
2.9	出力保持時間特性	Hold up time characteristics	T-64
2.10	過渡応答（入力急変）特性	Dynamic line response characteristics	T-65~70
2.11	過渡応答（負荷急変）特性	Dynamic load response characteristics	T-71~82
2.12	入力電圧瞬停特性	Momentary line voltage drop characteristics	T-83~88
2.13	入力サージ電流（突入電流）特性	Inrush current waveform	T-89~90
2.14	瞬停時突入電流特性	Inrush current characteristics	T-91
2.15	入力電流波形	Input current waveform	T-92
2.16	高調波成分	Input current harmonics	T-93
2.17	リーク電流特性	Leakage current characteristics	T-94
2.18	出力リップル、ノイズ波形	Output ripple and noise waveform	T-95~108
2.19	EMI特性	Electro-Magnetic Interference characteristics	T-109~111

使用記号 Terminology used

	Definition	
V_{in} 入力電圧	Input voltage
$V_{out}(V_o)$ 出力電圧	Output voltage
I_{in} 入力電流	Input current
$I_{out}(I_o)$ 出力電流	Output current
T_a 周囲温度	Ambient temperature

1. 1 測定回路

Circuit used for determination

(1) 静特性

Steady state data

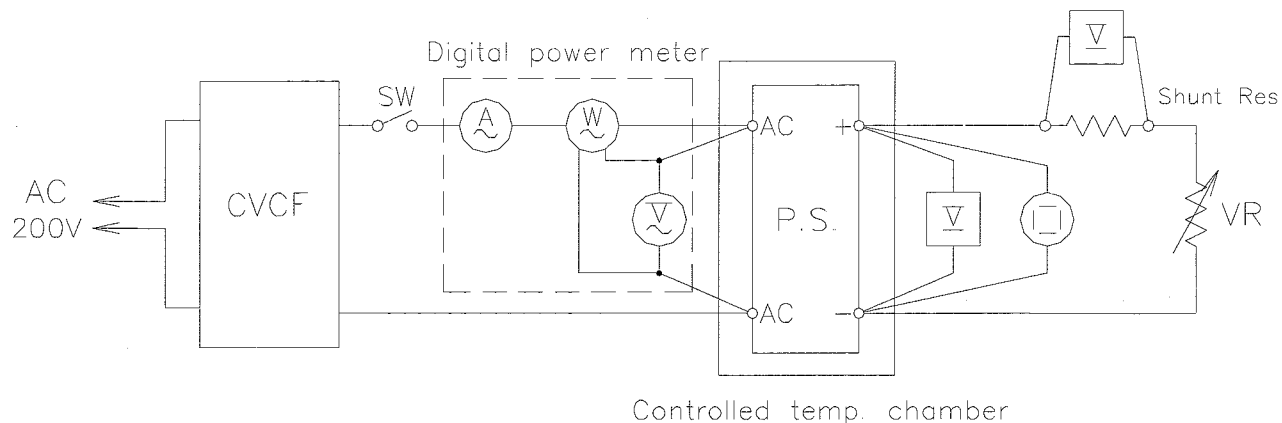

(2) 通電ドリフト特性

Warm up voltage drift characteristics

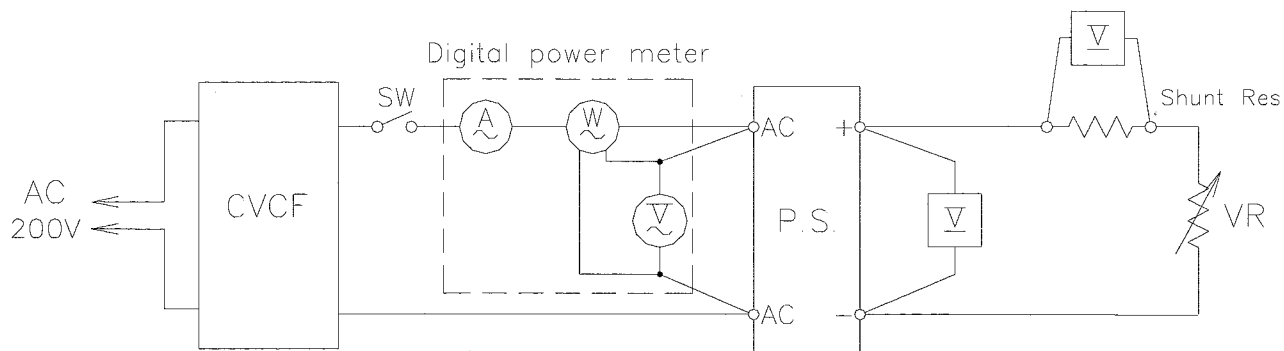

(3) 過電流保護特性

Over current protection (OCP) characteristics

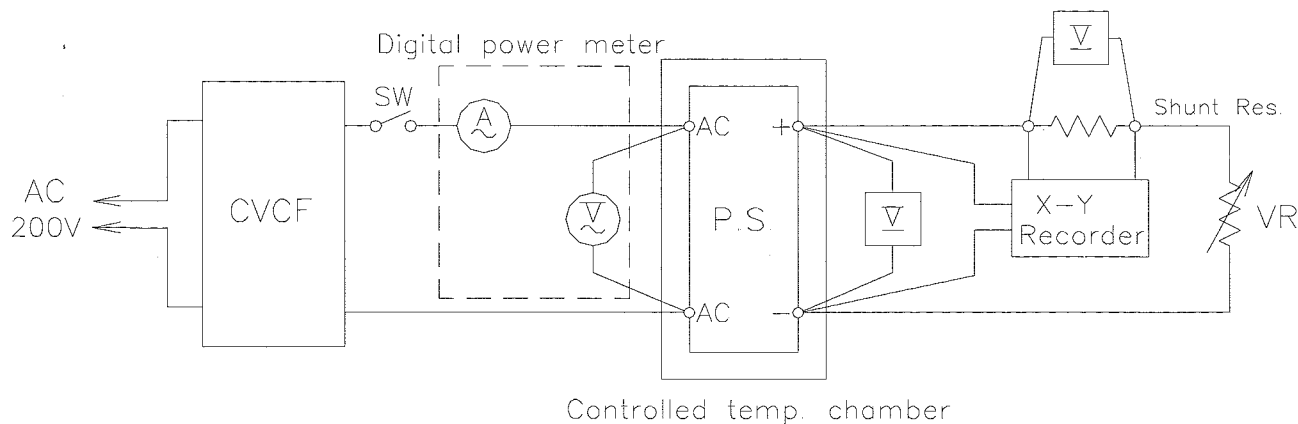

(4) 過電圧保護特性

Over voltage protection (OVP) characteristics

静特性と同じ

Same as steady state data

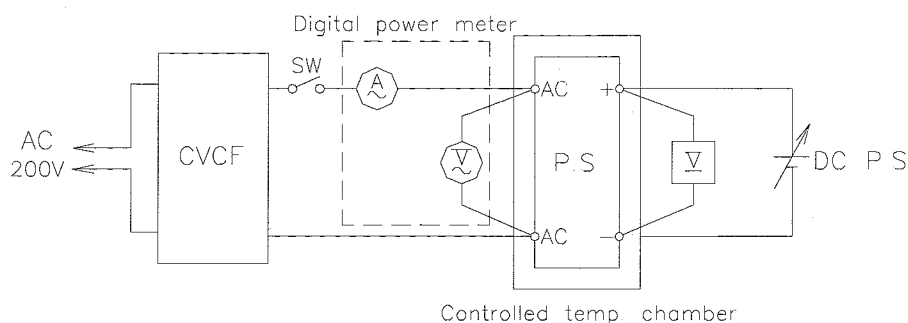

(5) 出力立ち上がり特性

Output rise characteristics

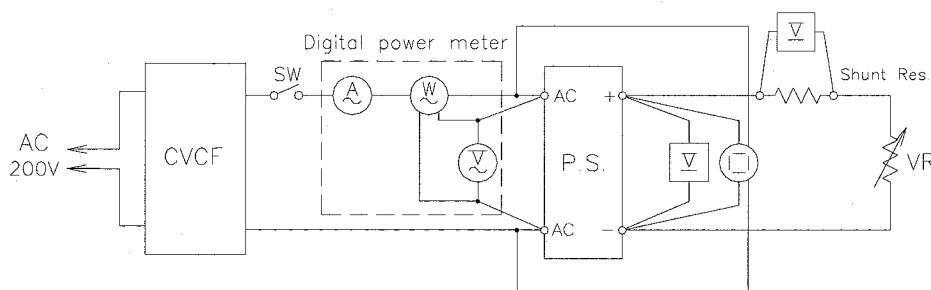

(6) 出力立ち下がり特性

Output fall characteristics

出力立ち上がり特性と同じ

Same as output rise characteristics

(7) 出力立ち上がり特性 (ON/OFFコントロール時)

Output rise characteristics with ON/OFF CONTROL

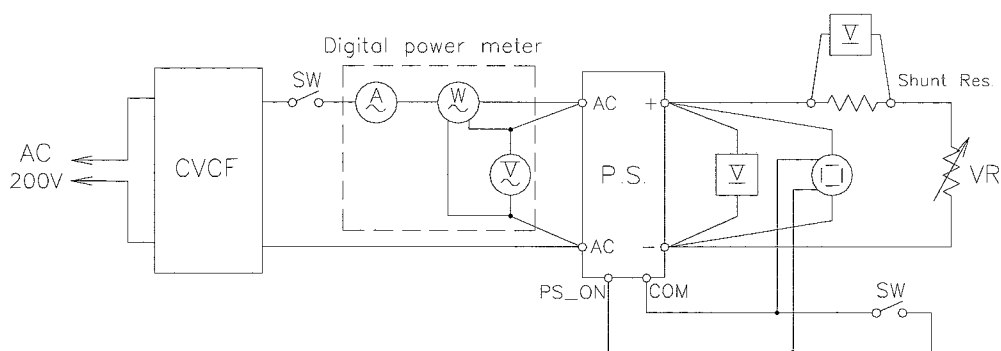

(8) 出力立ち下がり特性 (ON/OFFコントロール時)

Output fall characteristics with ON/OFF CONTROL

出力立ち上がり特性 (ON/OFFコントロール時) と同じ

Same as output rise characteristics with ON/OFF CONTROL

(9) 出力保持時間特性

Hold up time characteristics

出力立ち上がり特性と同じ

Same as output rise characteristics

(10) 過渡応答（入力急変）特性

Dynamic line response characteristics

出力立ち上がり特性と同じ

Same as output rise characteristics

(11) 過渡応答（負荷急変）特性

Dynamic load response characteristics

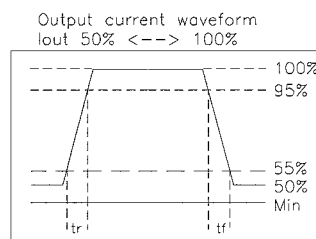
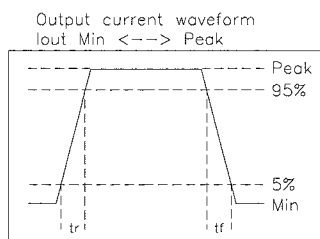
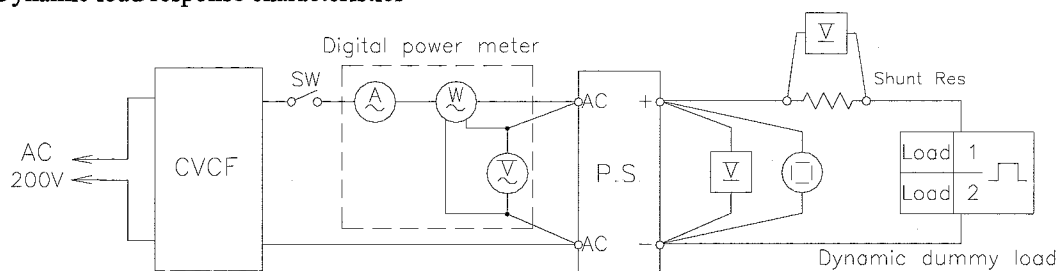

(12) 入力電圧瞬停特性

Response to brown out characteristics

出力立ち上がり特性と同じ

Same as output rise characteristics

(13) 入力サージ電流（突入電流）特性

Inrush current characteristics

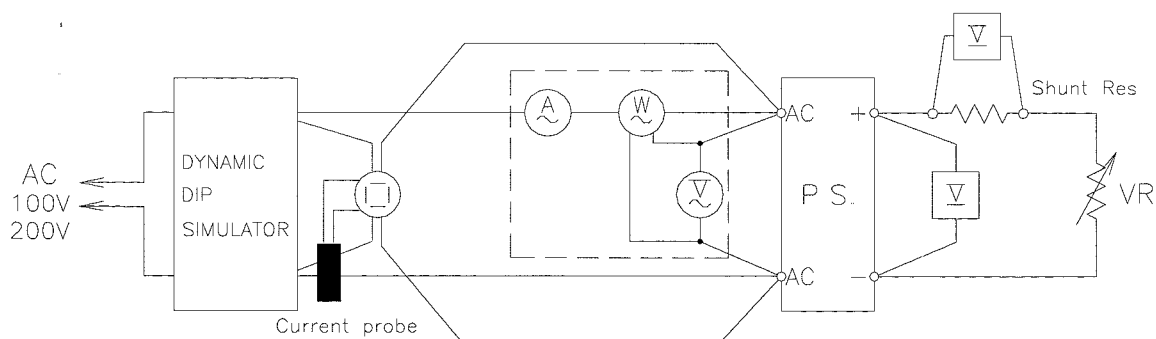

(14) 瞬停時突入電流特性

Inrush current characteristics

Same as inrush current waveform

(15) 入力電流波形

Input current waveform

Same as inrush current waveform

(16) リーク電流特性

Leakage current characteristics

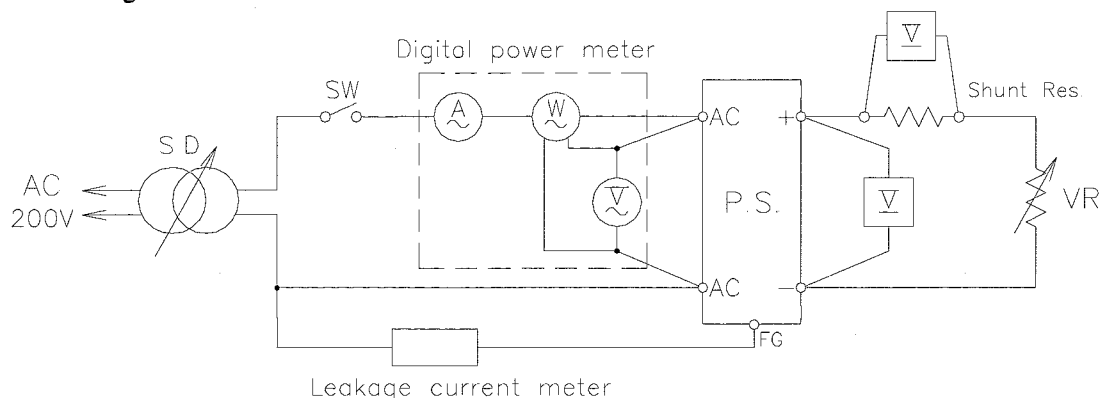

NOTE For HIOKI TYPE 3155
Built to meet IEC60950 (1991-10) + am4 (1996-07)

(17) 出力リップル、ノイズ波形

Output ripple and noise waveform

(a) Normal Mode

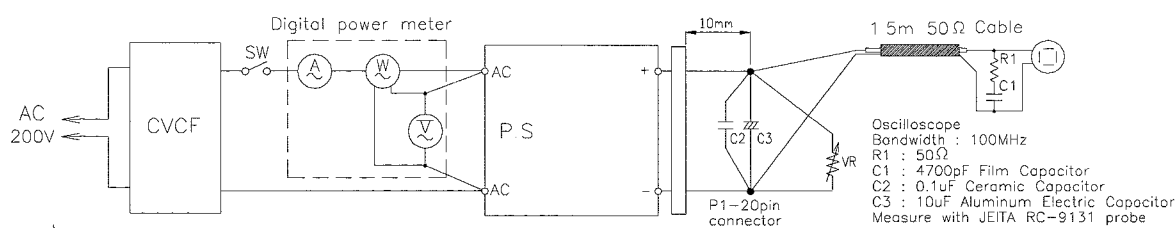

(b) Normal + Common Mode

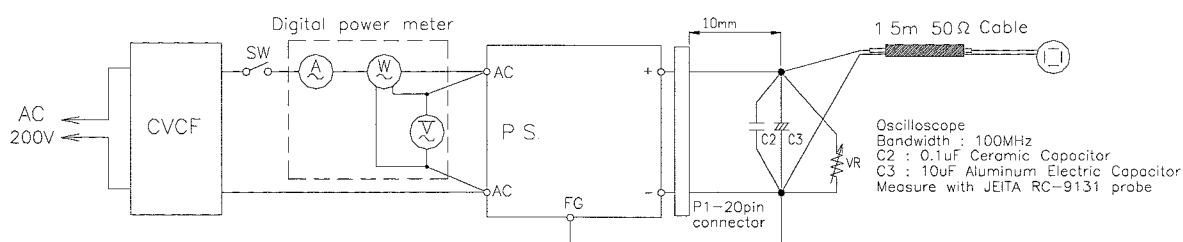

(18) EMI 特性
Electro-Magnetic Interference characteristics

(a) 雑音端子電圧 (帰還ノイズ)
Conducted Emission Noise

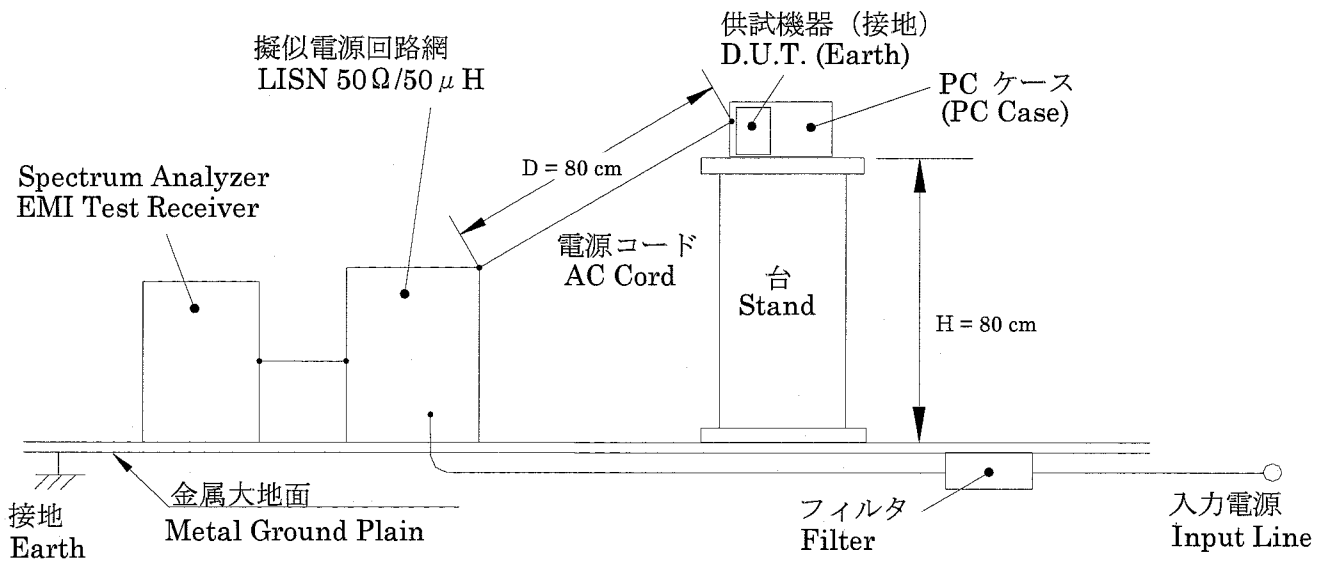

(b) 雑音電界強度 (輻射ノイズ)
Radiated Emission Noise

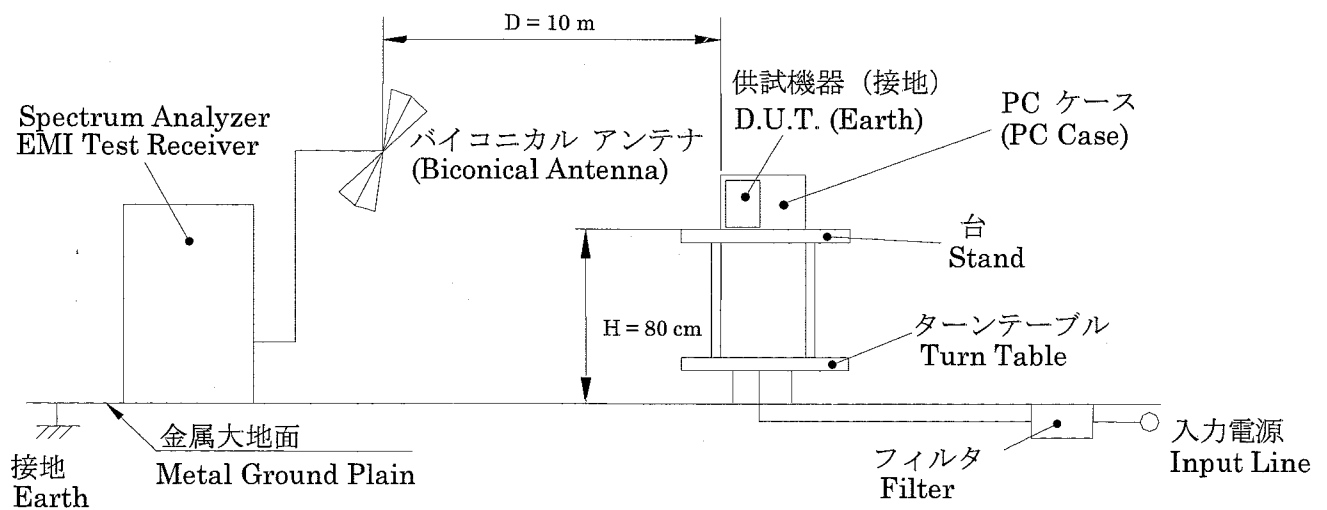

1.2 使用測定機器 List of equipment used

	EQUIPMENT USED	MANUFACTURER	MODEL NO.
1	OSCILLOSCOPE	HITACHI DENSHI	V-1565
2	DIGITAL STORAGE OSCILLOSCOPE	TEKTRONIX	TDS540C
3	DIGITAL MULTIMETER	AGILENT TECHNOLOGY	34970A
4	DIGITAL POWER METER	YOKOGAWA ELECT.	WT210
5	SHUNT RESISTOR	DAIICHI	TYPE DS
6	CURRENT PROBE/AMPLIFIER	TEKTRONIX	A6303/AM503B
7	DYNAMIC DUMMY LOAD	TAKASAGO	FK-600L/400L/200L
8	CVCF	KIKUSUI	PCR2000L
9	LEAKAGE CURRENT METER	HIOKI	3155
10	X-Y RECORDER	GRAPHTEC	WX3000
11	DC POWER SUPPLY	SHOWA	342
12	DYNAMIC DIP SIMULATOR	TAKAMISAWA	PSA-210
13	CONTROLLED TEMP. CHAMBER	ESPEC	PL-4KP
14	SPECTRUM ANALYZER (CE)	AGILENT TECHNOLOGY	E4401B
15	EMI TEST RECEIVER (CE)	SCHWARZBECK	FCKL1528
16	LISN	KYORITSU DENSHI	KNW-407
17	SPECTRUM ANALYZER (RE)	ADVANTEST	R3261C
18	EMI TEST RECEIVER (RE)	SCHWARZBECK	FCVU1534
19	ANTENNA(BICONICAL ANTENNA)	SCHWARZBECK	BBA9106

1.3 負荷条件 Load condition

負荷条件 Load condition	負荷率 Rate	出力電流 / I _o					出力電力 P _o (W)
		+3.3V (A)	+5.0V (A)	+12.0V (A)	-12.0V (A)	+5.0VSB (A)	
SB	100%	--	--	--	--	2.0	10.0
FL*/PL*	Min	0.0	0.5	0.0	0.0	0.0	2.5
FL1	100%	16.0	19.5	11.2	0.5	2.0	300.0
FL2		7.6	25.0	11.2	0.5	2.0	
FL3		10.0	14.2	15.0	0.5	2.0	
PL1	100%	28.0	20.6	11.1	0.8	2.5	350.0
PL2		13.7	30.0	11.1	0.8	2.5	
PL3		10.0	12.2	19.5	0.8	2.5	

Peak power interval : Peak power 5sec, interval 3 minutes.

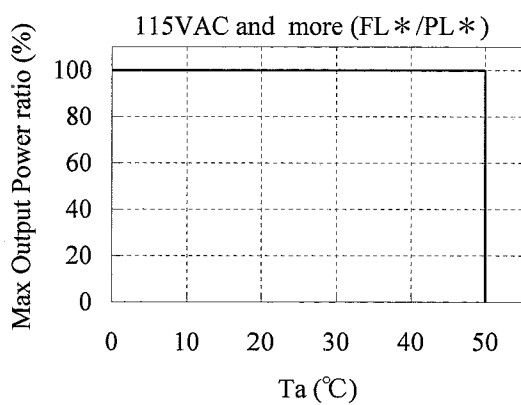
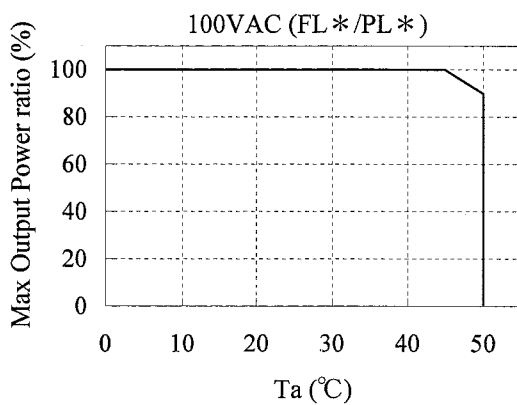
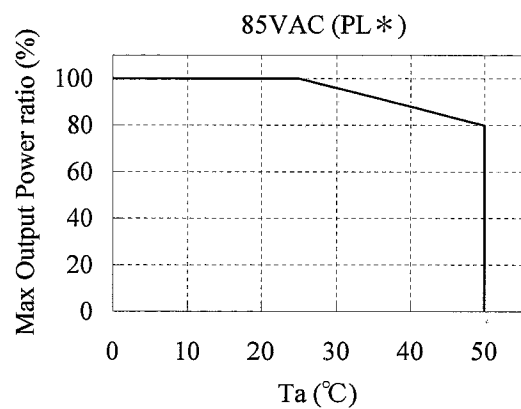
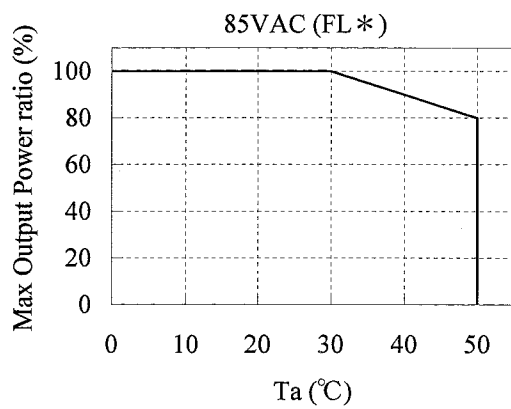

2.特性データ Characteristics

On line

2.1 静特性 Steady state data

(1) 入力、負荷、温度変動 Regulation - line and load, temperature drift

+3.3V

1.Regulation - line and load

Condition Ta : 25°C

Iout \ Vin		85VAC	100VAC	240VAC	265VAC	line regulation	
FL1	Min	3.395V	3.395V	3.395V	3.395V	0mV	0.00%
	60%	3.324V	3.324V	3.324V	3.324V	0mV	0.00%
	100%	3.276V	3.276V	3.276V	3.276V	0mV	0.00%
PL1	Peak	3.232V	3.231V	3.231V	3.231V	1mV	0.03%
Maximum load regulation (FL1 Only)		119mV	119mV	119mV	119mV		
		3.61%	3.61%	3.61%	3.61%		
Peak load regulation (FL1 & PL1)		163mV	164mV	164mV	164mV		
		4.94%	4.97%	4.97%	4.97%		

2. Temperature drift

Conditions Vin=115VAC

Io = 100%

Ta	0°C	+25°C	+50°C	temperature stability
Vo	3.281V	3.276V	3.265V	16mV 0.48%

+5V

1.Regulation - line and load

Condition Ta : 25°C

Iout \ Vin		85VAC	100VAC	240VAC	265VAC	line regulation	
FL1	Min	5.155V	5.155V	5.155V	5.155V	0mV	0.00%
	60%	5.057V	5.057V	5.057V	5.057V	0mV	0.00%
	100%	4.982V	4.982V	4.982V	4.982V	0mV	0.00%
PL1	Peak	4.949V	4.949V	4.949V	4.949V	0mV	0.00%
Maximum load regulation (FL1 Only)		173mV	173mV	173mV	173mV		
		3.46%	3.46%	3.46%	3.46%		
Peak load regulation (FL1 & PL1)		206mV	206mV	206mV	206mV		
		4.12%	4.12%	4.12%	4.12%		

2. Temperature drift

Conditions Vin=115VAC

Io = 100%

Ta	0°C	+25°C	+50°C	temperature stability
Vo	4.977V	4.982V	4.980V	5mV 0.10%

+12V

1.Regulation - line and load

Condition Ta : 25°C

Iout \ Vin		85VAC	100VAC	240VAC	265VAC	line regulation	
FL1	Min	12.197V	12.197V	12.198V	12.197V	1mV	0.01%
	60%	12.276V	12.276V	12.276V	12.276V	0mV	0.00%
	100%	12.346V	12.346V	12.347V	12.347V	1mV	0.01%
PL1	Peak	12.421V	12.423V	12.423V	12.424V	3mV	0.03%
Maximum load regulation (FL1 Only)		149mV	149mV	149mV	150mV		
		1.24%	1.24%	1.24%	1.25%		
Peak load regulation (FL1 & PL1)		224mV	226mV	225mV	227mV		
		1.87%	1.88%	1.88%	1.89%		

2. Temperature drift

Conditions Vin=115VAC

Io = 100%

Ta	0°C	+25°C	+50°C	temperature stability
Vo	12.307V	12.346V	12.381V	74mV 0.62%

2.特性データ Characteristics

On line

2.1 静特性 Steady state data

(1) 入力、負荷、温度変動 Regulation - line and load, temperature drift

-12V

1.Regulation - line and load

Condition Ta : 25°C

Iout \ Vin		85VAC	100VAC	240VAC	265VAC	line regulation	
FL1	Min	-12.028V	-12.027V	-12.025V	-12.025V	3mV	0.03%
	60%	-11.880V	-11.880V	-11.880V	-11.880V	0mV	0.00%
	100%	-11.826V	-11.826V	-11.826V	-11.826V	0mV	0.00%
PL1	Peak	-11.736V	-11.736V	-11.742V	-11.751V	15mV	0.12%
Maximum load regulation (FL1 Only)		202mV	201mV	199mV	199mV		
		1.68%	1.67%	1.66%	1.66%		
Peak load regulation (FL1 & PL1)		292mV	291mV	283mV	274mV		
		2.43%	2.42%	2.36%	2.28%		

2. Temperature drift

Conditions Vin=115VAC

Io = 100%

Ta	0°C	+25°C	+50°C	temperature stability	
Vo	-11.841V	-11.826V	-11.845V	19mV	0.16%

+5VSB

1.Regulation - line and load

Condition Ta : 25°C

Iout \ Vin		85VAC	100VAC	240VAC	265VAC	line regulation	
FL1	Min	5.149V	5.149V	5.149V	5.148V	1mV	0.02%
	60%	5.000V	4.999V	4.998V	4.997V	3mV	0.06%
	100%	4.918V	4.917V	4.917V	4.916V	2mV	0.04%
PL1	Peak	4.910V	4.908V	4.901V	4.901V	9mV	0.18%
Maximum load regulation (FL1 Only)		231mV	232mV	232mV	232mV		
		4.62%	4.64%	4.64%	4.64%		
Peak load regulation (FL1 & PL1)		239mV	241mV	248mV	247mV		
		4.78%	4.82%	4.96%	4.94%		

2. Temperature drift

Conditions Vin=115VAC

Io = 100%

Ta	0°C	+25°C	+50°C	temperature stability	
Vo	4.893V	4.917V	4.935V	42mV	0.84%

2.特性データ Characteristics

Off line

2.1 静特性 Steady state data

(1) 入力、負荷、温度変動 Regulation - line and load, temperature drift

+3.3V

1.Regulation - line and load

Condition Ta : 25°C

Iout \ Vin		20VDC	24VDC	line regulation	
FL1	Min	3.396V	3.396V	0mV	0.00%
	60%	3.326V	3.326V	0mV	0.00%
	100%	3.280V	3.280V	0mV	0.00%
PL1	Peak	3.235V	3.235V	0mV	0.00%
Maximum load regulation (FL1 Only)		116mV	116mV		
		3.52%	3.52%		
Peak load regulation (FL1 & PL1)		161mV	161mV		
		4.88%	4.88%		

2. Temperature drift

Conditions Vin=24VDC

Io = 100%

Ta	0°C	+25°C	+50°C	temperature stability	
Vo	3.284V	3.280V	3.268V	16mV	0.48%

+5V

1.Regulation - line and load

Condition Ta : 25°C

Iout \ Vin		20VDC	24VDC	line regulation	
FL1	Min	5.154V	5.155V	1mV	0.02%
	60%	5.056V	5.056V	0mV	0.00%
	100%	4.983V	4.986V	3mV	0.06%
PL1	Peak	4.951V	4.955V	4mV	0.08%
Maximum load regulation (FL1 Only)		171mV	169mV		
		3.42%	3.38%		
Peak load regulation (FL1 & PL1)		203mV	200mV		
		4.06%	4.00%		

2. Temperature drift

Conditions Vin=24VDC

Io = 100%

Ta	0°C	+25°C	+50°C	temperature stability	
Vo	4.979V	4.986V	4.984V	7mV	0.14%

+12V

1.Regulation - line and load

Condition Ta : 25°C

Iout \ Vin		20VDC	24VDC	line regulation	
FL1	Min	12.185V	12.196V	11mV	0.09%
	60%	12.276V	12.275V	1mV	0.01%
	100%	12.345V	12.335V	10mV	0.08%
PL1	Peak	12.422V	12.411V	11mV	0.09%
Maximum load regulation (FL1 Only)		160mV	139mV		
		1.33%	1.16%		
Peak load regulation (FL1 & PL1)		237mV	215mV		
		1.98%	1.79%		

2. Temperature drift

Conditions Vin=24VDC

Io = 100%

Ta	0°C	+25°C	+50°C	temperature stability	
Vo	12.288V	12.335V	12.367V	79mV	0.66%

2.特性データ Characteristics

Off line

2.1 静特性 Steady state data

(1) 入力、負荷、温度変動 Regulation - line and load, temperature drift

-12V

1.Regulation - line and load

Condition Ta : 25°C

Iout \ Vin		20VDC	24VDC	line regulation	
FL1	Min	-12.004V	-12.014V	10mV	0.08%
	60%	-11.939V	-11.944V	5mV	0.04%
	100%	-11.885V	-11.891V	6mV	0.05%
PL1	Peak	-11.785V	-11.775V	10mV	0.08%
Maximum load regulation (FL1 Only)		119mV	123mV		
		0.99%	1.02%		
Peak load regulation (FL1 & PL1)		219mV	239mV		
		1.83%	1.99%		

2. Temperature drift

Conditions Vin=24VDC

Io = 100%

Ta	0°C	+25°C	+50°C	temperature stability	
Vo	-11.883V	-11.891V	-11.931V	48mV	0.40%

+5VSB

1.Regulation - line and load

Condition Ta : 25°C

Iout \ Vin		20VDC	24VDC	line regulation	
FL1	Min	5.150V	5.148V	2mV	0.04%
	60%	5.021V	4.993V	28mV	0.56%
	100%	4.943V	4.933V	10mV	0.20%
PL1	Peak	4.941V	4.910V	31mV	0.62%
Maximum load regulation (FL1 Only)		207mV	215mV		
		4.14%	4.30%		
Peak load regulation (FL1 & PL1)		209mV	238mV		
		4.18%	4.76%		

2. Temperature drift

Conditions Vin=24VDC

Io = 100%

Ta	0°C	+25°C	+50°C	temperature stability	
Vo	4.888V	4.933V	4.995V	107mV	2.14%

2.特性データ Characteristics

On line

2.1 静特性 Steady state data

(1) 入力、負荷、温度変動 Regulation - line and load, temperature drift

+3.3V

1.Regulation - line and load

Condition Ta : 25°C

Iout \ Vin		85VAC	100VAC	240VAC	265VAC	line regulation	
FL2	Min	3.395V	3.395V	3.395V	3.395V	0mV	0.00%
	60%	3.334V	3.334V	3.334V	3.334V	0mV	0.00%
	100%	3.294V	3.293V	3.293V	3.293V	1mV	0.03%
PL2	Peak	3.263V	3.262V	3.262V	3.262V	1mV	0.03%
Maximum load regulation (FL2 Only)		101mV	102mV	102mV	102mV		
		3.06%	3.09%	3.09%	3.09%		
Peak load regulation (FL2 & PL2)		132mV	133mV	133mV	133mV		
		4.00%	4.03%	4.03%	4.03%		

2. Temperature drift

Conditions Vin=115VAC

Io = 100%

Ta	0°C	+25°C	+50°C	temperature stability
Vo	3.298V	3.293V	3.282V	16mV 0.48%

+5V

1.Regulation - line and load

Condition Ta : 25°C

Iout \ Vin		85VAC	100VAC	240VAC	265VAC	line regulation	
FL2	Min	5.155V	5.155V	5.155V	5.155V	0mV	0.00%
	60%	5.047V	5.047V	5.047V	5.047V	0mV	0.00%
	100%	4.965V	4.965V	4.965V	4.965V	0mV	0.00%
PL2	Peak	4.920V	4.920V	4.920V	4.920V	0mV	0.00%
Maximum load regulation (FL2 Only)		190mV	190mV	190mV	190mV		
		3.80%	3.80%	3.80%	3.80%		
Peak load regulation (FL2 & PL2)		235mV	235mV	235mV	235mV		
		4.70%	4.70%	4.70%	4.70%		

2. Temperature drift

Conditions Vin=115VAC

Io = 100%

Ta	0°C	+25°C	+50°C	temperature stability
Vo	4.962V	4.965V	4.962V	3mV 0.06%

+12V

1.Regulation - line and load

Condition Ta : 25°C

Iout \ Vin		85VAC	100VAC	240VAC	265VAC	line regulation	
FL2	Min	12.178V	12.179V	12.188V	12.187V	10mV	0.08%
	60%	12.369V	12.369V	12.369V	12.369V	0mV	0.00%
	100%	12.511V	12.512V	12.514V	12.514V	3mV	0.03%
PL2	Peak	12.699V	12.707V	12.709V	12.709V	10mV	0.08%
Maximum load regulation (FL2 Only)		333mV	333mV	326mV	327mV		
		2.77%	2.78%	2.72%	2.73%		
Peak load regulation (FL2 & PL2)		521mV	528mV	521mV	522mV		
		4.34%	4.40%	4.34%	4.35%		

2. Temperature drift

Conditions Vin=115VAC

Io = 100%

Ta	0°C	+25°C	+50°C	temperature stability
Vo	12.457V	12.513V	12.567V	110mV 0.92%

2.特性データ Characteristics

On line

2.1 静特性 Steady state data

(1) 入力、負荷、温度変動 Regulation - line and load, temperature drift

-12V

1.Regulation - line and load

Condition Ta : 25°C

Iout \ Vin		85VAC	100VAC	240VAC	265VAC	line regulation	
FL2	Min	-12.017V	-12.018V	-12.019V	-12.019V	2mV	0.02%
	60%	-11.883V	-11.883V	-11.883V	-11.883V	0mV	0.00%
	100%	-11.817V	-11.819V	-11.819V	-11.819V	2mV	0.02%
PL2	Peak	-11.737V	-11.734V	-11.732V	-11.731V	6mV	0.05%
Maximum load regulation (FL2 Only)		200mV	199mV	200mV	200mV		
		1.67%	1.66%	1.67%	1.67%		
Peak load regulation (FL2 & PL2)		280mV	284mV	287mV	288mV		
		2.33%	2.37%	2.39%	2.40%		

2. Temperature drift

Conditions Vin=115VAC

Io = 100%

Ta	0°C	+25°C	+50°C	temperature stability	
Vo	-11.845V	-11.819V	-11.835V	26mV	0.22%

+5VSB

1.Regulation - line and load

Condition Ta : 25°C

Iout \ Vin		85VAC	100VAC	240VAC	265VAC	line regulation	
FL2	Min	5.149V	5.149V	5.149V	5.149V	0mV	0.00%
	60%	5.004V	5.003V	5.002V	5.002V	2mV	0.04%
	100%	4.924V	4.923V	4.923V	4.923V	1mV	0.02%
PL2	Peak	4.923V	4.918V	4.913V	4.913V	10mV	0.20%
Maximum load regulation (FL2 Only)		225mV	226mV	226mV	226mV		
		4.50%	4.52%	4.52%	4.52%		
Peak load regulation (FL2 & PL2)		226mV	231mV	236mV	236mV		
		4.52%	4.62%	4.72%	4.72%		

2. Temperature drift

Conditions Vin=115VAC

Io = 100%

Ta	0°C	+25°C	+50°C	temperature stability	
Vo	4.899V	4.923V	4.941V	42mV	0.84%

2.特性データ Characteristics

Off line

2.1 静特性 Steady state data

(1) 入力、負荷、温度変動 Regulation - line and load, temperature drift

+3.3V

1.Regulation - line and load

Condition Ta : 25°C

Iout \ Vin		20VDC	24VDC	line regulation	
FL2	Min	3.395V	3.395V	0mV	0.00%
	60%	3.319V	3.318V	1mV	0.03%
	100%	3.268V	3.267V	1mV	0.03%
PL2	Peak	3.265V	3.265V	0mV	0.00%
Maximum load regulation (FL2 Only)		127mV	128mV		
		3.85%	3.88%		
Peak load regulation (FL2 & PL2)		130mV	130mV		
		3.94%	3.94%		

2. Temperature drift

Conditions Vin=24VDC

Io = 100%

Ta	0°C	+25°C	+50°C	temperature stability	
Vo	3.273V	3.267V	3.254V	19mV	0.58%

+5V

1.Regulation - line and load

Condition Ta : 25°C

Iout \ Vin		20VDC	24VDC	line regulation	
FL2	Min	5.155V	5.155V	0mV	0.00%
	60%	5.036V	5.037V	1mV	0.02%
	100%	4.949V	4.951V	2mV	0.04%
PL2	Peak	4.922V	4.925V	3mV	0.06%
Maximum load regulation (FL2 Only)		206mV	204mV		
		4.12%	4.08%		
Peak load regulation (FL2 & PL2)		233mV	230mV		
		4.66%	4.60%		

2. Temperature drift

Conditions Vin=24VDC

Io = 100%

Ta	0°C	+25°C	+50°C	temperature stability	
Vo	4.949V	4.951V	4.945V	6mV	0.12%

+12V

1.Regulation - line and load

Condition Ta : 25°C

Iout \ Vin		20VDC	24VDC	line regulation	
FL2	Min	12.169V	12.177V	8mV	0.07%
	60%	12.378V	12.375V	3mV	0.03%
	100%	12.525V	12.516V	9mV	0.08%
PL2	Peak	12.688V	12.676V	12mV	0.10%
Maximum load regulation (FL2 Only)		356mV	339mV		
		2.97%	2.83%		
Peak load regulation (FL2 & PL2)		519mV	499mV		
		4.33%	4.16%		

2. Temperature drift

Conditions Vin=24VDC

Io = 100%

Ta	0°C	+25°C	+50°C	temperature stability	
Vo	12.461V	12.516V	12.565V	104mV	0.87%

2.特性データ Characteristics

Off line

2.1 静特性 Steady state data

(1) 入力、負荷、温度変動 Regulation - line and load, temperature drift

-12V

1.Regulation - line and load

Condition Ta : 25°C

Iout \ Vin		20VDC	24VDC	line regulation	
FL2	Min	-11.996V	-11.995V	1mV	0.01%
	60%	-11.943V	-11.942V	1mV	0.01%
	100%	-11.895V	-11.894V	1mV	0.01%
PL2	Peak	-11.776V	-11.778V	2mV	0.02%
Maximum load regulation (FL2 Only)		101mV	101mV		
		0.84%	0.84%		
Peak load regulation (FL2 & PL2)		220mV	217mV		
		1.83%	1.81%		

2. Temperature drift

Conditions Vin=24VDC

Io = 100%

Ta	0°C	+25°C	+50°C	temperature stability	
Vo	-11.896V	-11.894V	-11.895V	2mV	0.02%

+5VSB

1.Regulation - line and load

Condition Ta : 25°C

Iout \ Vin		20VDC	24VDC	line regulation	
FL2	Min	5.151V	5.154V	3mV	0.06%
	60%	5.065V	5.058V	7mV	0.14%
	100%	4.942V	4.926V	16mV	0.32%
PL2	Peak	4.949V	4.919V	30mV	0.60%
Maximum load regulation (FL2 Only)		209mV	228mV		
		4.18%	4.56%		
Peak load regulation (FL2 & PL2)		209mV	235mV		
		4.18%	4.70%		

2. Temperature drift

Conditions Vin=24VDC

Io = 100%

Ta	0°C	+25°C	+50°C	temperature stability	
Vo	4.889V	4.926V	4.993V	104mV	2.08%

2.特性データ Characteristics

On line

2.1 静特性 Steady state data

(1) 入力、負荷、温度変動 Regulation - line and load, temperature drift

+3.3V

1.Regulation - line and load

Condition Ta : 25°C

Iout \ Vin		85VAC	100VAC	240VAC	265VAC	line regulation	
FL3	Min	3.395V	3.395V	3.395V	3.395V	0mV	0.00%
	60%	3.338V	3.338V	3.338V	3.338V	0mV	0.00%
	100%	3.300V	3.300V	3.300V	3.299V	1mV	0.03%
PL3	Peak	3.294V	3.293V	3.293V	3.293V	1mV	0.03%
Maximum load regulation (FL3 Only)		95mV	95mV	95mV	96mV		
		2.88%	2.88%	2.88%	2.91%		
Peak load regulation (FL3 & PL3)		101mV	102mV	102mV	102mV		
		3.06%	3.09%	3.09%	3.09%		

2. Temperature drift

Conditions Vin=115VAC

Io = 100%

Ta	0°C	+25°C	+50°C	temperature stability	
Vo	3.304V	3.300V	3.289V	15mV	0.45%

+5V

1.Regulation - line and load

Condition Ta : 25°C

Iout \ Vin		85VAC	100VAC	240VAC	265VAC	line regulation	
FL3	Min	5.155V	5.155V	5.155V	5.155V	0mV	0.00%
	60%	5.077V	5.077V	5.077V	5.077V	0mV	0.00%
	100%	5.017V	5.017V	5.017V	5.017V	0mV	0.00%
PL3	Peak	5.017V	5.016V	5.017V	5.017V	1mV	0.02%
Maximum load regulation (FL3 Only)		138mV	138mV	138mV	138mV		
		2.76%	2.76%	2.76%	2.76%		
Peak load regulation (FL3 & PL3)		138mV	139mV	138mV	138mV		
		2.76%	2.78%	2.76%	2.76%		

2. Temperature drift

Conditions Vin=115VAC

Io = 100%

Ta	0°C	+25°C	+50°C	temperature stability	
Vo	5.011V	5.017V	5.018V	7mV	0.14%

+12V

1.Regulation - line and load

Condition Ta : 25°C

Iout \ Vin		85VAC	100VAC	240VAC	265VAC	line regulation	
FL3	Min	12.178V	12.180V	12.188V	12.188V	10mV	0.08%
	60%	12.085V	12.085V	12.084V	12.084V	1mV	0.01%
	100%	11.995V	11.995V	11.993V	11.992V	3mV	0.02%
PL3	Peak	11.735V	11.729V	11.724V	11.724V	11mV	0.09%
Maximum load regulation (FL3 Only)		183mV	185mV	195mV	196mV		
		1.53%	1.54%	1.63%	1.63%		
Peak load regulation (FL3 & PL3)		443mV	451mV	464mV	464mV		
		3.69%	3.76%	3.87%	3.87%		

2. Temperature drift

Conditions Vin=115VAC

Io = 100%

Ta	0°C	+25°C	+50°C	temperature stability	
Vo	11.983V	11.994V	11.986V	11mV	0.09%

2.特性データ Characteristics

On line

2.1 静特性 Steady state data

(1) 入力、負荷、温度変動 Regulation - line and load, temperature drift

-12V

1.Regulation - line and load

Condition Ta : 25°C

Iout \ Vin		85VAC	100VAC	240VAC	265VAC	line regulation	
FL3	Min	-12.015V	-12.016V	-12.018V	-12.018V	3mV	0.03%
	60%	-11.821V	-11.824V	-11.829V	-11.830V	9mV	0.08%
	100%	-11.810V	-11.810V	-11.805V	-11.805V	5mV	0.04%
PL3	Peak	-11.721V	-11.721V	-11.723V	-11.723V	2mV	0.02%
Maximum load regulation (FL3 Only)		205mV	206mV	213mV	213mV		
		1.71%	1.72%	1.78%	1.78%		
Peak load regulation (FL3 & PL3)		294mV	295mV	295mV	295mV		
		2.45%	2.46%	2.46%	2.46%		

2. Temperature drift

Conditions Vin=115VAC

Io = 100%

Ta	0°C	+25°C	+50°C	temperature stability	
Vo	-11.837V	-11.809V	-11.824V	28mV	0.23%

+5VSB

1.Regulation - line and load

Condition Ta : 25°C

Iout \ Vin		85VAC	100VAC	240VAC	265VAC	line regulation	
FL3	Min	5.149V	5.149V	5.149V	5.149V	0mV	0.00%
	60%	5.009V	5.008V	5.007V	5.007V	2mV	0.04%
	100%	4.933V	4.933V	4.932V	4.932V	1mV	0.02%
PL3	Peak	4.948V	4.945V	4.938V	4.937V	11mV	0.22%
Maximum load regulation (FL3 Only)		216mV	216mV	217mV	217mV		
		4.32%	4.32%	4.34%	4.34%		
Peak load regulation (FL3 & PL3)		216mV	216mV	217mV	217mV		
		4.32%	4.32%	4.34%	4.34%		

2. Temperature drift

Conditions Vin=115VAC

Io = 100%

Ta	0°C	+25°C	+50°C	temperature stability	
Vo	4.907V	4.933V	4.950V	43mV	0.86%

2.特性データ Characteristics

Off line

2.1 静特性 Steady state data

(1) 入力、負荷、温度変動 Regulation - line and load, temperature drift

+3.3V

1.Regulation - line and load

Condition Ta : 25°C

Iout \ Vin		20VDC	24VDC	line regulation	
FL3	Min	3.395V	3.395V	0mV	0.00%
	60%	3.339V	3.338V	1mV	0.03%
	100%	3.302V	3.302V	0mV	0.00%
PL3	Peak	3.296V	3.296V	0mV	0.00%
Maximum load regulation (FL3 Only)		93mV	93mV		
		2.82%	2.82%		
Peak load regulation (FL3 & PL3)		99mV	99mV		
		3.00%	3.00%		

2. Temperature drift

Conditions Vin=24VDC

Io = 100%

Ta	0°C	+25°C	+50°C	temperature stability	
Vo	3.305V	3.302V	3.290V	15mV	0.45%

+5V

1.Regulation - line and load

Condition Ta : 25°C

Iout \ Vin		20VDC	24VDC	line regulation	
FL3	Min	5.155V	5.156V	1mV	0.02%
	60%	5.077V	5.079V	2mV	0.04%
	100%	5.018V	5.020V	2mV	0.04%
PL3	Peak	5.017V	5.020V	3mV	0.06%
Maximum load regulation (FL3 Only)		137mV	136mV		
		2.74%	2.72%		
Peak load regulation (FL3 & PL3)		138mV	136mV		
		2.76%	2.72%		

2. Temperature drift

Conditions Vin=24VDC

Io = 100%

Ta	0°C	+25°C	+50°C	temperature stability	
Vo	5.013V	5.020V	5.019V	7mV	0.14%

+12V

1.Regulation - line and load

Condition Ta : 25°C

Iout \ Vin		20VDC	24VDC	line regulation	
FL3	Min	12.176V	12.172V	4mV	0.03%
	60%	12.084V	12.087V	3mV	0.03%
	100%	12.018V	12.019V	1mV	0.01%
PL3	Peak	11.761V	11.768V	7mV	0.06%
Maximum load regulation (FL3 Only)		158mV	153mV		
		1.32%	1.28%		
Peak load regulation (FL3 & PL3)		415mV	404mV		
		3.46%	3.37%		

2. Temperature drift

Conditions Vin=24VDC

Io = 100%

Ta	0°C	+25°C	+50°C	temperature stability	
Vo	12.004V	12.019V	12.009V	15mV	0.13%

2.特性データ Characteristics

Off line

2.1 静特性 Steady state data

(1) 入力、負荷、温度変動 Regulation - line and load, temperature drift

-12V

1.Regulation - line and load

Condition Ta : 25°C

Iout \ Vin		20VDC	24VDC	line regulation	
FL3	Min	-11.999V	-11.999V	0mV	0.00%
	60%	-11.929V	-11.929V	0mV	0.00%
	100%	-11.871V	-11.871V	0mV	0.00%
PL3	Peak	-11.756V	-11.756V	0mV	0.00%
Maximum load regulation (FL3 Only)		128mV	128mV		
		1.07%	1.07%		
Peak load regulation (FL3 & PL3)		243mV	243mV		
		2.03%	2.03%		

2. Temperature drift

Conditions Vin=24VDC

Io = 100%

Ta	0°C	+25°C	+50°C	temperature stability	
Vo	-11.873V	-11.871V	-11.869V	4mV	0.03%

+5VSB

1.Regulation - line and load

Condition Ta : 25°C

Iout \ Vin		20VDC	24VDC	line regulation	
FL3	Min	5.151V	5.149V	2mV	0.04%
	60%	5.043V	5.067V	24mV	0.48%
	100%	4.958V	4.947V	11mV	0.22%
PL3	Peak	4.974V	4.940V	34mV	0.68%
Maximum load regulation (FL3 Only)		193mV	202mV		
		3.86%	4.04%		
Peak load regulation (FL3 & PL3)		193mV	209mV		
		3.86%	4.18%		

2. Temperature drift

Conditions Vin=24VDC

Io = 100%

Ta	0°C	+25°C	+50°C	temperature stability	
Vo	4.910V	4.947V	5.029V	119mV	2.38%

2.特性データ Characteristics

On line

2.1 静特性 Steady state data

(1) 入力、負荷、温度変動 Regulation - line and load, temperature drift

+5VSB (Standby)

1.Regulation - line and load

Condition Ta : 25°C

Iout \ Vin		85VAC	100VAC	240VAC	265VAC	line regulation	
SB	Min	5.159V	5.159V	5.152V	5.149V	10mV	0.20%
	60%	5.123V	5.122V	5.109V	5.108V	15mV	0.30%
	100%	5.065V	5.066V	5.018V	5.019V	48mV	0.96%
Maximum load regulation (SB Only)		94mV	93mV	134mV	130mV		
		1.88%	1.86%	2.68%	2.60%		

2. Temperature drift

Conditions Vin=115VAC

Io = 100%

Ta	0°C	+25°C	+50°C	temperature stability	
Vo	4.983V	5.045V	5.102V	119mV	2.38%

2.1 (2) 出力電圧、リップル電圧対入力電圧
Output voltage and ripple voltage vs. input voltage

Conditions Iout : FL1
 Ta : 0°C -----
 : 25°C - - - - -
 : 50°C _____

On line

+3.3V

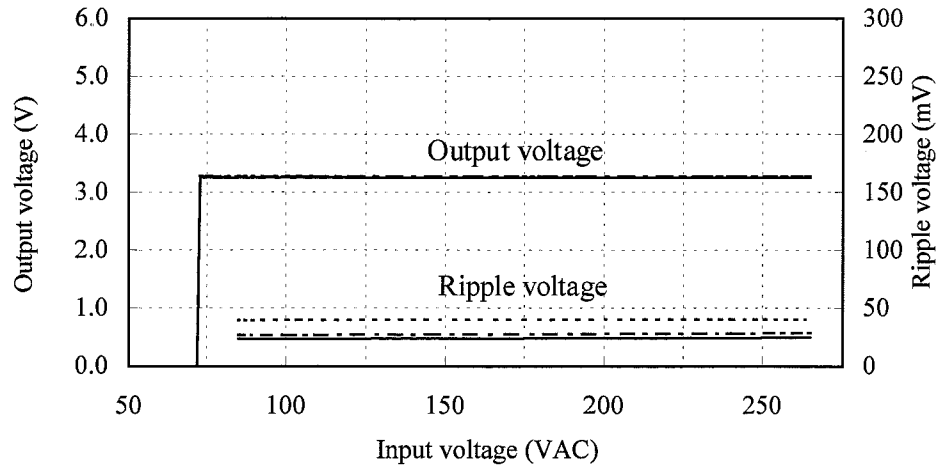

+5V

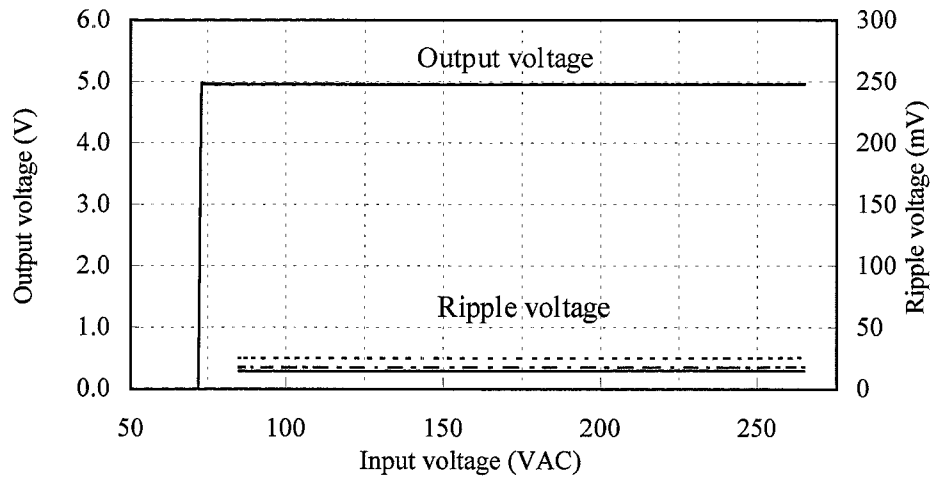

+12V

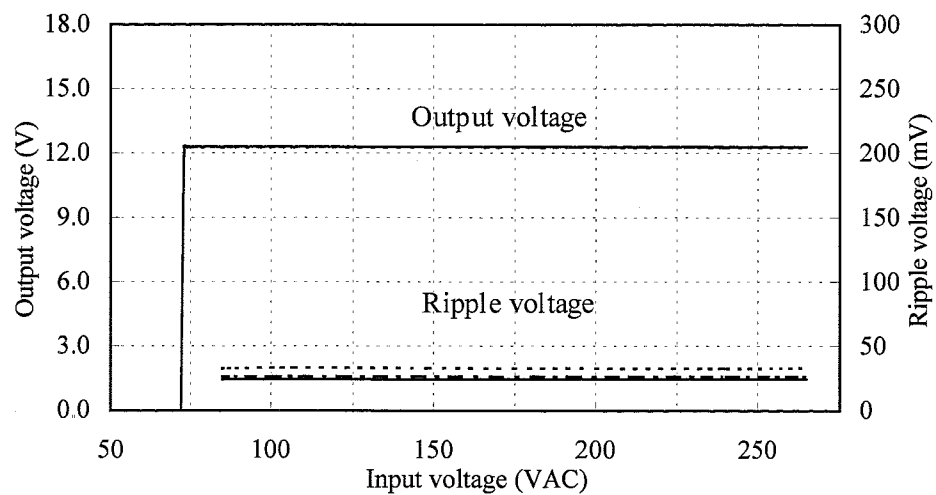

2.1 (2) 出力電圧、リップル電圧対入力電圧
Output voltage and ripple voltage vs. input voltage

Conditions Iout : FL1
Ta : 0°C -----
: 25°C - - - - -
: 50°C _____

On line
-12V

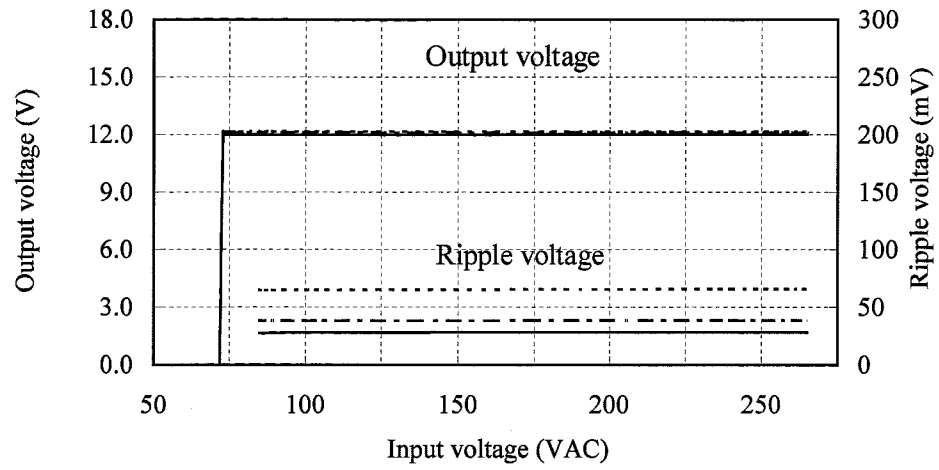

+5VSB

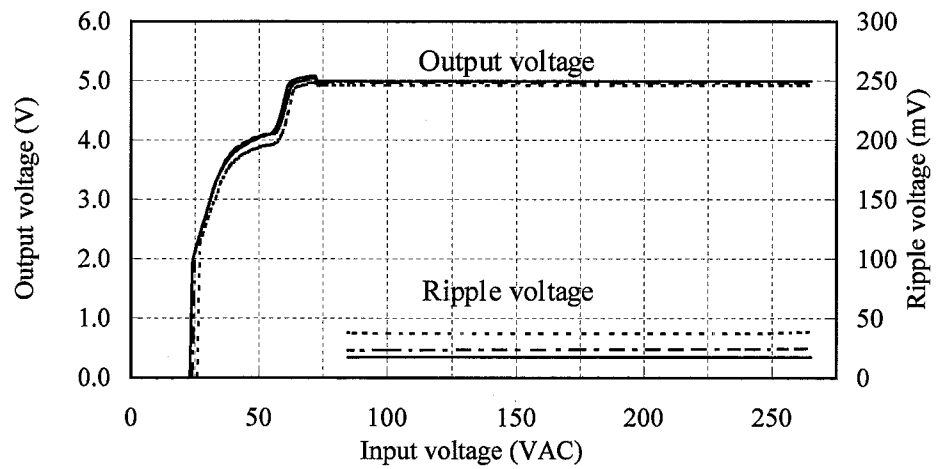

2.1 (2) 出力電圧対入力電圧
Output voltage vs. input voltage

Conditions Iout : FL1
 Ta : 0°C -----
 : 25°C - - - - -
 : 50°C _____

Off line

+3.3V

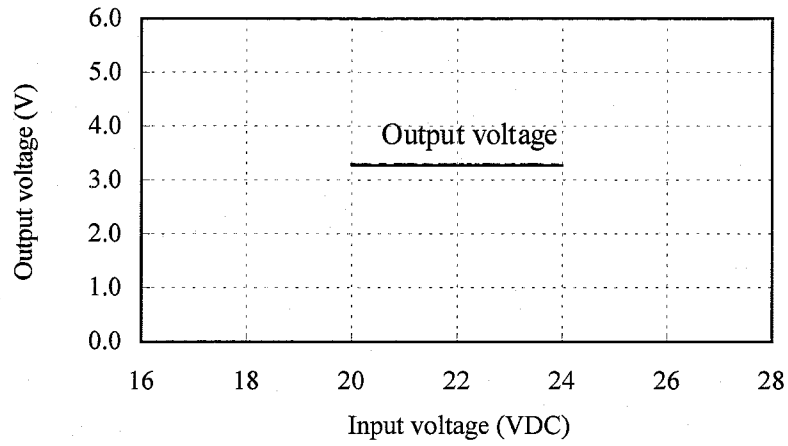

+5V

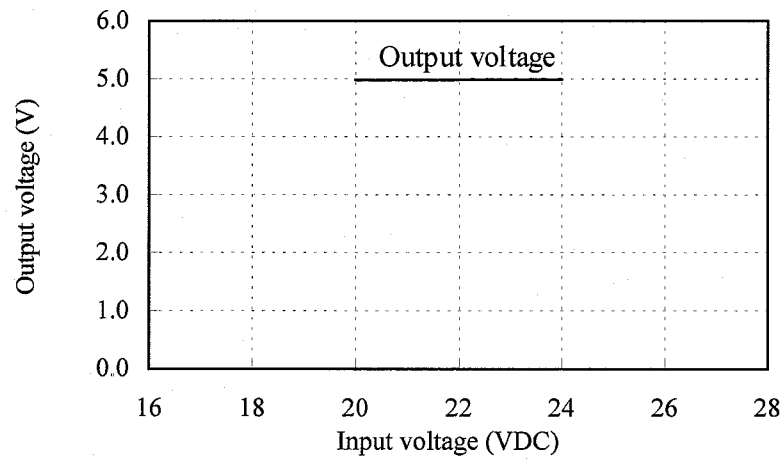

+12V

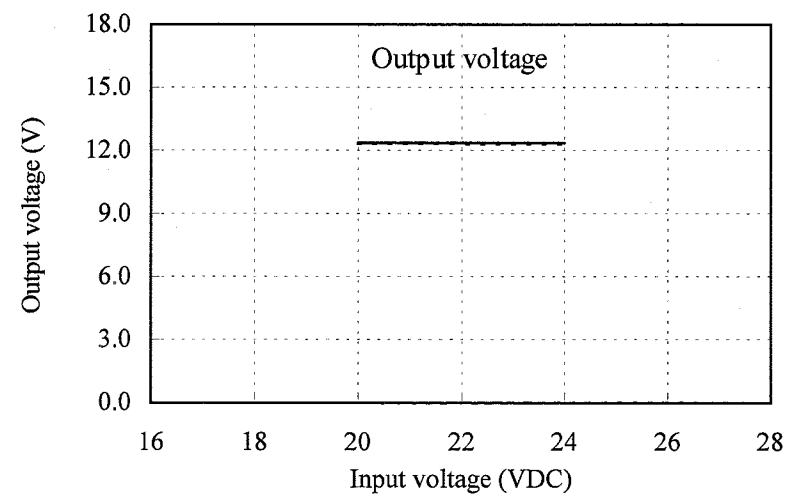

2.1 (2) 出力電圧対入力電圧
Output voltage vs. input voltage

Conditions Iout : FL1
 Ta : 0°C -----
 : 25°C - - - - -
 : 50°C _____

Off line

-12V

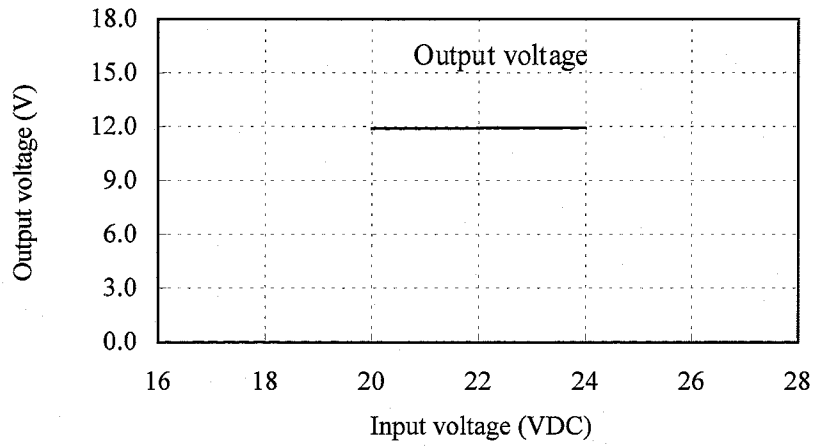

+5VSB

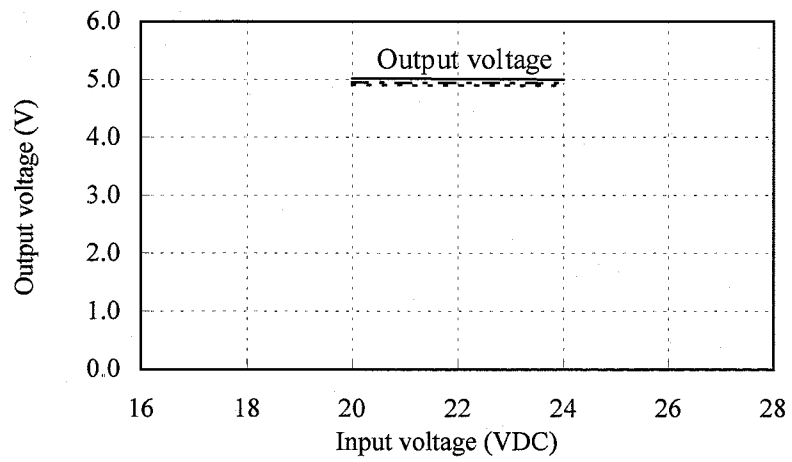

2.1 (2) 出力電圧、リップル電圧対入力電圧

Output voltage and ripple voltage vs. input voltage

Conditions Iout : FL2

Ta : 0°C -----
 : 25°C - - - - -
 : 50°C _____

On line

+3.3V

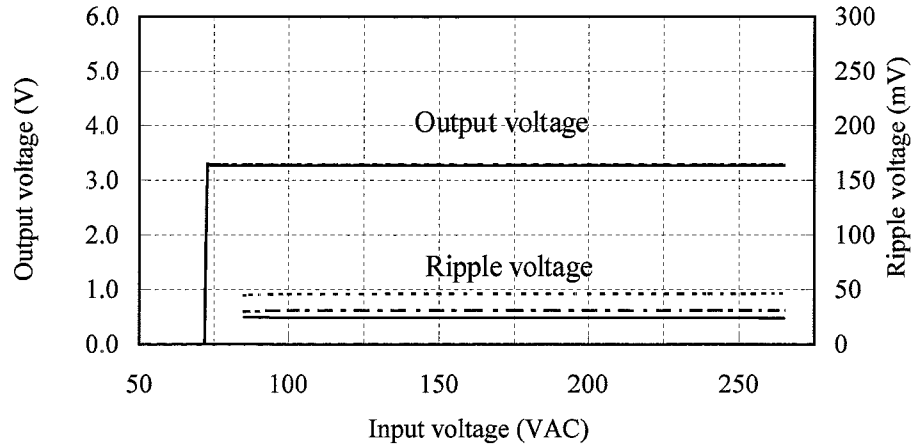

+5V

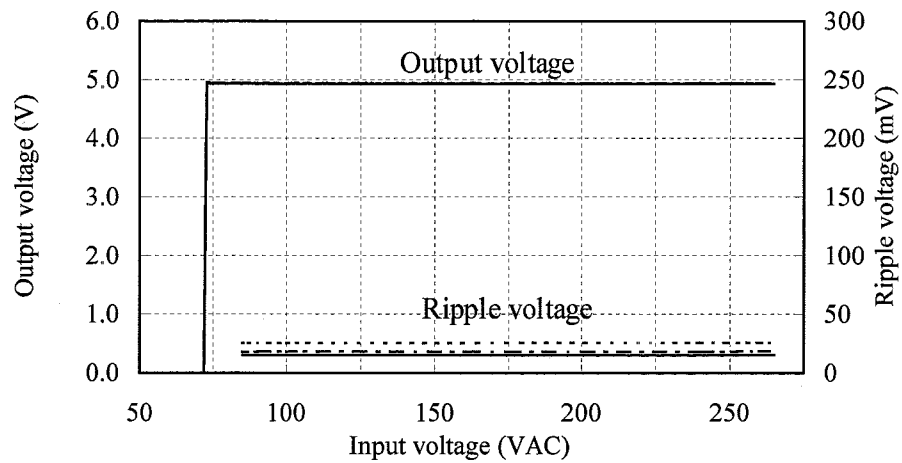

+12V

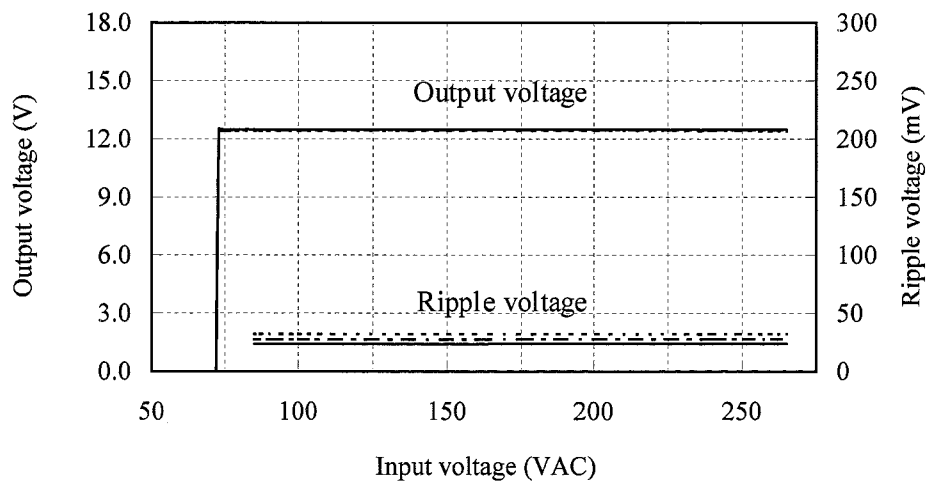

2.1 (2) 出力電圧、リップル電圧対入力電圧
Output voltage and ripple voltage vs. input voltage

Conditions Iout : FL2
 Ta : 0°C -----
 : 25°C - - - - -
 : 50°C _____

On line
 -12V

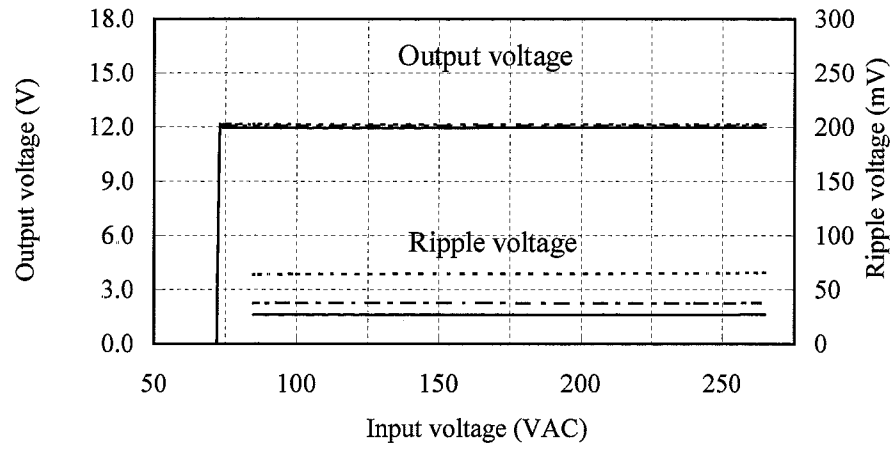

+5VSB

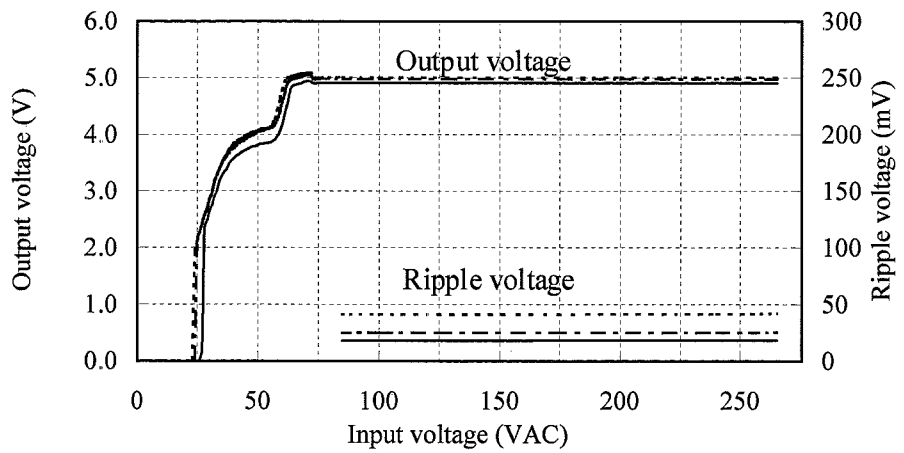

2.1 (2) 出力電圧対入力電圧
Output voltage vs. input voltage

Conditions Iout : FL2
 Ta : 0°C -----
 : 25°C - - - - -
 : 50°C _____

Off line

+3.3V

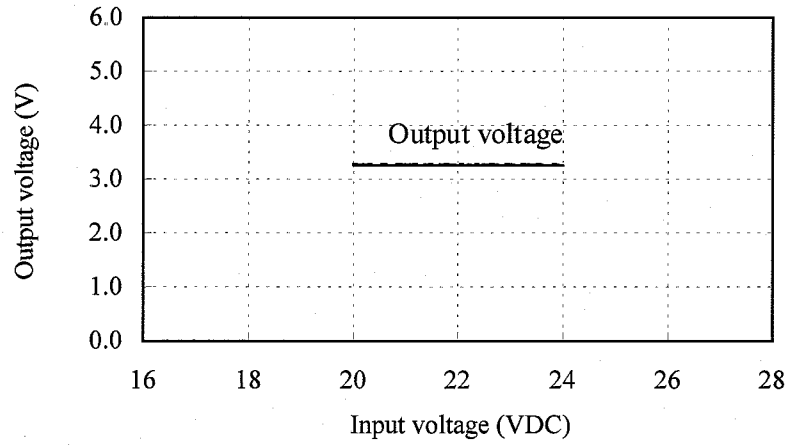

+5V

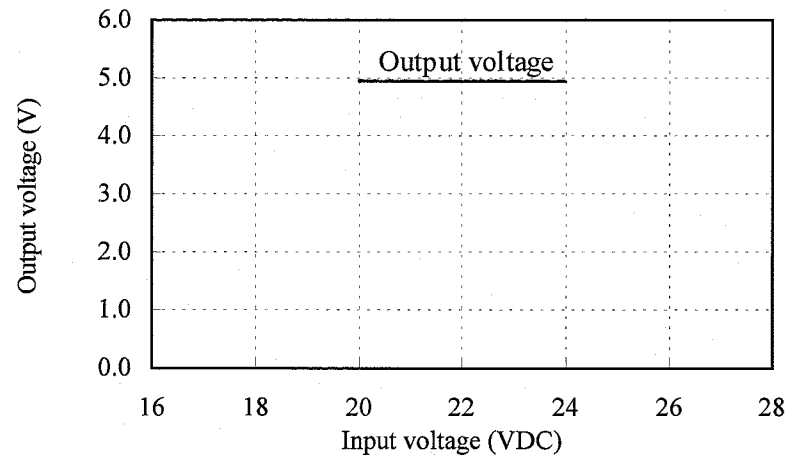

+12V

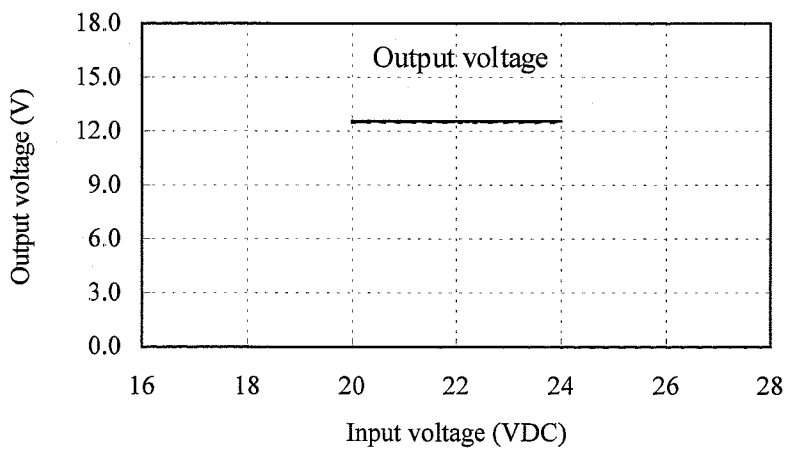

2.1 (2) 出力電圧対入力電圧

Output voltage vs. input voltage

Conditions Iout : FL2

Ta : 0°C -----
 : 25°C - - - - -
 : 50°C _____

Off line

-12V

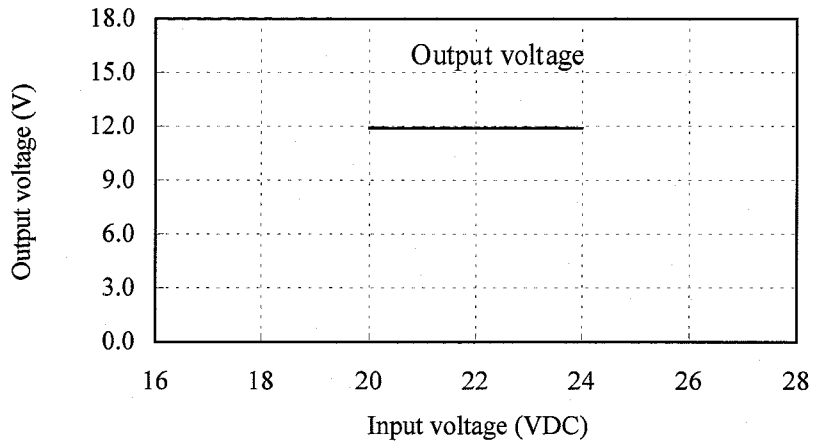

+5VSB

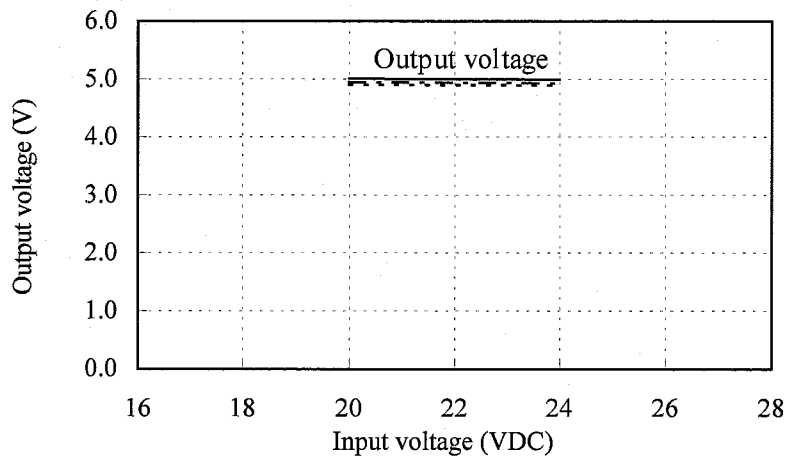

2.1 (2) 出力電圧、リップル電圧対入力電圧
Output voltage and ripple voltage vs. input voltage

Conditions Iout : FL3
 Ta : 0°C -----
 : 25°C - - - - -
 : 50°C _____

On line

+3.3V

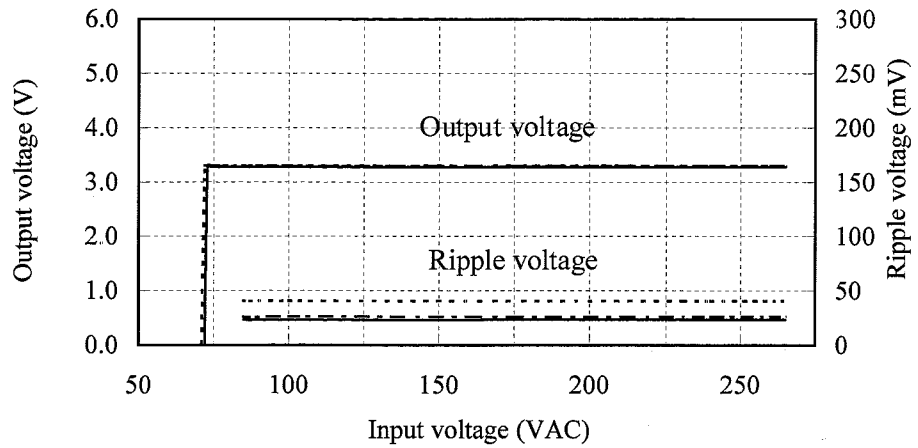

+5V

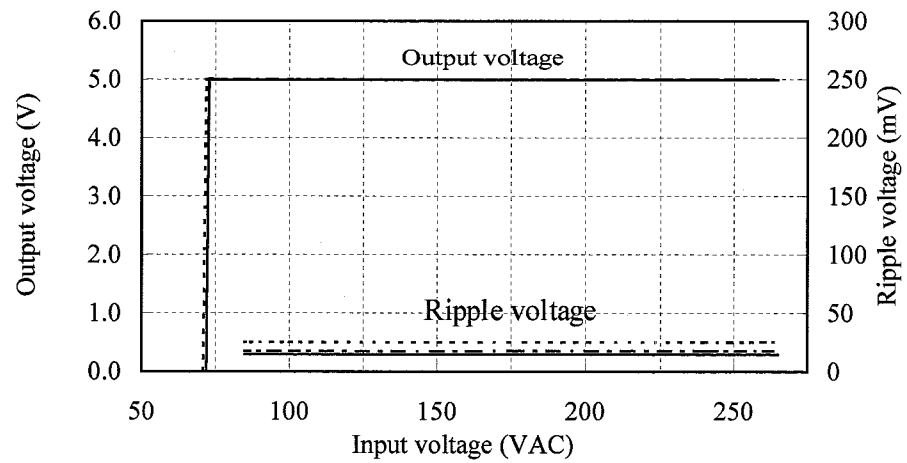

+12V

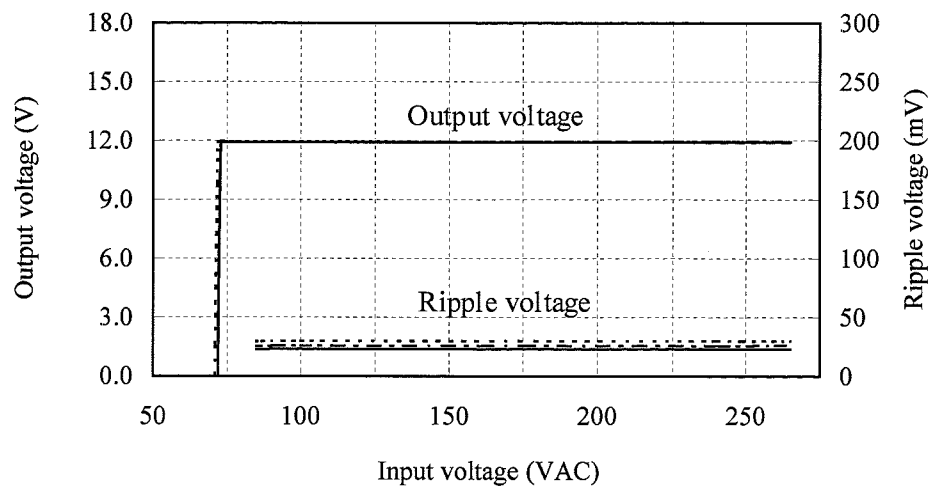

2.1 (2) 出力電圧、リップル電圧対入力電圧
Output voltage and ripple voltage vs. input voltage

Conditions Iout : FL3
 Ta : 0°C -----
 : 25°C -----
 : 50°C -----

On line
 -12V

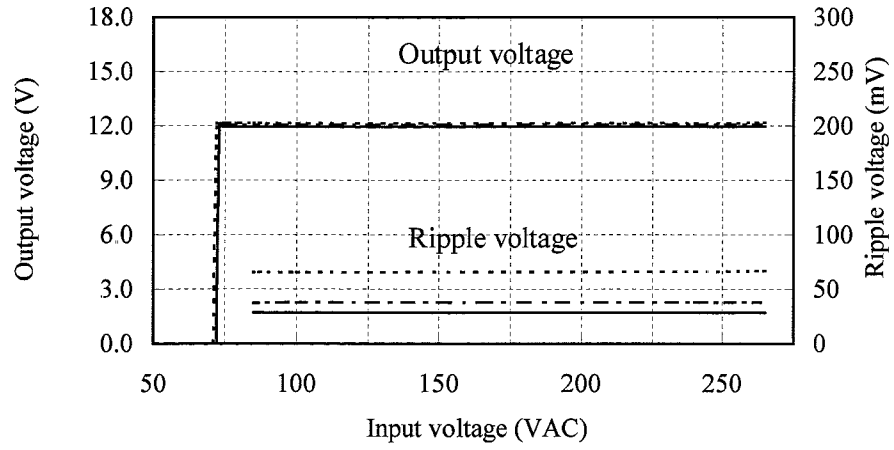

+5VSB

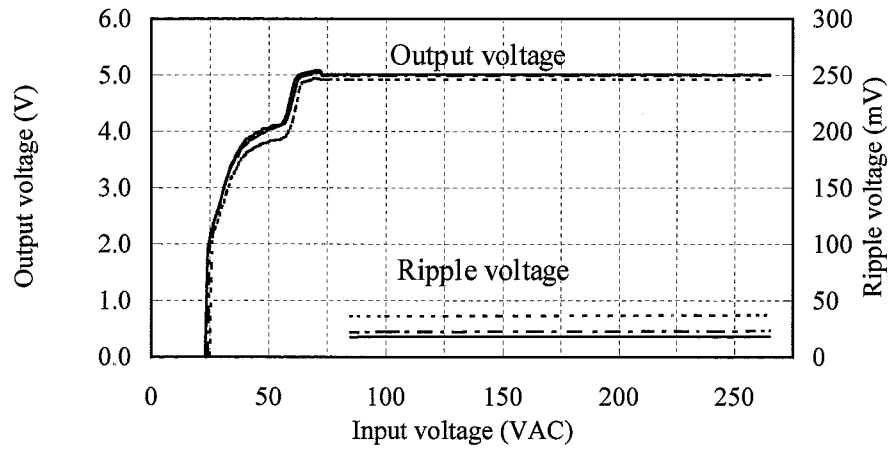

2.1 (2) 出力電圧電圧対入力電圧
Output voltage vs. input voltage

Conditions Iout : FL3
 Ta : 0°C -----
 : 25°C - - - - -
 : 50°C _____

Off line

+3.3V

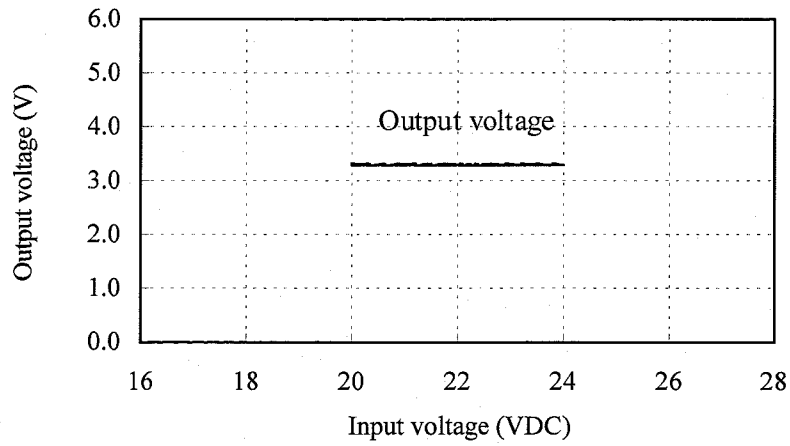

+5V

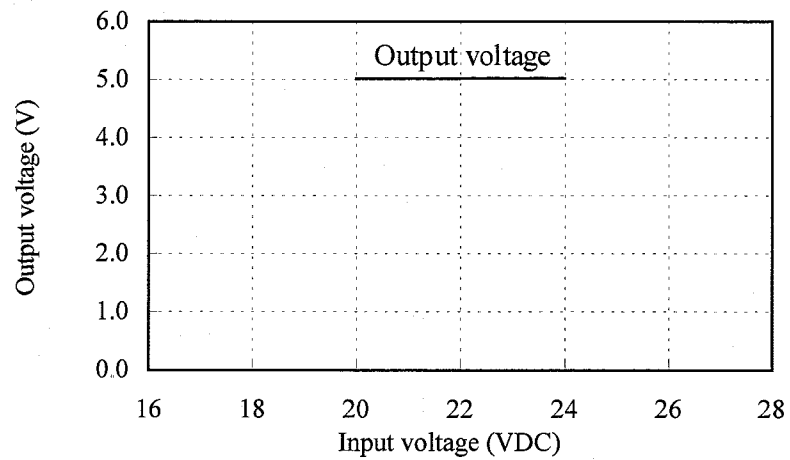

+12V

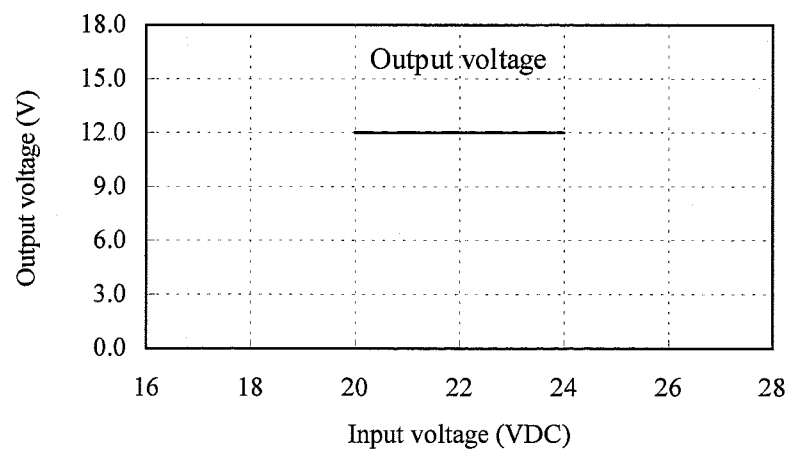

2.1 (2) 出力電圧対入力電圧
Output voltage vs. input voltage

Conditions Iout : FL3
 Ta : 0°C -----
 : 25°C -.-.-.-
 : 50°C _____

Off line

-12V

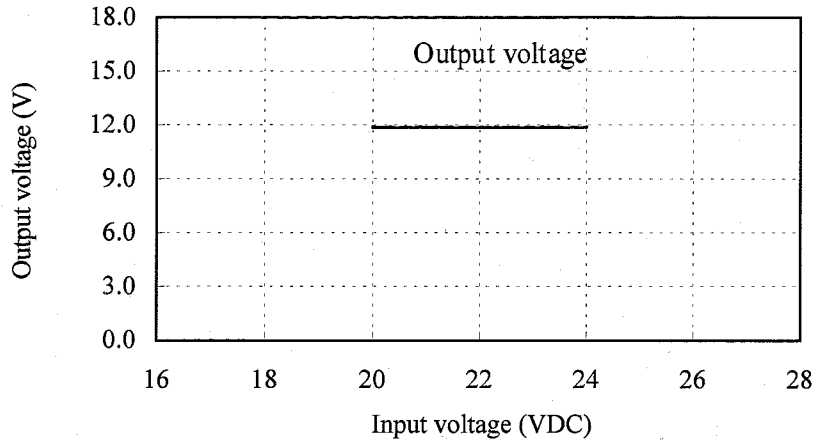

+5VSB

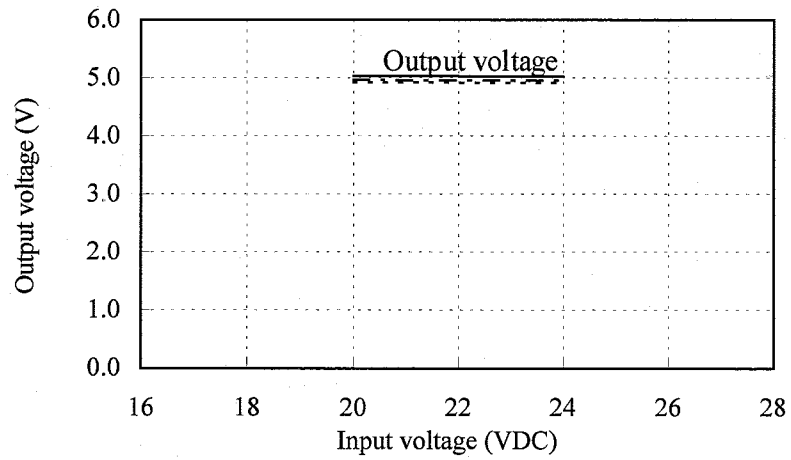

2.1 (2) 出力電圧、リップル電圧対入力電圧
Output voltage and ripple voltage vs. input voltage

Conditions Iout : SB
 Ta : 0°C -----
 : 25°C -----
 : 50°C -----

On line

+5VSB (Standby)

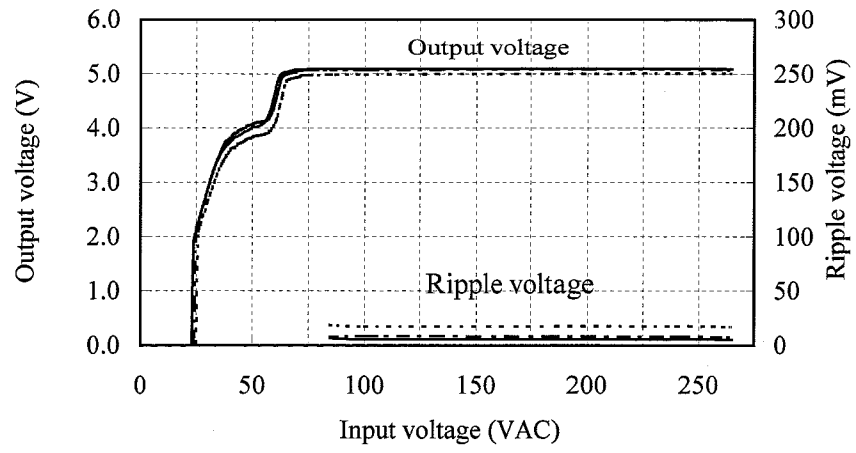

2.1 (3) 効率、入力電流対出力電流
Efficiency and input current vs. output current

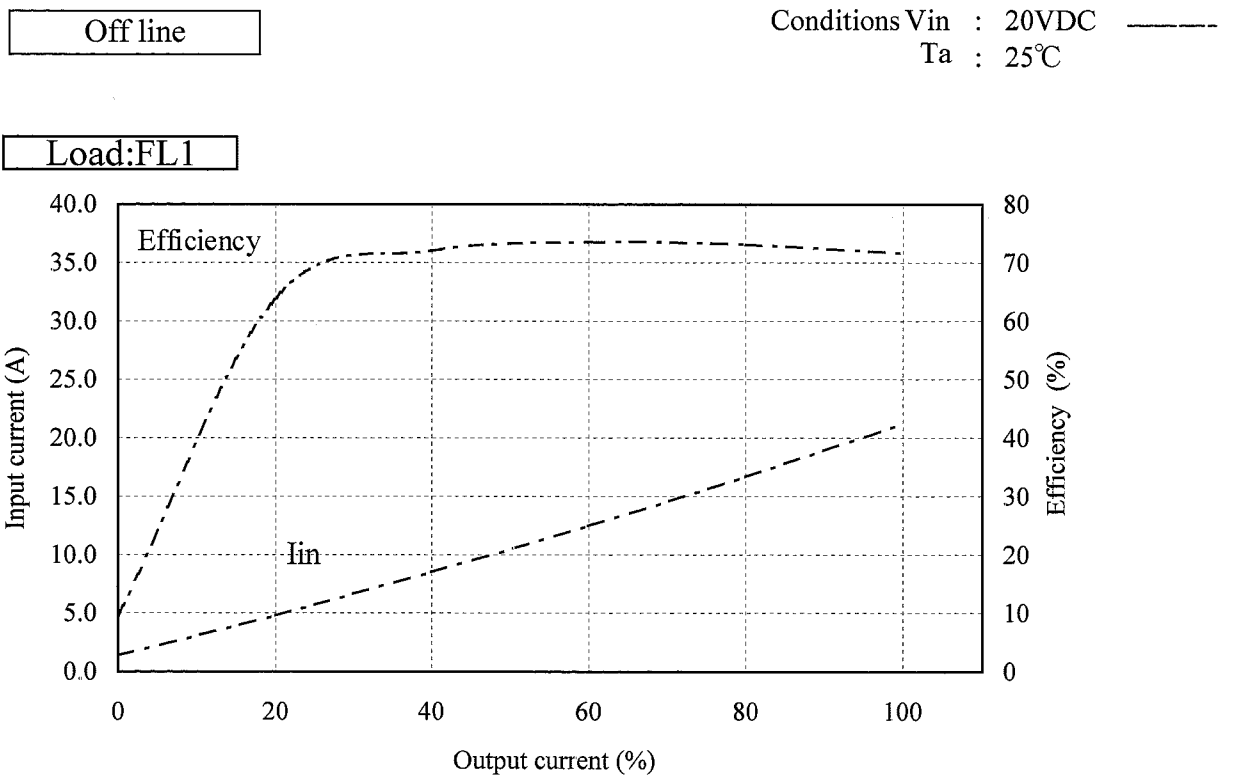
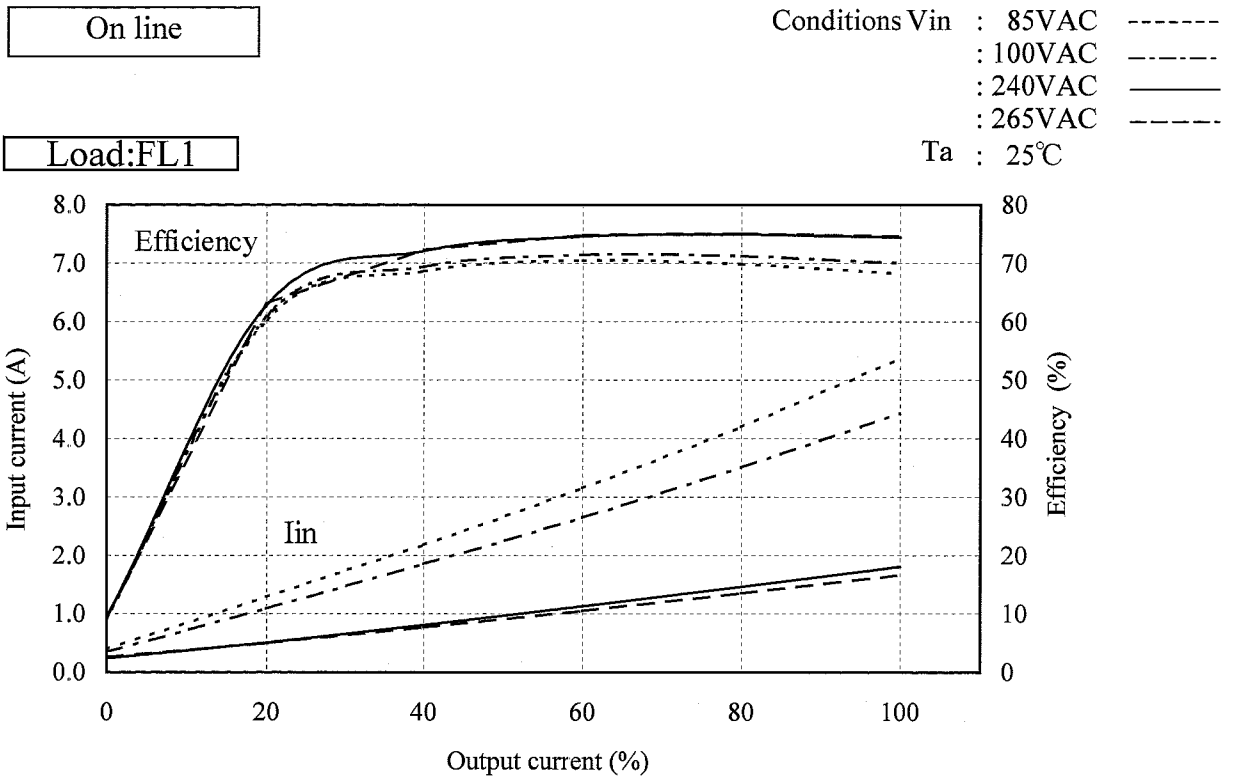

2.1 (3) 効率、入力電流対出力電流
Efficiency and input current vs. output current

On line

Conditions V_{in} : 85VAC -----
: 100VAC - - - - -
: 240VAC _____
: 265VAC - - - - -

Load:FL2

T_a : 25°C

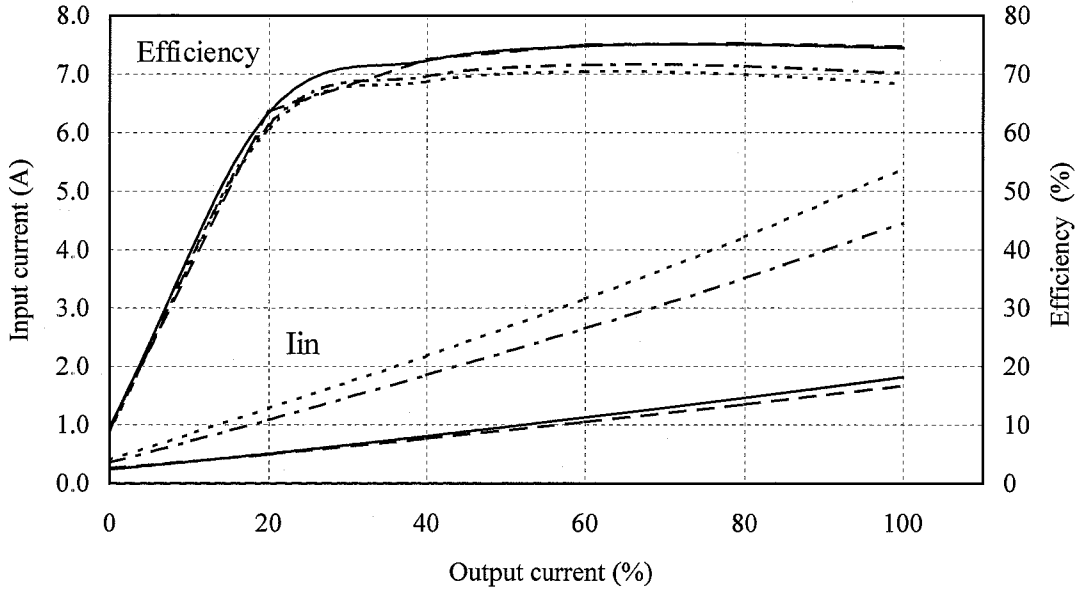

Off line

Conditions V_{in} : 20VDC -----
 T_a : 25°C

Load:FL2

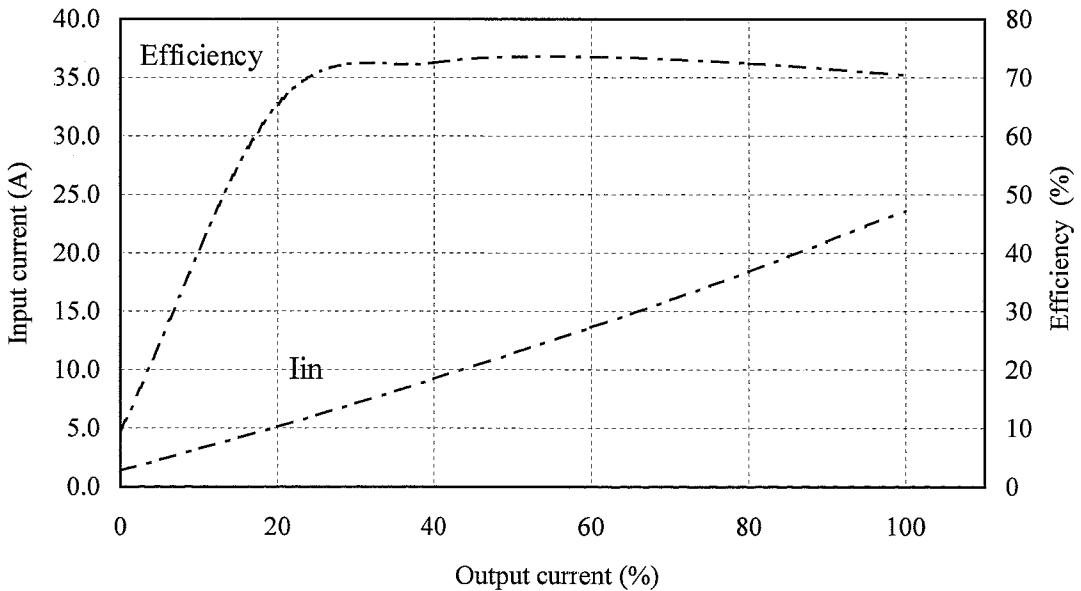

2.1 (3) 効率、入力電流対出力電流
Efficiency and input current vs. output current

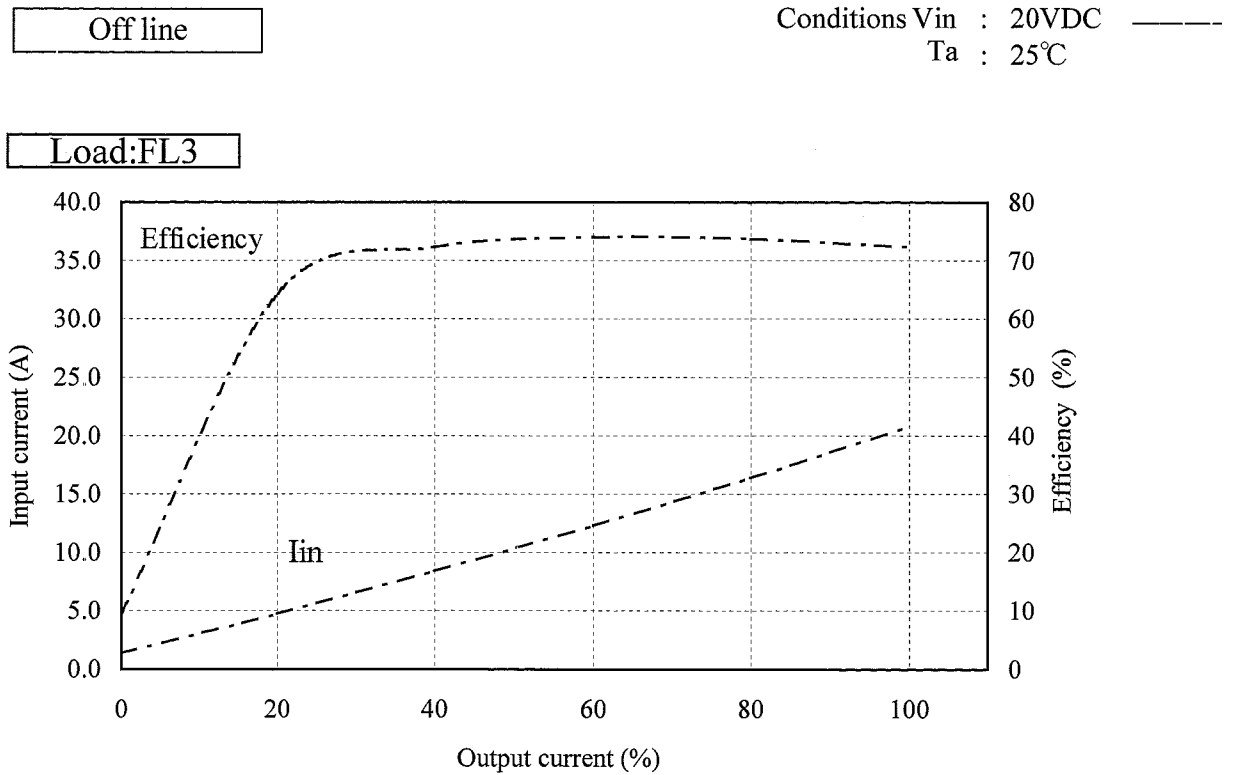
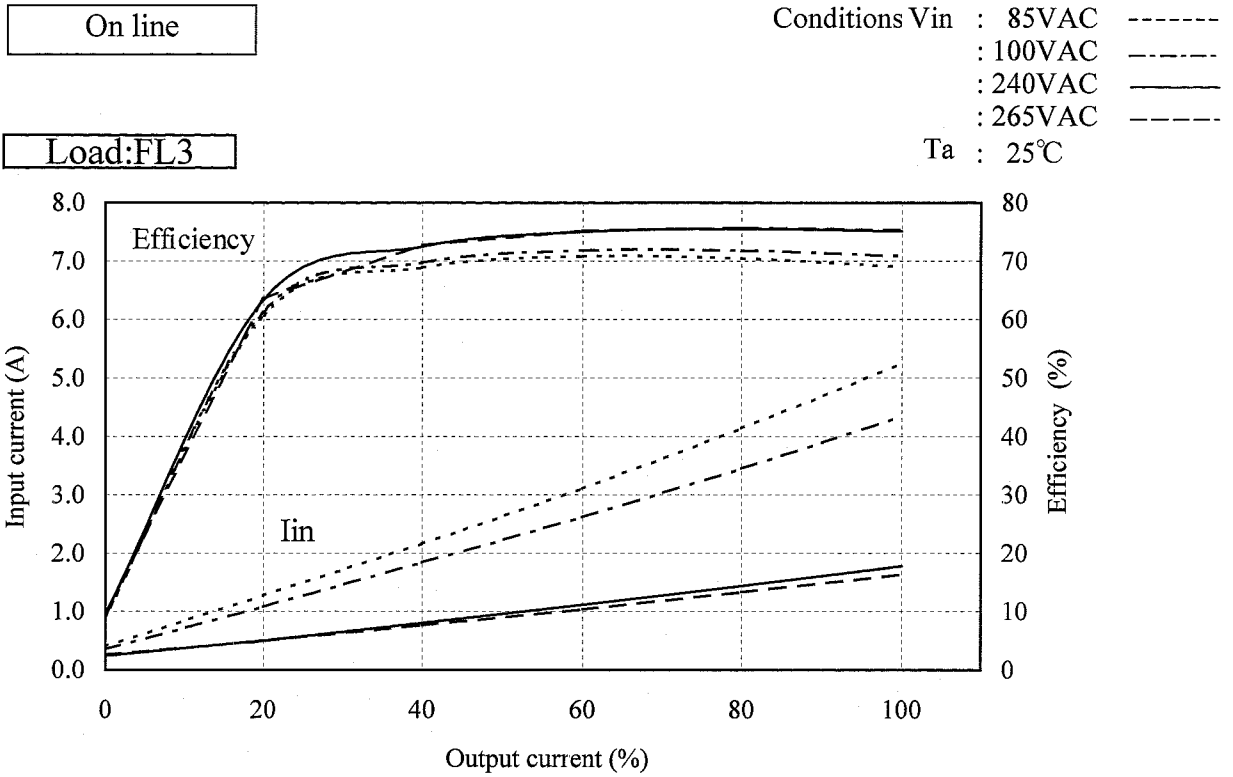

UNA350P*

2.1 (3) 効率、入力電流対出力電流
Efficiency and input current vs. output current

Conditions V_{in} : 85VAC -----
 : 100VAC -----
 : 240VAC -----
 : 265VAC -----
 T_a : 25°C

On line

Standby

Load:SB

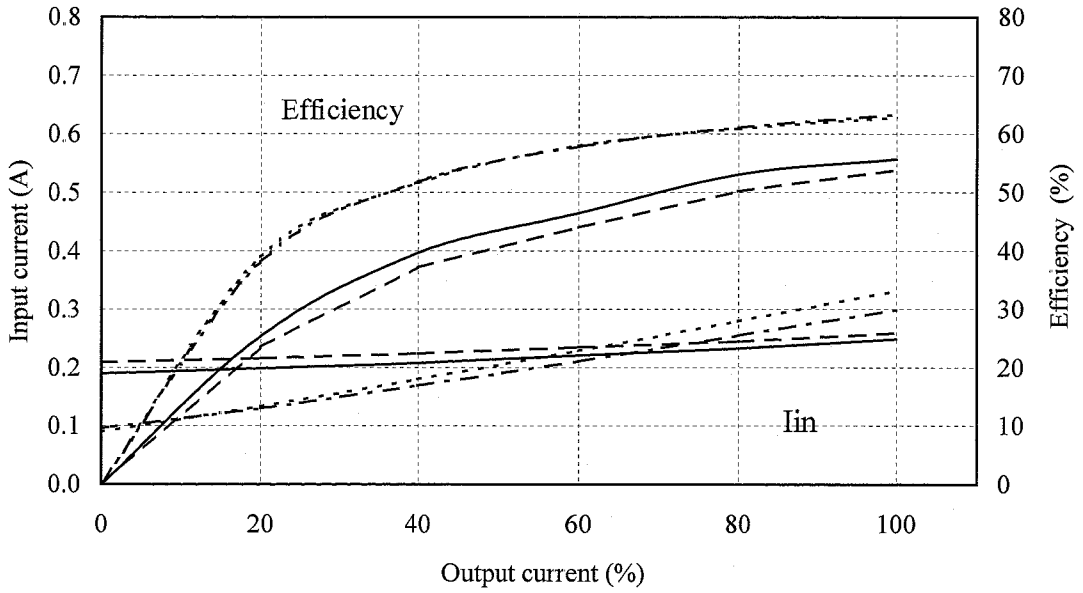

2.1 (4) 力率、入力電流対出力電流
Power factor and input current vs. output current

On line

Conditions Vin : 85VAC -----
: 100VAC - - - - -
: 240VAC _____
: 265VAC - - - - -

Load:FL1

Ta : 25°C

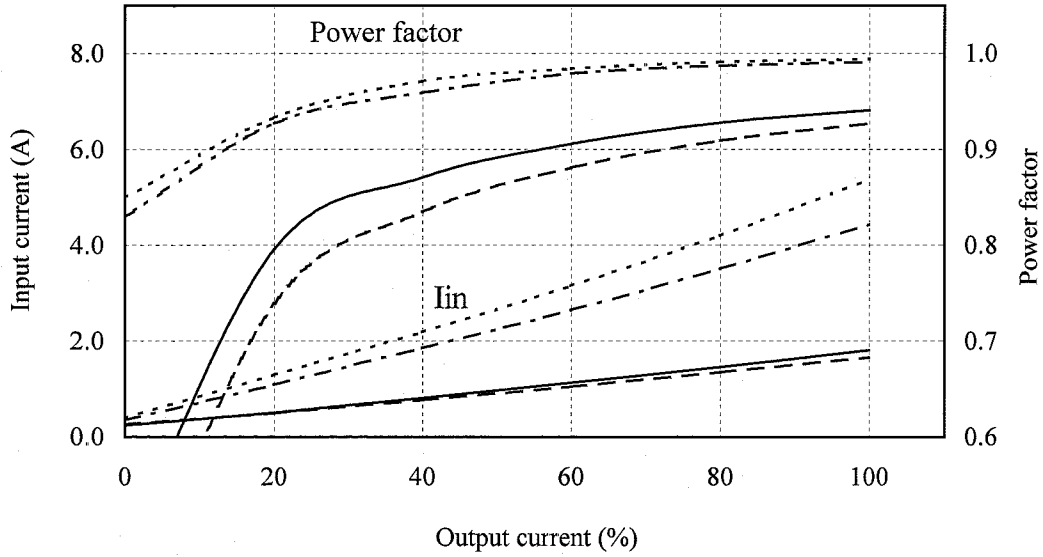

On line

Conditions Vin : 85VAC -----
: 100VAC - - - - -
: 240VAC _____
: 265VAC - - - - -

Load:FL2

Ta : 25°C

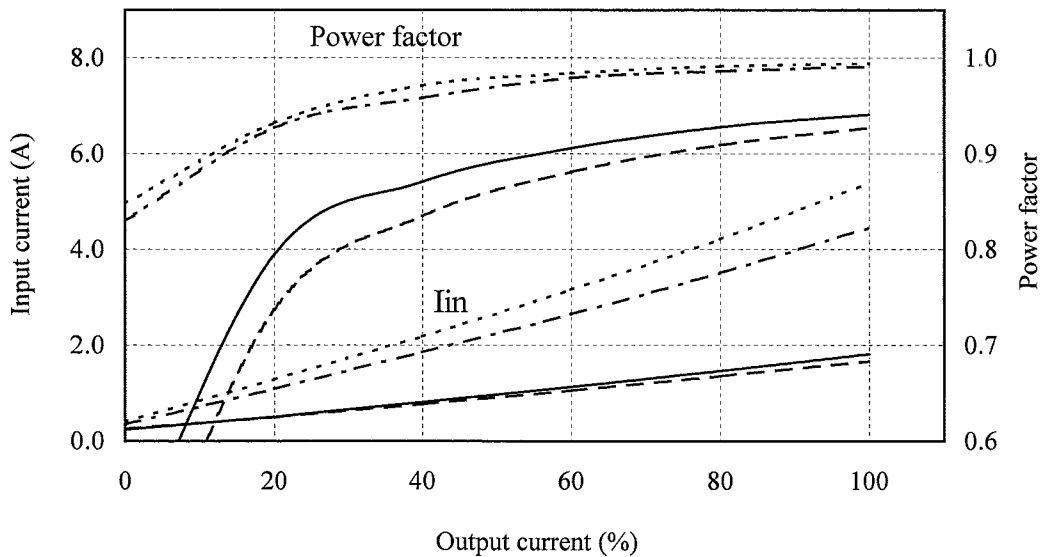

2.1 (4) 力率、入力電流対出力電流
Power factor and input current vs. output current

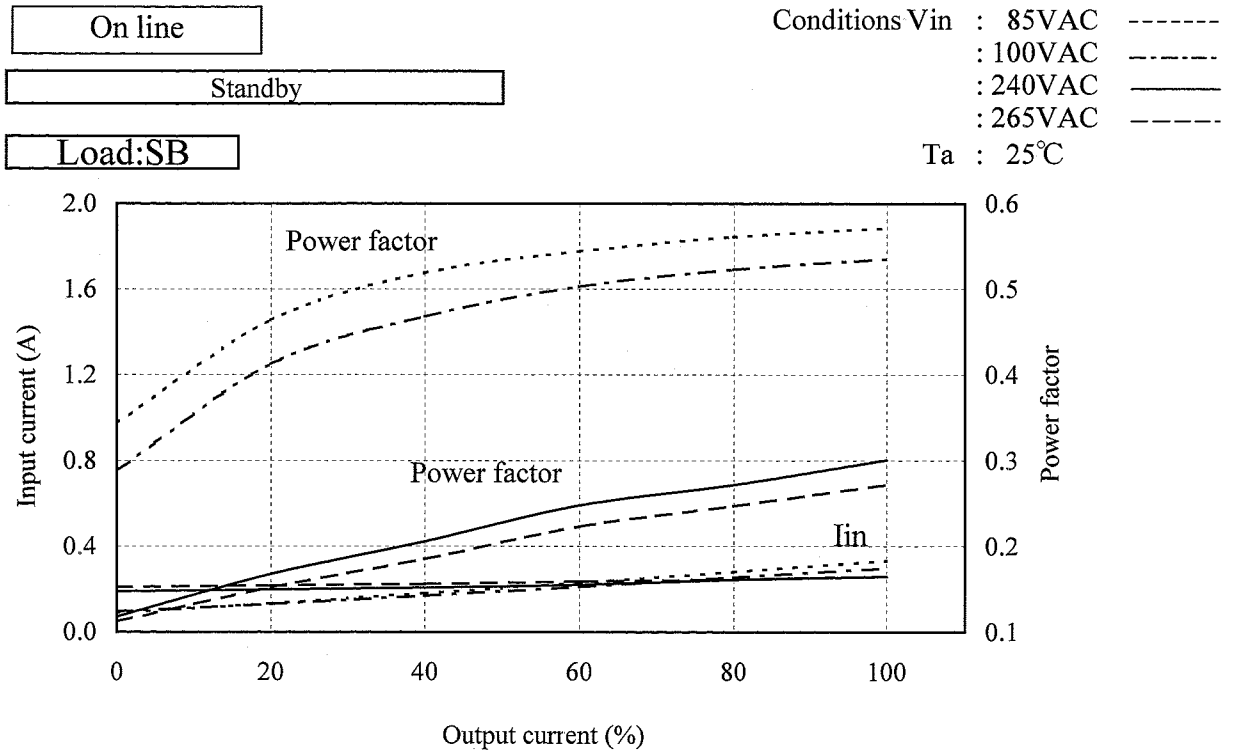
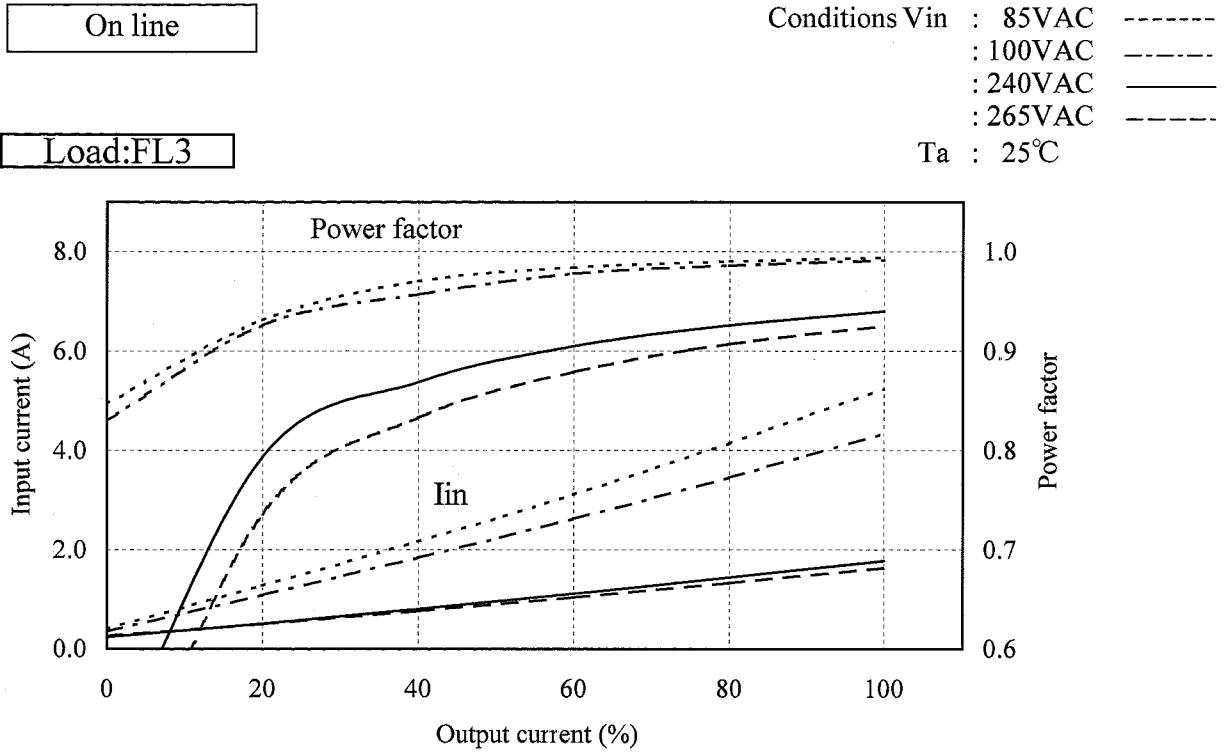

2.2 通電ドリフト特性

Warm up voltage drift characteristics

Conditions V_{in} : 100VAC

I_o : 100%(FL1)

T_a : 25°C

+3.3V

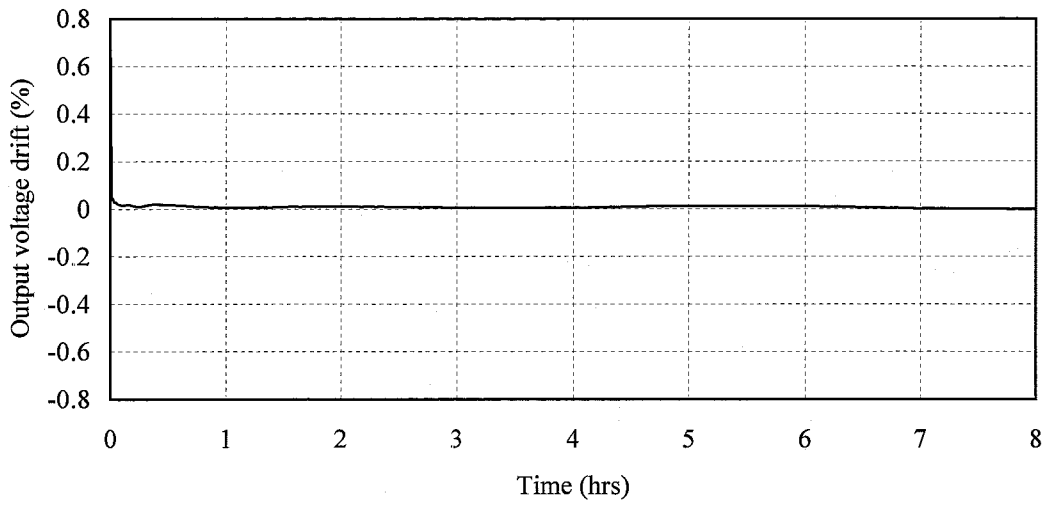

+5V

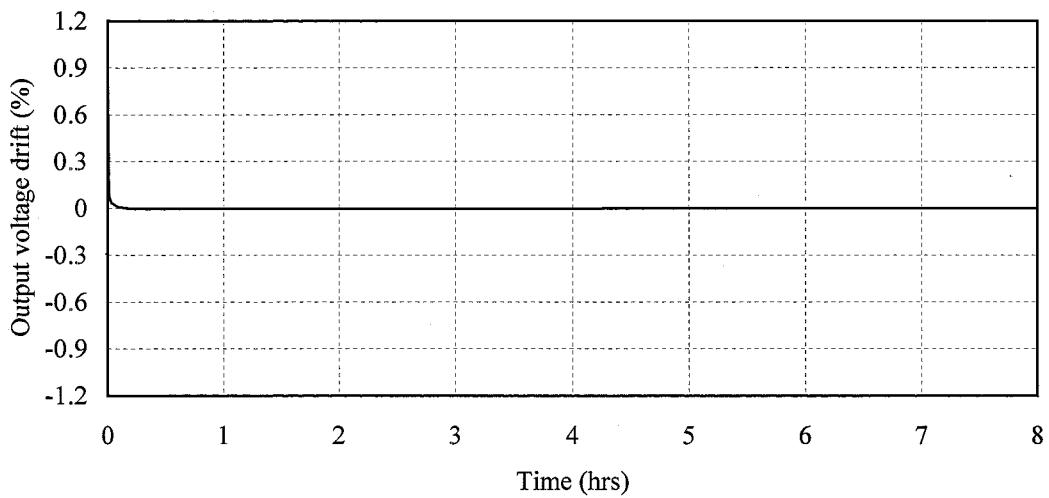

+12V

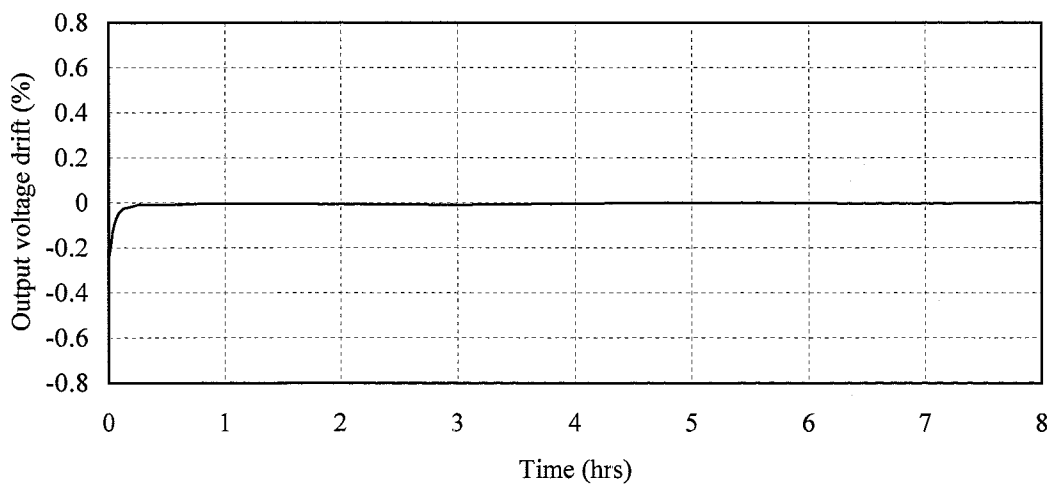

2.2 通電ドリフト特性
Warm up voltage drift characteristics

Conditions V_{in} : 100VAC
 I_o : 100%(FL1)
 T_a : 25°C

-12V

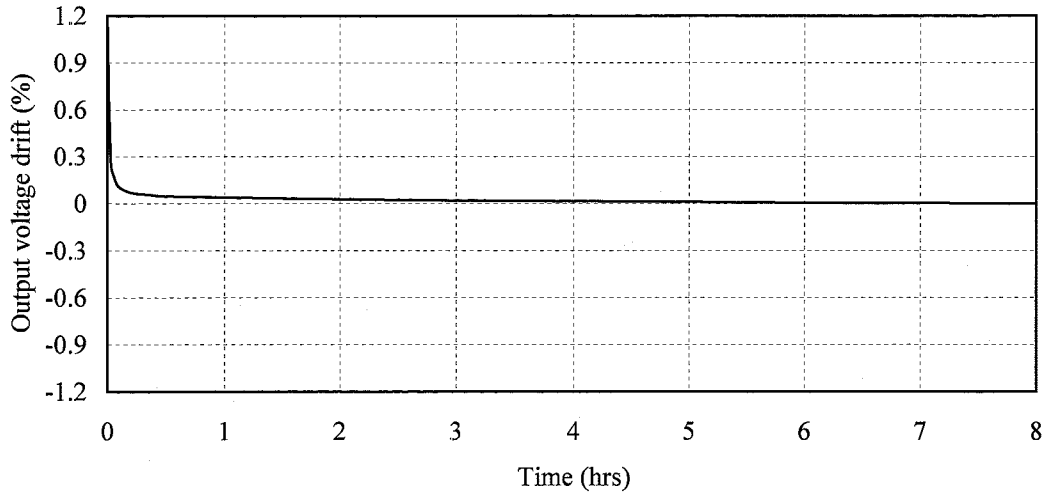

+5VSB

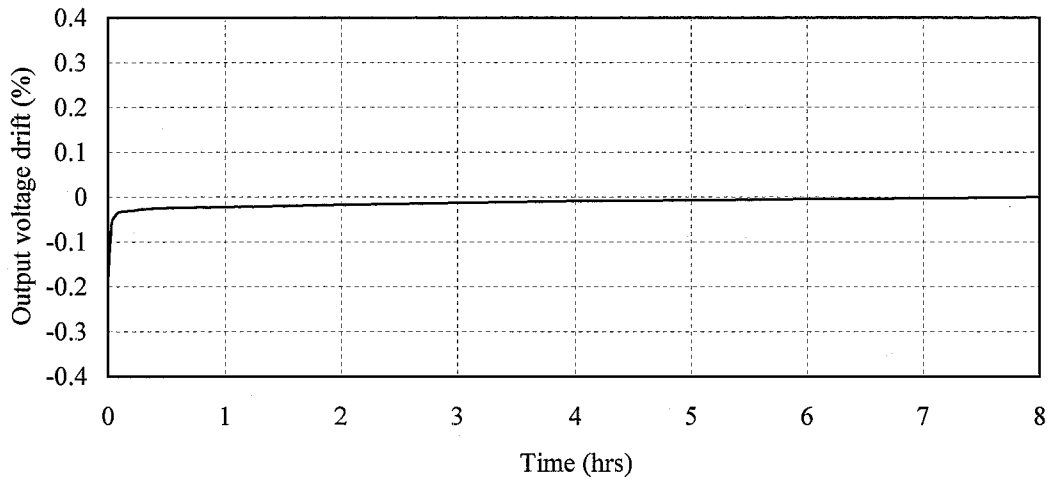

2.2 通電ドリフト特性
Warm up voltage drift characteristics

Conditions V_{in} : 100VAC
 I_o : 100%(FL2)
 T_a : 25°C

+3.3V

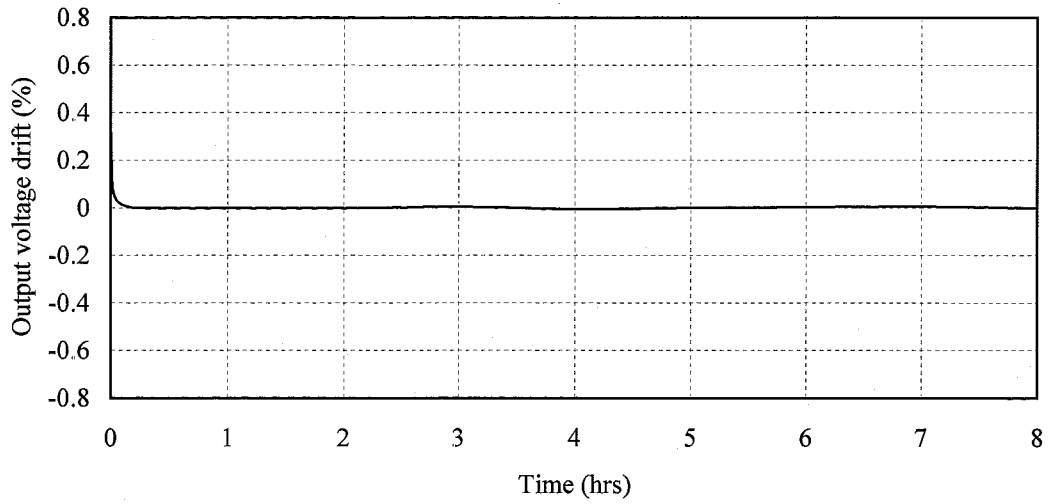

+5V

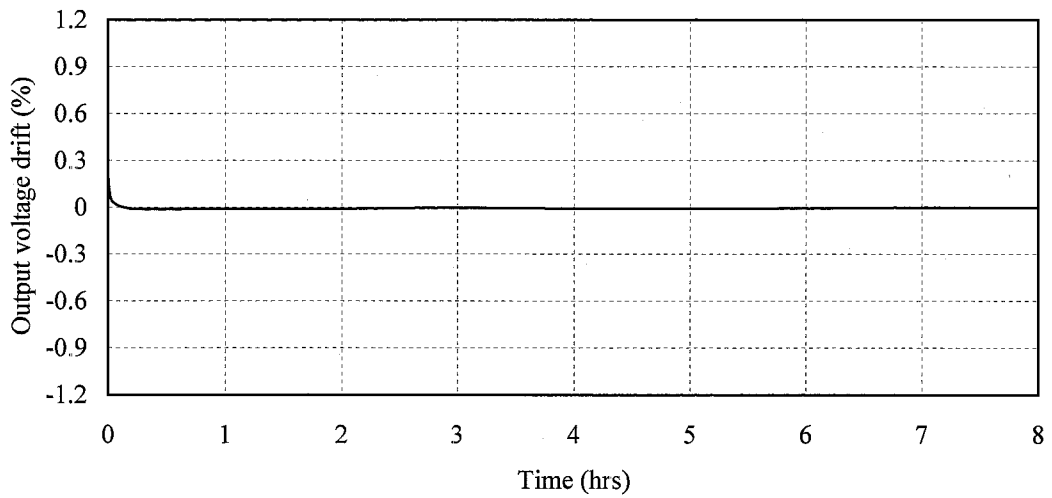

+12V

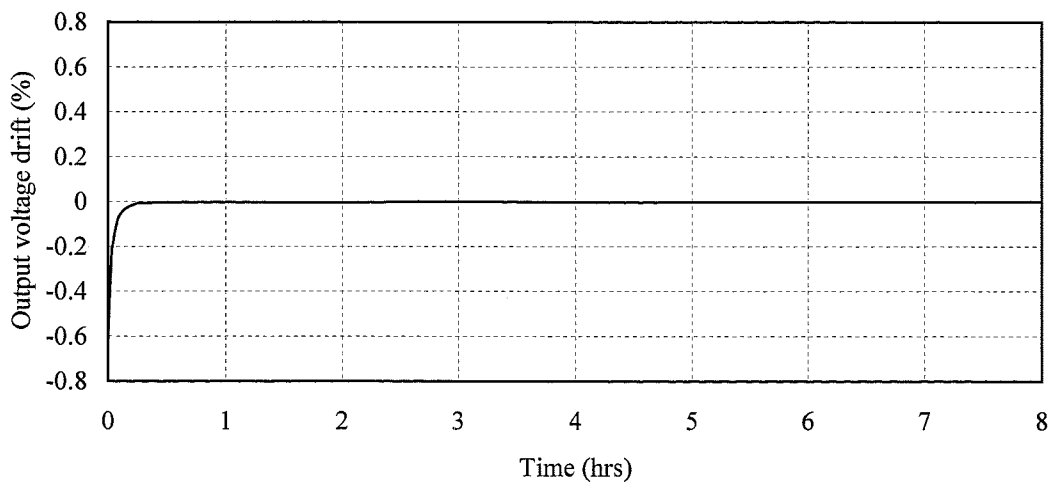

2.2 通電ドリフト特性

Warm up voltage drift characteristics

Conditions V_{in} : 100VAC

I_o : 100%(FL2)

T_a : 25°C

-12V

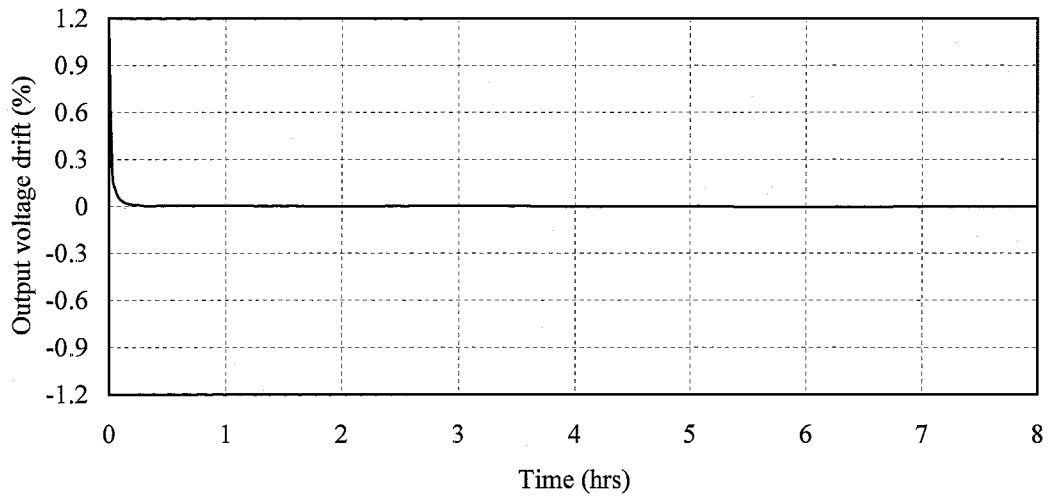

+5VSB

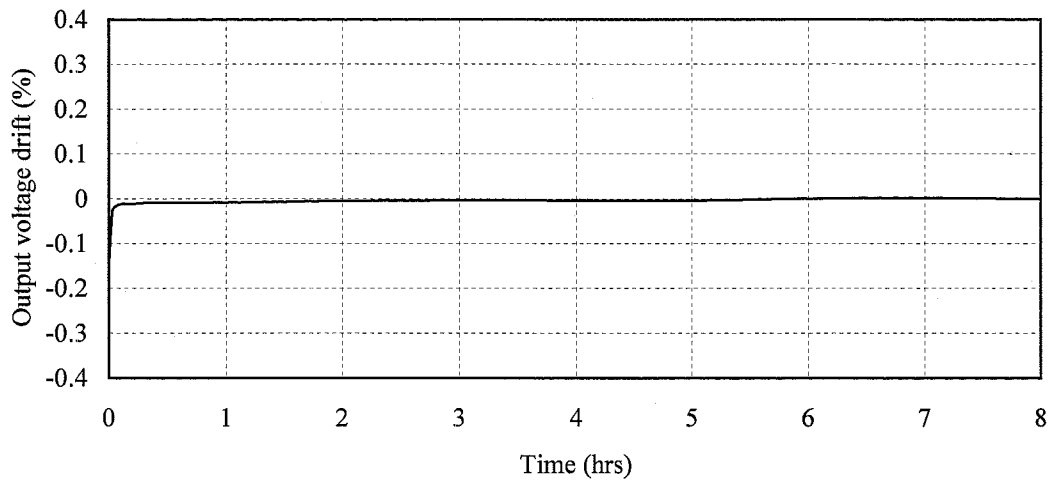

2.2 通電ドリフト特性
Warm up voltage drift characteristics

Conditions V_{in} : 100VAC
 I_o : 100%(FL3)
 T_a : 25°C

+3.3V

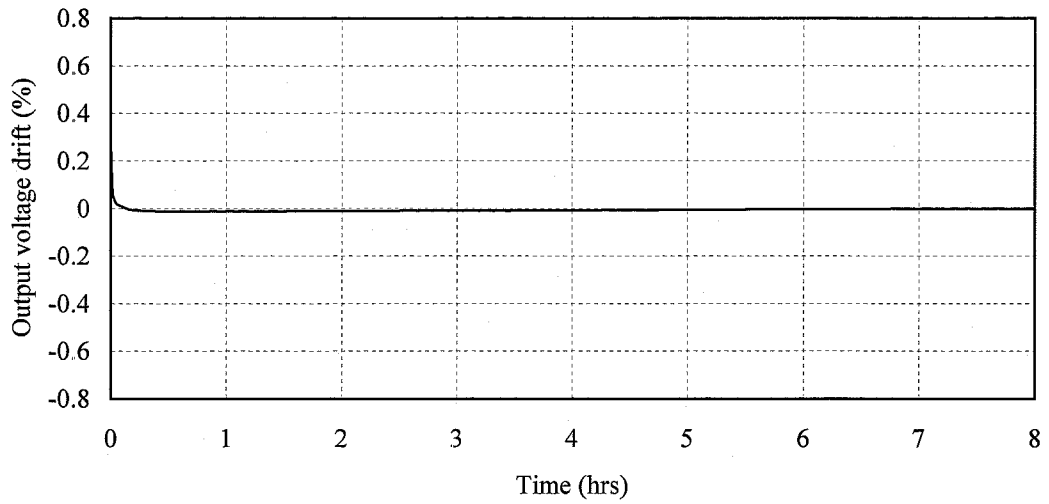

+5V

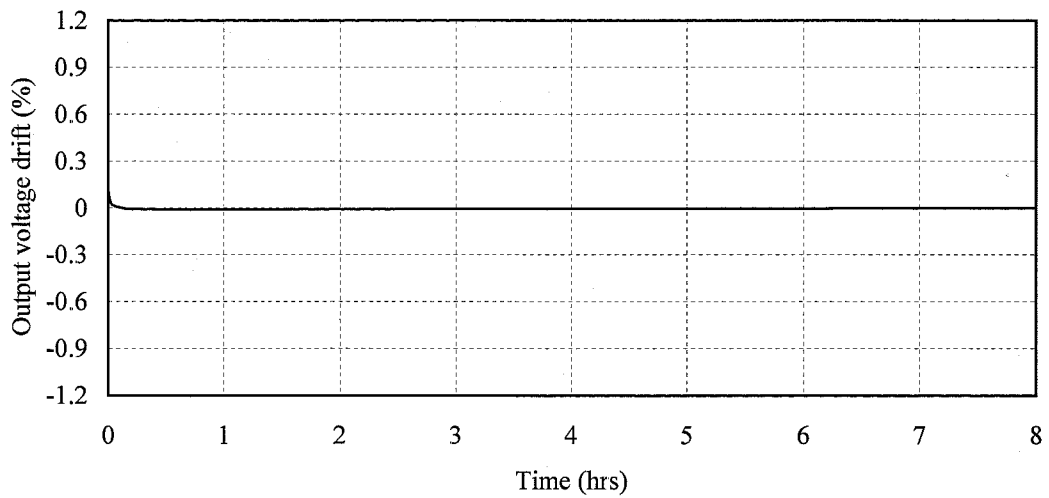

+12V

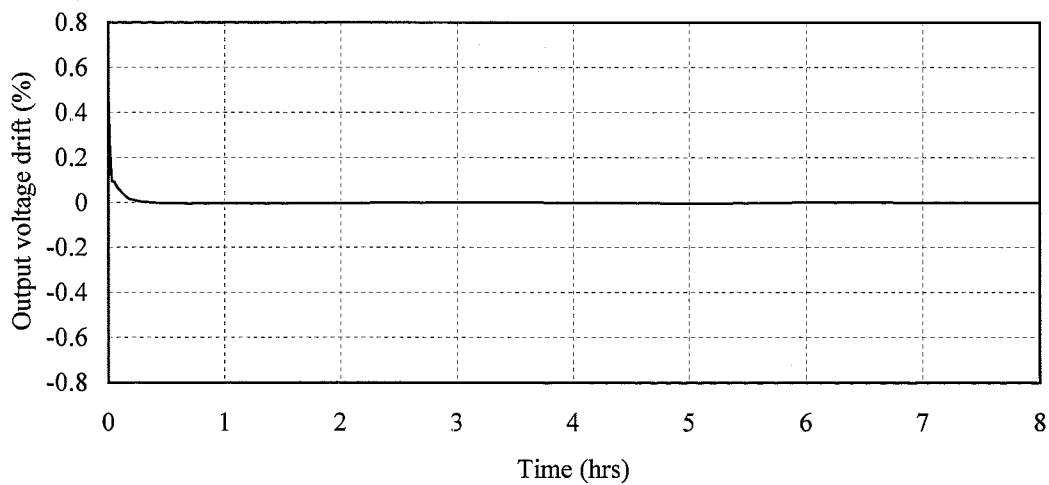

2.2 通電ドリフト特性
Warm up voltage drift characteristics

Conditions V_{in} : 100VAC
 I_o : 100%(FL3)
 T_a : 25°C

-12V

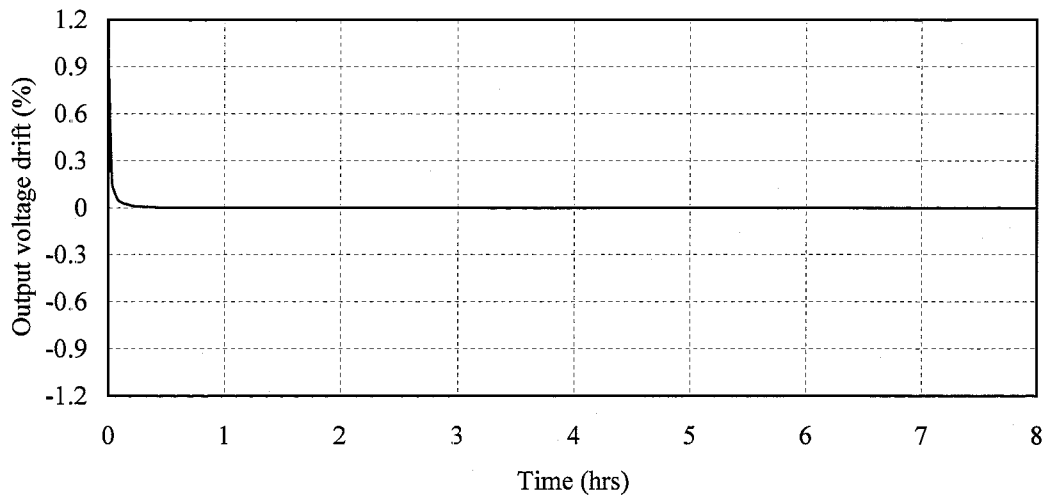

+5VSB

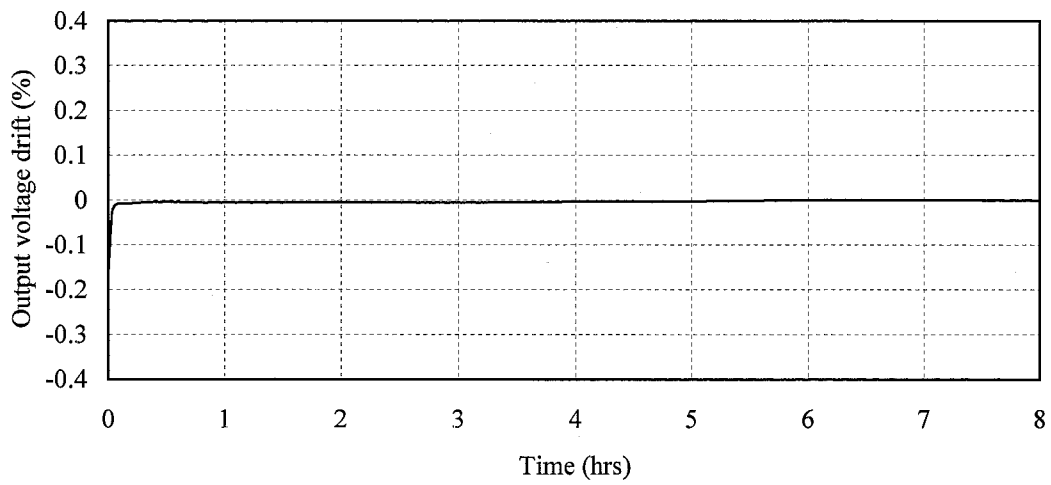

2.3 過電流保護特性

Over current protection (OCP) characteristics

Conditions Ta : 0°C -----
 : 25°C - - - - -
 : 50°C _____
 Vin : 100 / 240VAC

+3.3V

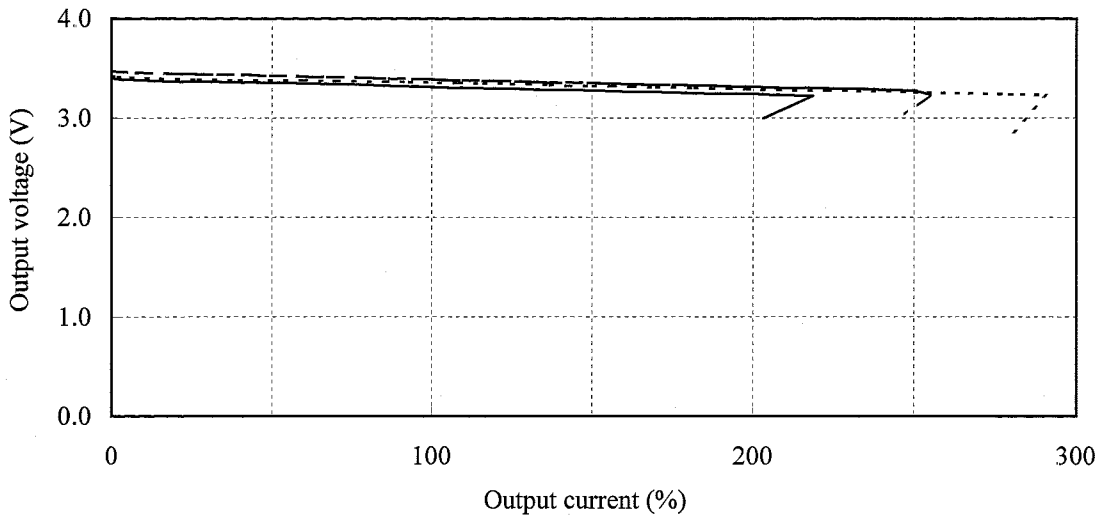

+5V

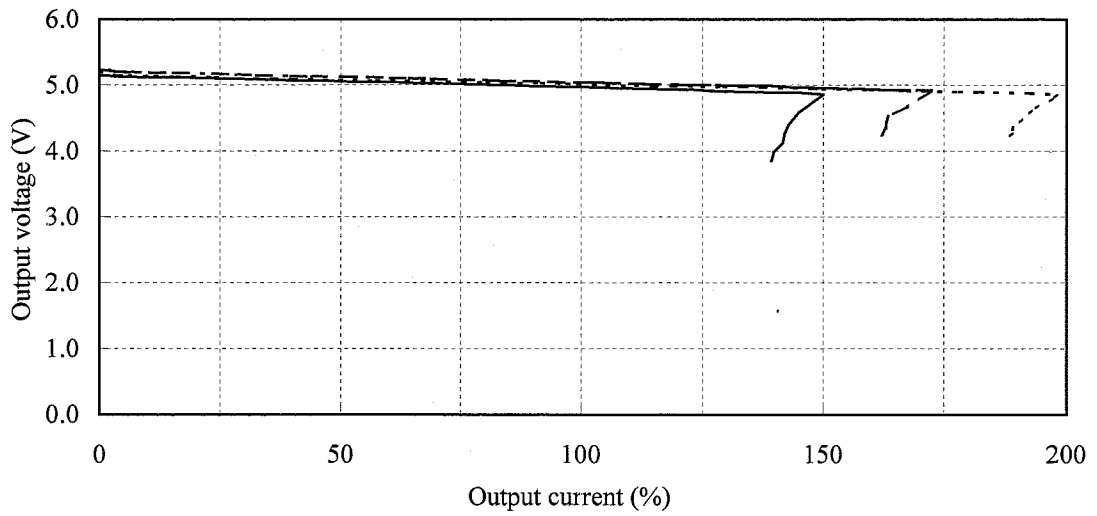

+12V

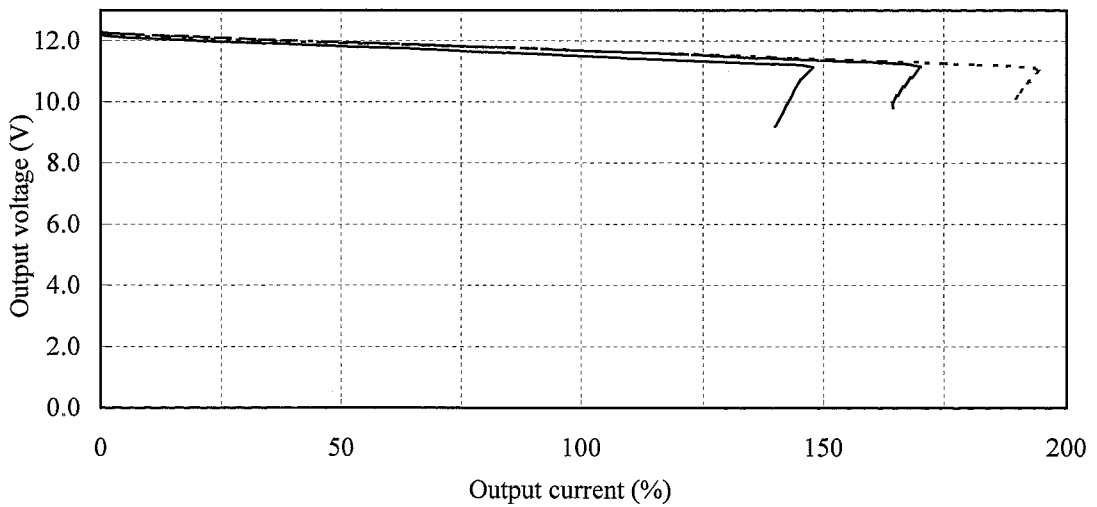

2.3 過電流保護特性

Over current protection (OCP) characteristics

Conditions Ta : 0°C -----
 : 25°C - - - - -
 : 50°C _____
 Vin : 100 / 240VAC

-12V

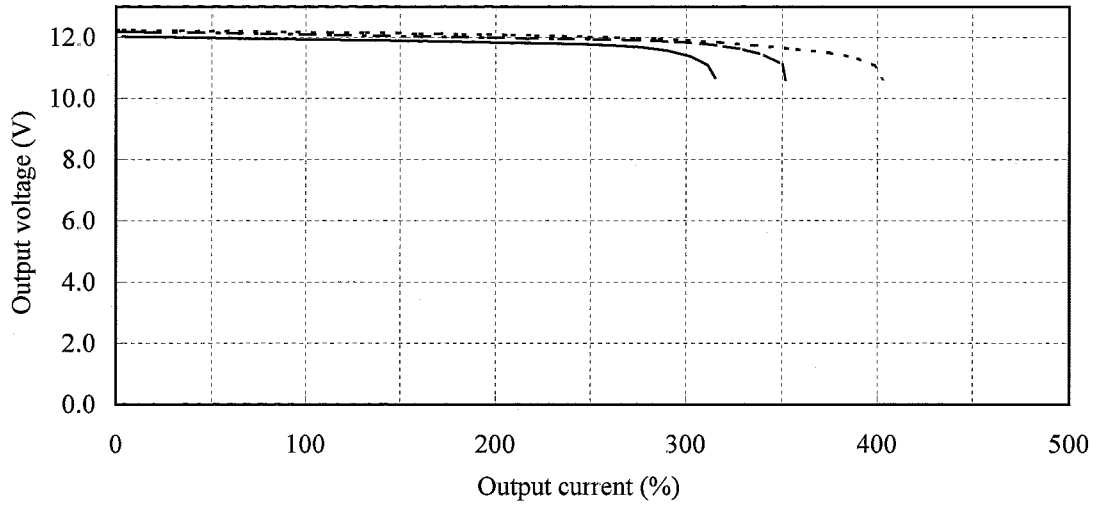

+5VSB

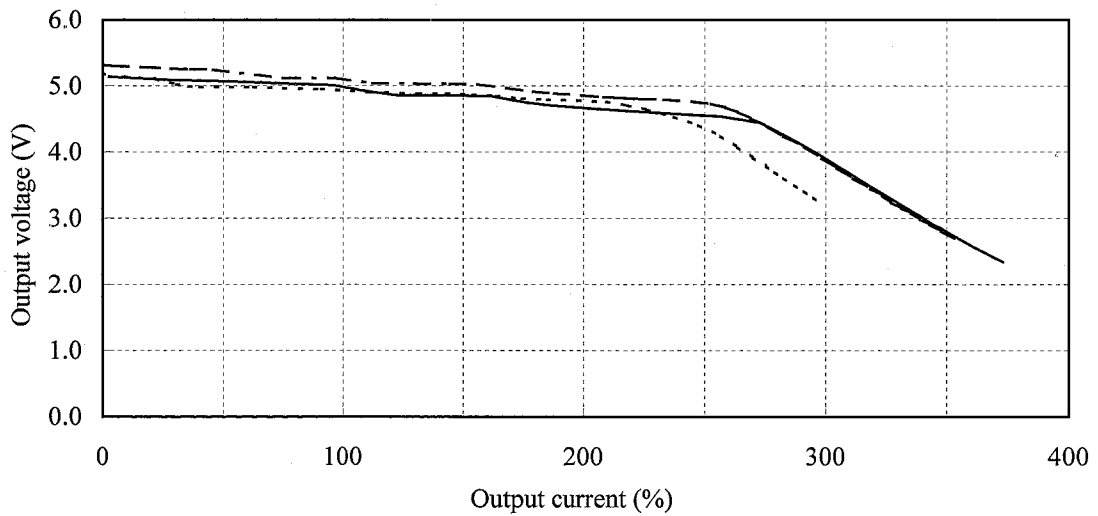

Charger

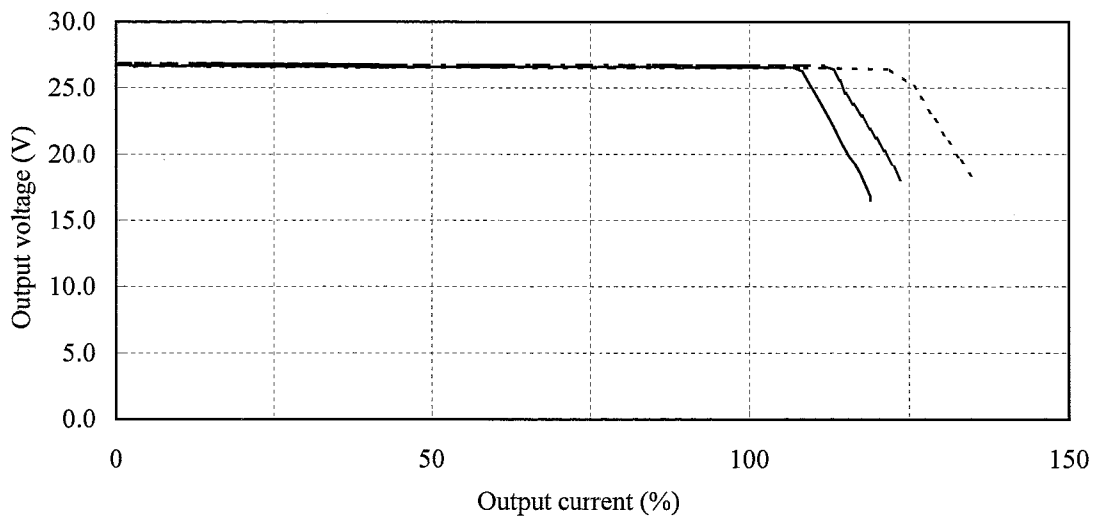

2.3 過電流保護特性

Over current protection (OCP) characteristics

Conditions Vin : 85VAC -----
 : 100VAC -----
 : 240VAC -----
 : 265VAC -----

+5VSB (Standby)

Ta: 0°C

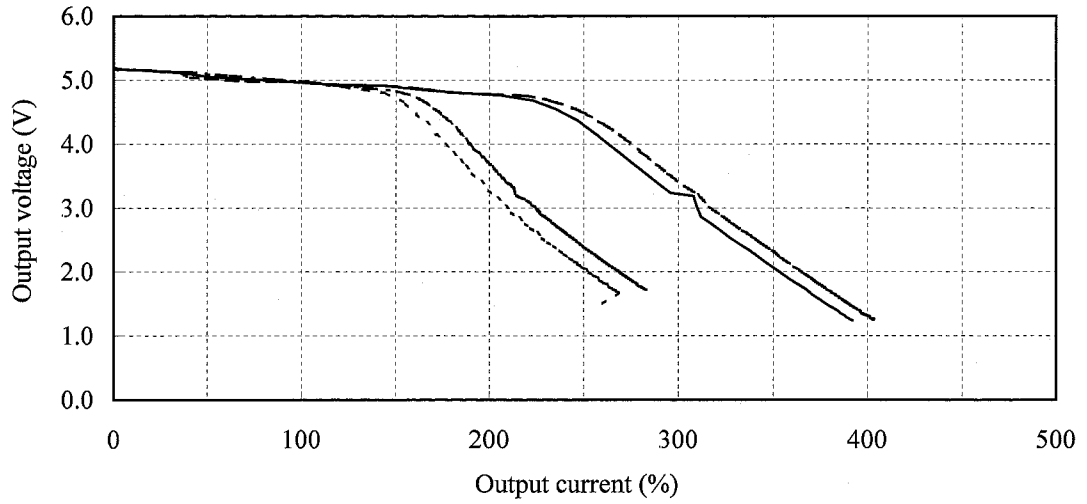

Ta: 25°C

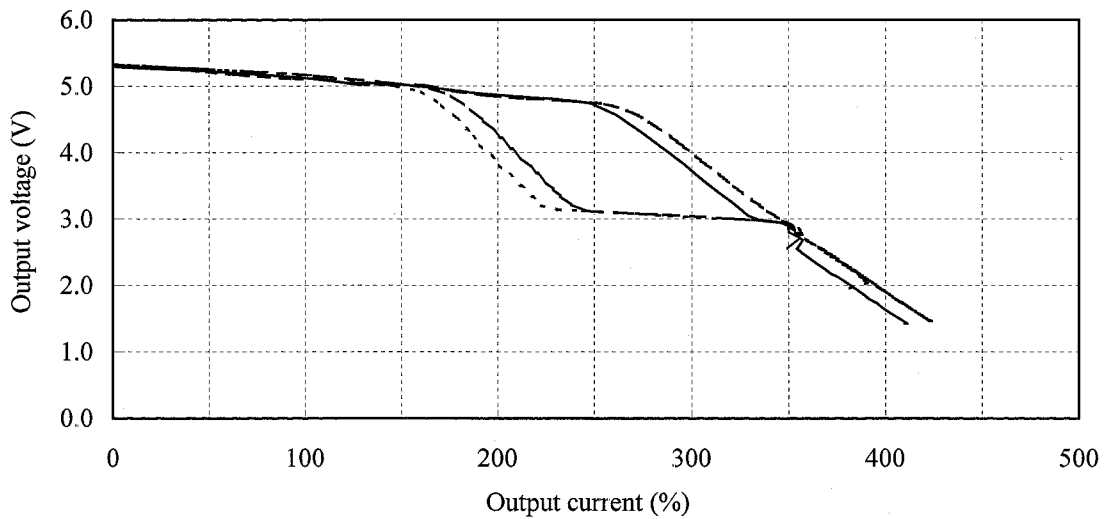

Ta: 50°C

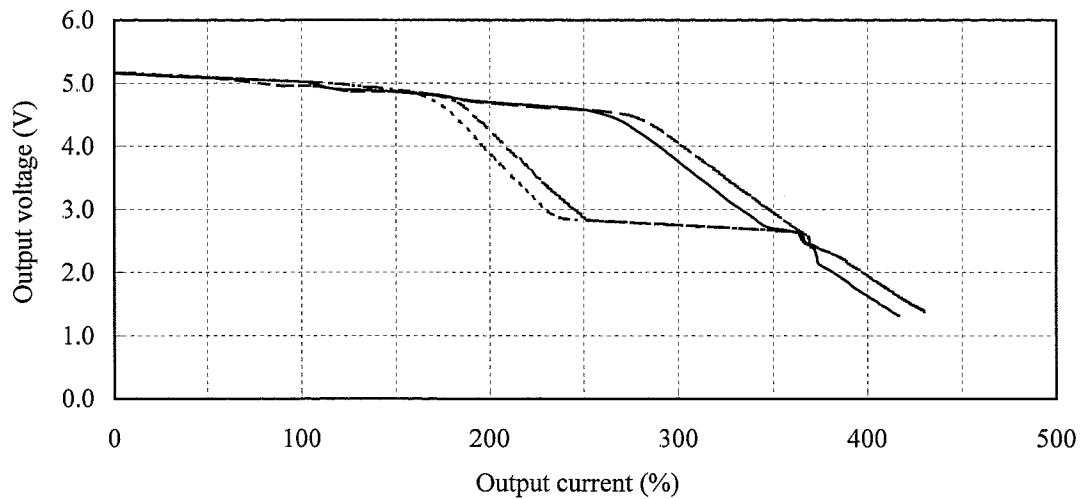

2.4 過電圧保護特性
Over voltage protection (OVP) characteristics

Conditions V_{in} : 100VAC
 I_o : Min

Vo\Temp	Ta0°C	Ta25°C	Ta50°C
+3.3V	4.04 V	4.05 V	3.93 V
+5V	6.35 V	6.19 V	6.08 V
+12V	14.38 V	14.68 V	14.97 V

Conditions Vin : 100VAC
 Ta : 25°C

2.5 出力立ち上がり特性
 Output rise characteristics

+5VSB

Iout : 0%

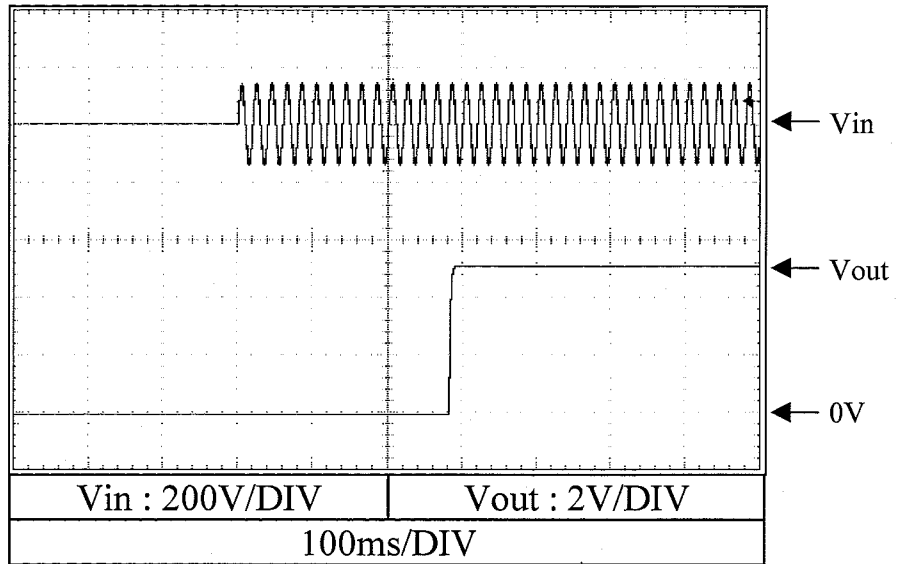

Iout : 100%

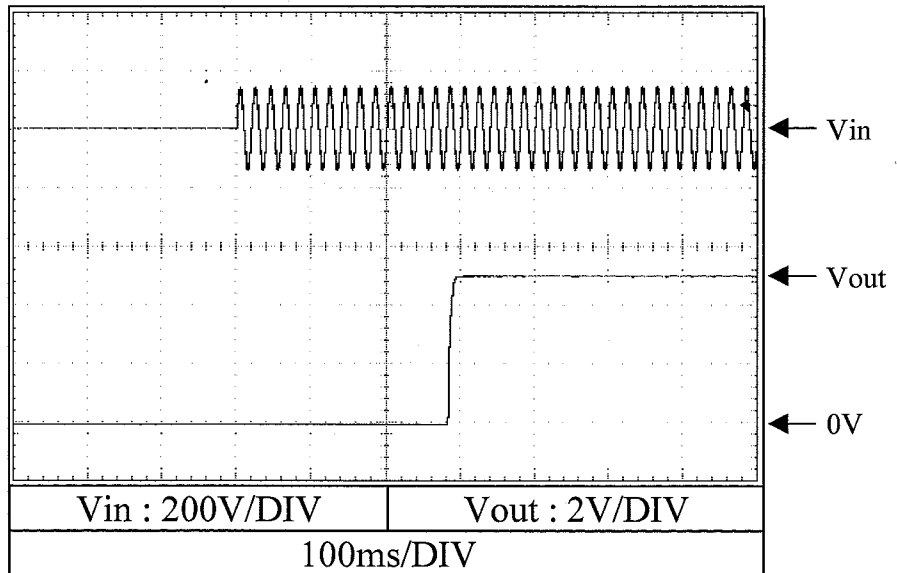

Conditions Vin : 100VAC
 Ta : 25°C

2.6 出力立ち下がり特性
 Output fall characteristics

+5VSB

Iout : 0%

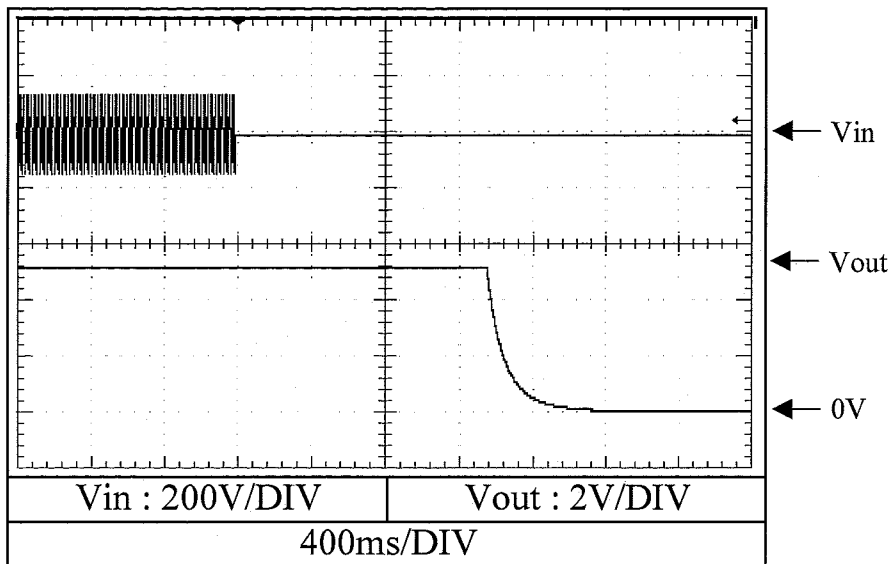

Iout : 100%

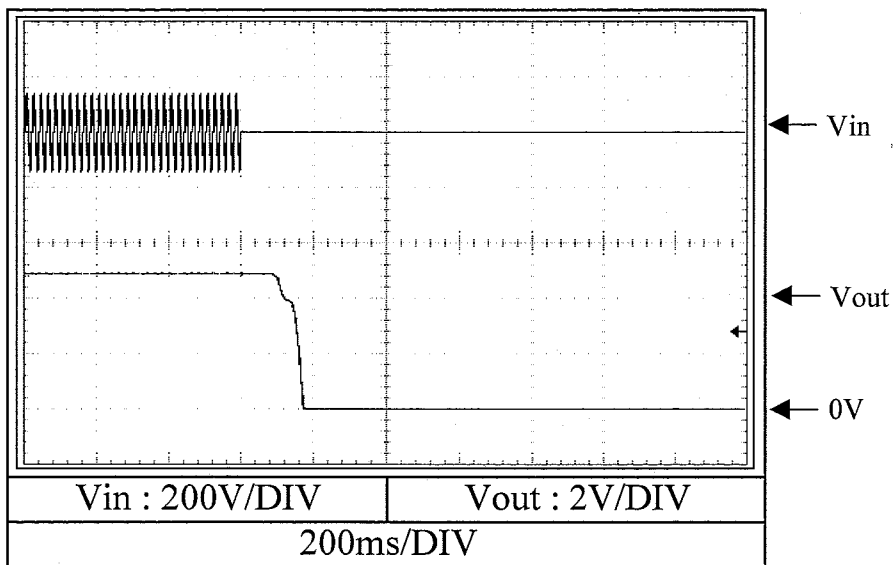

Conditions Vin : 100VAC
 Iout : 100%(FL1)
 Ta : 25°C

2.7 ON/OFFコントロール時出力立ち上がり特性
 Output rise characteristics with ON/OFF CONTROL

+3.3V

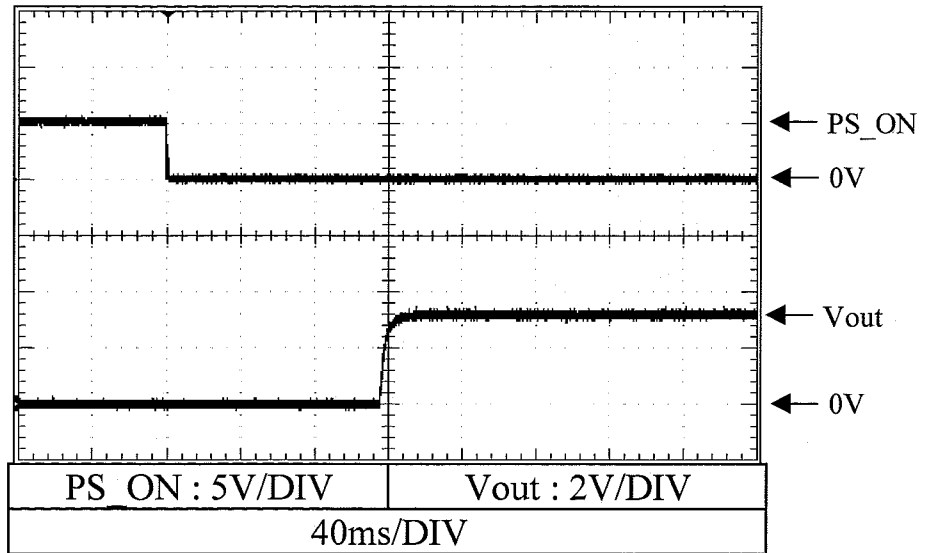

+5V

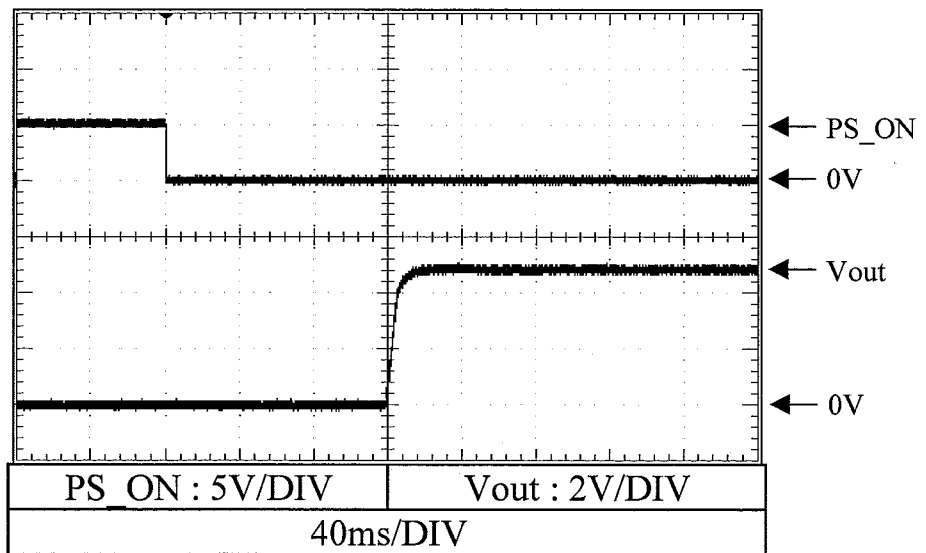

+12V

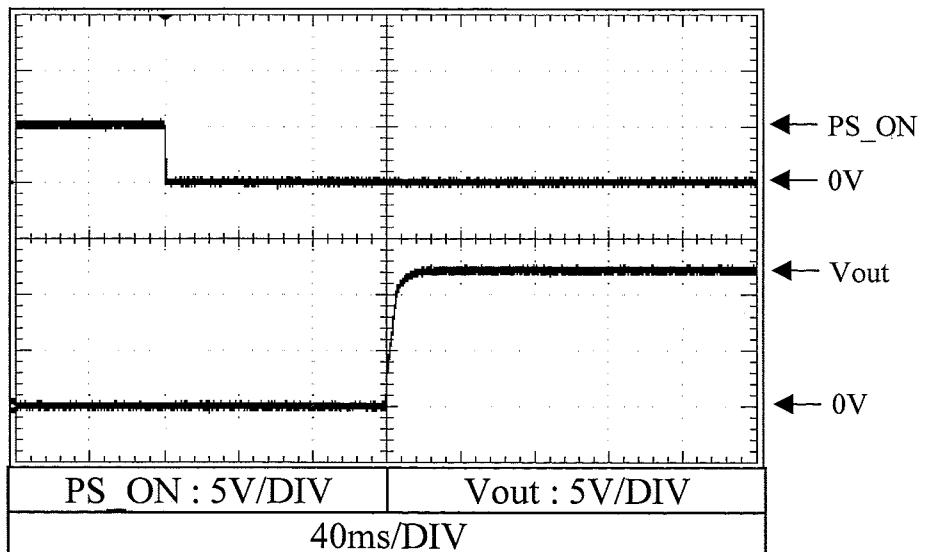

Conditions Vin : 100VAC
Iout : 100%(FL1)
Ta : 25°C

2.7 ON/OFFコントロール時出力立ち上がり特性
Output rise characteristics with ON/OFF CONTROL

-12V

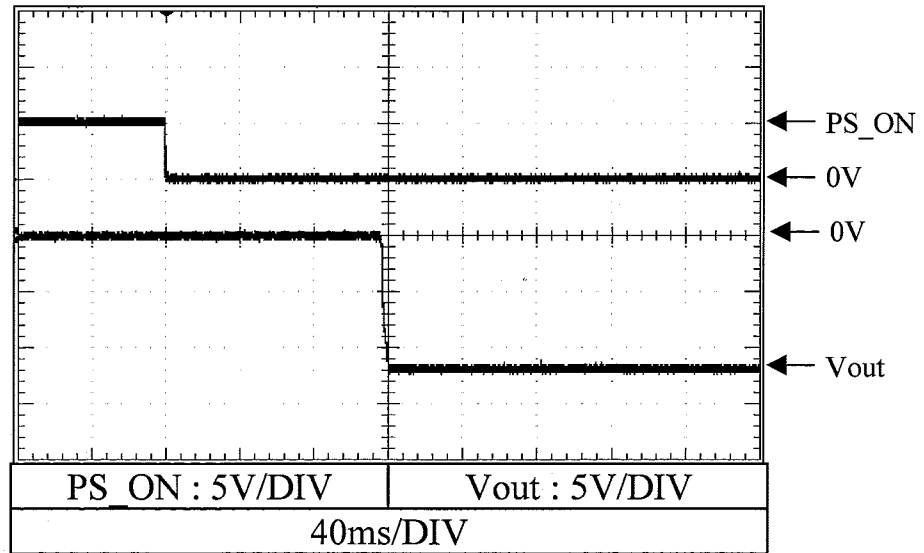

Conditions Vin : 100VAC
 Iout : 100%(FL2)
 Ta : 25°C

2.7 ON/OFFコントロール時出力立ち上がり特性
 Output rise characteristics with ON/OFF CONTROL

+3.3V

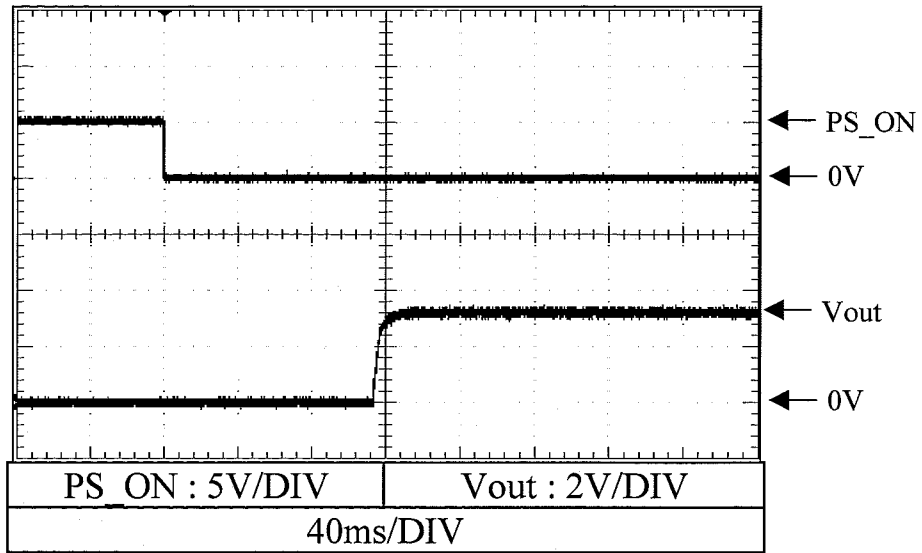

+5V

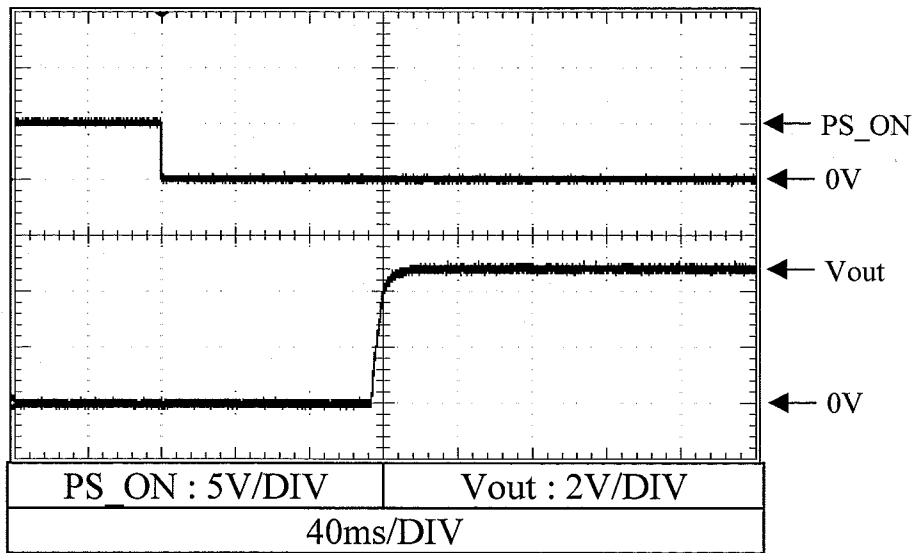

+12V

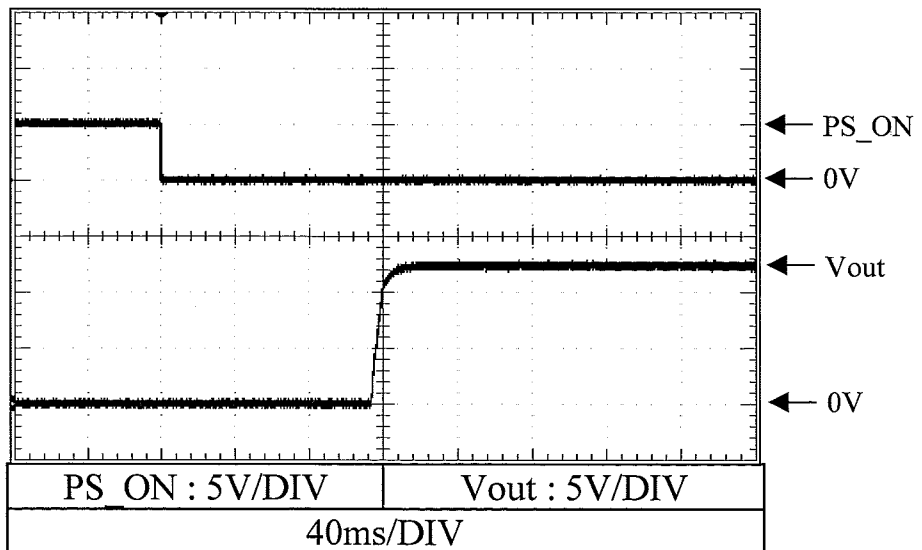

Conditions Vin : 100VAC
Iout : 100%(FL2)
Ta : 25°C

2.7 ON/OFFコントロール時出力立ち上がり特性
Output rise characteristics with ON/OFF CONTROL

-12V

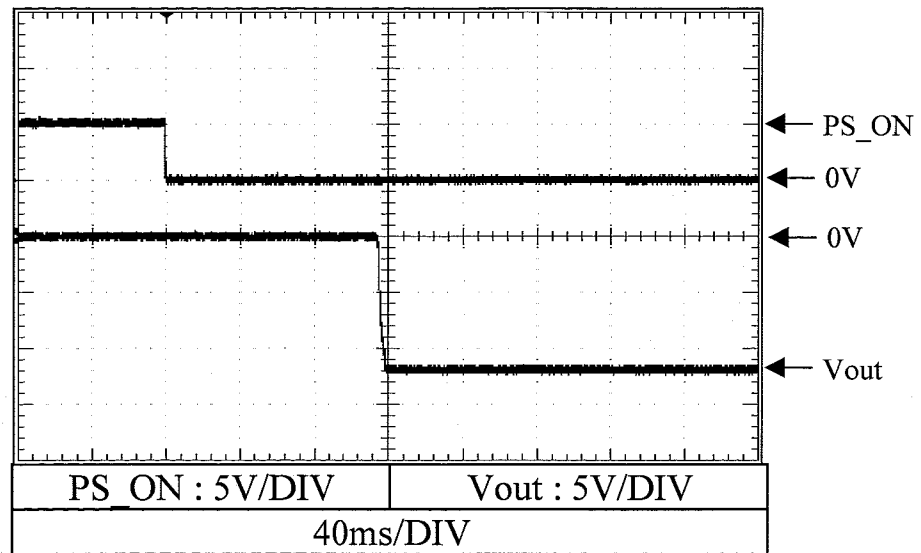

Conditions Vin : 100VAC
 Iout : 100%(FL3)
 Ta : 25°C

2.7 ON/OFFコントロール時出力立ち上がり特性
 Output rise characteristics with ON/OFF CONTROL

+3.3V

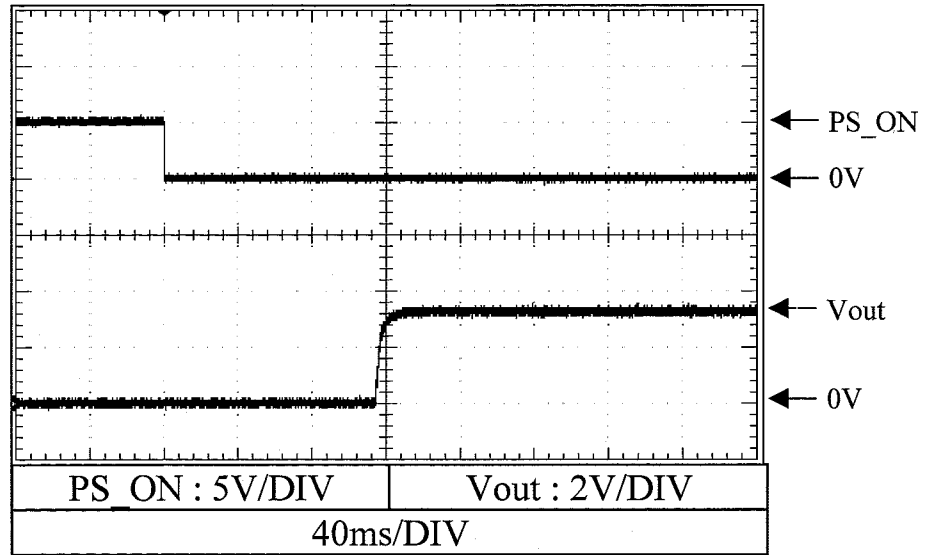

+5V

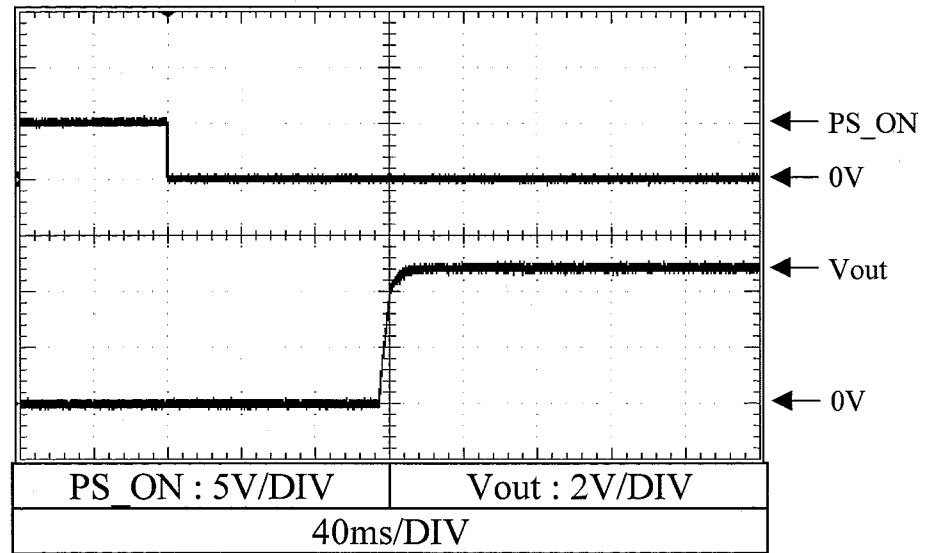

+12V

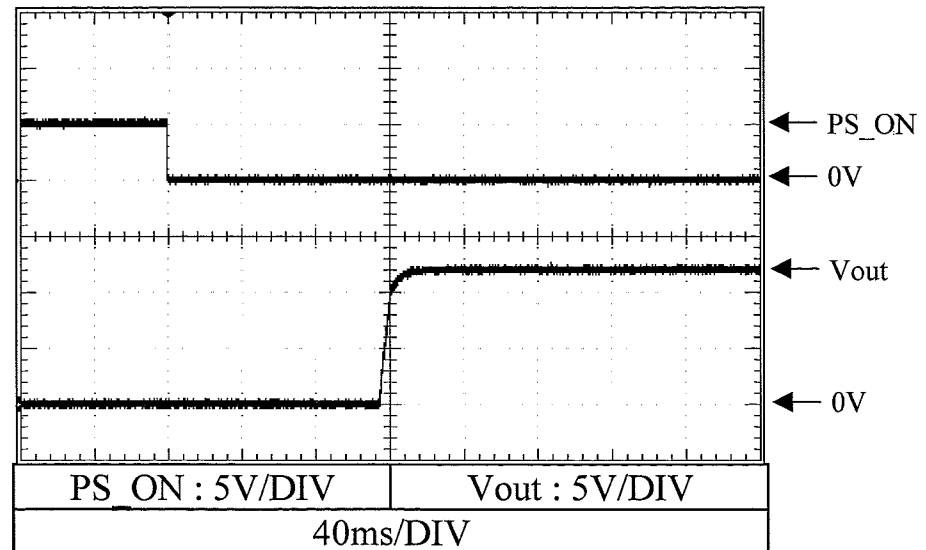

Conditions Vin : 100VAC
 Iout : 100%(FL3)
 Ta : 25°C

2.7 ON/OFFコントロール時出力立ち上がり特性
 Output rise characteristics with ON/OFF CONTROL

-12V

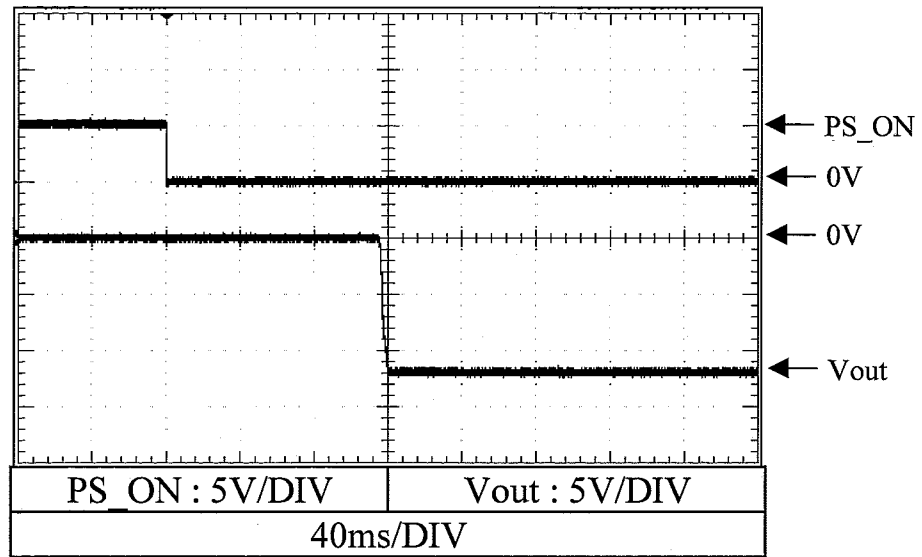

Conditions Vin : 100VAC
 Iout : 100%(FL1)
 Ta : 25°C

2.8 ON/OFFコントロール時出力立ち下がり特性
 Output fall characteristics with ON/OFF CONTROL

+3.3V

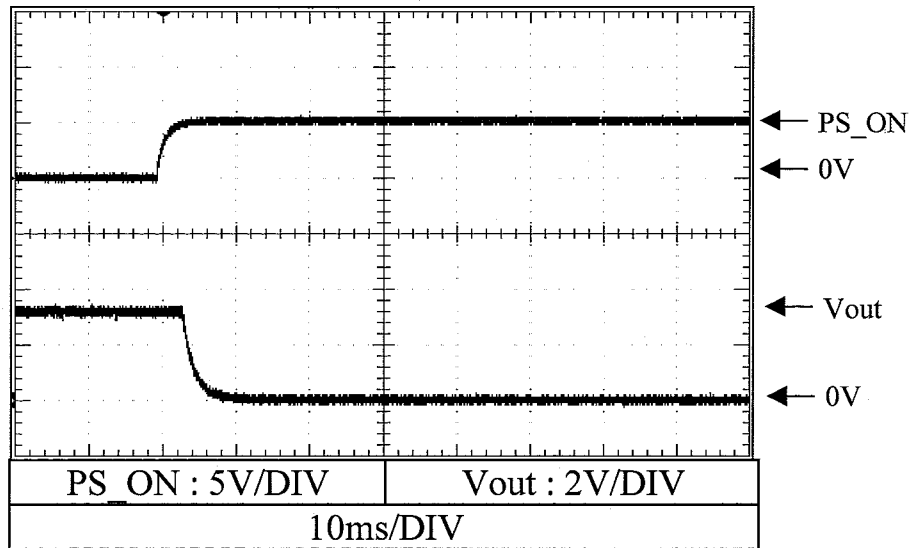

+5V

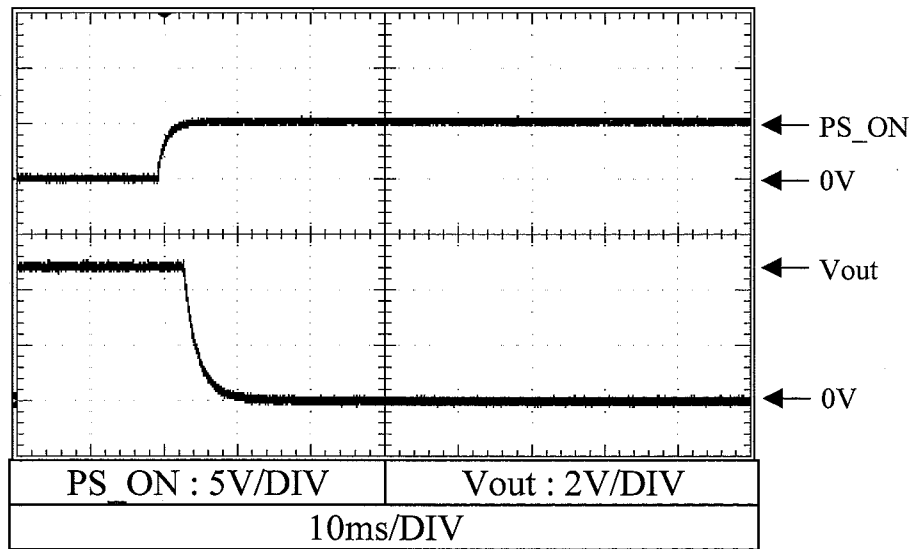

+12V

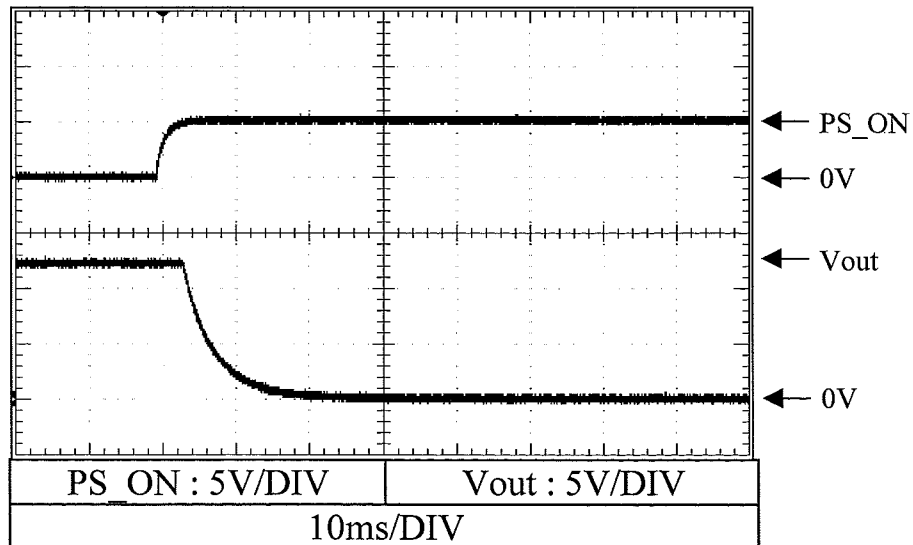

Conditions Vin : 100VAC
 Iout : 100%(FL1)
 Ta : 25°C

2.8 ON/OFFコントロール時出力立ち下がり特性
 Output fall characteristics with ON/OFF CONTROL

-12V

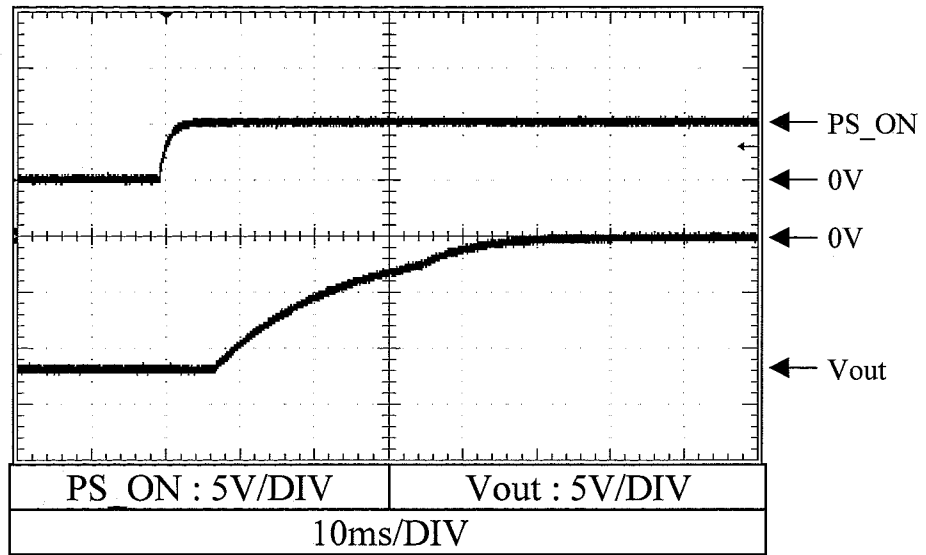

Conditions Vin : 100VAC
 Iout : 100%(FL2)
 Ta : 25°C

2.8 ON/OFFコントロール時出力立ち下がり特性
 Output fall characteristics with ON/OFF CONTROL

+3.3V

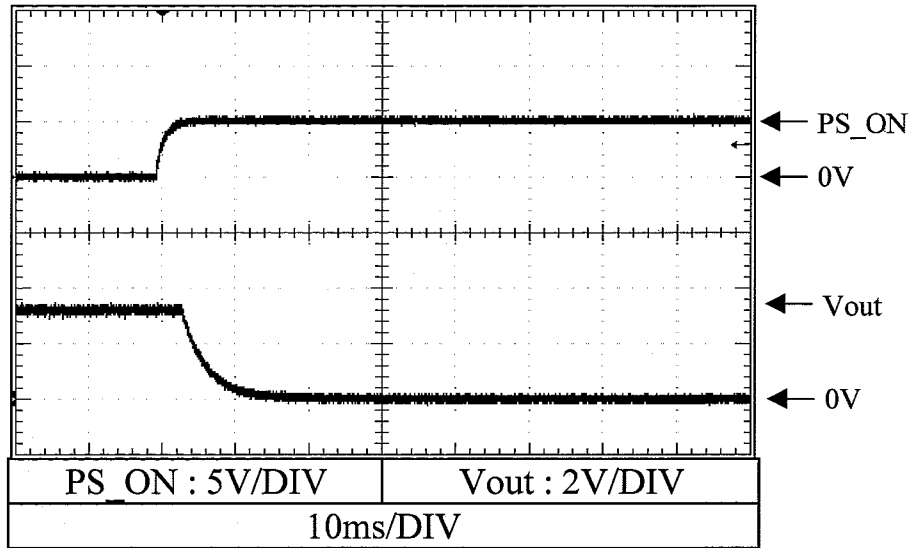

+5V

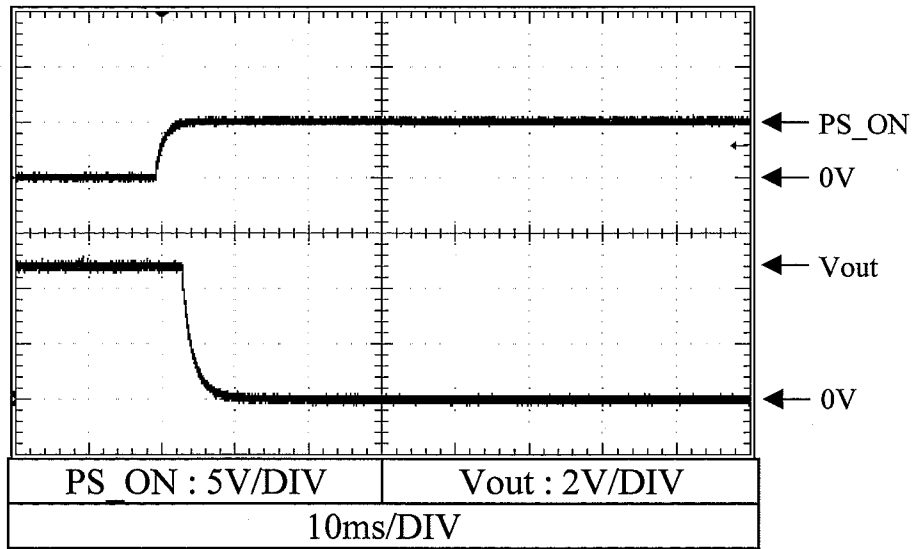

+12V

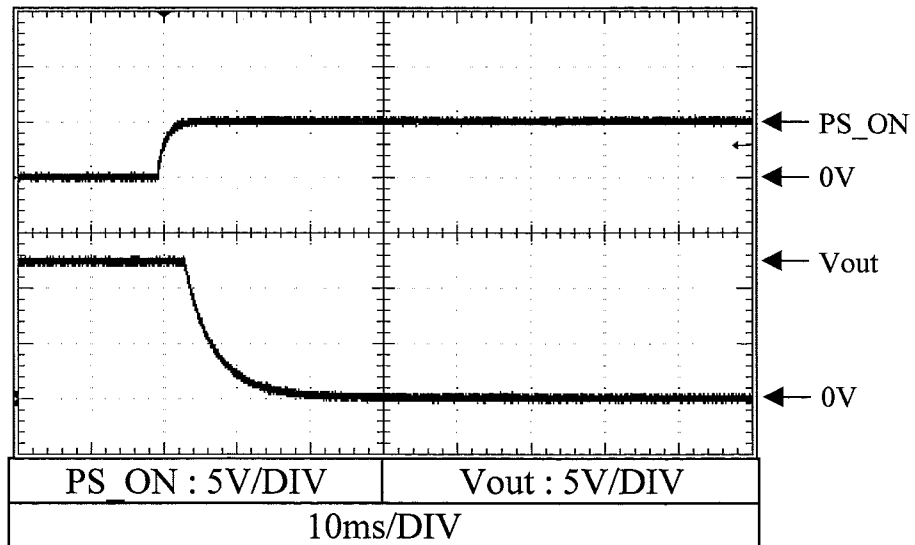

Conditions Vin : 100VAC
Iout : 100%(FL2)
Ta : 25°C

2.8 ON/OFFコントロール時出力立ち下がり特性
Output fall characteristics with ON/OFF CONTROL

-12V

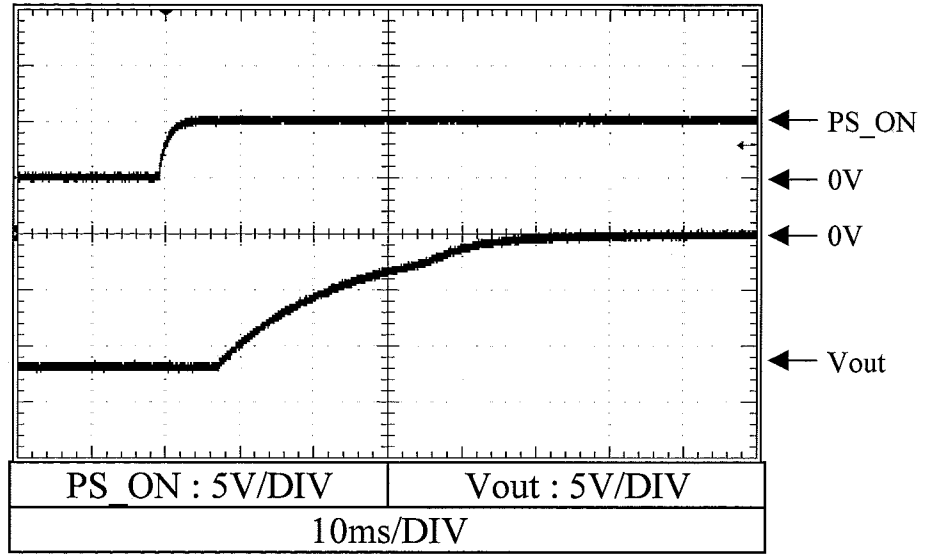

Conditions Vin : 100VAC
 Iout : 100%(FL3)
 Ta : 25°C

2.8 ON/OFFコントロール時出力立ち下がり特性
 Output fall characteristics with ON/OFF CONTROL

+3.3V

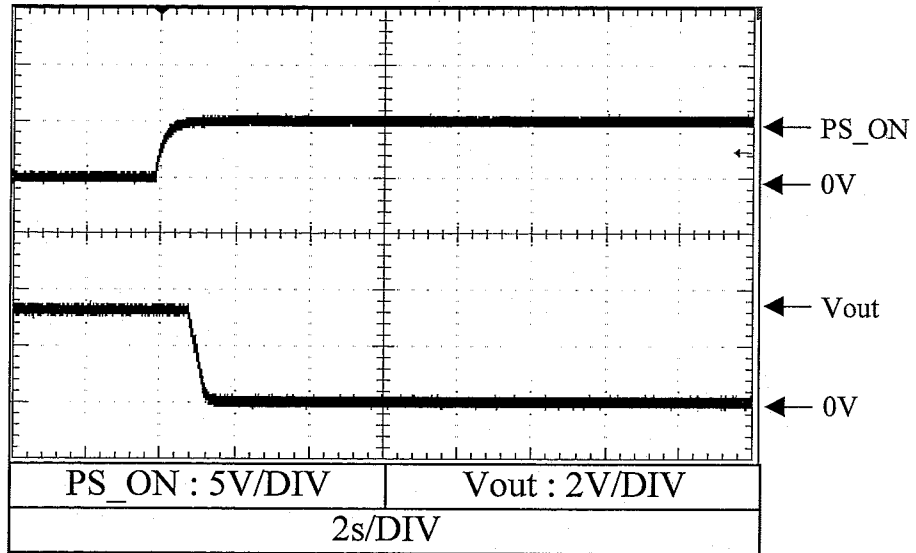

+5V

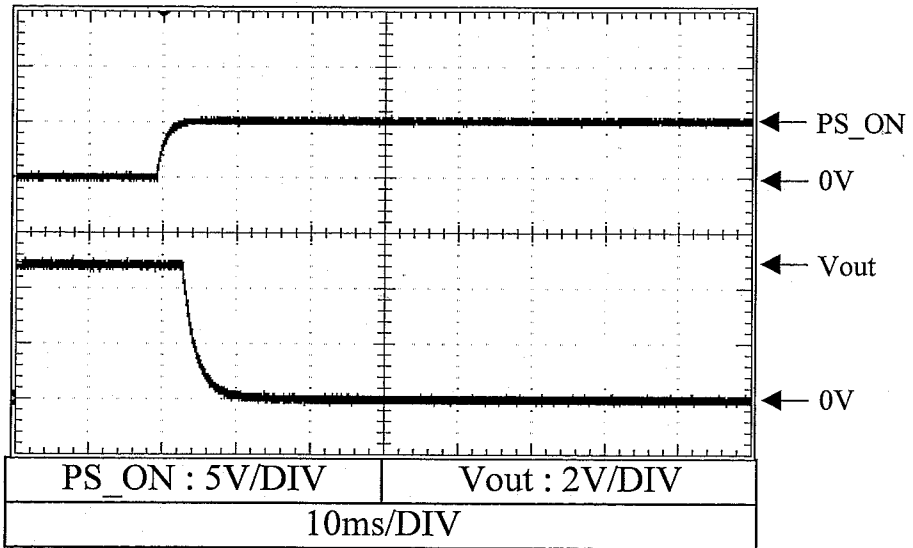

+12V

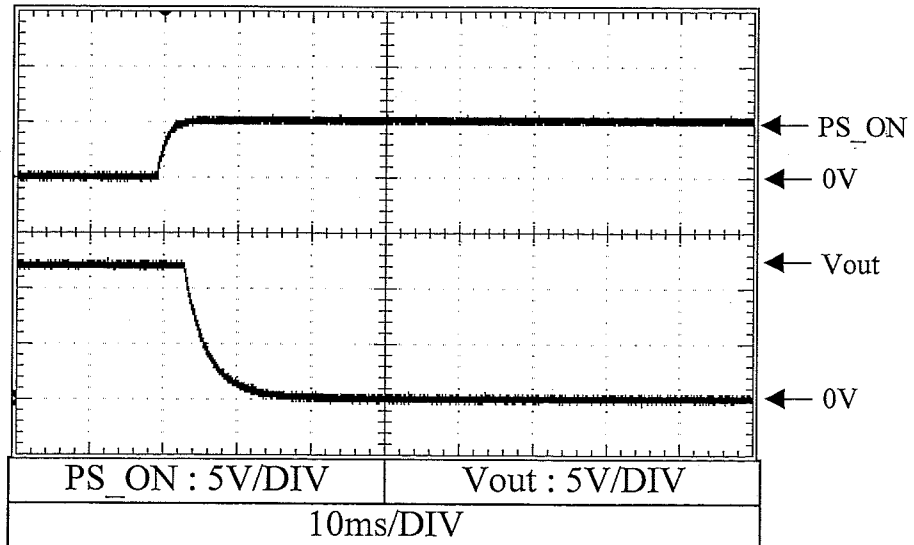

Conditions Vin : 100VAC
Iout : 100%(FL3)
Ta : 25°C

2.8 ON/OFFコントロール時出力立ち下がり特性
Output fall characteristics with ON/OFF CONTROL

-12V

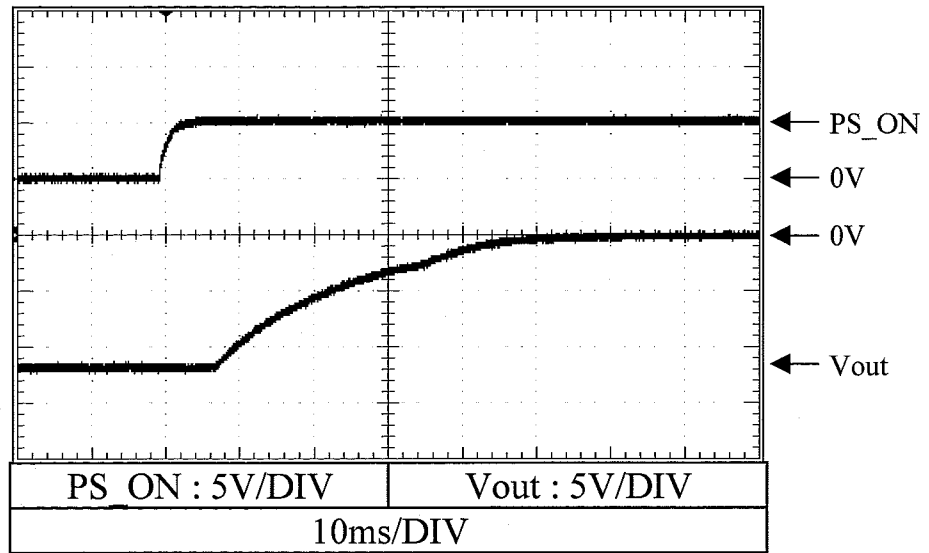

2.9 出力保持時間特性
Hold up time characteristics

Conditions Vin : 100VAC ———
200VAC - - - - -

Ta : 25°C

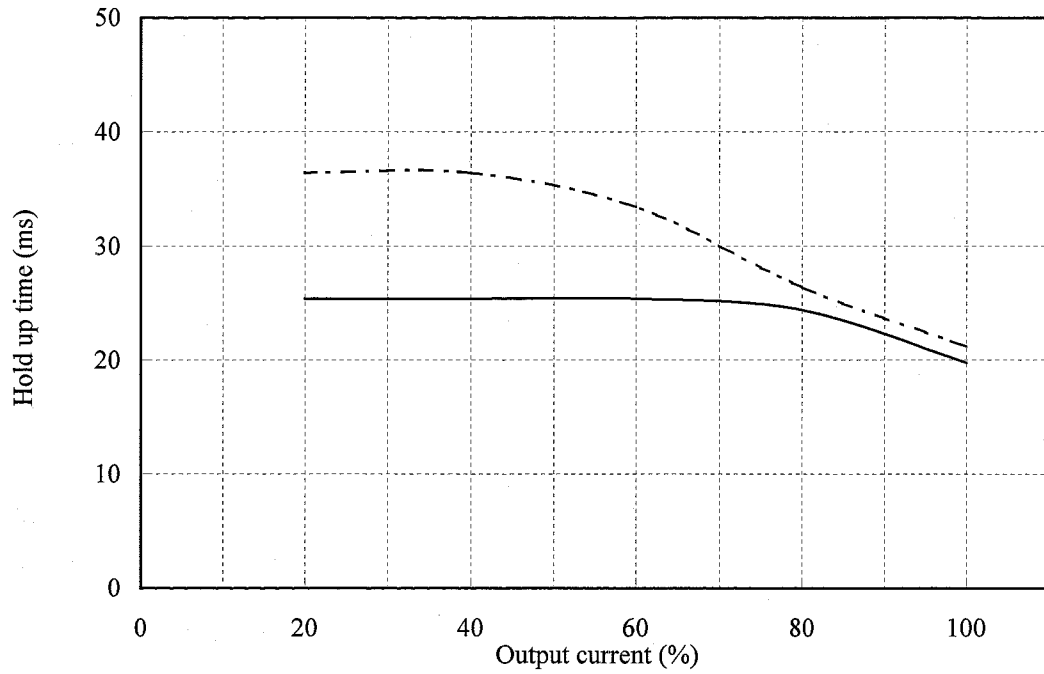

2.10 過渡応答 (入力急変) 特性
 Dynamic line response characteristics

Conditions Ta : 25°C
 Iout : 100%(FL1)

+3.3V

Vin : 85V⇔132VAC

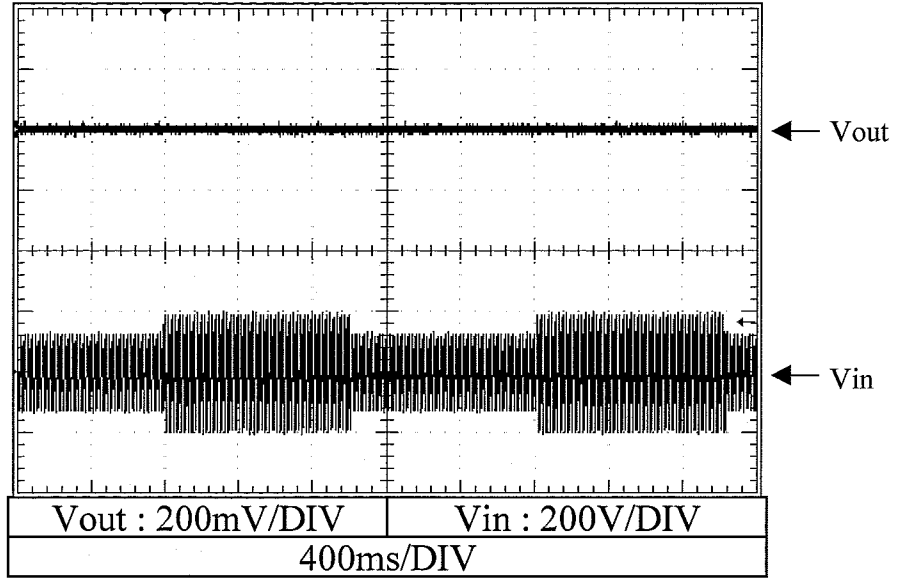

Vin : 170V⇔265VAC

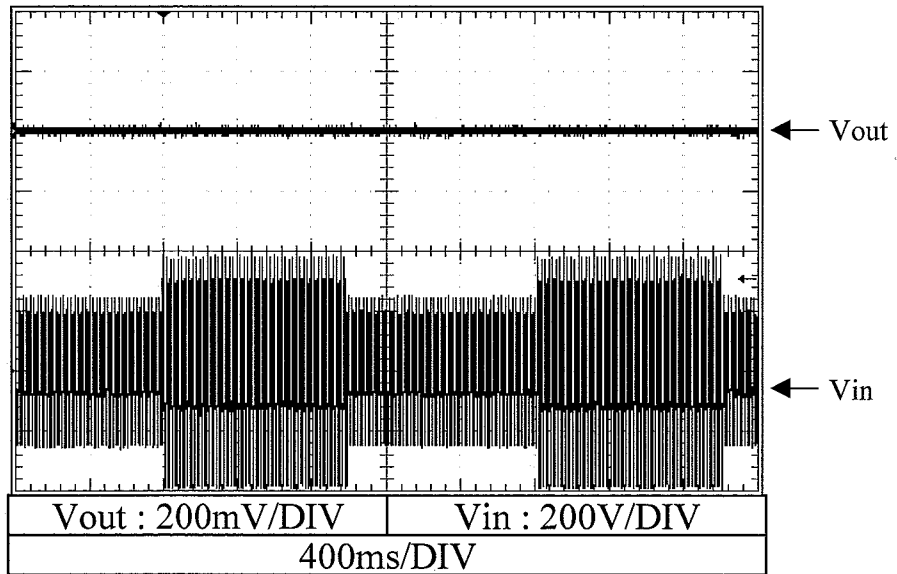

2.10 過渡応答 (入力急変) 特性
Dynamic line response characteristics

Conditions Ta : 25°C
Iout : 100%(FL1)

+5V

Vin : 85V⇔132VAC

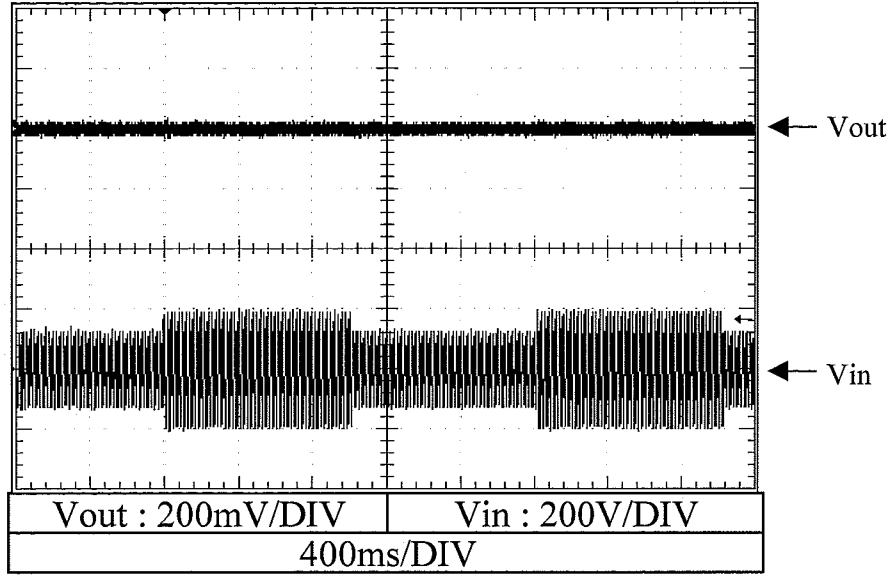

Vin : 170V⇔265VAC

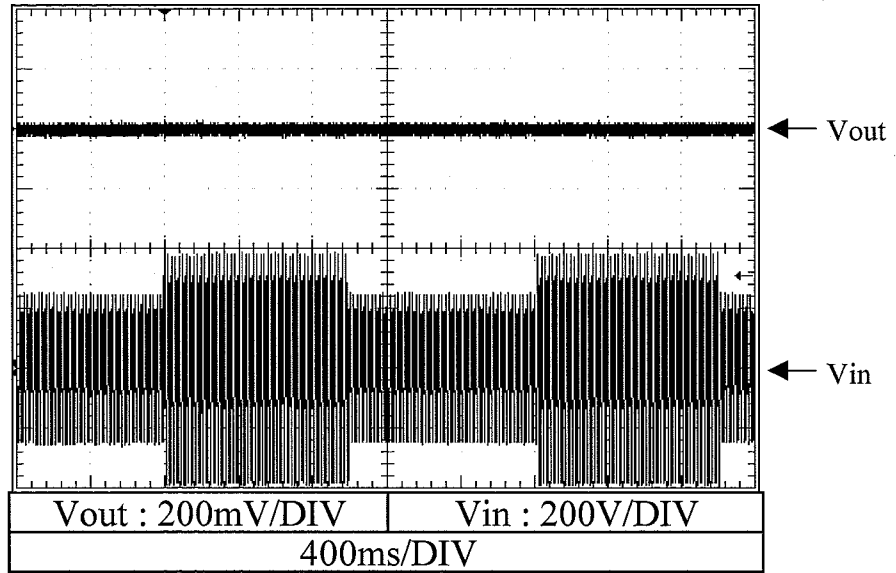

2.10 過渡応答 (入力急変) 特性
 Dynamic line response characteristics

Conditions Ta : 25°C
 Iout : 100%(FL1)

+12V

Vin : 85V⇔132VAC

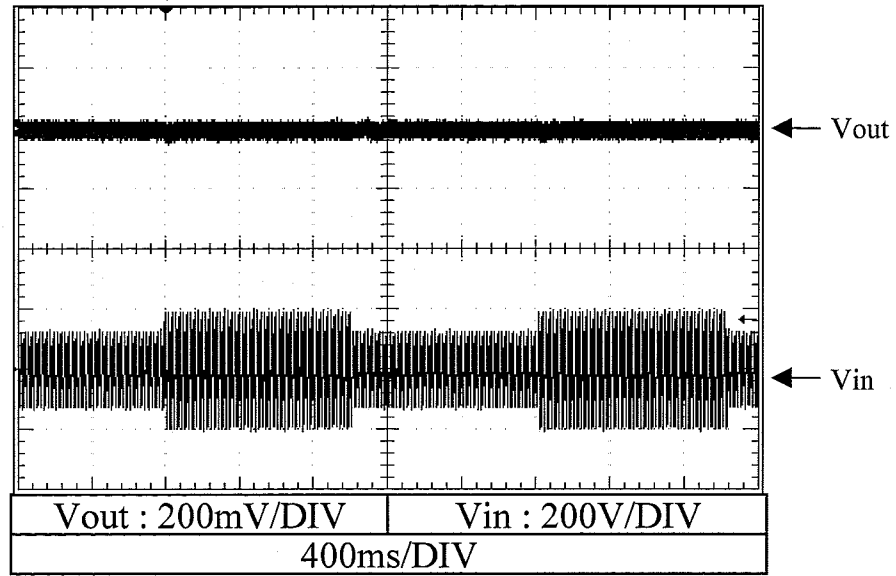

Vin : 170V⇔265VAC

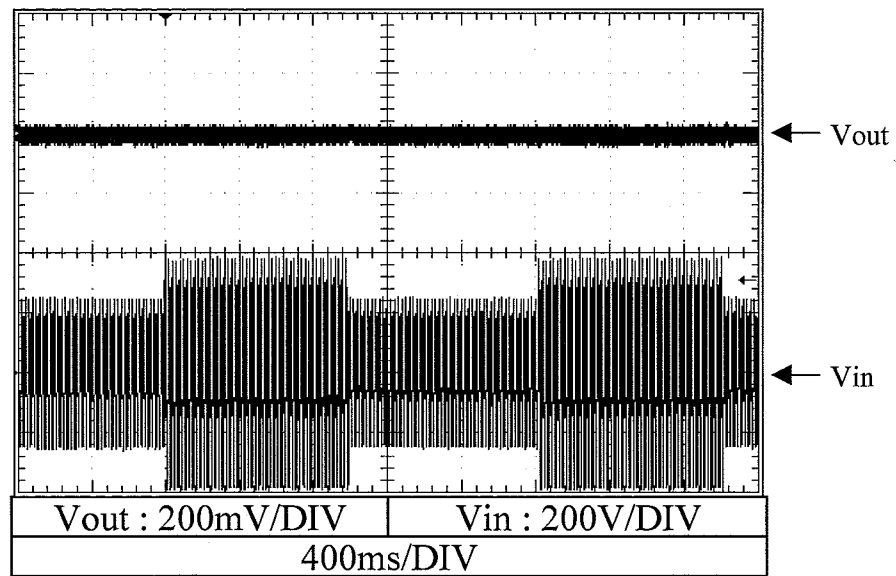

2.10 過渡応答 (入力急変) 特性
 Dynamic line response characteristics

Conditions Ta : 25°C
 Iout : 100%(FL1)

-12V

Vin : 85V⇔132VAC

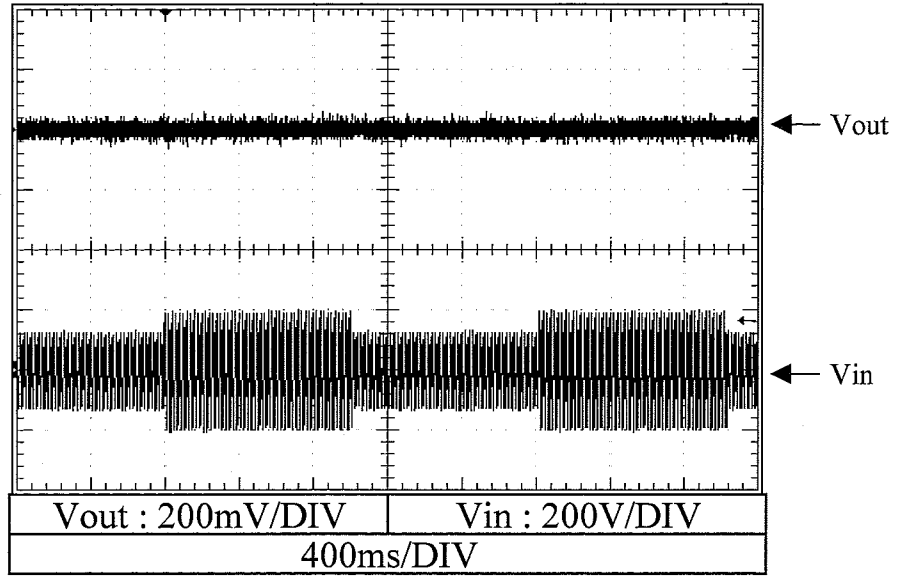

Vin : 170V⇔265VAC

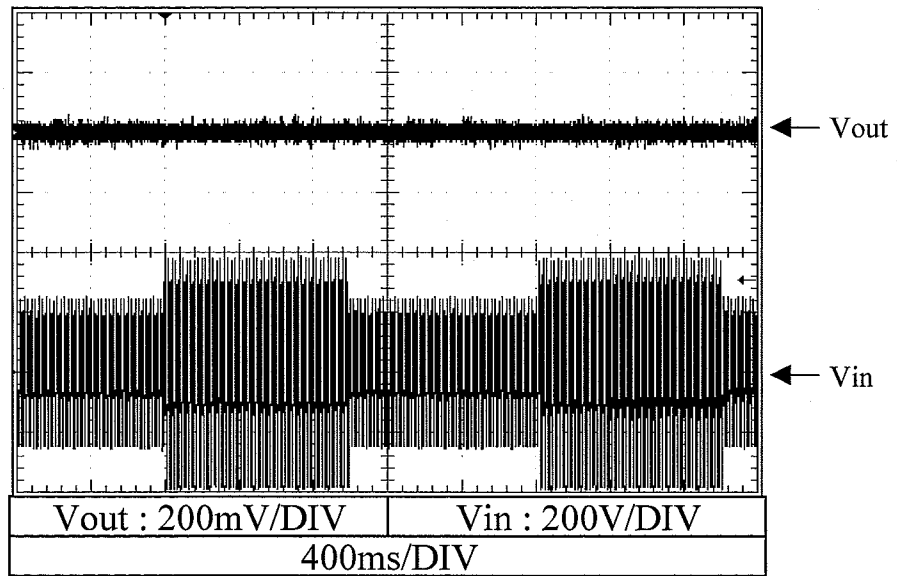

2.10 過渡応答 (入力急変) 特性
 Dynamic line response characteristics

Conditions Ta : 25°C
 Iout : 100%(FL1)

+5VSB

Vin : 85V⇔132VAC

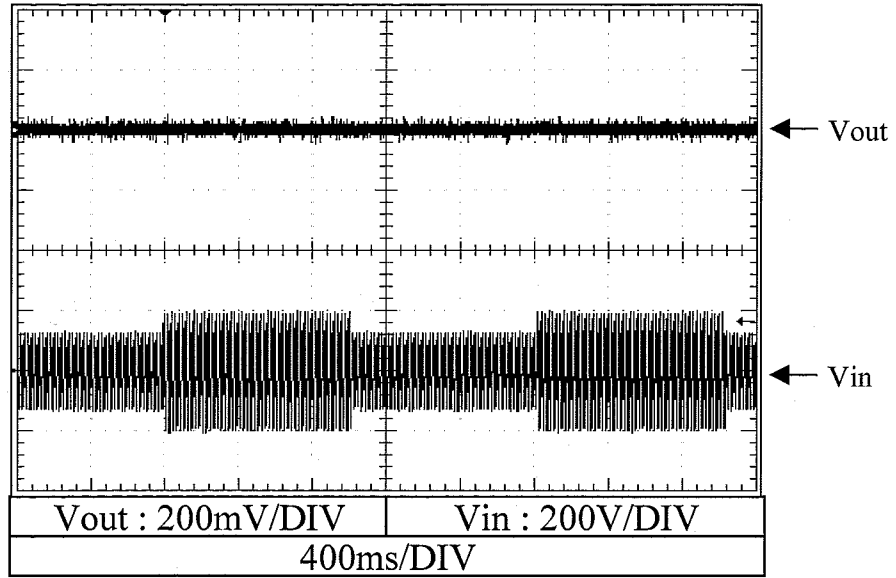

Vin : 170V⇔265VAC

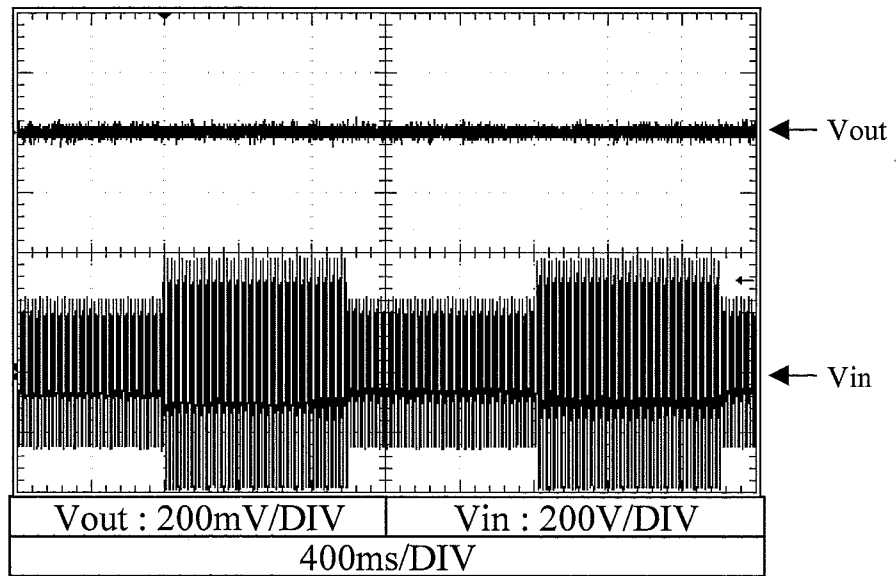

2.10 過渡応答 (入力急変) 特性
 Dynamic line response characteristics

Conditions Ta : 25°C
 Iout : 100%(FL1)

+5VSB(Standby)

Vin : 85V⇔132VAC

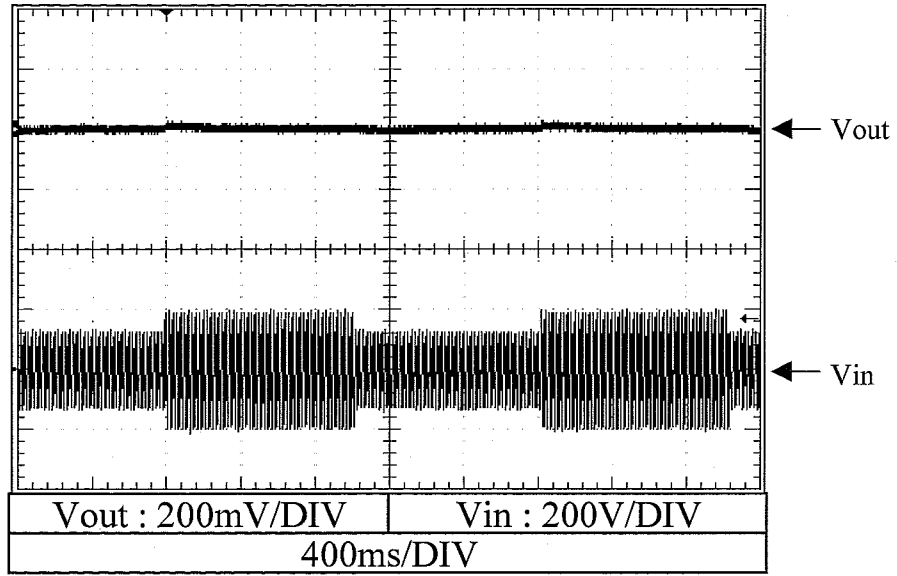

Vin : 170V⇔265VAC

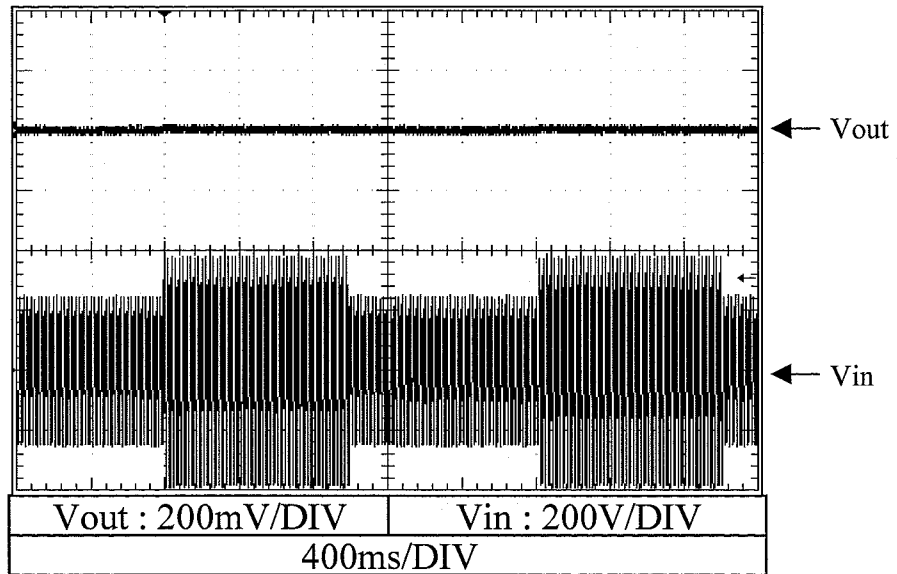

2.11 過渡応答 (負荷急変) 特性
Dynamic load response characteristics

Conditions V_{in} : 100VAC
 T_a : 25°C

+3.3V

$f=100\text{Hz}$

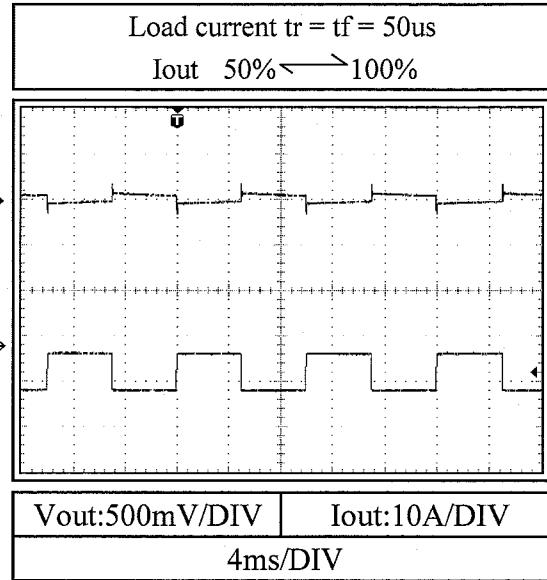
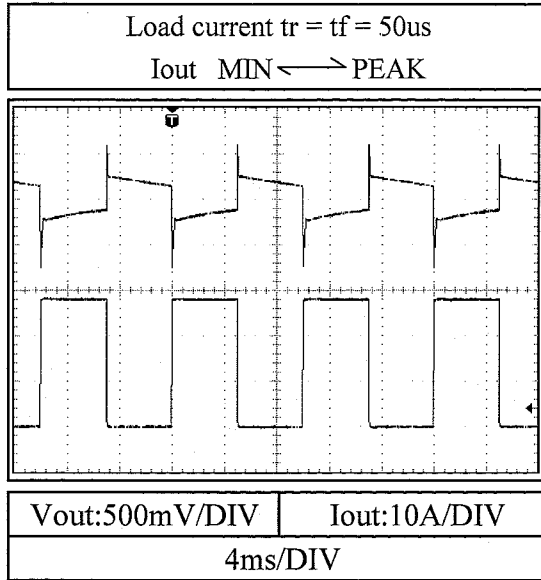

$f=1\text{kHz}$

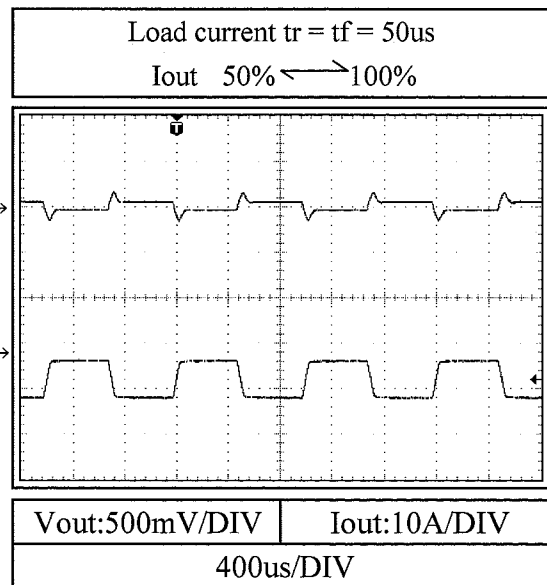
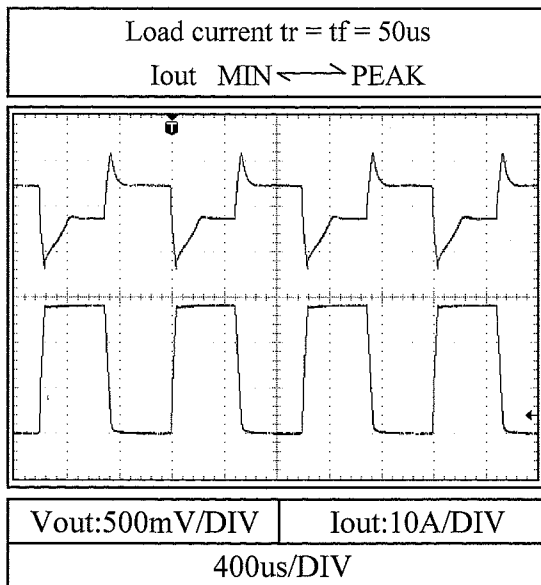

2.11 過渡応答（負荷急変）特性
Dynamic load response characteristics

Conditions Vin : 240VAC
Ta : 25°C

+3.3V

f=100Hz

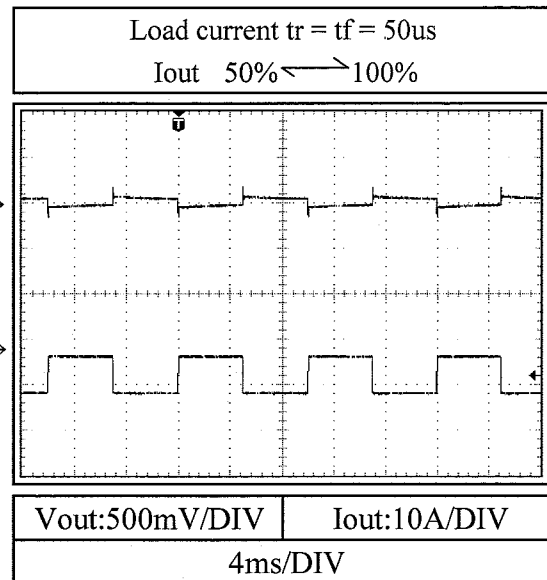
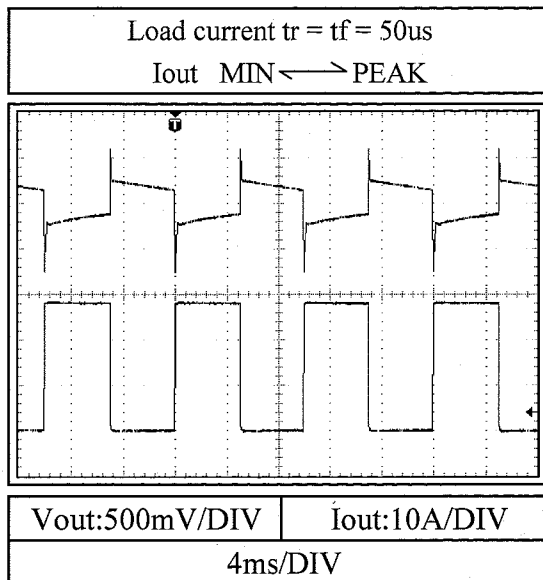

f=1kHz

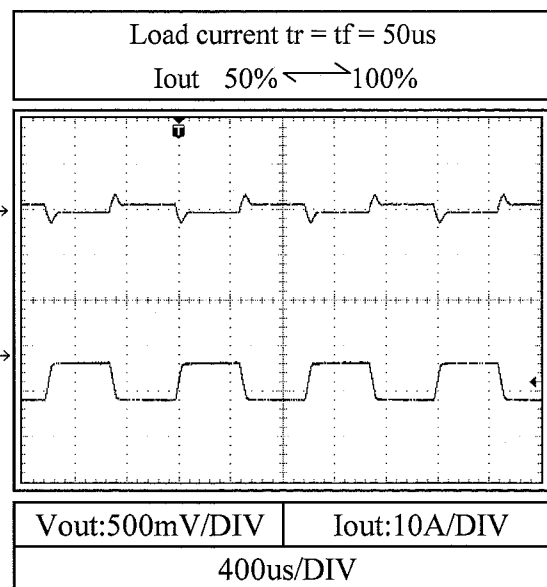
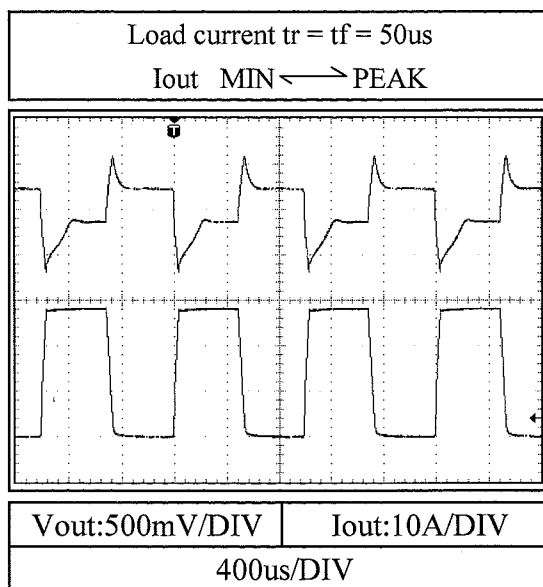

2.11 過渡応答（負荷急変）特性
Dynamic load response characteristics

Conditions Vin : 100VAC
Ta : 25°C

+5V

f=100Hz

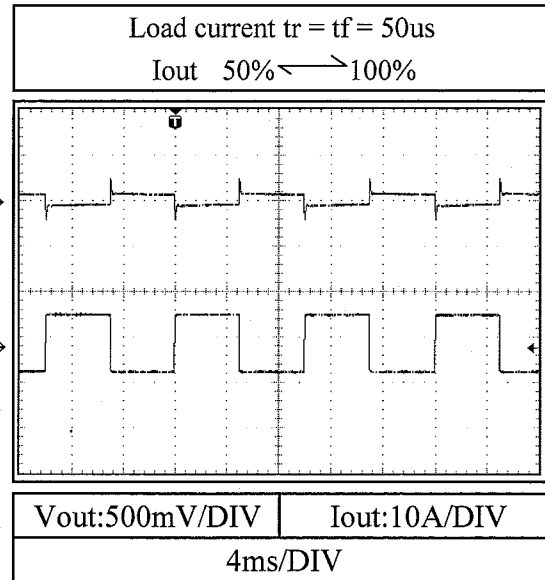
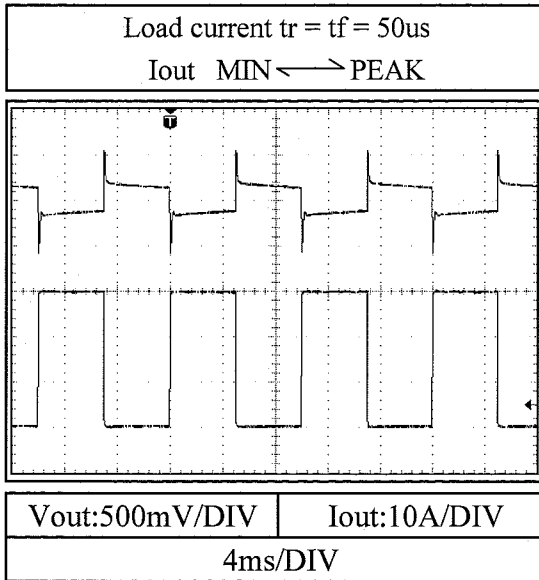

f=1kHz

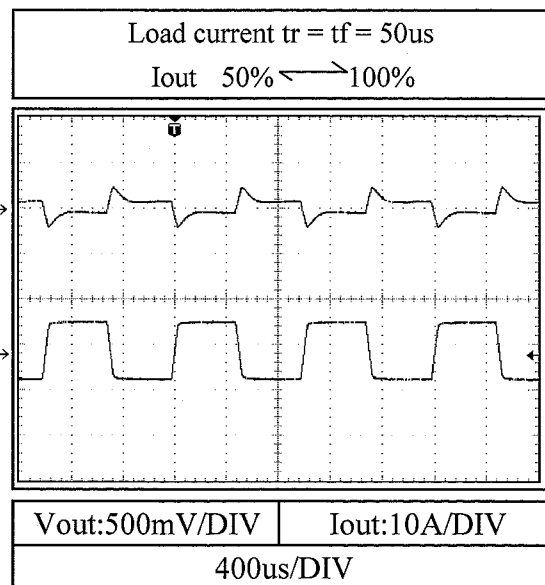
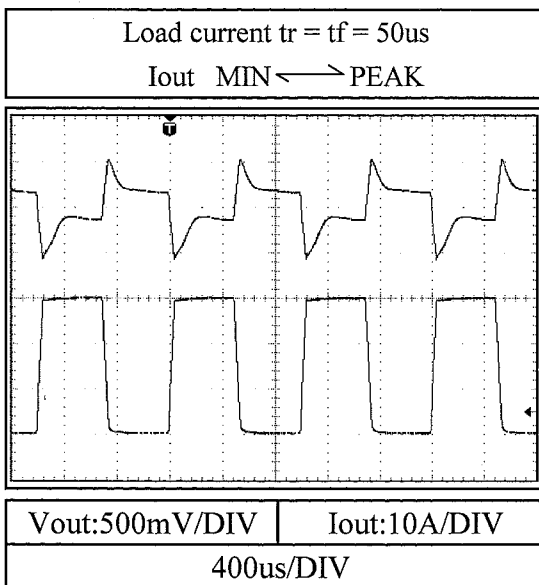

2.11 過渡応答（負荷急変）特性
Dynamic load response characteristics

Conditions V_{in} : 240VAC
 T_a : 25°C

+5V

$f=100\text{Hz}$

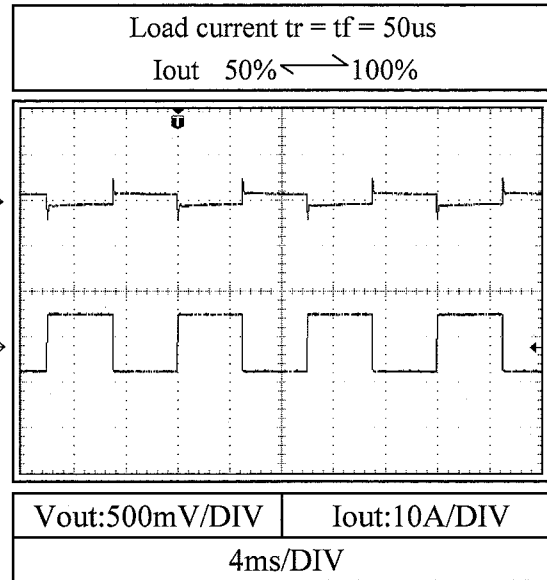
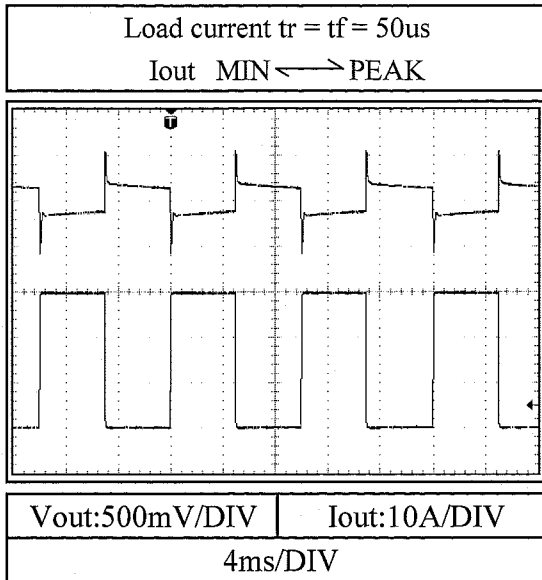

$f=1\text{kHz}$

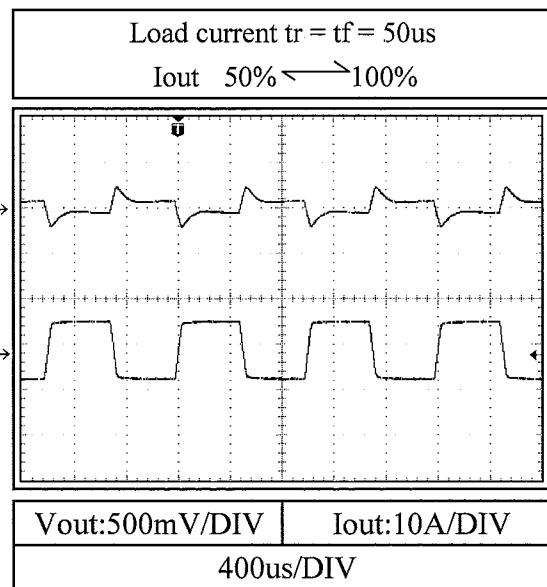
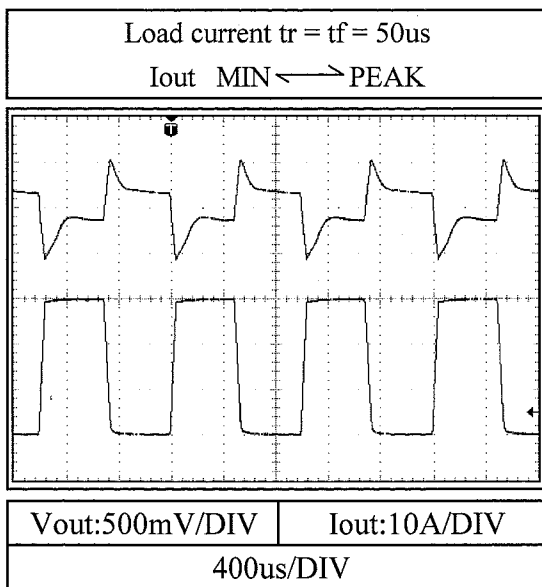

2.11 過渡応答 (負荷急変) 特性
Dynamic load response characteristics

Conditions Vin : 100VAC
Ta : 25°C

+12V

f=100Hz

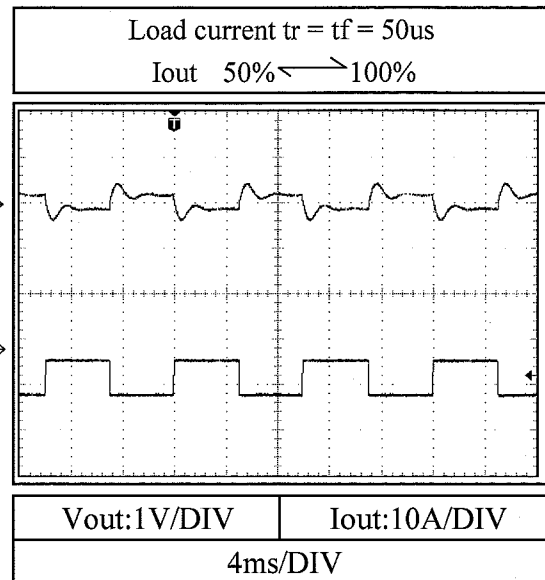
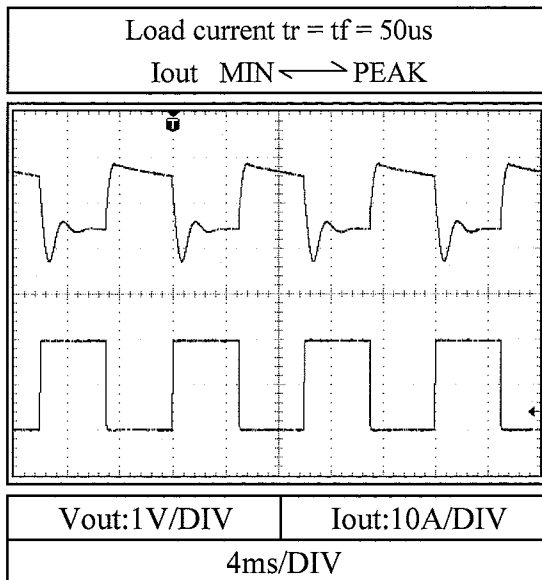

f=1kHz

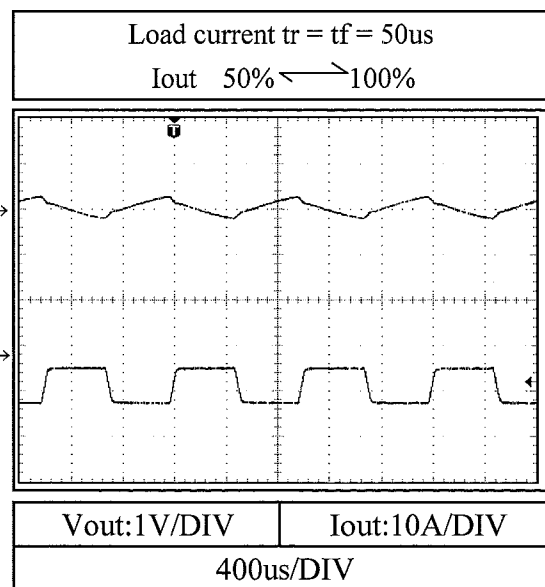
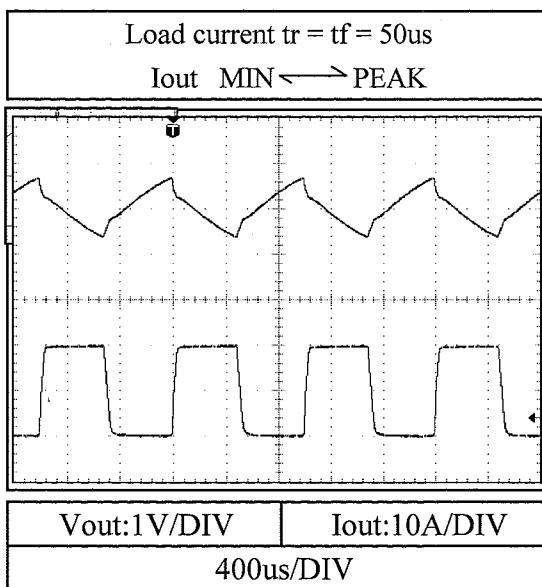

2.11 過渡応答 (負荷急変) 特性
Dynamic load response characteristics

Conditions Vin : 240VAC
Ta : 25°C

+12V

f=100Hz

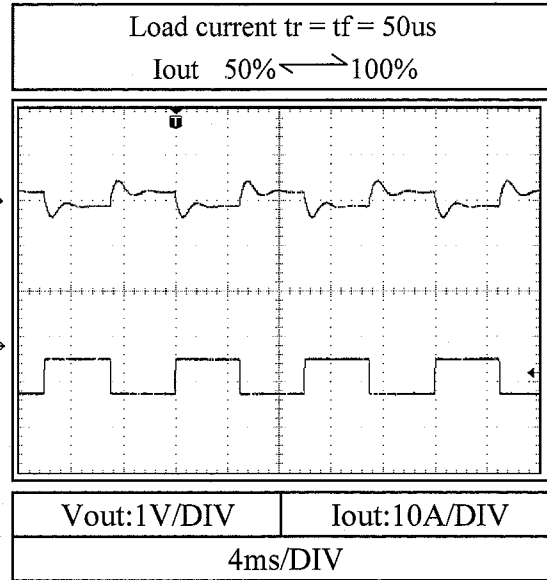
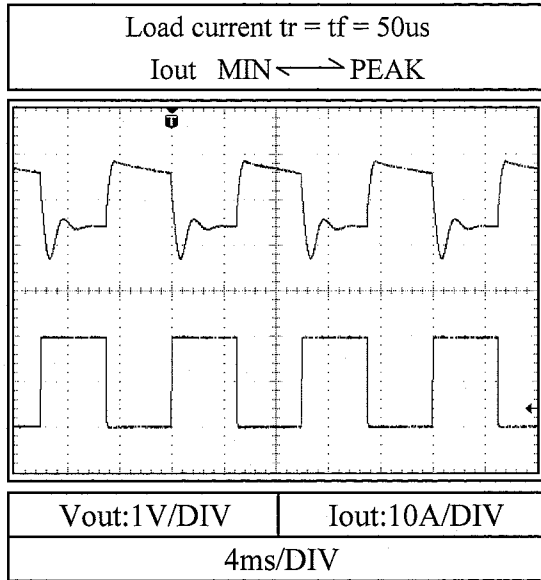

f=1kHz

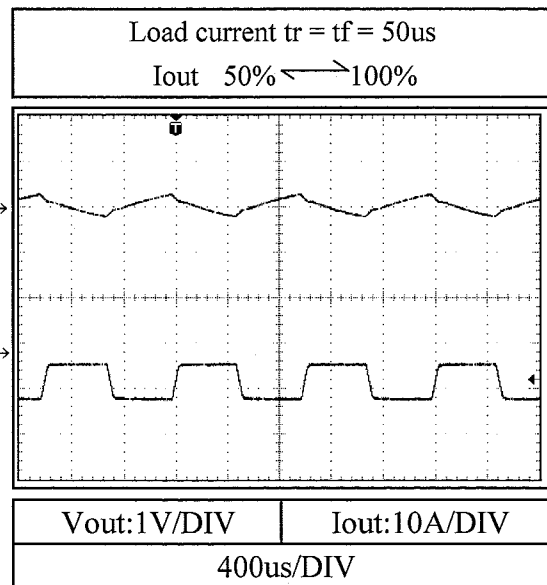
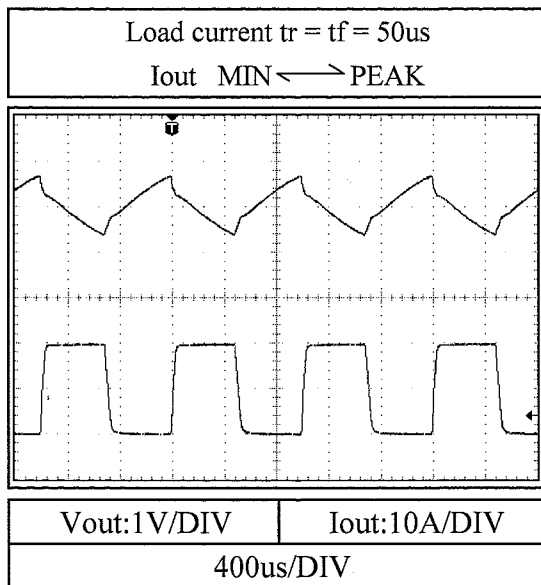

2.11 過渡応答 (負荷急変) 特性
Dynamic load response characteristics

Conditions Vin : 100VAC
Ta : 25°C

-12V

f=100Hz

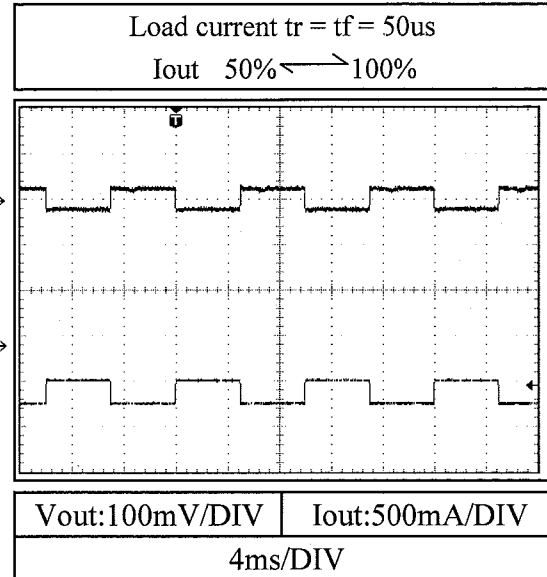
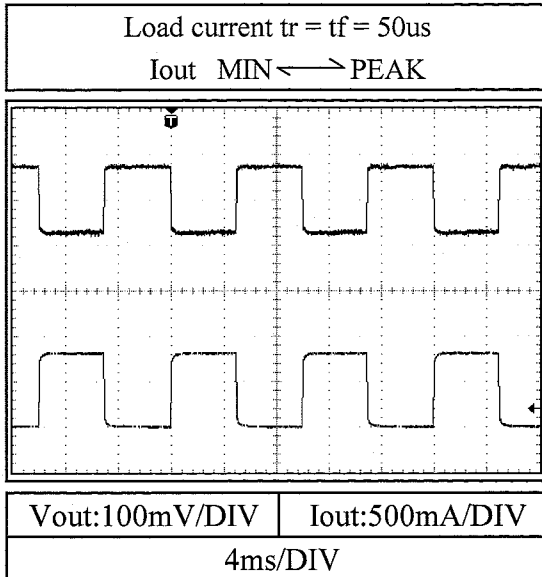

f=1kHz

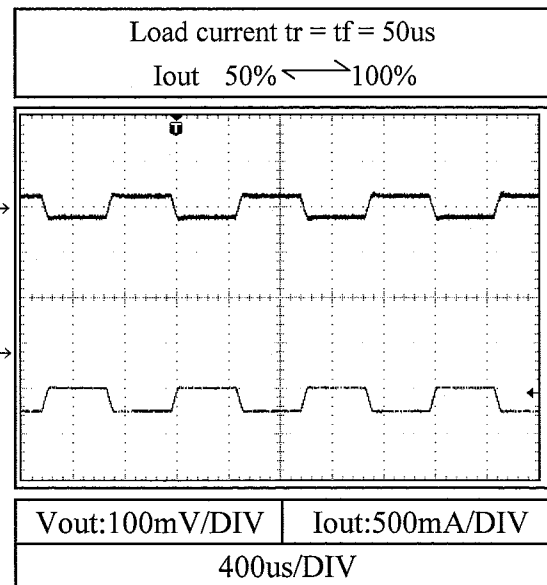
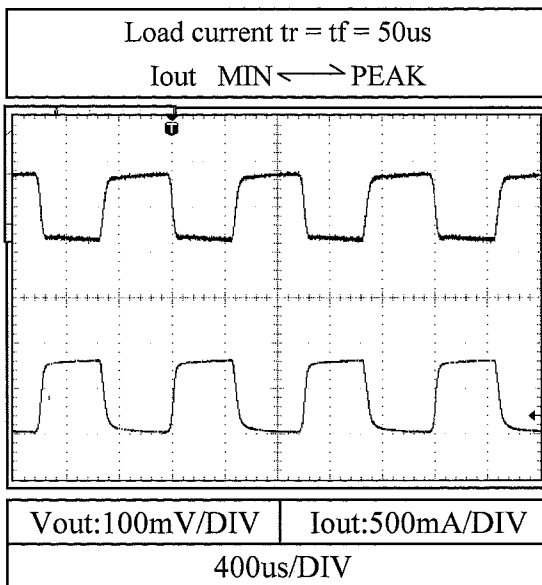

2.11 過渡応答 (負荷急変) 特性
Dynamic load response characteristics

Conditions Vin : 240VAC
Ta : 25°C

-12V

f=100Hz

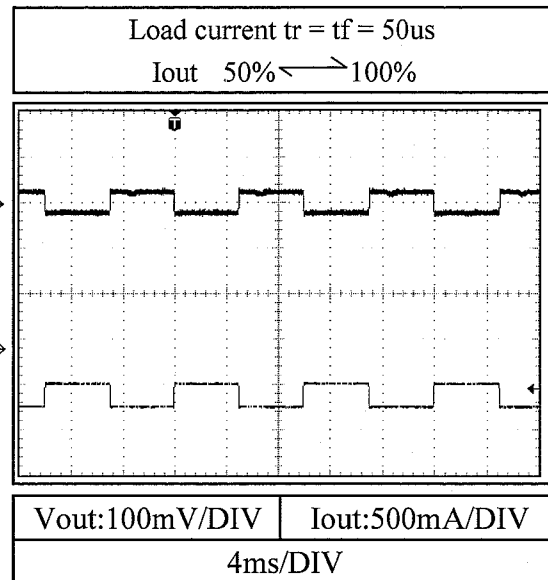
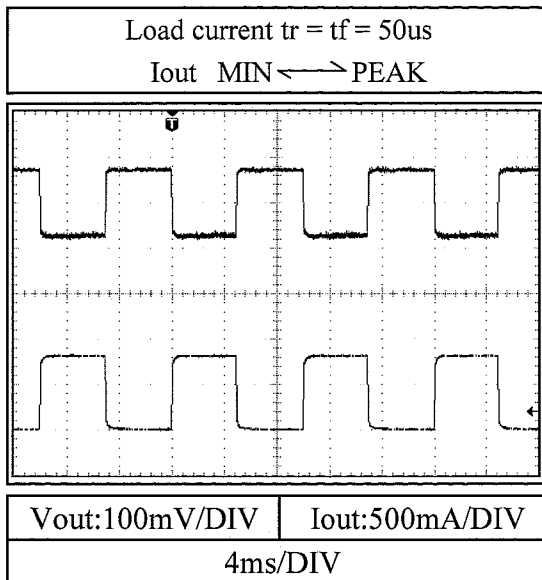

f=1kHz

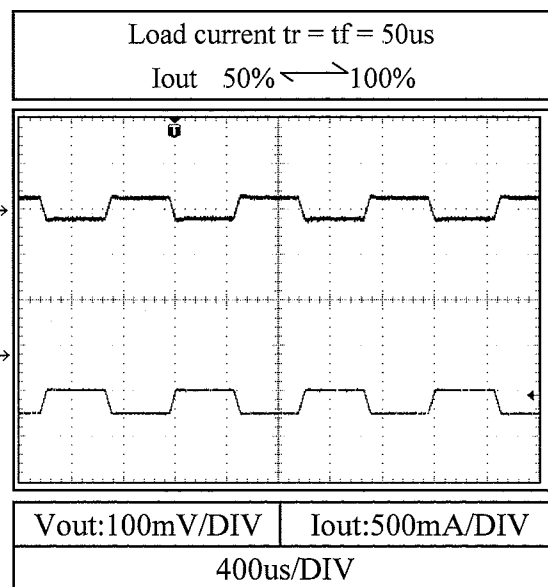
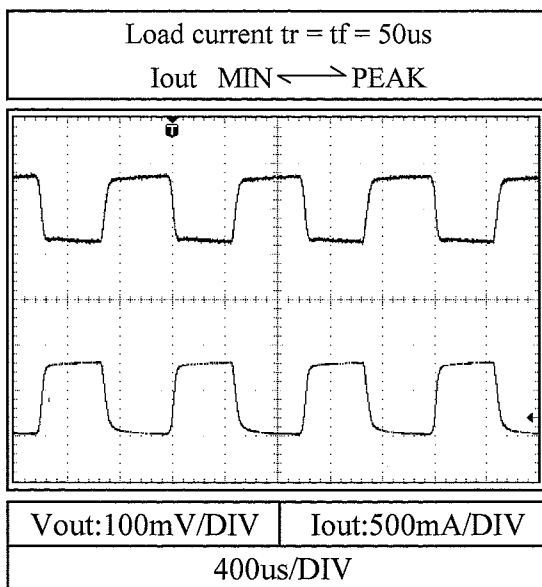

2.11 過渡応答 (負荷急変) 特性
Dynamic load response characteristics

Conditions V_{in} : 100VAC
 T_a : 25°C

5VSB · PS_ON

$f=100\text{Hz}$

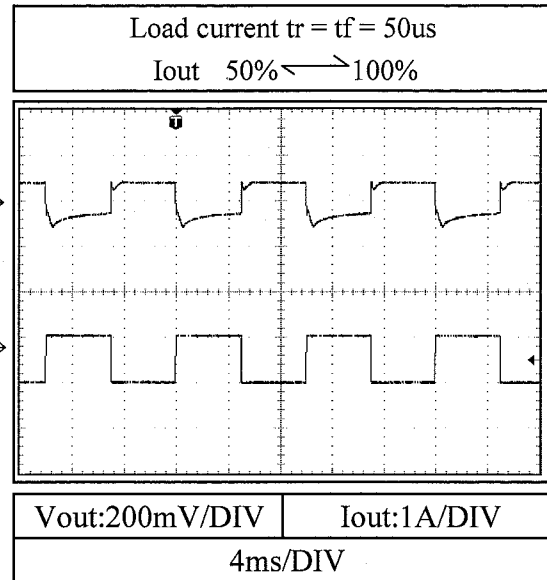
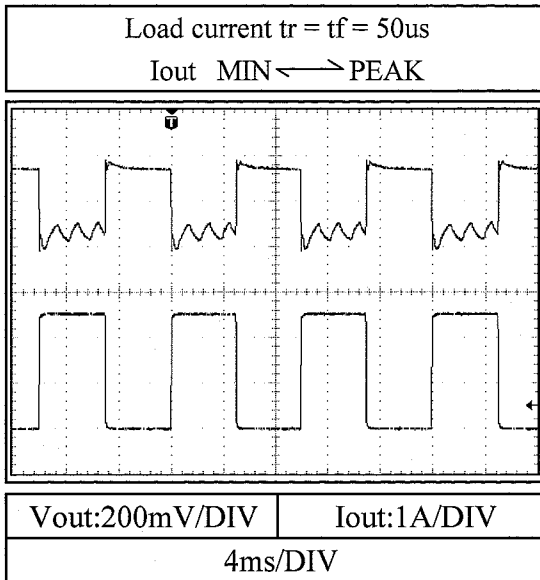

$f=1\text{kHz}$

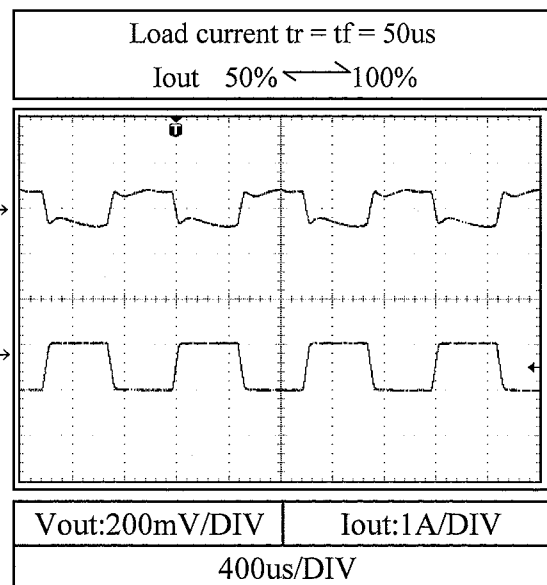
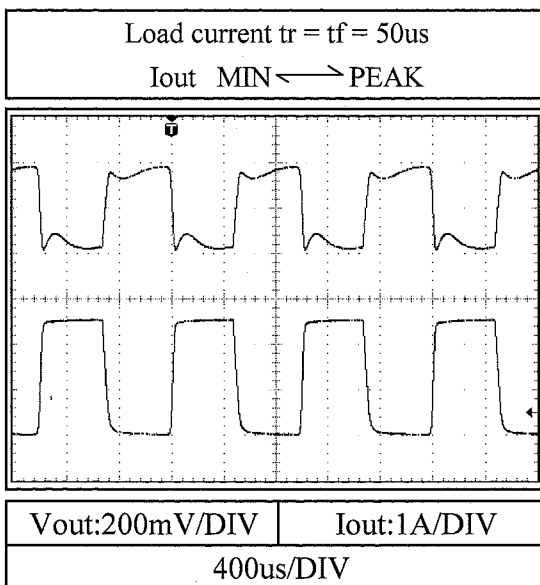

2.11 過渡応答（負荷急変）特性
Dynamic load response characteristics

Conditions Vin : 240VAC
Ta : 25°C

5VSB PS_ON

f=100Hz

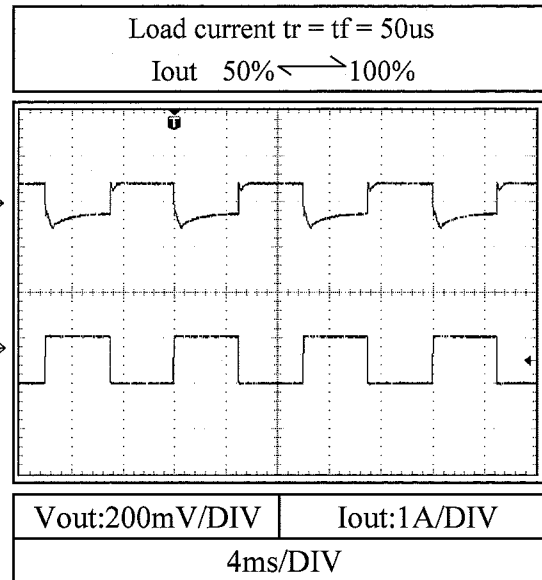
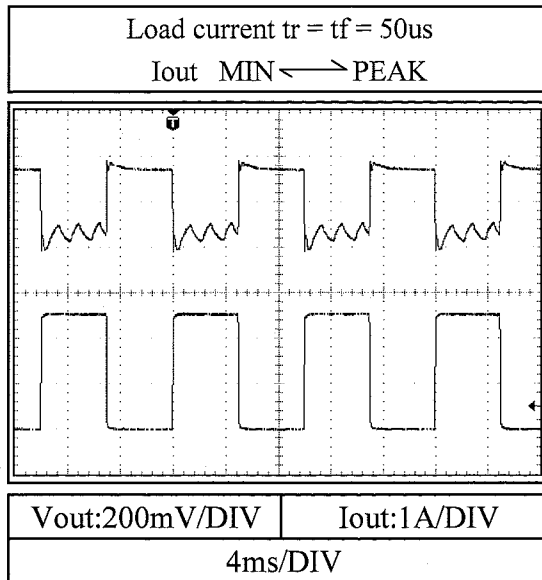

f=1kHz

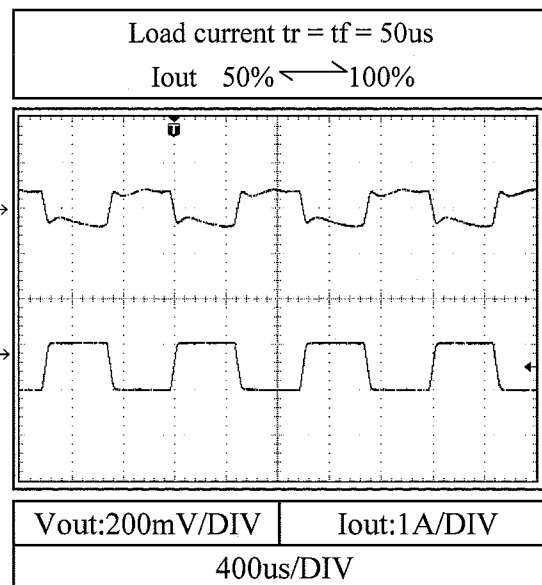
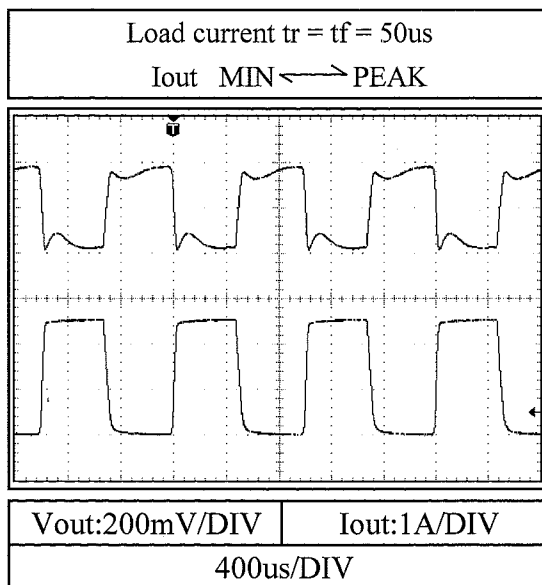

2.11 過渡応答 (負荷急変) 特性
Dynamic load response characteristics

Conditions Vin : 85VAC
Ta : 25°C

5VSB PS_OFF

f=100Hz

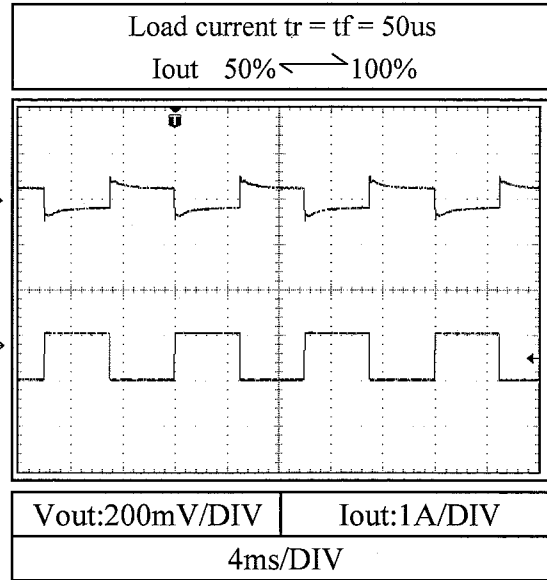
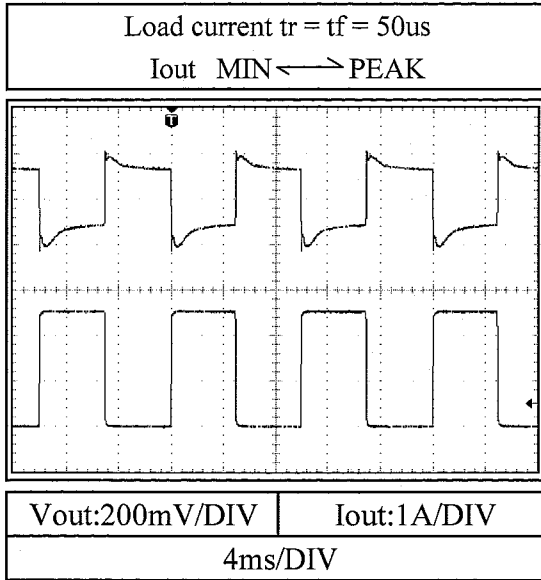

f=1kHz

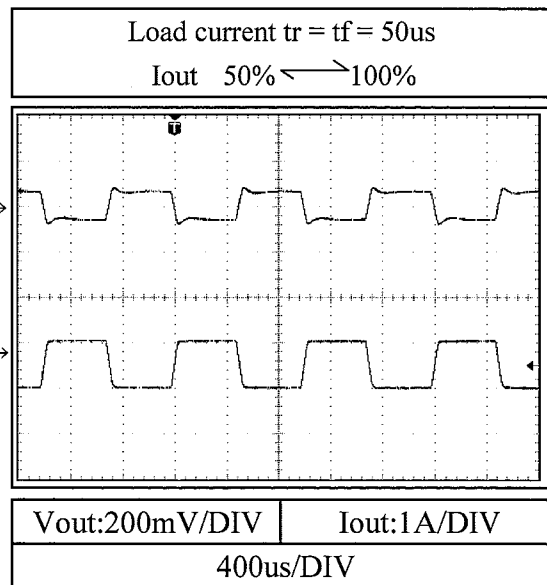
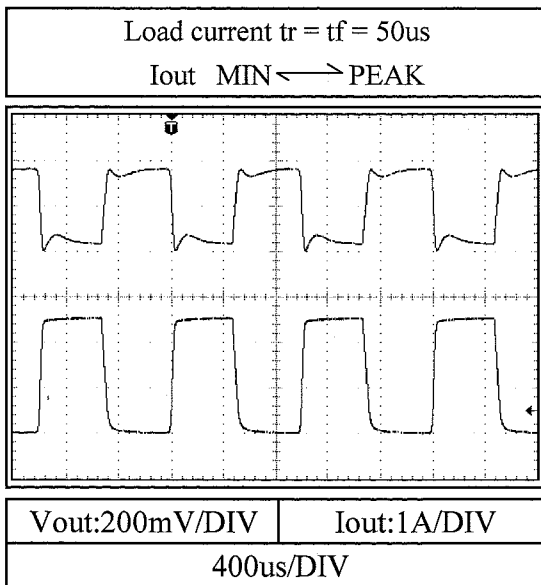

2.11 過渡応答 (負荷急変) 特性
Dynamic load response characteristics

Conditions Vin : 265VAC
Ta : 25°C

5VSB PS_OFF

f=100Hz

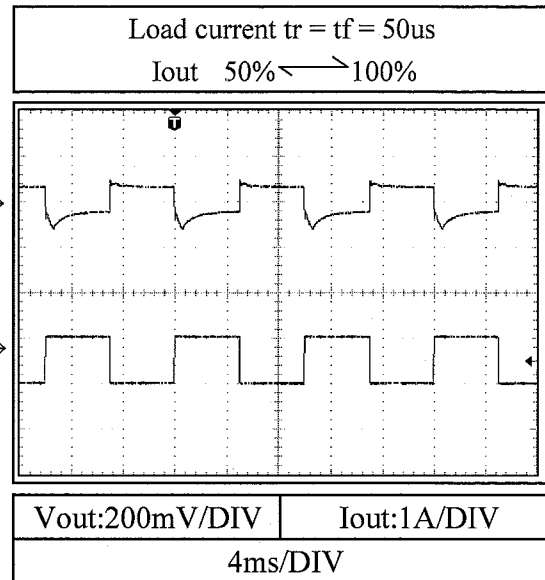
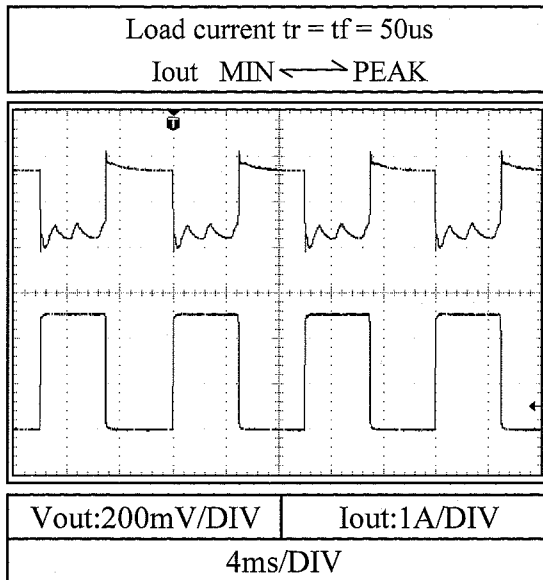

f=1kHz

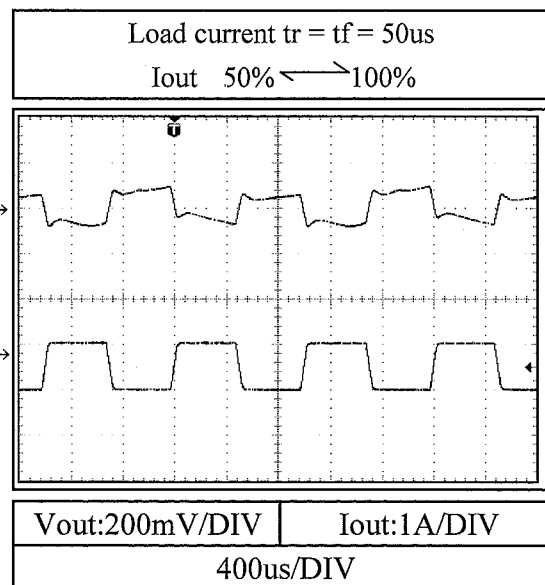
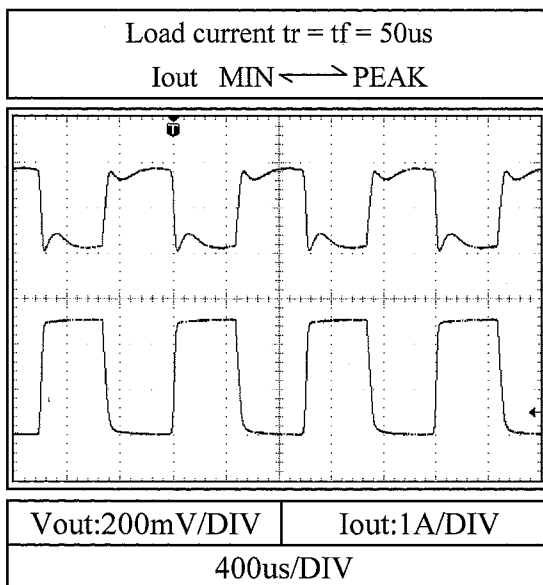

2.12 入力電圧瞬停特性
Momentary line voltage drop characteristics

Conditions Ta : 25°C
Iout : 100%(FL1)
Vin : 115V⇔0VAC
Time: 20ms

+3.3V

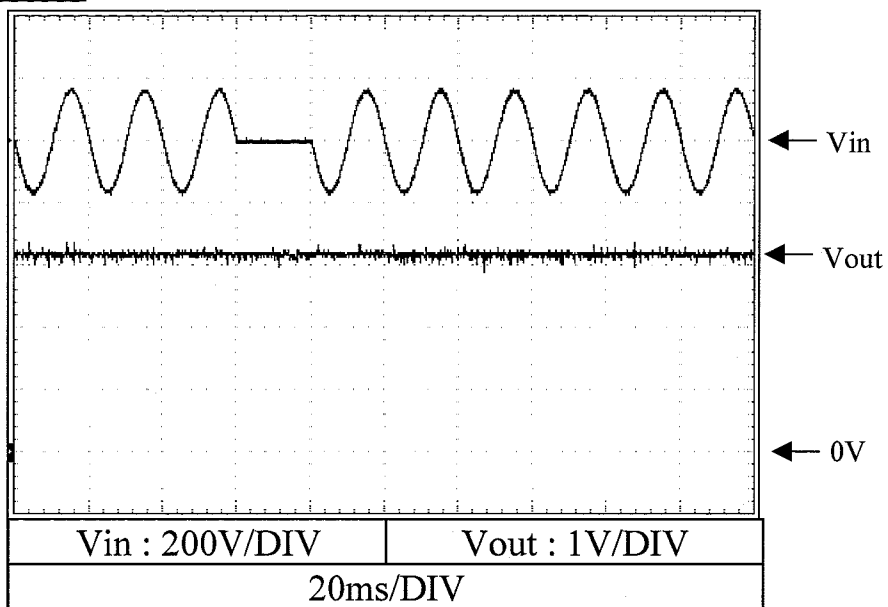

Time: 21ms

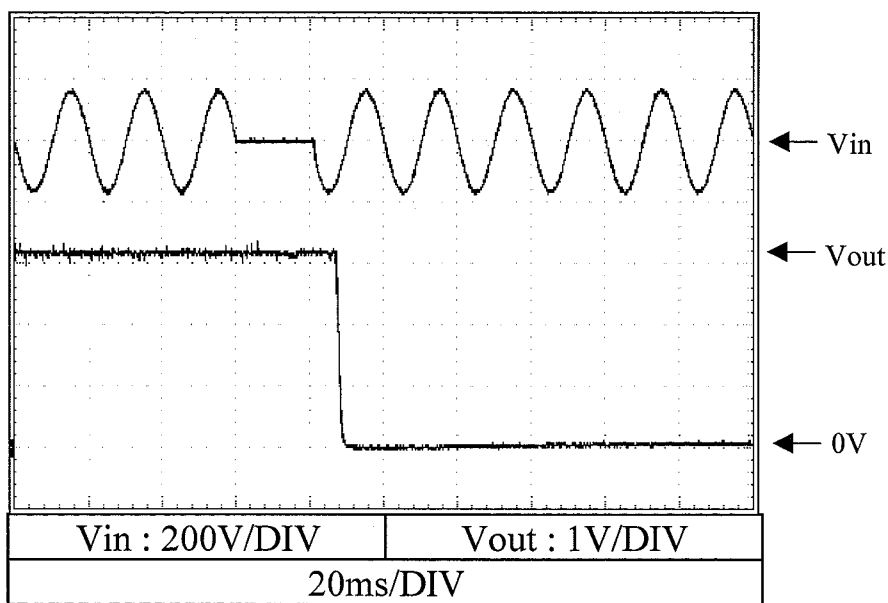

2.12 入力電圧瞬停特性
Momentary line voltage drop characteristics

Conditions Ta : 25°C
Iout : 100%(FL1)
Vin : 115V⇔0VAC
Time: 20ms

+5V

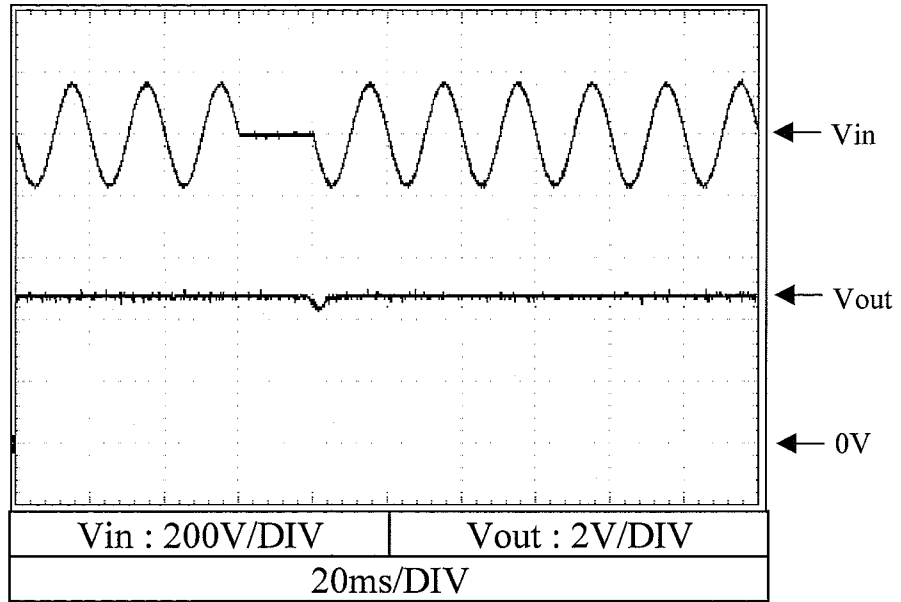

Time: 21ms

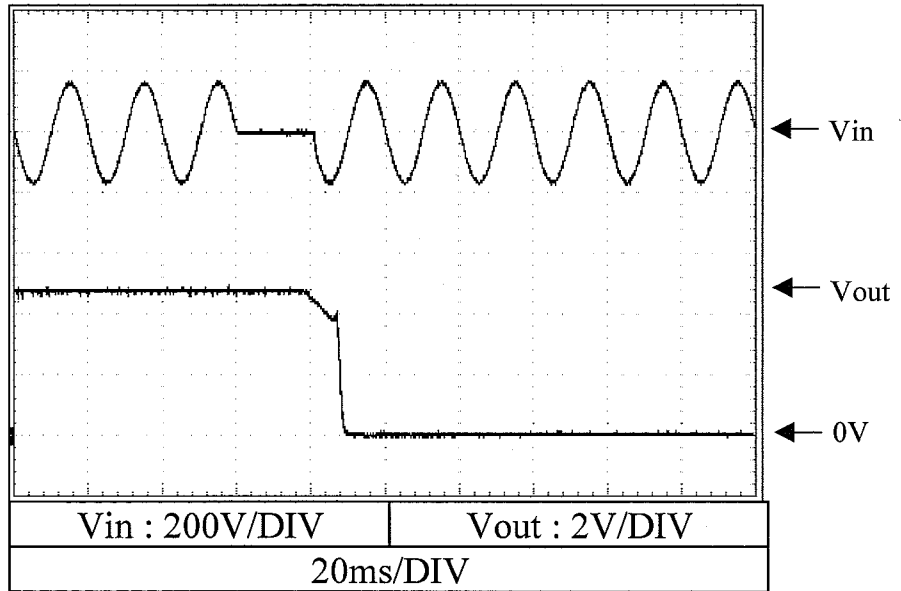

2.12 入力電圧瞬停特性
Momentary line voltage drop characteristics

Conditions Ta : 25°C
Iout : 100%(FL1)
Vin : 115V⇔0VAC
Time: 20ms

+12V

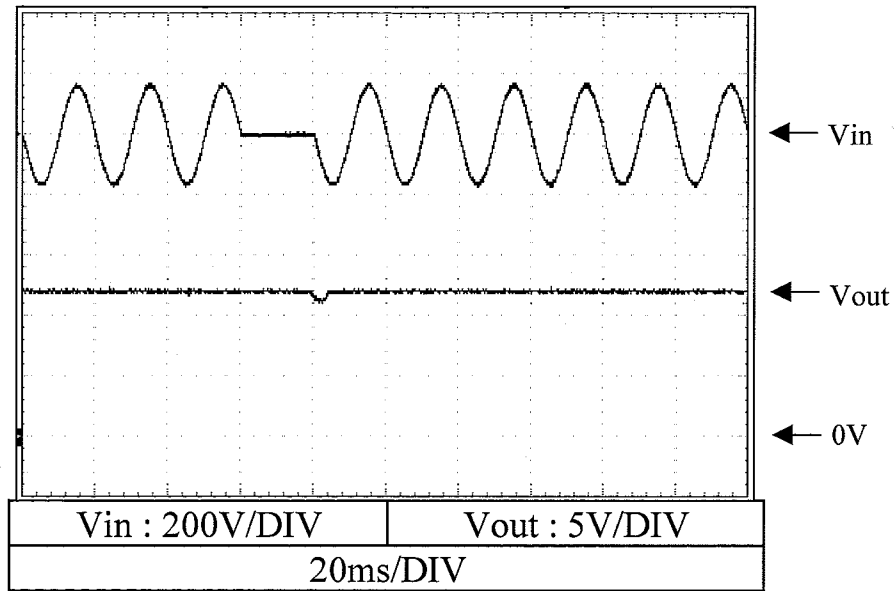

Time: 21ms

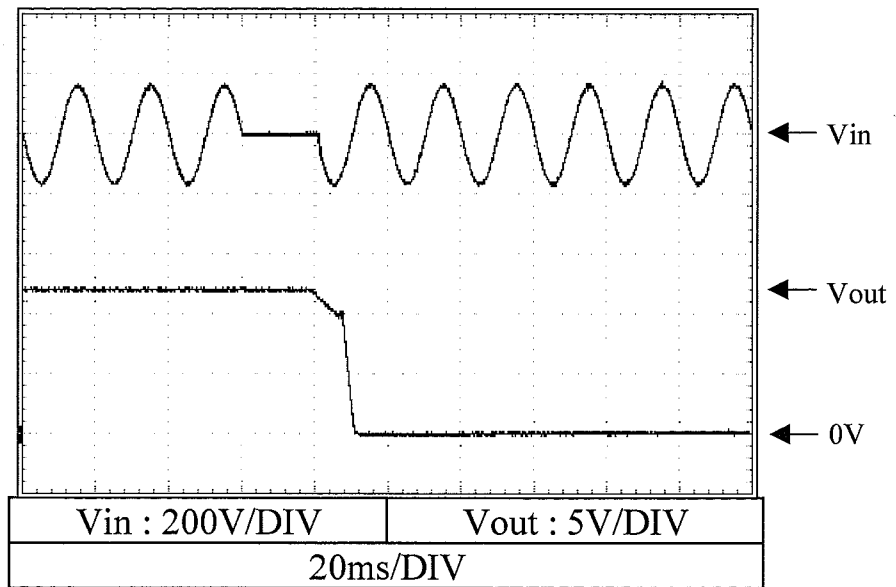

2.12 入力電圧瞬停特性
Momentary line voltage drop characteristics

Conditions Ta : 25°C
Iout : 100%(FL1)
Vin : 115V⇔0VAC
Time: 20ms

-12V

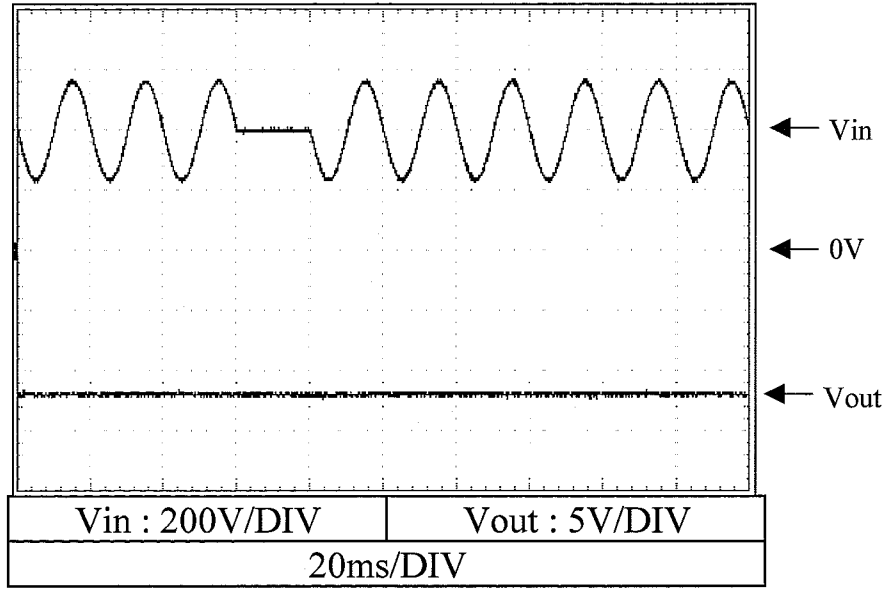

Time: 21ms

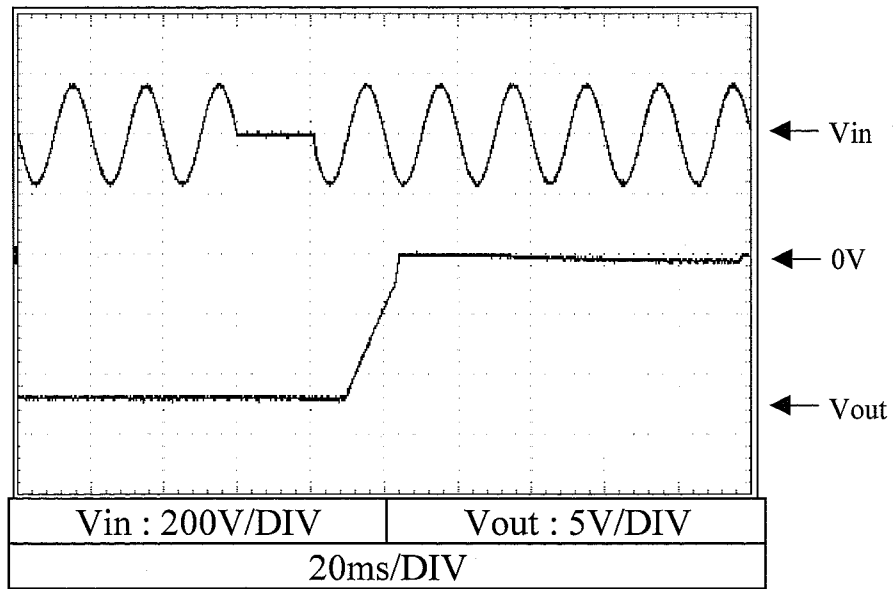

2.12 入力電圧瞬停特性
Momentary line voltage drop characteristics

Conditions Ta : 25°C
Iout : 100%(FL1)
Vin : 115V⇔0VAC
Time: 237ms

+5VSB

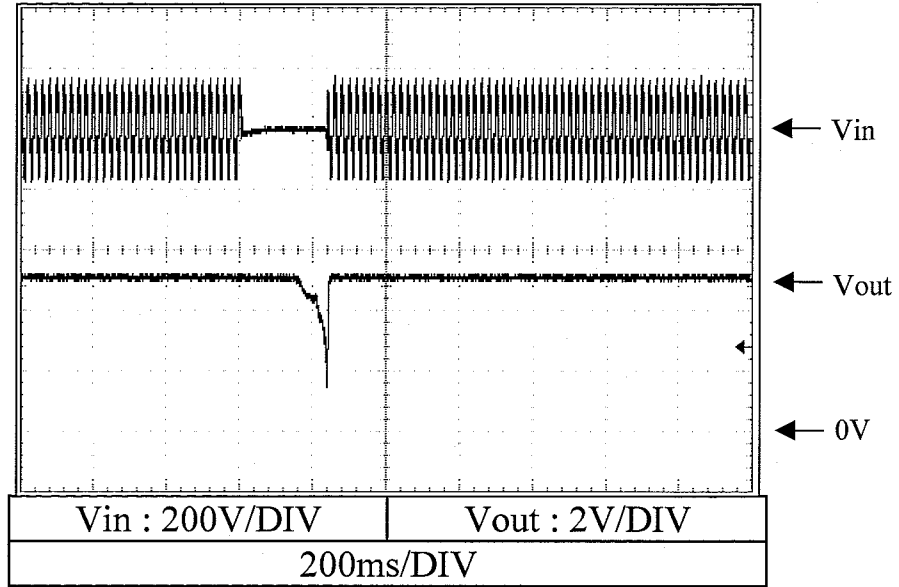

Time: 238ms

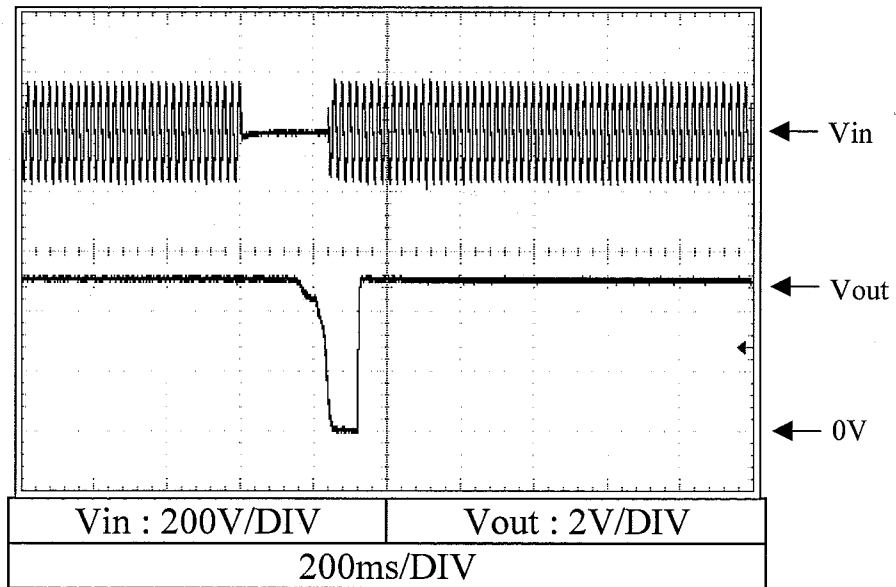

2.12 入力電圧瞬停特性
Momentary line voltage drop characteristics

Conditions Ta : 25°C
Iout : 100%
Vin : 115V⇔0VAC
Time: 227ms

+5VSB(Standby)

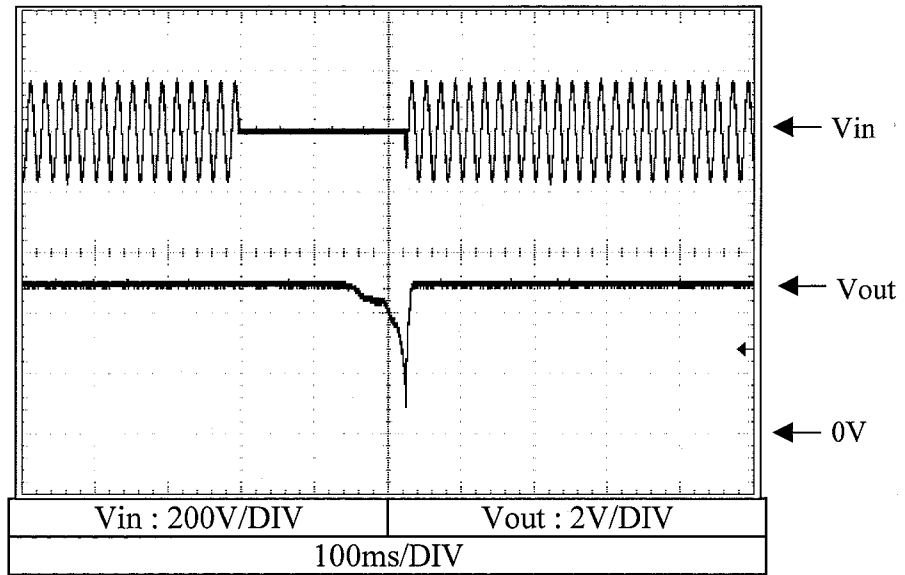

Time: 228ms

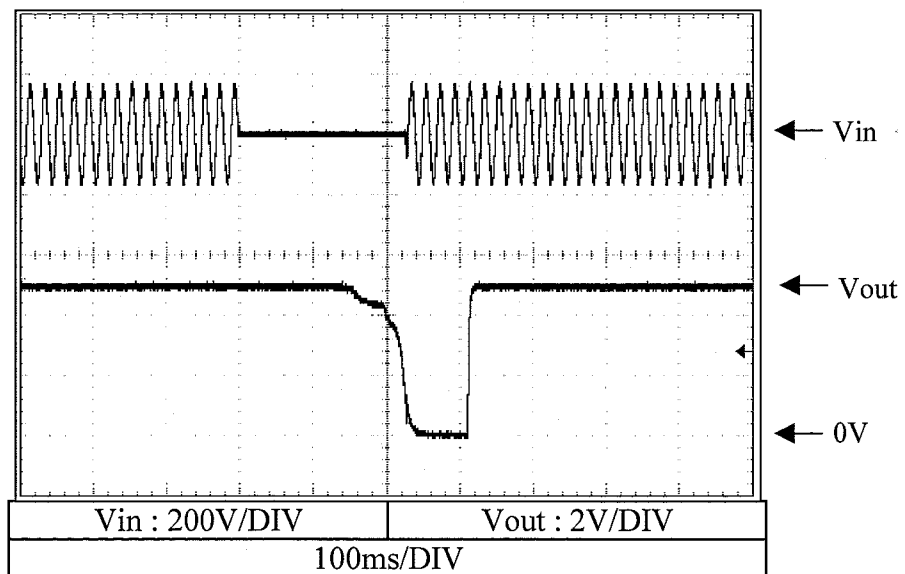

2.13 入力サージ電流 (突入電流) 特性
Inrush current characteristic

Conditions Vin : 100VAC
Iout : 100%
Ta : 25°C

Switch on phase angle
of input AC voltage
 $\phi = 0^\circ$

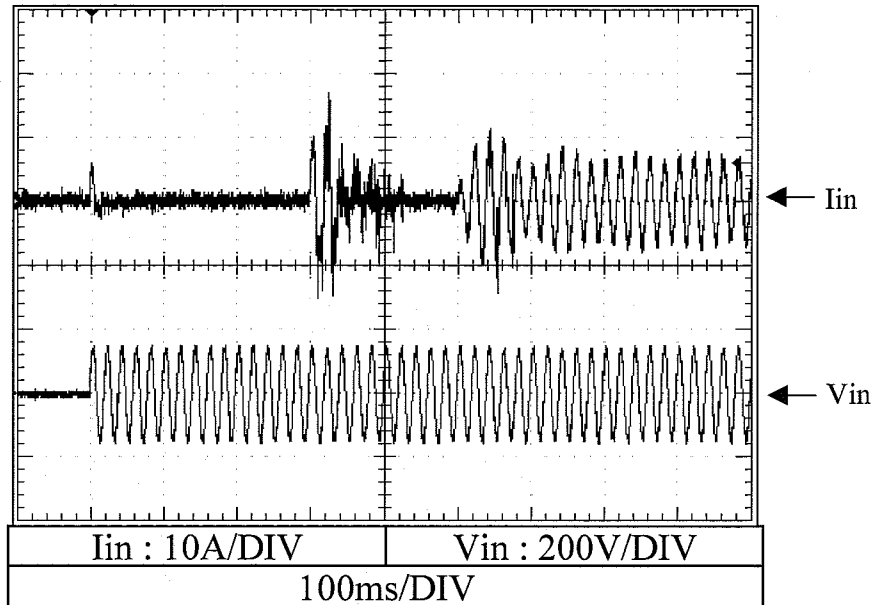

Switch on phase angle
of input AC voltage
 $\phi = 90^\circ$

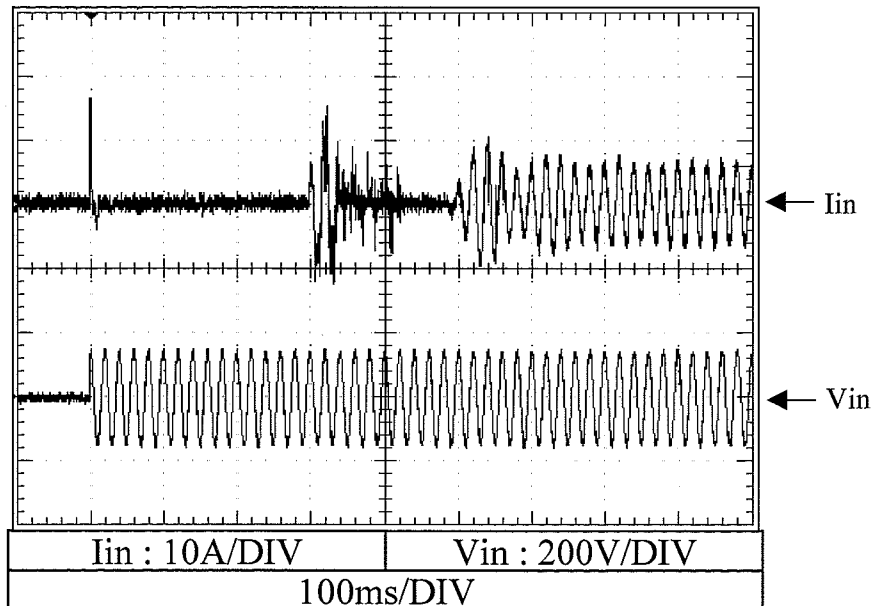

2.13 入力サージ電流 (突入電流) 特性
Inrush current characteristic

Conditions Vin : 200VAC
Iout : 100%
Ta : 25°C

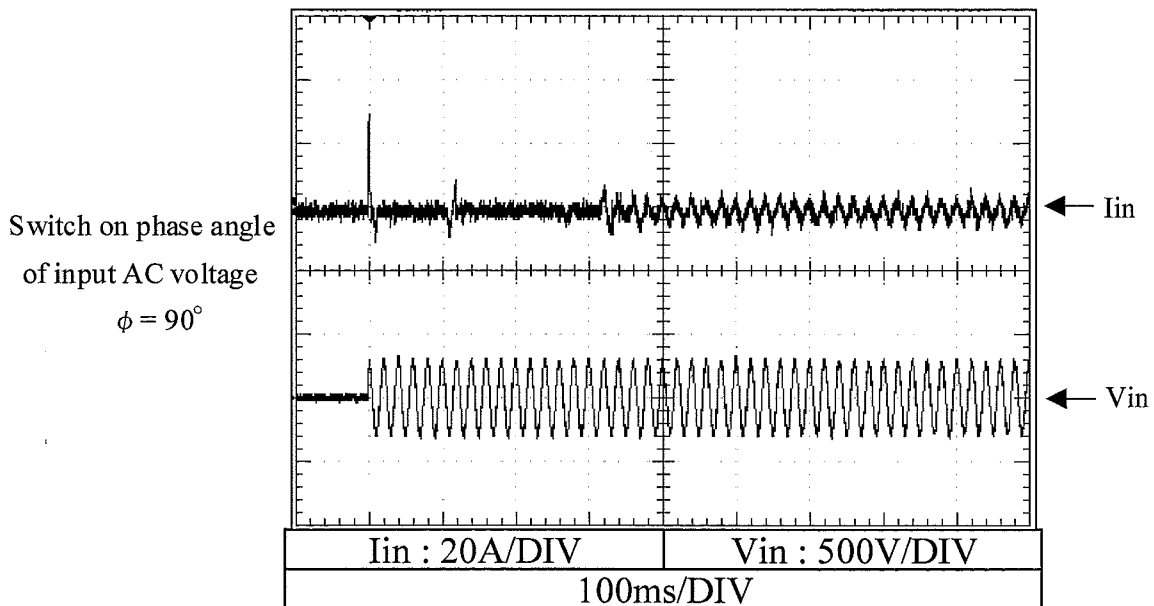
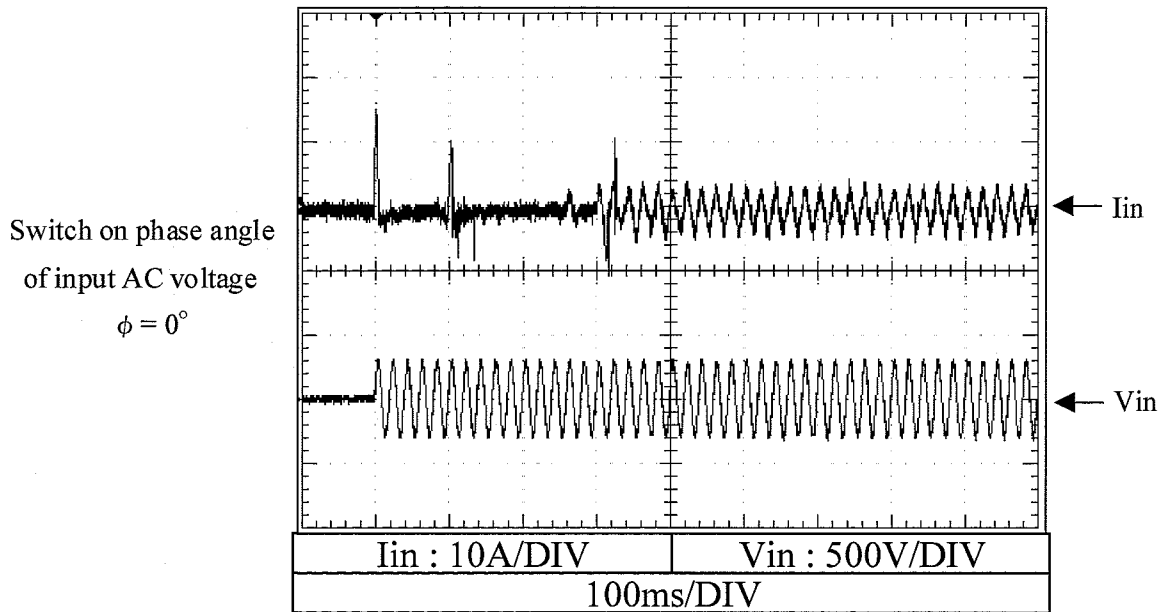

2.14 瞬停時突入電流特性
Inrush current characteristics

Conditions Iout : 100% ———
 : 50% - - - -
Ta : 25°C

Vin : 100VAC

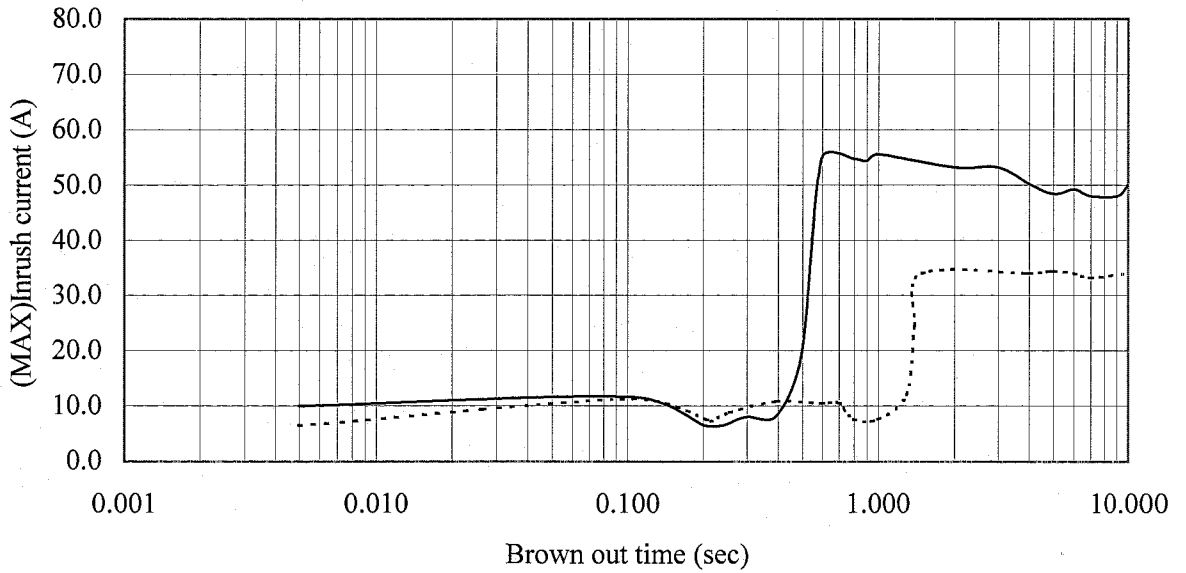

Vin : 200VAC

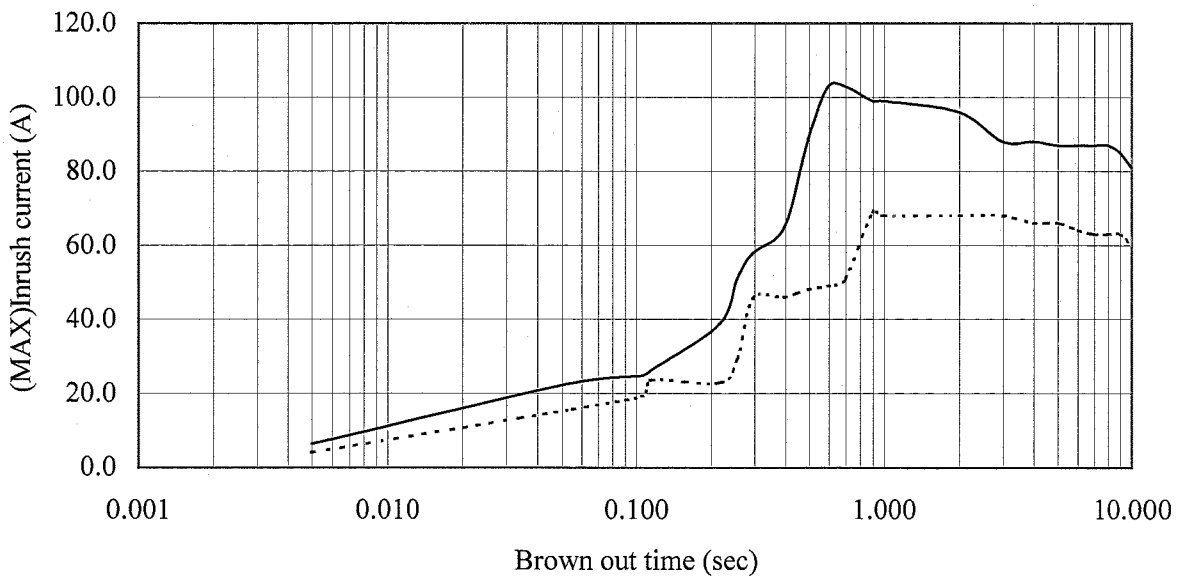

2.15 入力電流波形
Input current waveform

Conditions Vin : 100VAC
Iout : 100%(FL1)
Ta : 25°C

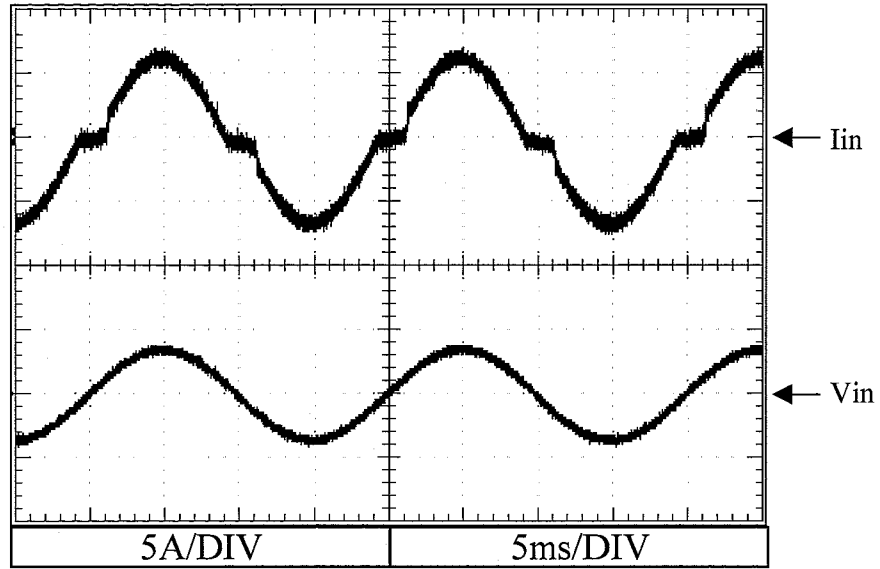

Conditions Vin : 240VAC
Iout : 100%(FL1)
Ta : 25°C

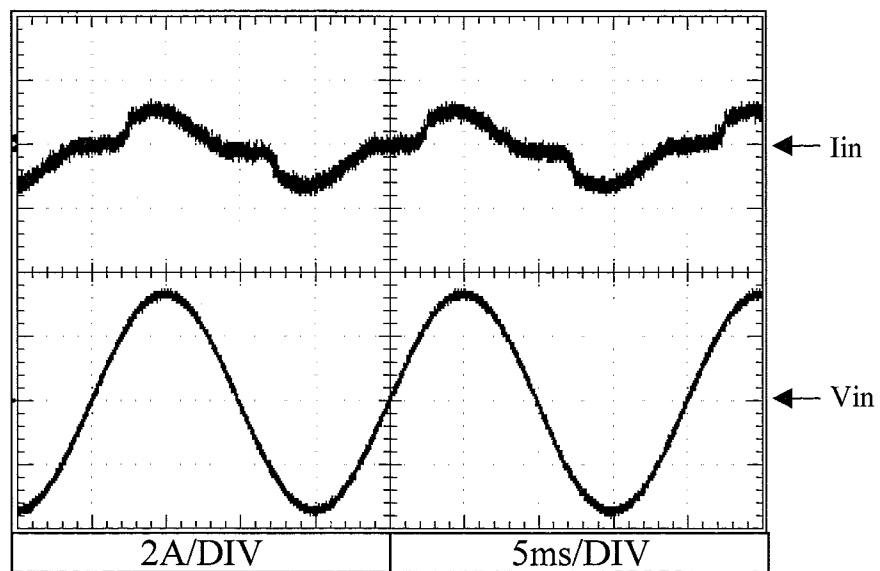

2.16 高調波成分
Input current harmonics

Conditions Vin : 100VAC
Iout : 100% (FL1)
Ta : 25°C

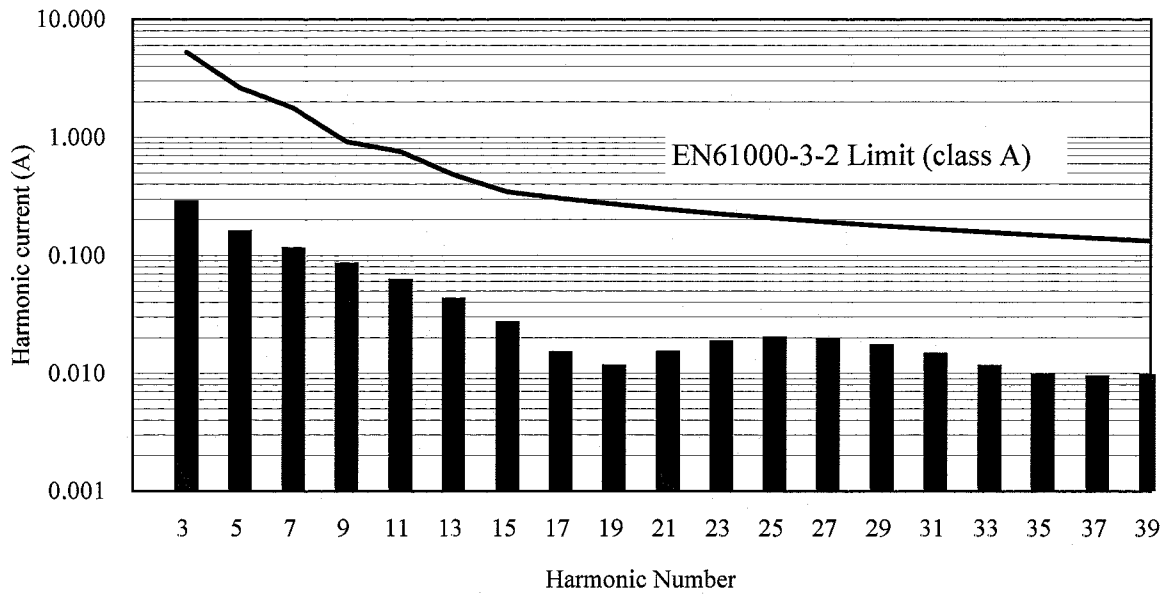

Conditions Vin : 230VAC
Iout : 100%
Ta : 25°C

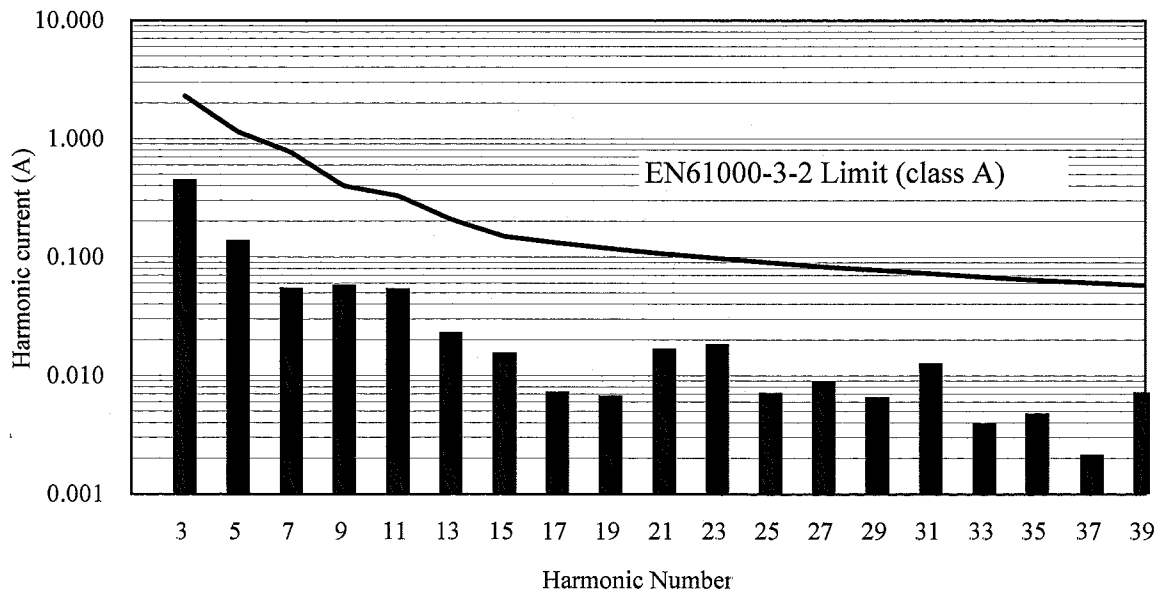

2.17 リーク電流特性

Leakage current characteristics

Conditions Iout : 0% -----
 : 100% —————
 Ta : 25°C
 f : 50/60Hz

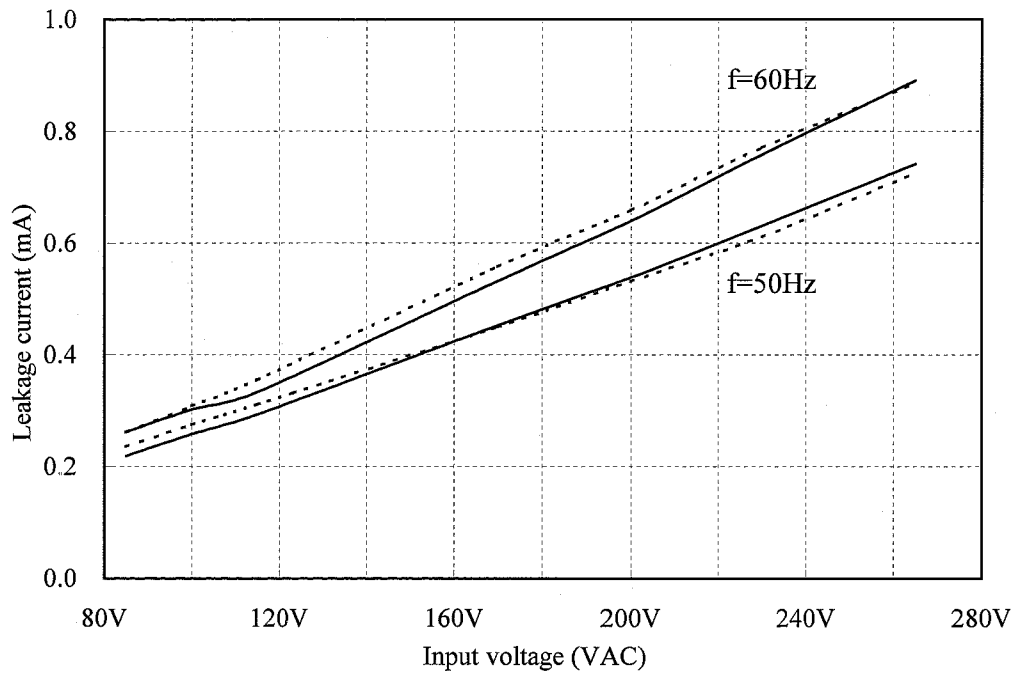

2.18 出力リップル、ノイズ波形
Output ripple and noise waveform
NORMAL MODE

Conditions Vin : 100VAC
Iout : FL1
Ta : 25°C

+3.3V

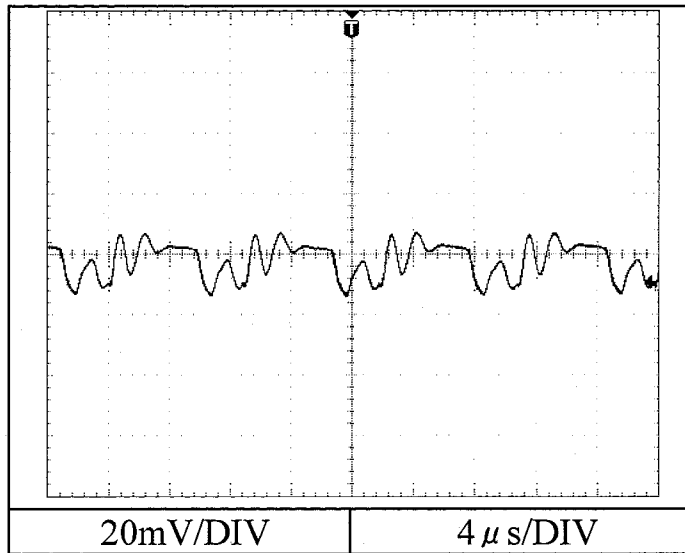

+5V

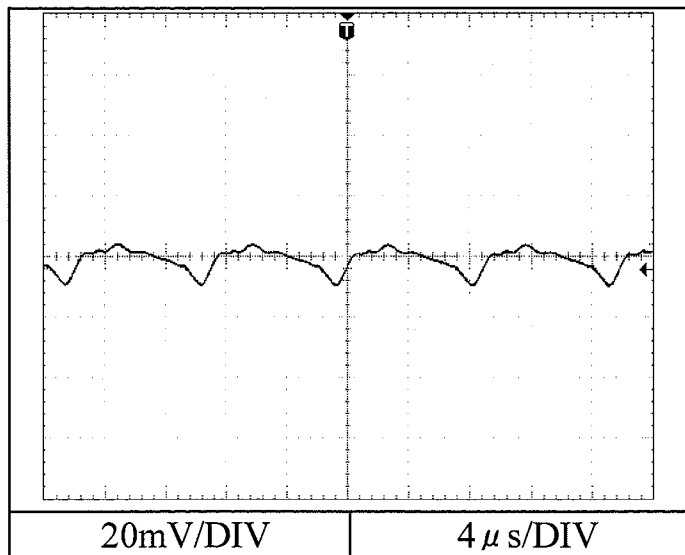

+12V

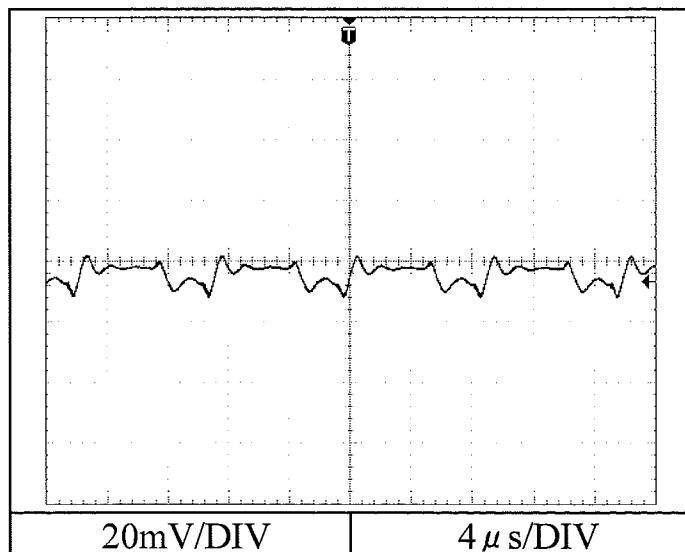

2.18 出力リップル、ノイズ波形
Output ripple and noise waveform
NORMAL MODE

Conditions V_{in} : 100VAC
 I_{out} : FL1
 T_a : 25°C

-12V

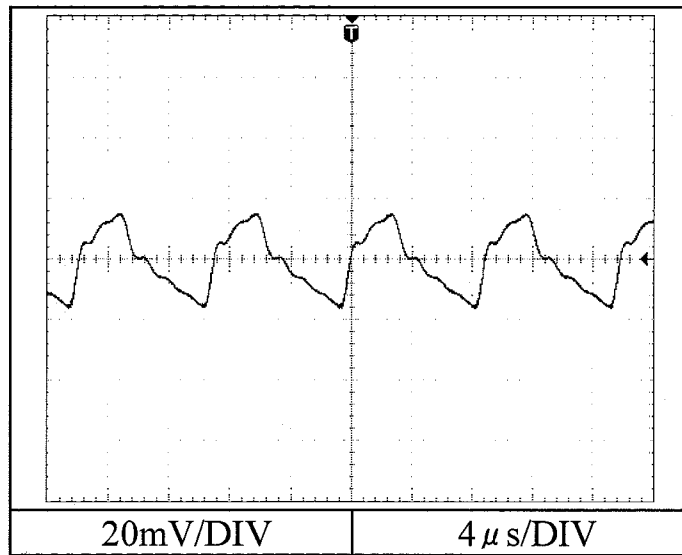

+5VSB

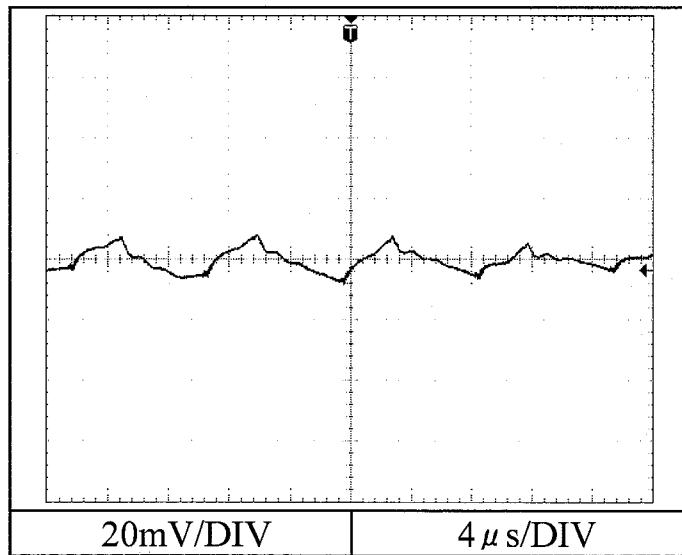

2.18 出力リップル、ノイズ波形
 Output ripple and noise waveform
 NORMAL MODE

Conditions V_{in} : 100VAC
 I_{out} : FL2
 T_a : 25°C

+3.3V

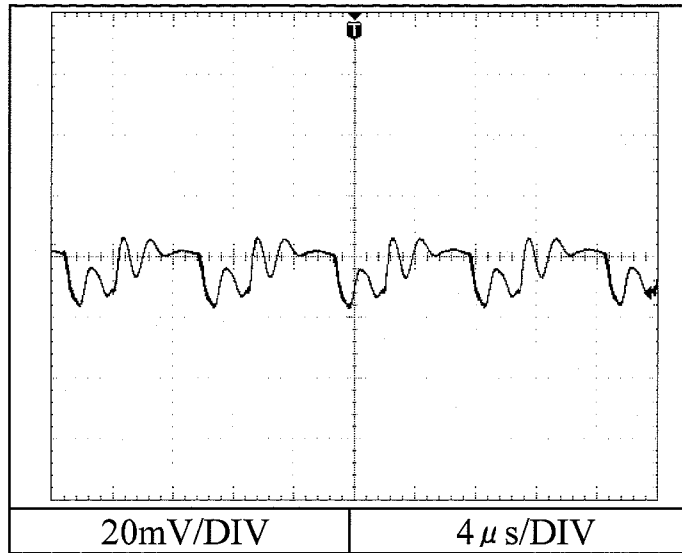

← Vout

+5V

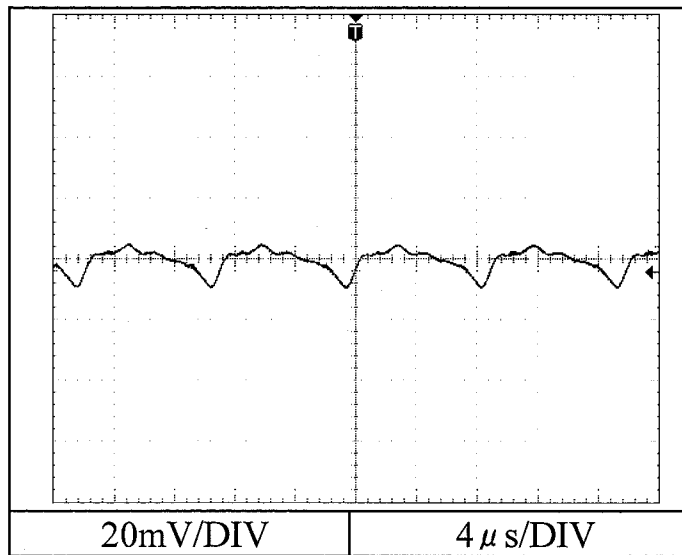

← Vout

+12V

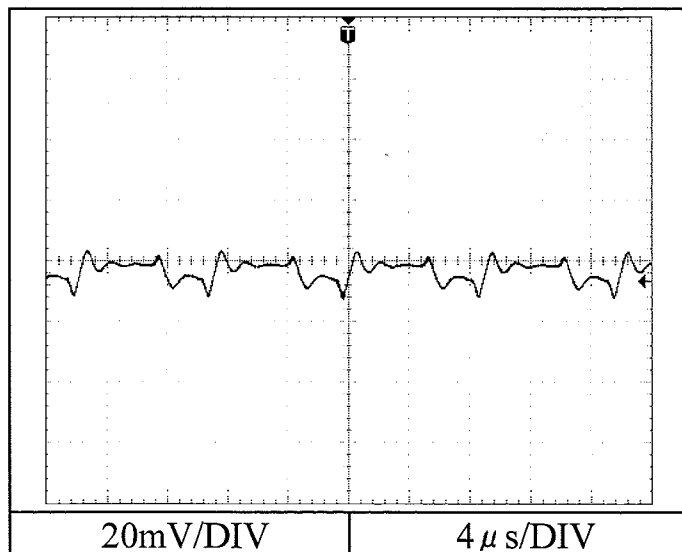

← Vout

2.18 出力リップル、ノイズ波形
Output ripple and noise waveform
NORMAL MODE

Conditions V_{in} : 100VAC
 I_{out} : FL2
 T_a : 25°C

-12V

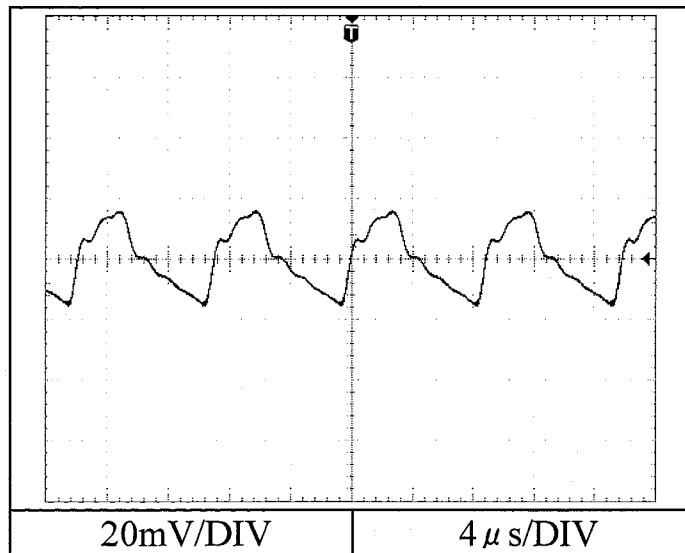

+5VSB

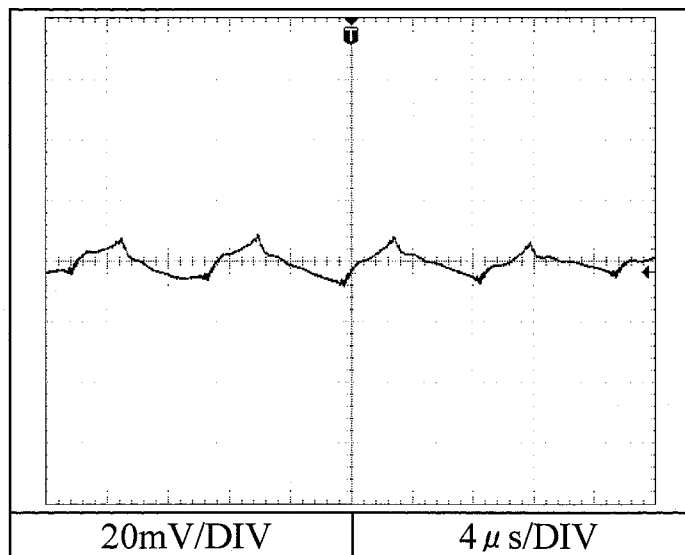

2.18 出力リップル、ノイズ波形
 Output ripple and noise waveform
 NORMAL MODE

Conditions Vin : 100VAC
 Iout : FL3
 Ta : 25°C

+3.3V

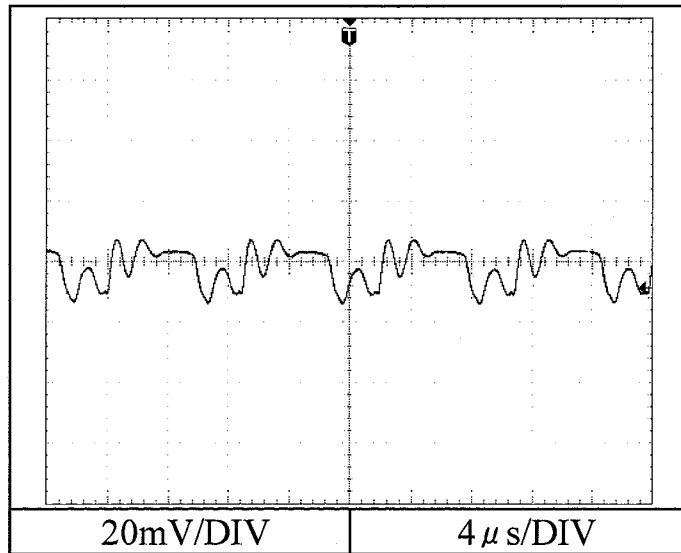

← Vout

+5V

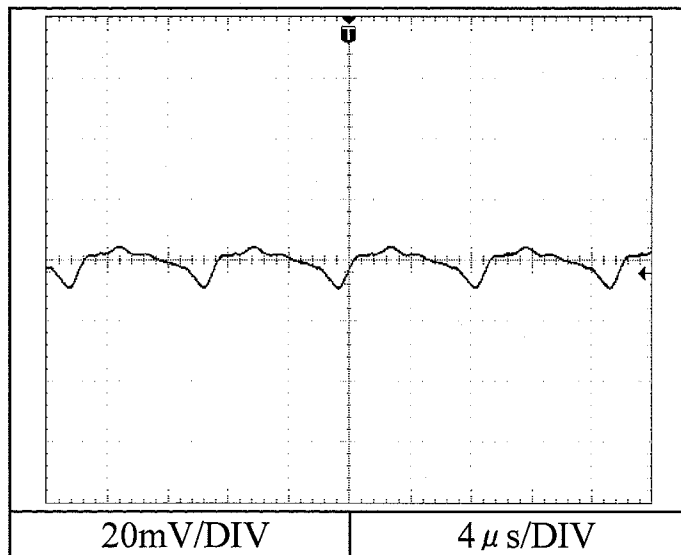

← Vout

+12V

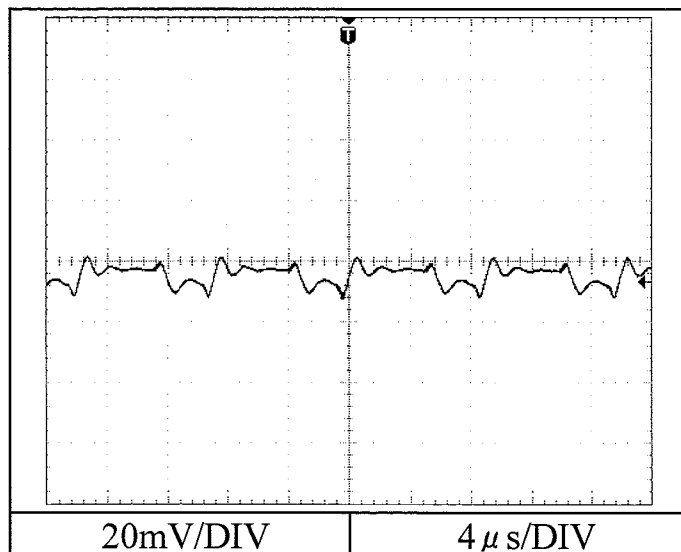

← Vout

2.18 出力リップル、ノイズ波形
Output ripple and noise waveform
NORMAL MODE

Conditions Vin : 100VAC
Iout : FL3
Ta : 25°C

-12V

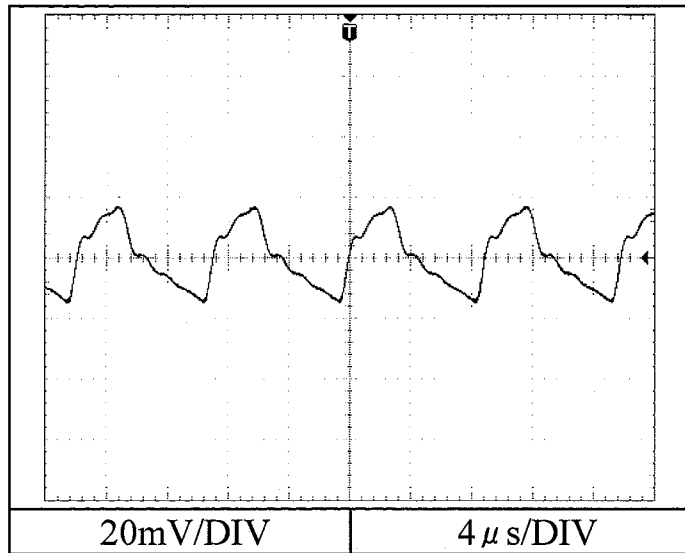

+5VSB

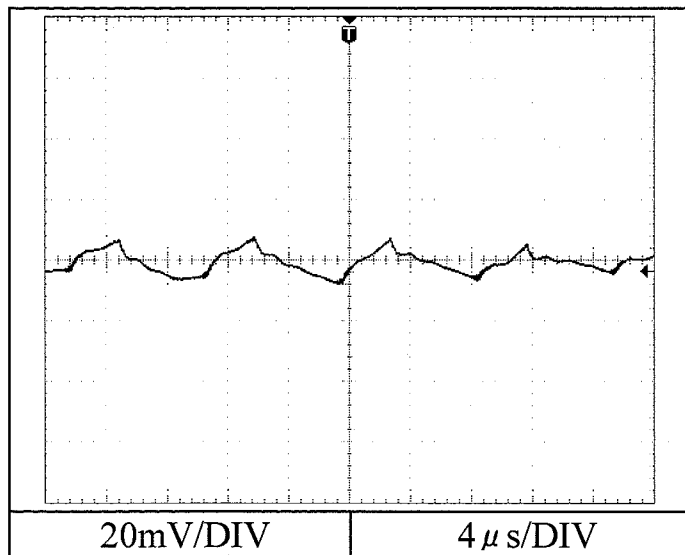

2.18 出力リップル、ノイズ波形
Output ripple and noise waveform
NORMAL MODE

Conditions Vin : 100VAC
Iout : SB
Ta : 25°C

+5VSB (Standby)

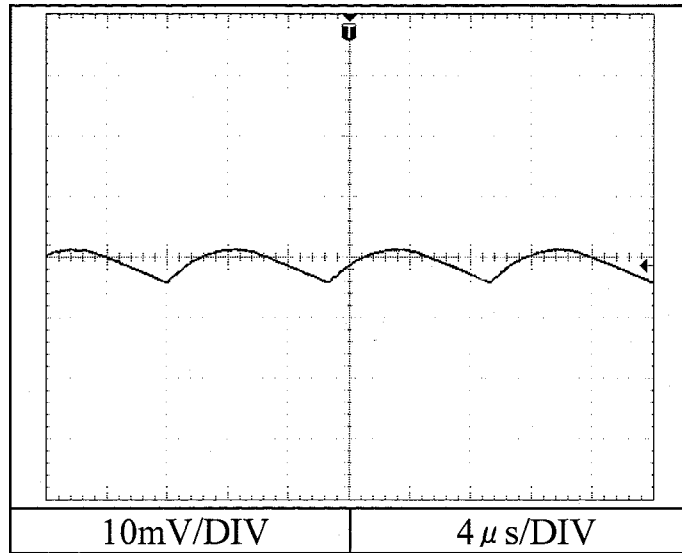

2.18 出力リップル、ノイズ波形

Output ripple and noise waveform

NORMAL + COMMON MODE

Conditions V_{in} : 100VAC

I_{out} : FL1

T_a : 25°C

+3.3V

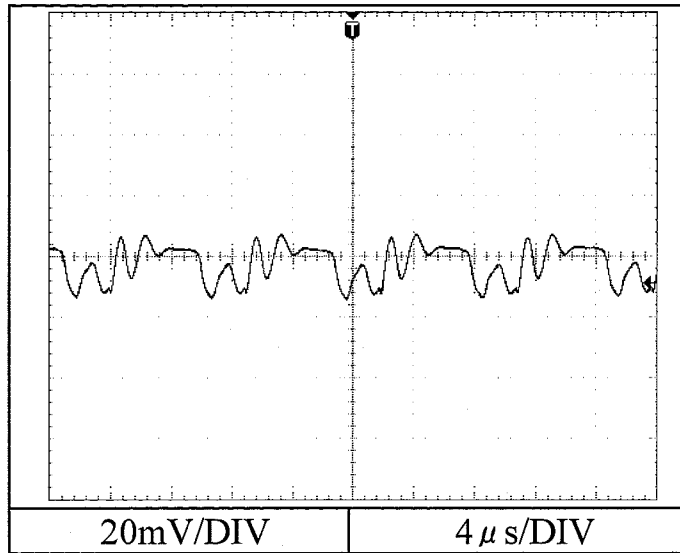

+5V

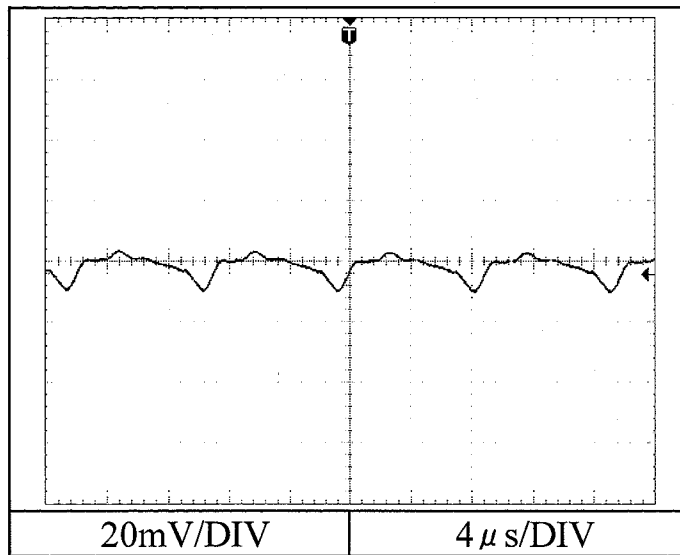

+12V

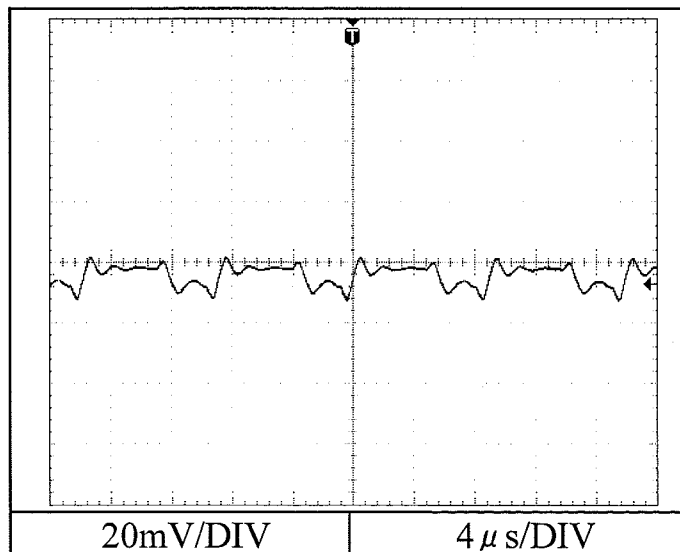

2.18 出力リップル、ノイズ波形
Output ripple and noise waveform

Conditions V_{in} : 100VAC
 I_{out} : FL1
 T_a : 25°C

NORMAL + COMMON MODE

-12V

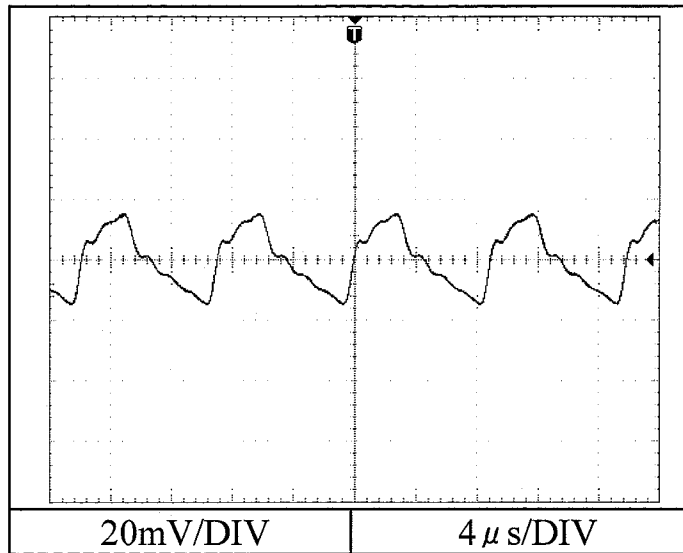

+5VSB

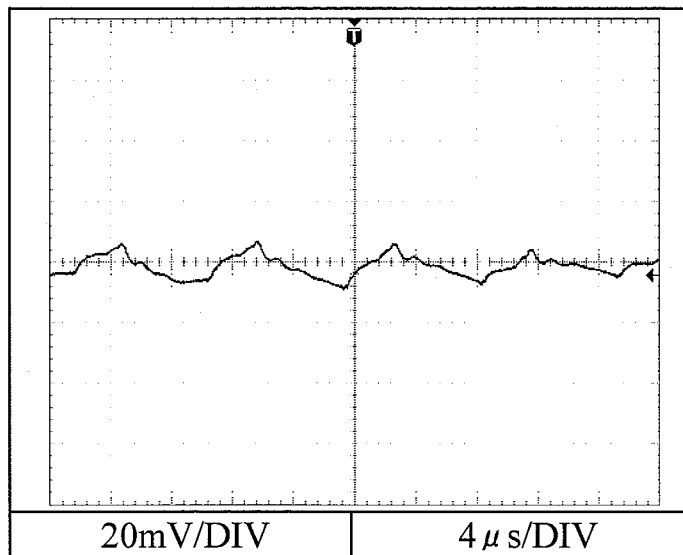

2.18 出力リップル、ノイズ波形
Output ripple and noise waveform

Conditions V_{in} : 100VAC
 I_{out} : FL2
 T_a : 25°C

NORMAL + COMMON MODE

+3.3V

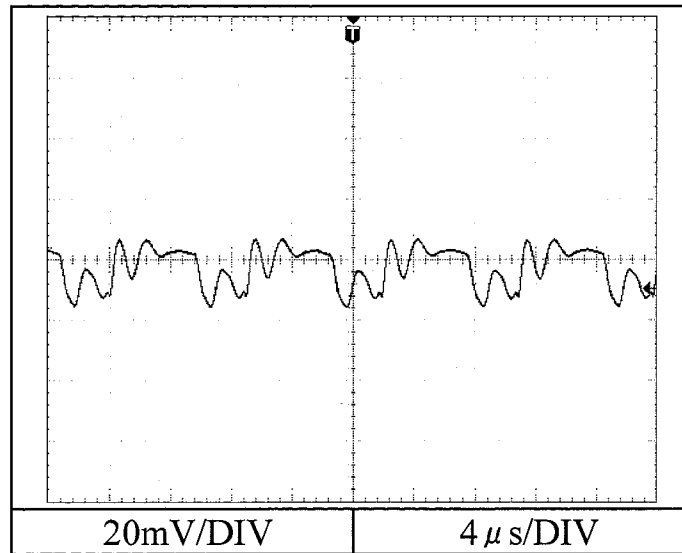

+5V

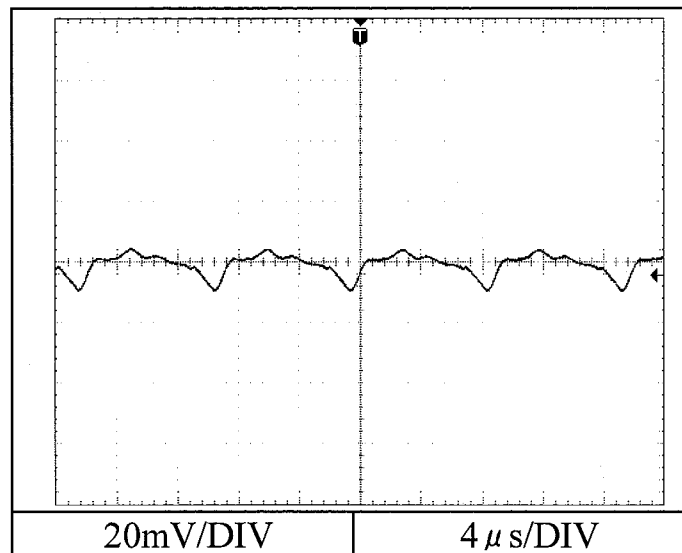

+12V

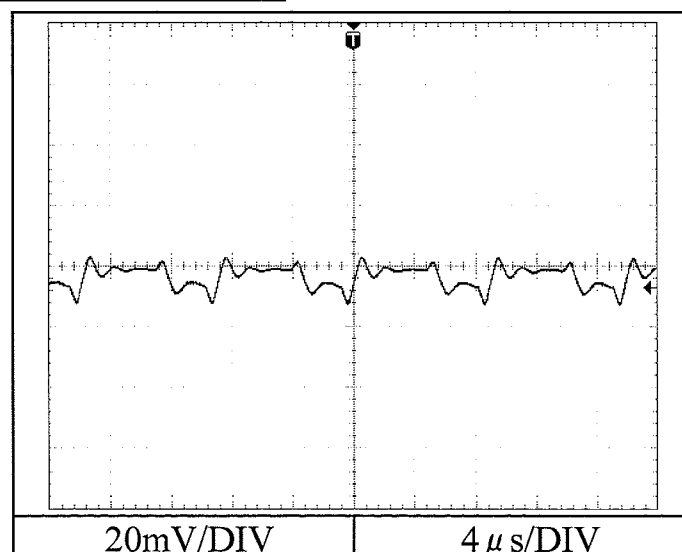

2.18 出力リップル、ノイズ波形
Output ripple and noise waveform

Conditions Vin : 100VAC
Iout : FL2
Ta : 25°C

NORMAL + COMMON MODE

-12V

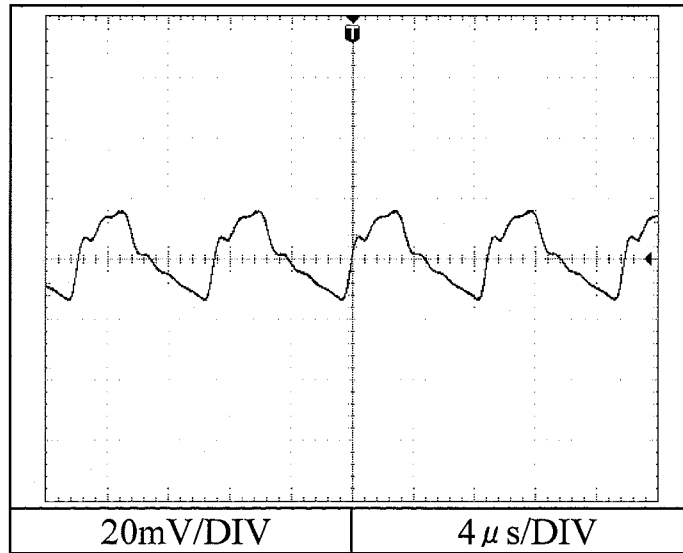

← Vout

+5VSB

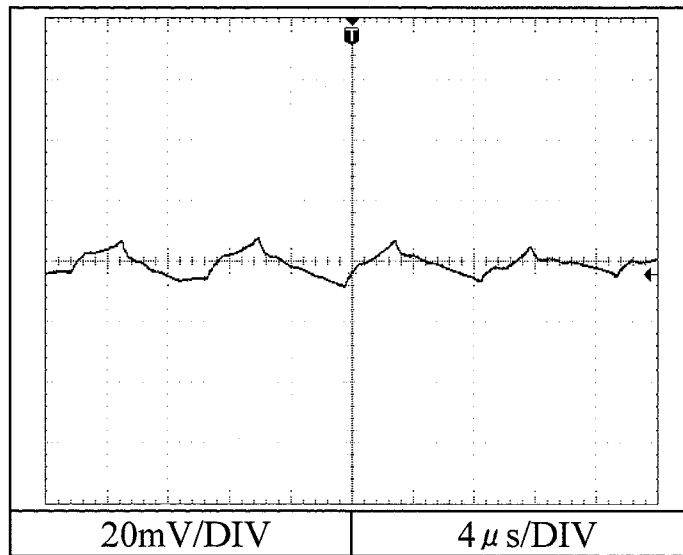

← Vout

2.18 出力リップル、ノイズ波形
Output ripple and noise waveform

Conditions Vin : 100VAC
Iout : FL3
Ta : 25°C

NORMAL + COMMON MODE

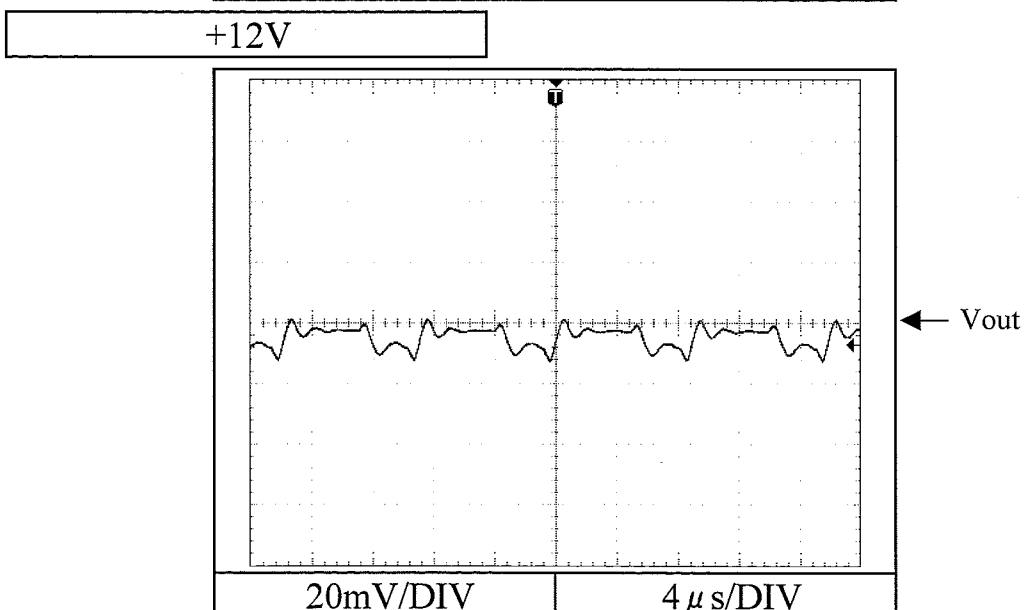
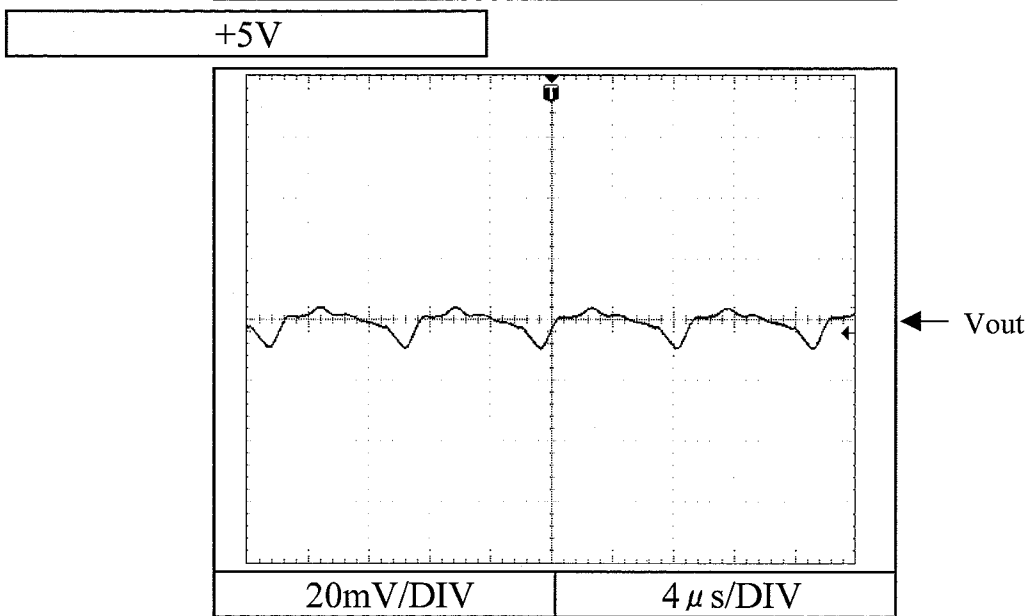
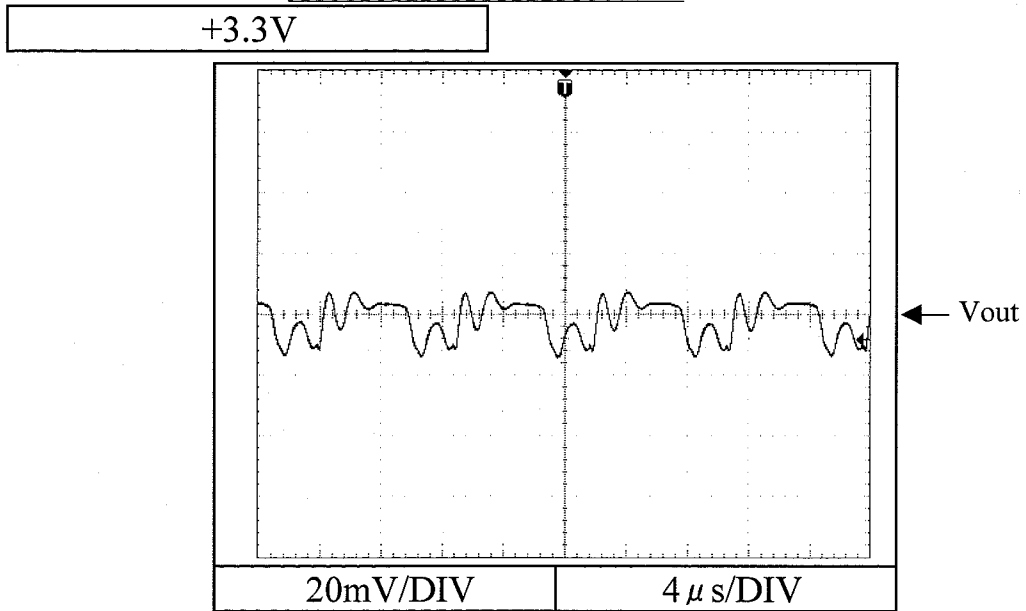

2.18 出力リップル、ノイズ波形
Output ripple and noise waveform

Conditions V_{in} : 100VAC
 I_{out} : FL3
 T_a : 25°C

NORMAL + COMMON MODE

-12V

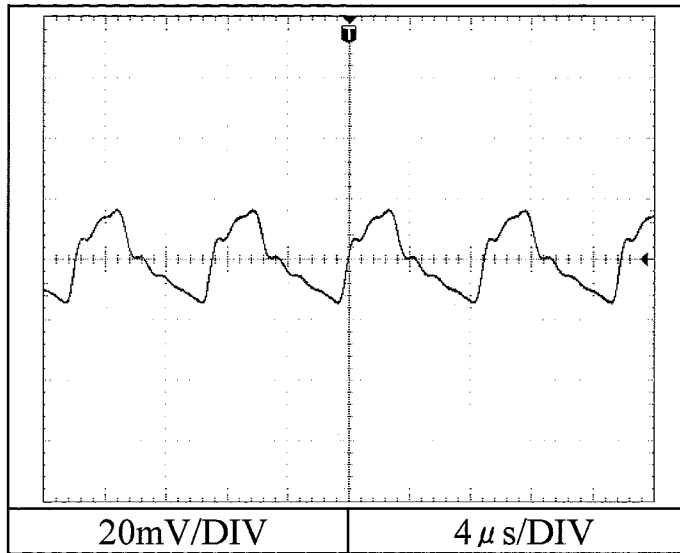

+5VSB

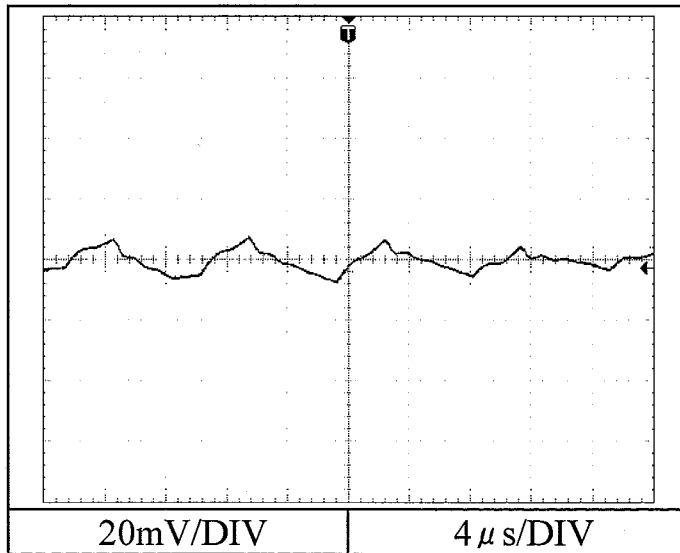

2.18 出力リップル、ノイズ波形
Output ripple and noise waveform

Conditions Vin : 100VAC
Iout : SB
Ta : 25°C

NORMAL + COMMON MODE

+5VSB (Standby)

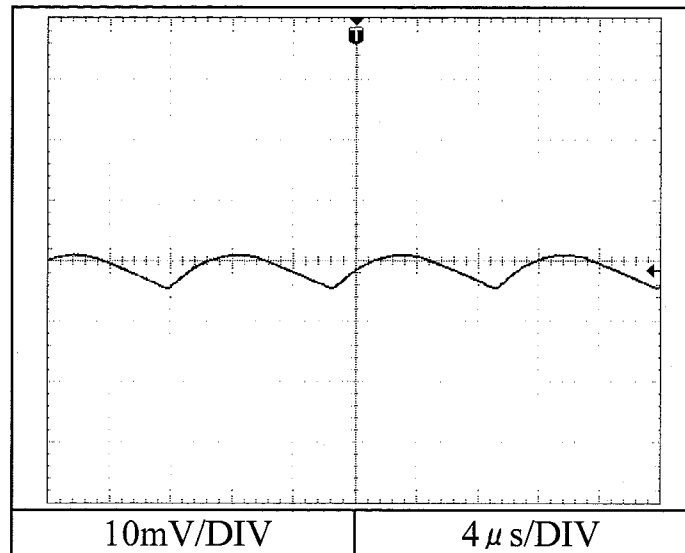

2.19 EMI 特性
Electro-Magnetic Interference characteristics

Conditions Vin : 100VAC
Iout : FL1

雑音端子電圧
Conducted Emission

Phase: L

Ref	Point A (0.562 MHz)	
	Limit (dB μ V)	Measure (dB μ V)
QP	56.0	37.0
AV	46.0	36.5

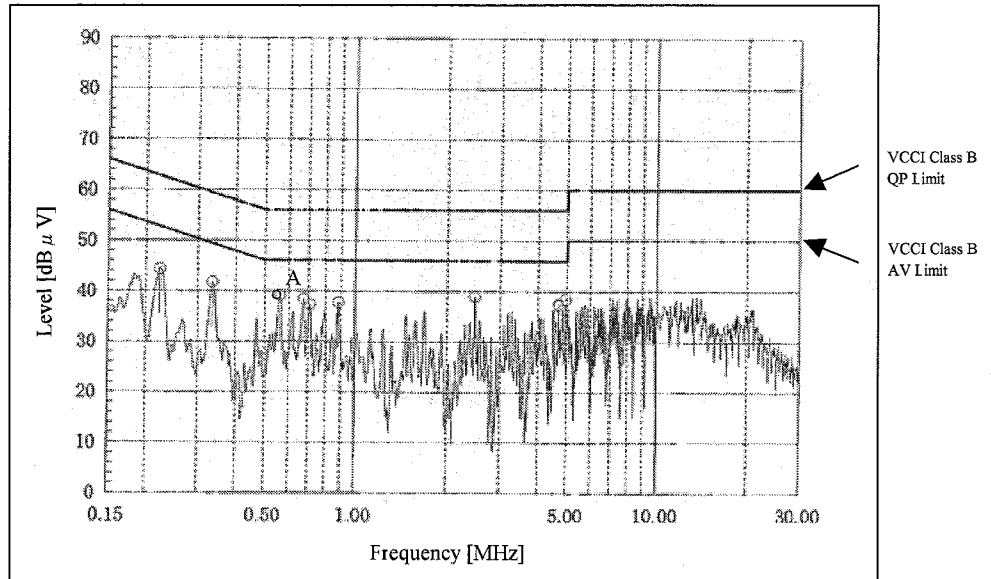

Phase: N

Ref	Point B (0.225 MHz)	
	Limit (dB μ V)	Measure (dB μ V)
QP	62.6	45.0
AV	52.6	45.0

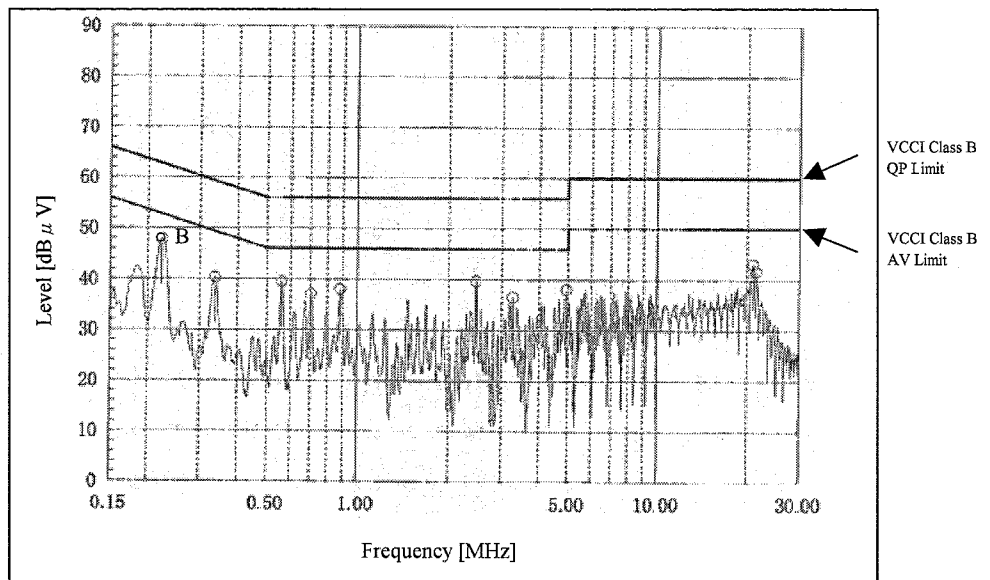

EN55022-Bの限度値はVCCI class Bの限度値と同じ
Limits of EN55022-B is same as its VCCI class B.

2.19 EMI 特性
Electro-Magnetic Interference characteristics

Conditions Vin : 230VAC
Iout : FL1

雑音端子電圧
Conducted Emission

Phase: L

Ref Data	Point A (0.224MHz)	
	Limit (dB μ V)	Measure (dB μ V)
QP	62.7	43.0
AV	52.7	43.0

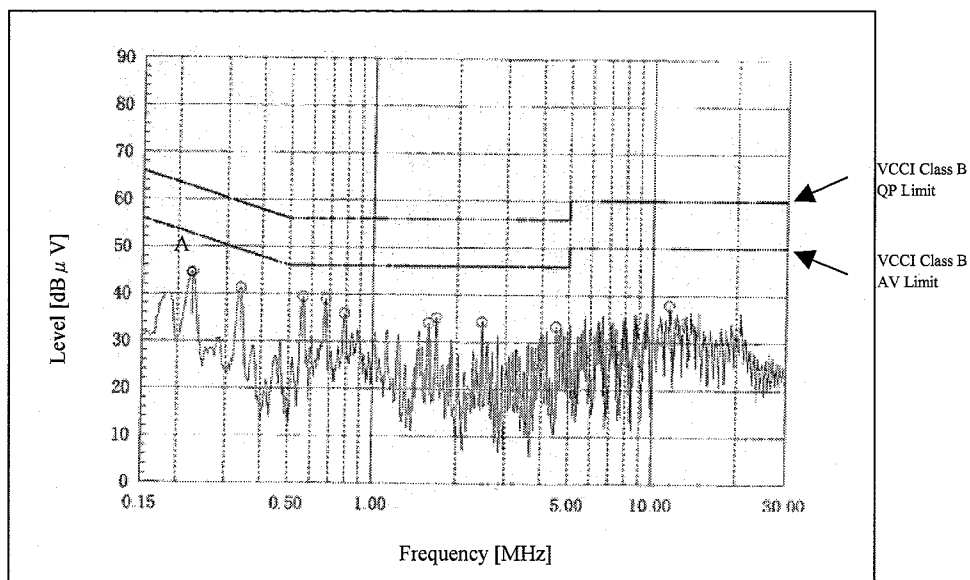

Phase: N

Ref Data	Point B (0.223MHz)	
	Limit (dB μ V)	Measure (dB μ V)
QP	62.7	46.0
AV	52.7	46.0

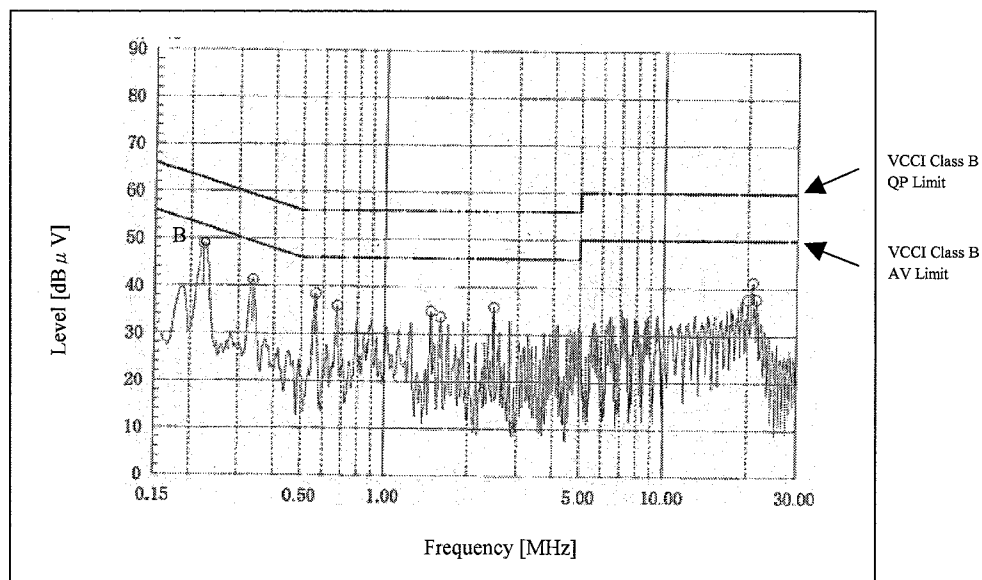

EN55022-Bの限度値はVCCI class Bの限度値と同じ
Limits of EN55022-B is same as its VCCI class B.

2.19 EMI 特性

Electro-Magnetic Interference characteristics

Conditions Vin : 100VAC

ConditionsIout : FL1

雑音電界強度

Radiated Emission

VERTICAL	
Point A (59.99 MHz)	
Limit (dBuV)	Measure (dBuV)
30.0	25.6

HORIZONTAL	
Point B (159.85MHz)	
Limit (dBuV)	Measure (dBuV)
30.0	23.0

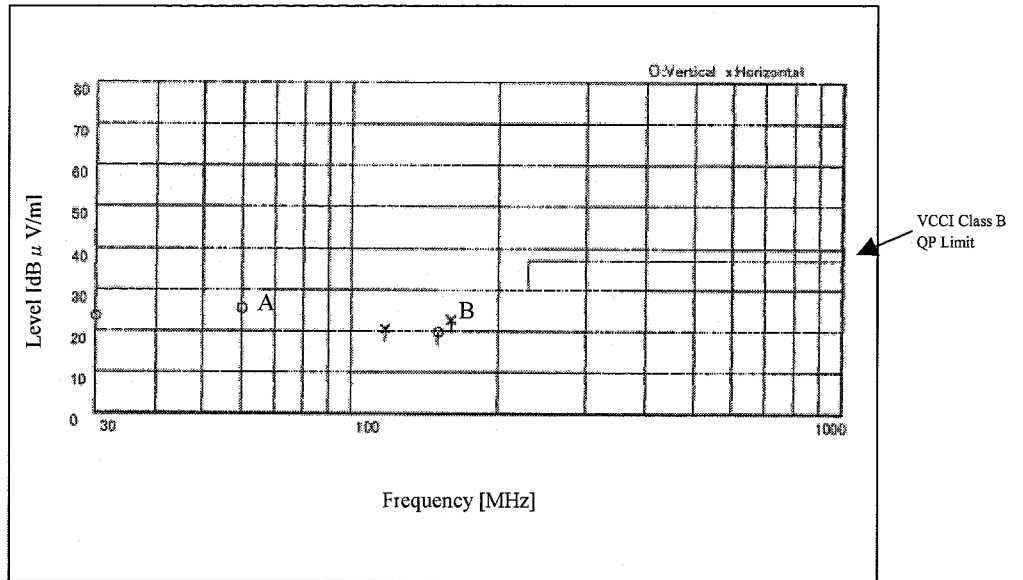

Conditions Vin : 230VAC

ConditionsIout : 100%

VERTICAL	
Point C (59.99 MHz)	
Limit (dBuV)	Measure (dBuV)
30.0	25.1

HORIZONTAL	
Point D (159.85MHz)	
Limit (dBuV)	Measure (dBuV)
30.0	21.5

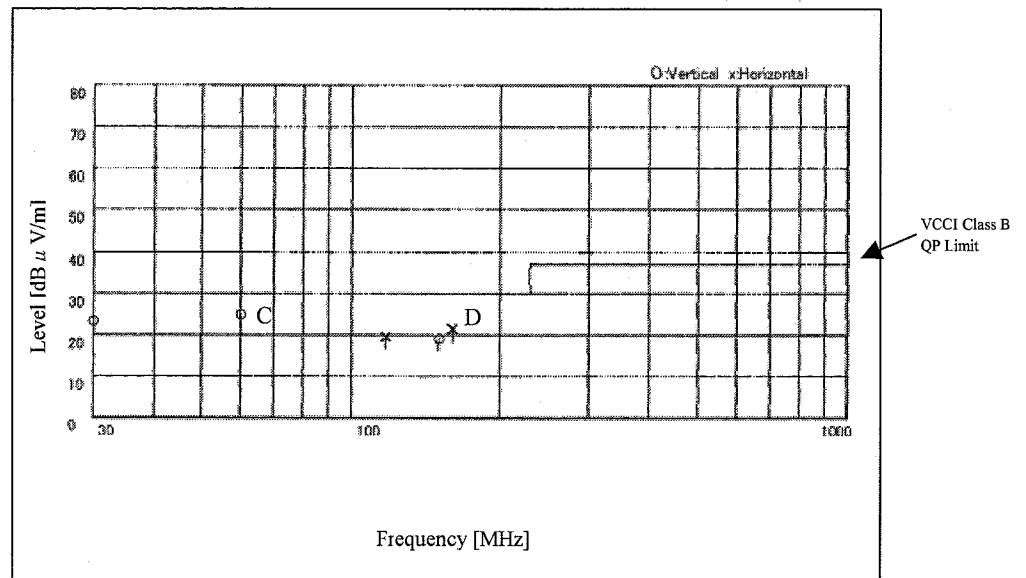

EN55022-Bの限度値はVCCI class Bの限度値と同じ

Limits of EN55022-B is same as its VCCI class B.