

VS75P

EVALUATION DATA

型式データ

DWG No. A220-53-01		
APPD	CHK	DWG
M. Iga	Katamoto	K. Shimamura
27. May. '04	26/MAY/04	26/May/04

INDEX

1. 測定方法	Evaluation Method	PAGE
1.1	測定回路 Circuit used for determination	T-1~4
	(1) 静特性 Steady state data	
	(2) 通電ドリフト特性 Warm up voltage drift characteristics	
	(3) 過電圧保護特性 Over voltage protection (OVP) characteristics	
	(4) 出力立ち上がり特性 Output rise characteristics	
	(5) 出力立ち下がり特性 Output fall characteristics	
	(6) 過渡応答（入力急変）特性 Dynamic line response characteristics	
	(7) 出力保持時間特性 Hold up time characteristics	
	(8) 入力電圧瞬停特性 Response to brown out characteristics	
	(9) 過電流保護特性 Over current protection (OCP) characteristics	
	(10) 過渡応答（負荷急変）特性 Dynamic load response characteristics	
	(11) 入力サージ電流（突入電流）特性 Inrush current characteristics	
	(12) リーク電流特性 Leakage current characteristics	
	(13) 出力リップル、ノイズ特性 Output ripple and noise characteristics	
	(14) EMI特性 Electro-Magnetic Interference characteristics	
1.2	使用測定機器 List of equipment used	T-5
2.	特性データ Characteristics	
2.1	静特性 Steady state data	
	(1) 入力・負荷・温度変動	
	Regulation - line and load, temperature drift	T-6
	(2) 出力電圧・リップル電圧対入力電圧	
	Output voltage and ripple voltage vs. input voltage	T-6
	(3) 効率・入力電流対出力電流	
	Efficiency and input current vs. output current	T-7
	(4) 力率・入力電流対出力電流	
	Power factor and input current vs. output current	T-7
2.2	通電ドリフト特性 Warm up voltage drift characteristics	T-8
2.3	過電流保護特性 Over current protection (OCP) characteristics	T-9
2.4	過電圧保護特性 Over voltage protection (OVP) characteristics	T-10
2.5	出力立ち上がり特性 Output rise characteristics	T-11
2.6	出力立ち下がり特性 Output fall characteristics	T-12

2.7	出力保持時間特性	Hold up time characteristics	T-13
2.8	過渡応答 (入力急変) 特性	Dynamic line response characteristics	T-13
2.9	過渡応答 (負荷急変) 特性	Dynamic load response characteristics	T-14
2.10	入力電圧瞬停特性	Response to brown out characteristics	T-15
2.11	入力サージ電流 (突入電流) 特性	Inrush current waveform	T-16
2.12	瞬停時突入電流特性	Inrush current characteristics	T-17
2.13	入力電流波形	Input current waveform	T-17
2.14	高調波成分	Input current harmonics	T-18
2.15	リーク電流特性	Leakage current characteristics	T-19
2.16	出力リップル、ノイズ波形	Output ripple and noise waveform	T-20
2.17	EMI特性	Electro-Magnetic Interference characteristics	T-21~22

使用記号 Terminology used

	Definition
V_{in} 入力電圧 Input voltage
V_{out} 出力電圧 Output voltage
I_{in} 入力電流 Input current
I_{out} 平均出力電流 Average Output current
T_a 周囲温度 Ambient temperature

1. 測定方法 Evaluation Method

1.1 測定回路 Circuit used for determination

- (1) 静特性 Steady state data
- (2) 通電ドリフト特性 Warm up voltage drift characteristics
- (3) 過電圧保護特性 Over voltage protection (OVP) characteristics
- (4) 出力立ち上がり特性 Output rise characteristics
- (5) 出力立ち下がり特性 Output fall characteristics
- (6) 過渡応答（入力急変）特性 Dynamic line response characteristics
- (7) 出力保持時間特性 Hold up time characteristics
- (8) 入力電圧瞬停特性 Response to brown out characteristics

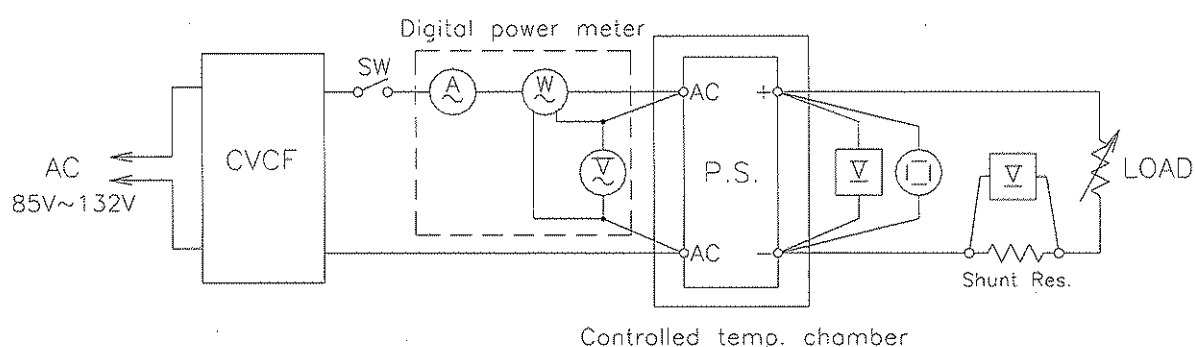

- (9) 過電流保護特性 Over current protection (OCP) characteristics

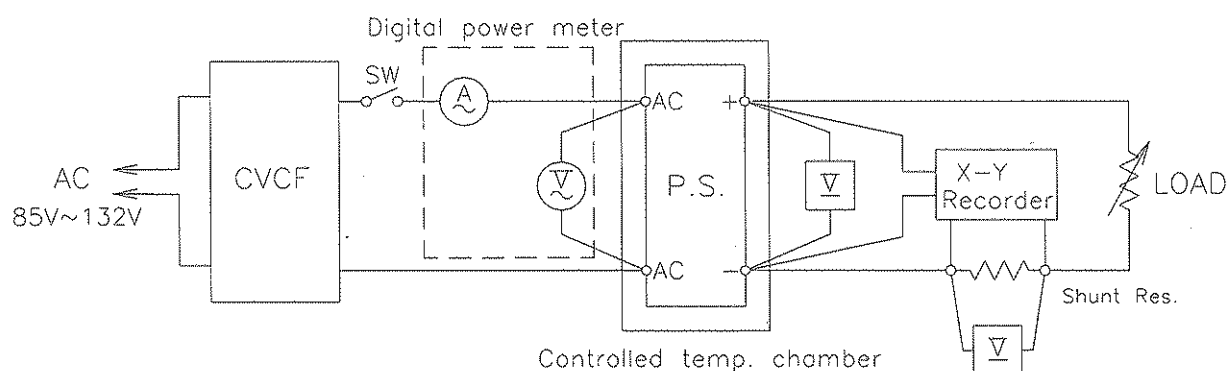

(10) 過渡応答 (負荷急変) 特性 Dynamic load response characteristics

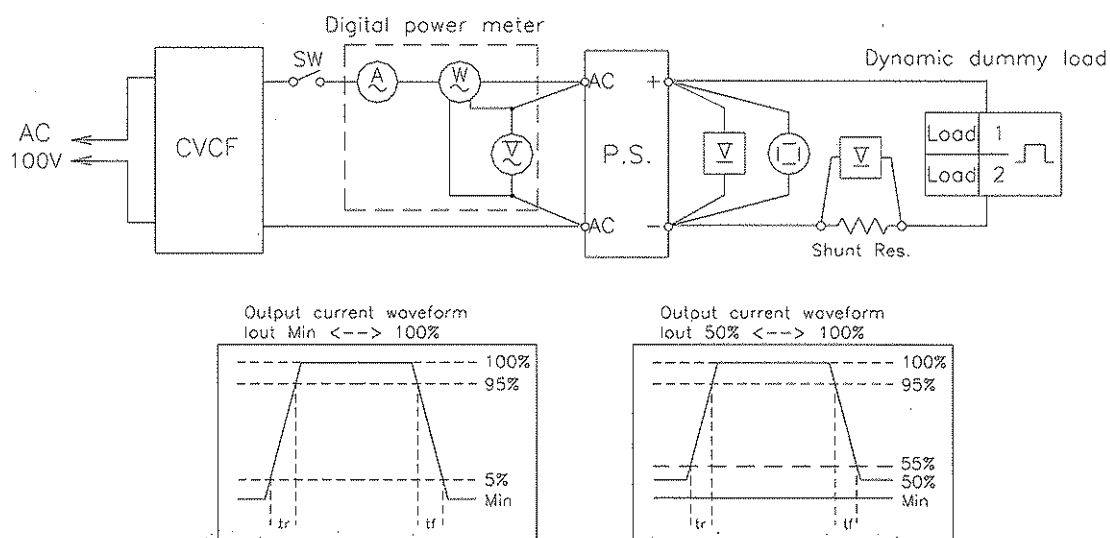

(11) 入力電サージ電流 (突入電流) 特性 Inrush current characteristics

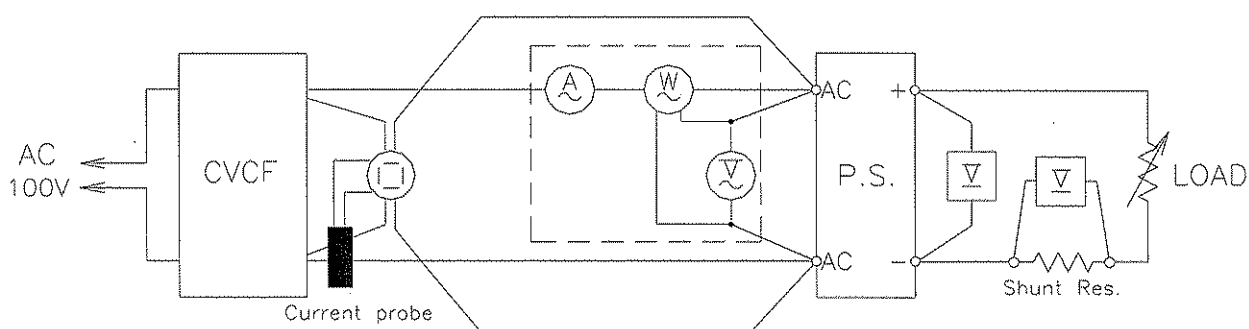

(12) リーク電流特性 Leakage current characteristics

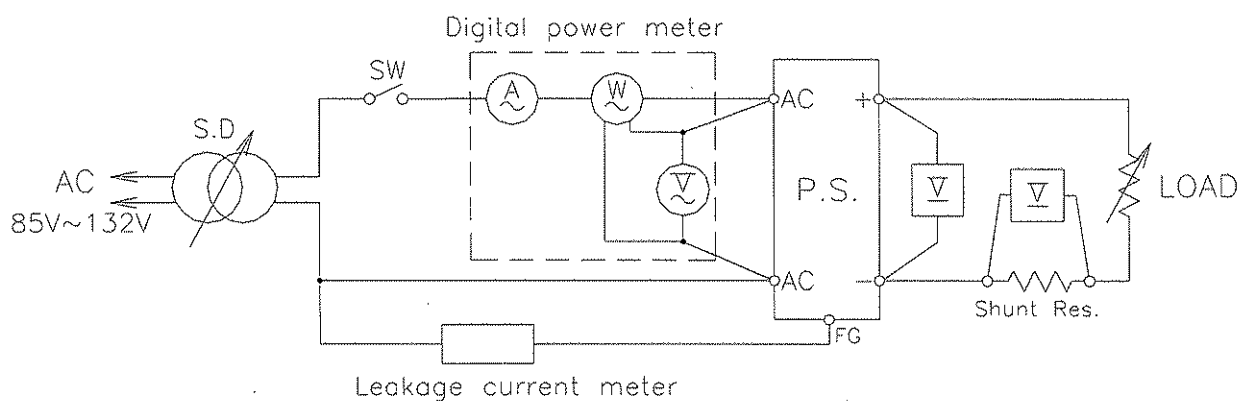

NOTE : Leakage current measured through a 1k ohm resistor.
 Range used---AC+DC (For YOKOGAWA TYPE 3226)
 ---AC (For SIMPSON MODEL 229-2)

(13) 出力リップル、ノイズ特性 Output ripple and noise characteristics

(a) Normal Mode (JEITA Standard RC-9131)

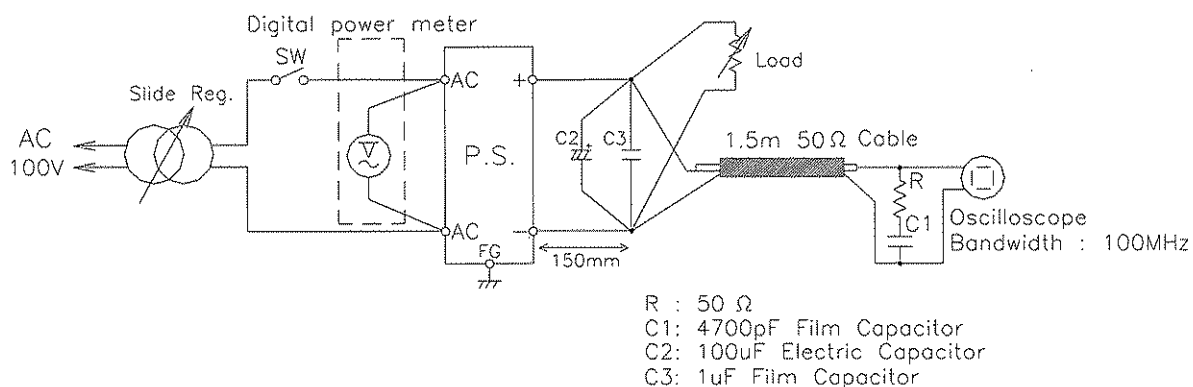

(b) Normal + Common Mode

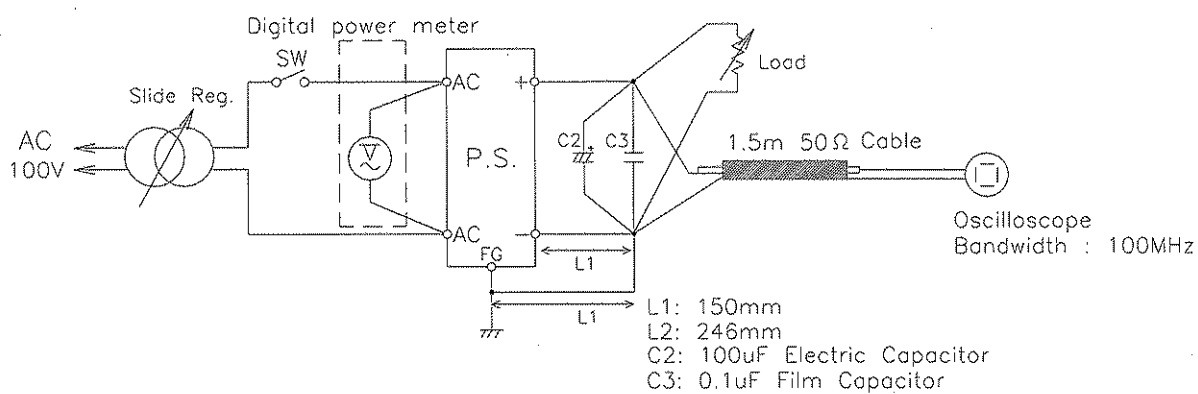

(14) EMI 特性 Electro-Magnetic Interference characteristics

(a) 雑音端子電圧 Conducted Emission Noise

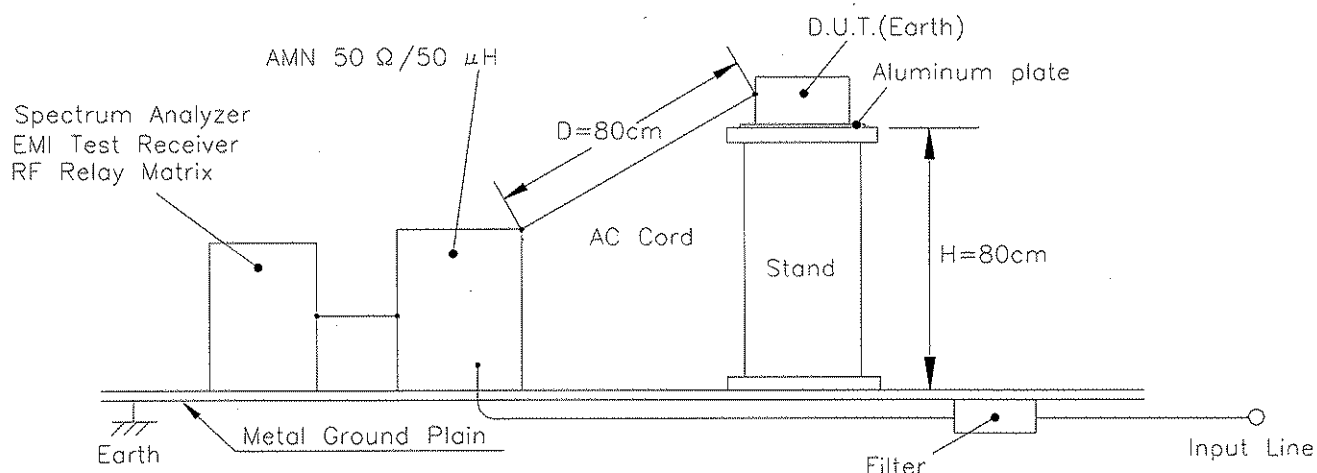

(b) 雑音電界強度 Radiated Emission Noise

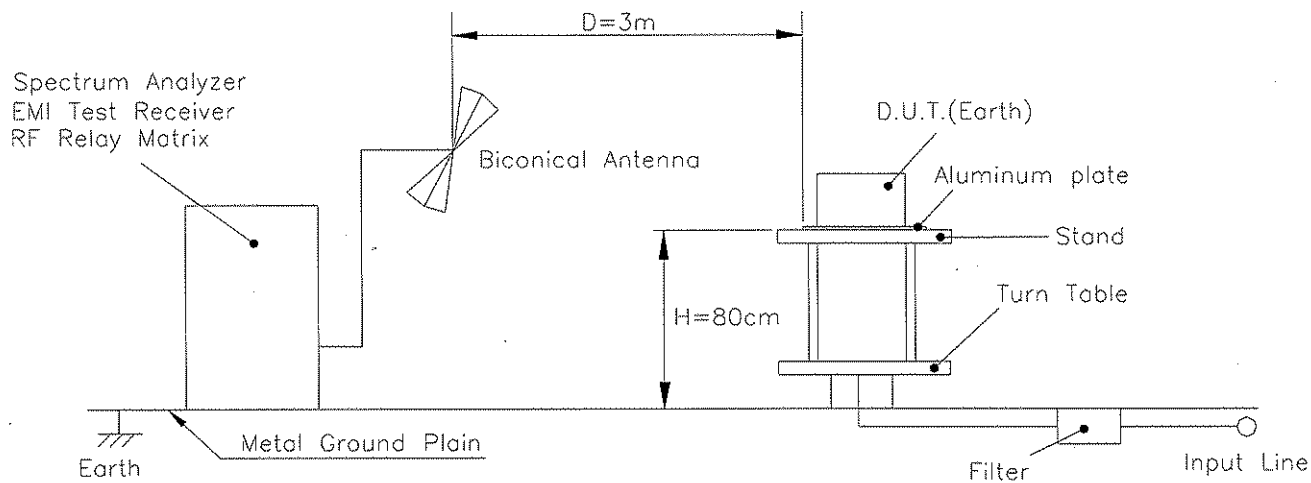

1.2 使用測定機器 List of equipment used

	EQUIPMENT USED	MANUFACTURER	MODEL NO.
1	OSCILLOSCOPE	HITACHI DENSHI	V-1565/V-1100A
2	DIGITAL STORAGE OSCILLOSCOPE	TEKTRONIX	TDS540D
3	DIGITAL MULTIMETER	YOKOGAWA ELECT.	7544/1/1
4	DIGITAL POWER METER	YOKOGAWA ELECT.	WT110
5	SHUNT RESISTOR	YOKOGAWA ELECT.	2215
6	CURRENT PROBE/AMPLIFIER	TEKTRONIX	TM502A/AM503
7	DYNAMIC DUMMY LOAD	TAKASAGO	FK-600L
8	SLIDE REGURATOR	MATSUNAGA	SD-2652
9	CVCF	TAKASAGO	AA2000XG
10	LEAKAGE CURRENT METER	SIMPSON	229-2
11	LEAKAGE CURRENT METER	YOKOGAWA	TYPE3226
12	CONTROLLED TEMP. CHANBER	TABAI ESPEC	SH-240
13	SPECTRUM ANALYZER	ROHDE & SCHWARZ	FSA
14	EMI TEST RECEIVER	ROHDE & SCHWARZ	ESHS10
15	EMI TEST RECEIVER	ROHDE & SCHWARZ	ESVS10
16	RF RELAY MATRIX	ROHDE & SCHWARZ	PSU
17	AMN	KYORITU DENSHI	KNW-242
18	ANTENA(BICONICAL ANTENA)	SCHWARZBECK	BBA9106
19	MULTIFUNCTION SYNTHESIZER	NF ELECTRONIC INSTRUMENTS	DF1940

2. 特性データ Characteristics

2.1 静特性 Steady state data

(1) 入力、負荷、温度変動

Regulation - Line and Load, Temperature drift

1. Regulation - Line and Load Condition Ta : 25°C

Iout \ Vin	85VAC	100VAC	132VAC	Line regulation	
	0%	24.075V	24.062V	24.057V	18mV
50%	24.068V	24.056V	24.052V	16mV	0.067%
100%	24.061V	24.051V	24.047V	14mV	0.058%
Load regulation	14mV	11mV	10mV		
	0.058%	0.046%	0.042%		

2. Temperature drift Conditions Vin : 100VAC

Iout : 100%

Ta	-10°C	+25°C	+50°C	Temperature stability	
Vout	24.163V	24.051V	23.925V	238mV	0.992%

(2) 出力電圧、リップル電圧 対 入力電圧

Output voltage and Ripple voltage v.s. Input voltage

Conditions Iout : 100%

Ta : -10°C -----

: 25°C - - - - -

: 50°C ———

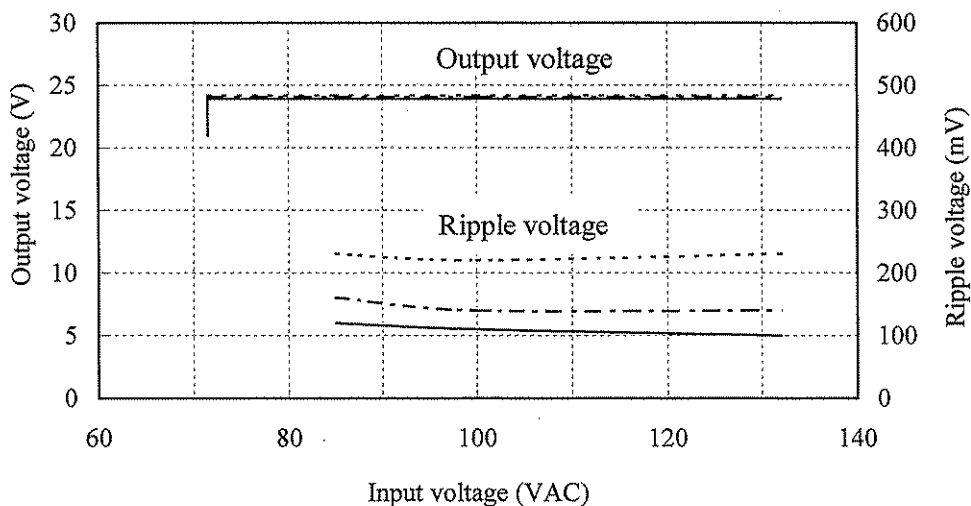

(3) 効率、入力電流 対 出力電流

Efficiency and Input current v.s. Output current

Conditions V_{in} : 85VAC -----
 : 100VAC - - - - -
 : 132VAC ————
 T_a : 25°C

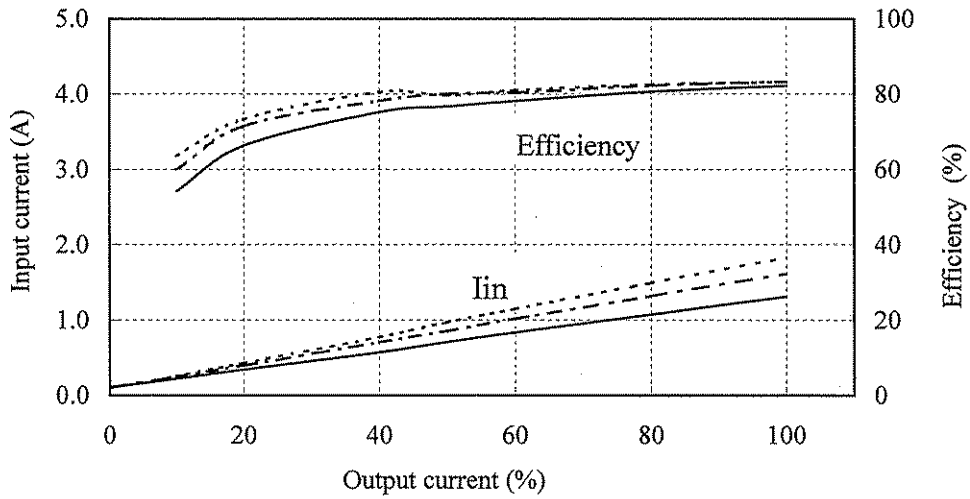

(4) 力率、入力電流 対 出力電流

Power factor and Input current v.s. Output current

Conditions V_{in} : 85VAC -----
 : 100VAC - - - - -
 : 132VAC ————
 T_a : 25°C

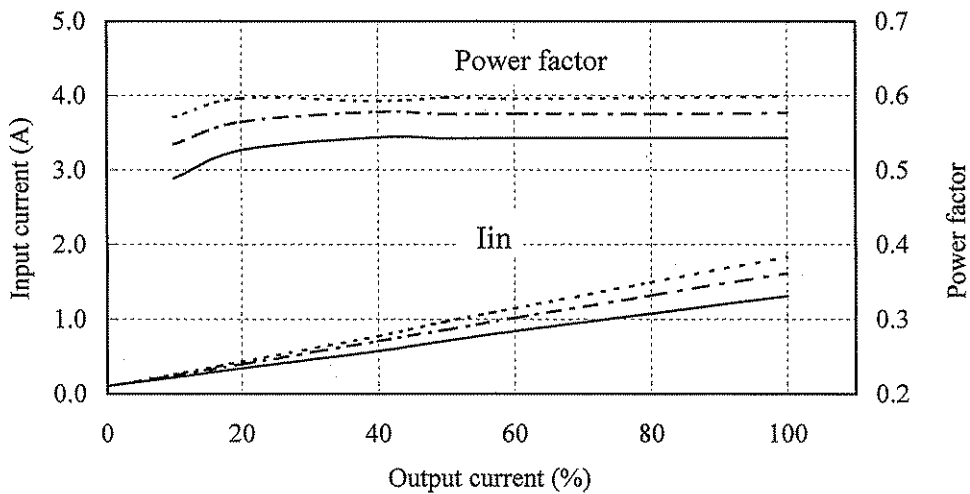

2.2 通電ドリフト特性

Warm up voltage drift characteristics

Conditions V_{in} : 100VAC

I_o : 100%

T_a : 25°C

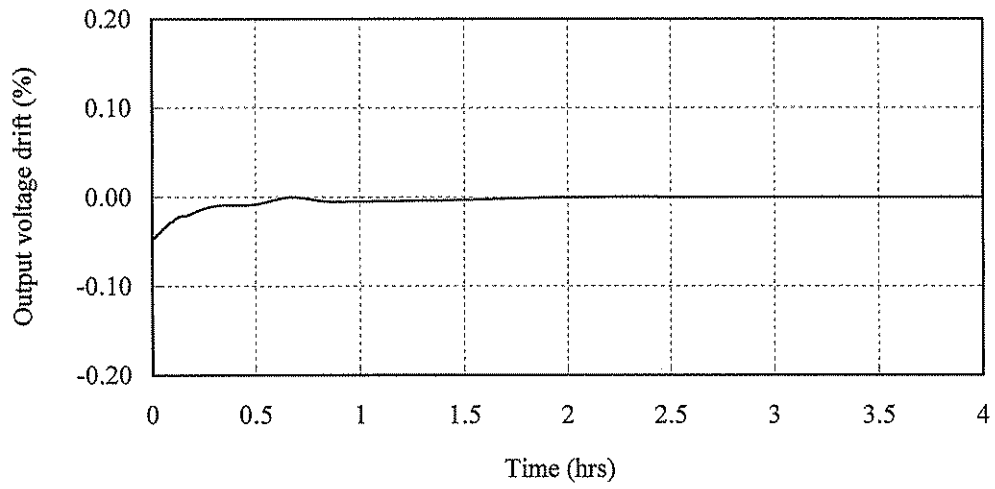

2.3 過電流保護特性

Over current protection (OCP) characteristics

Conditions Vin : 85VAC -----
 : 100VAC - - - - -
 : 132VAC ————
 Ta : 25°C

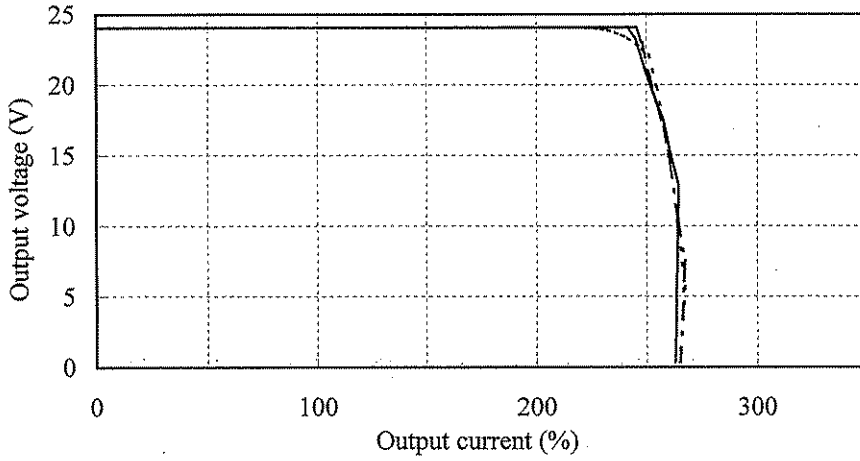

Conditions Vin : 100VAC
 Ta : -10°C -----
 : 25°C - - - - -
 : 50°C ————

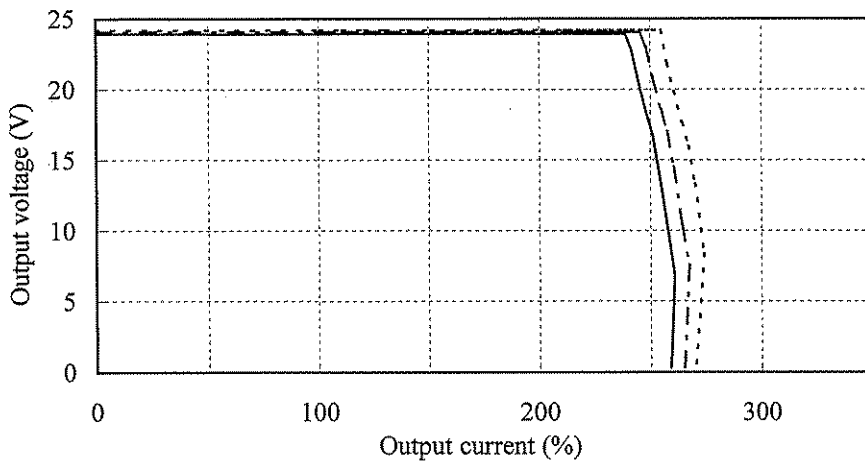

2.4 過電圧保護特性

Over voltage protection (OVP) characteristics

Conditions Vin : 100VAC
Iout : 0%
Ta : 25°C

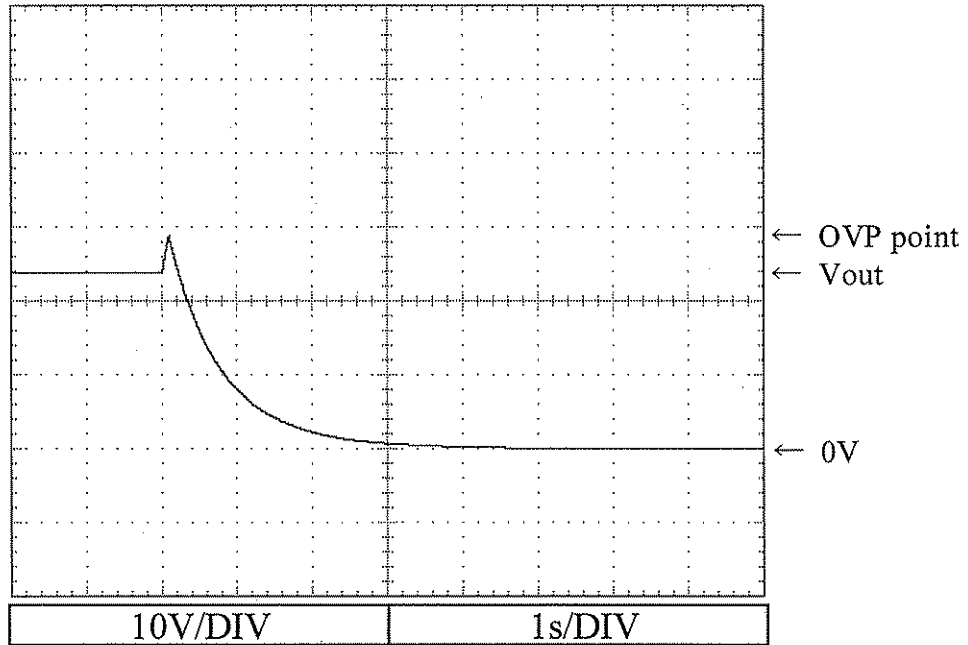

2.5 出力立ち上がり特性

Output rise characteristics

Conditions Vin : 85VAC (A)
 : 100VAC (B)
 : 132VAC (C)
 Iout : 0%
 Ta : 25°C

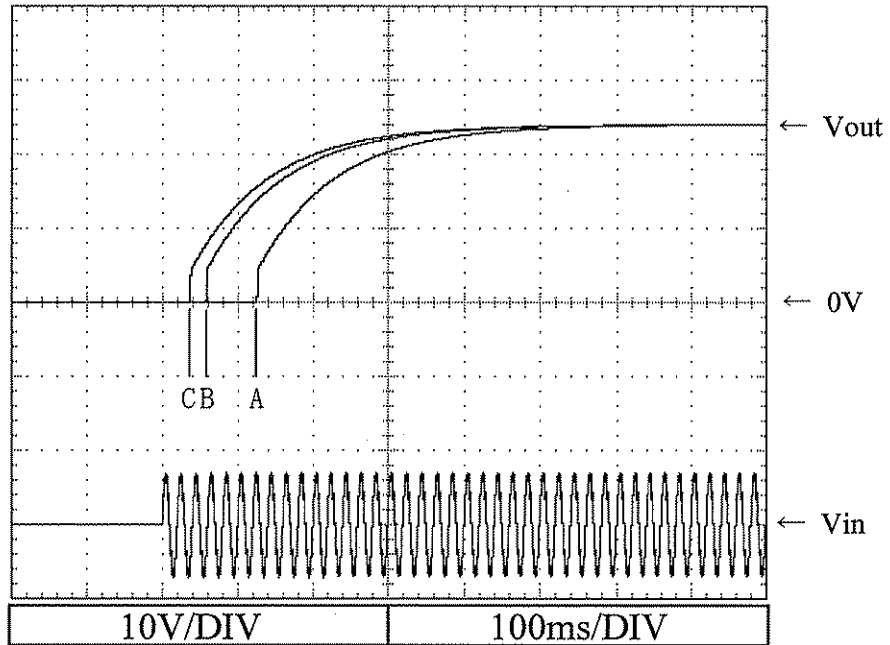

Conditions Vin : 85VAC (A)
 : 100VAC (B)
 : 132VAC (C)
 Iout : 100%
 Ta : 25°C

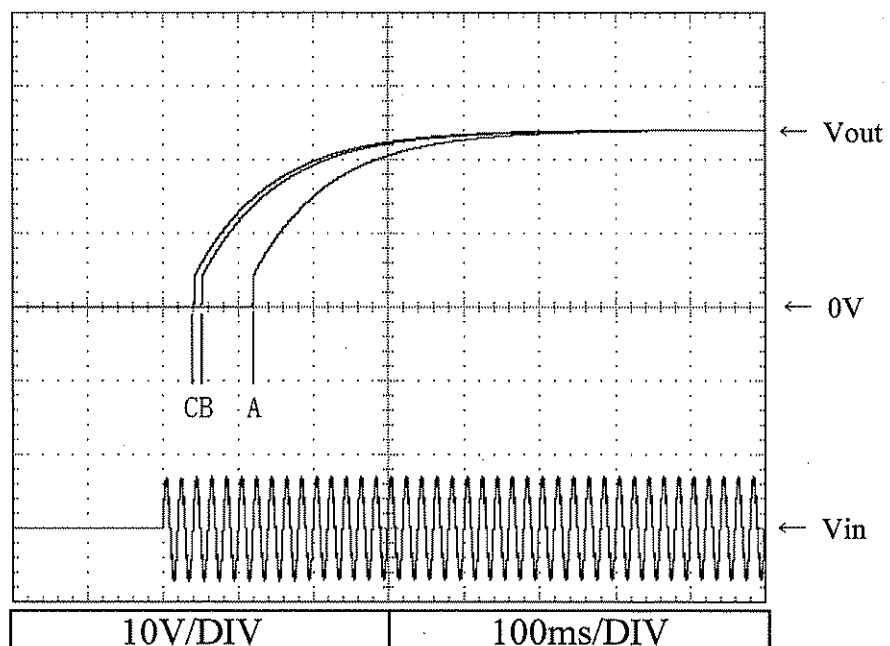

2.6 出力立ち下がり特性
Output fall characteristics

Conditions Vin : 85VAC (A)
: 100VAC (B)
: 132VAC (C)
Iout : 0%
Ta : 25°C

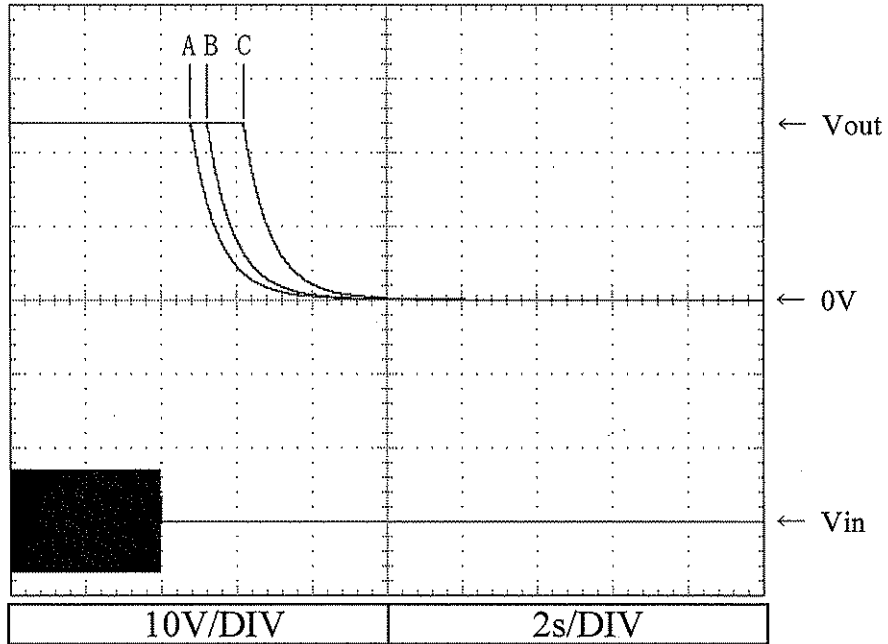

Conditions Vin : 85VAC (A)
: 100VAC (B)
: 132VAC (C)
Iout : 100%
Ta : 25°C

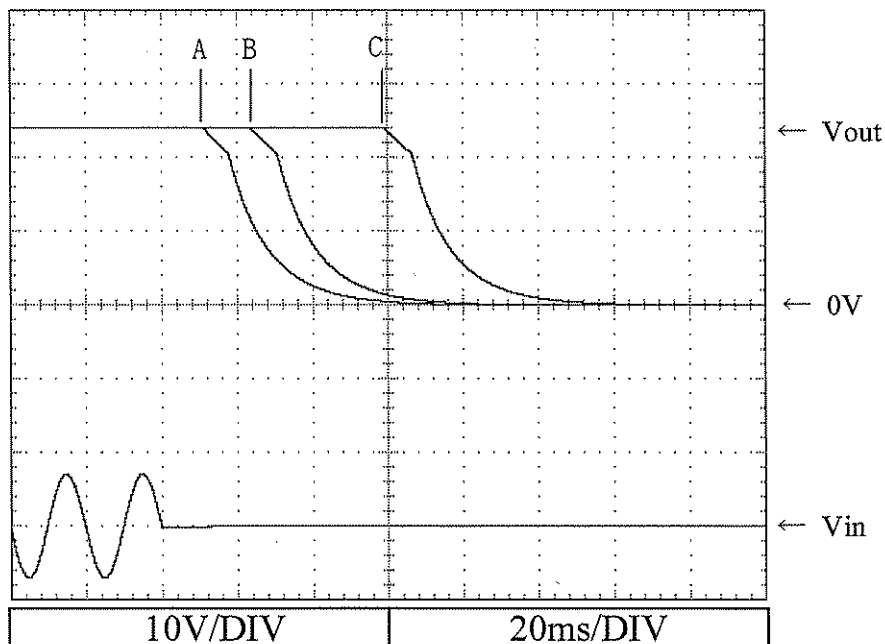

2.7 出力保持時間特性

Hold up time characteristics

Conditions V_{in} : 100VAC
 T_a : 25°C

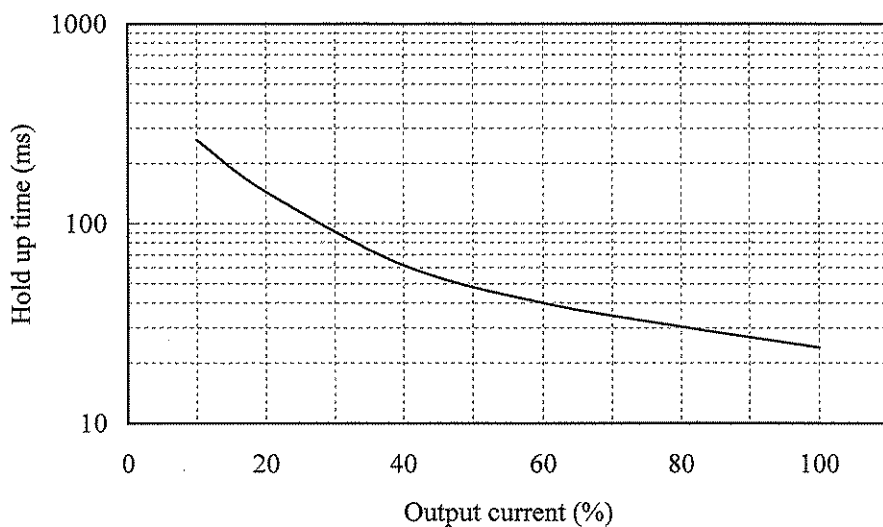

2.8 過渡応答 (入力急変) 特性

Dynamic line response characteristics

Conditions V_{in} : 85VAC \longleftrightarrow 132VAC
 I_{out} : 100%
 T_a : 25°C

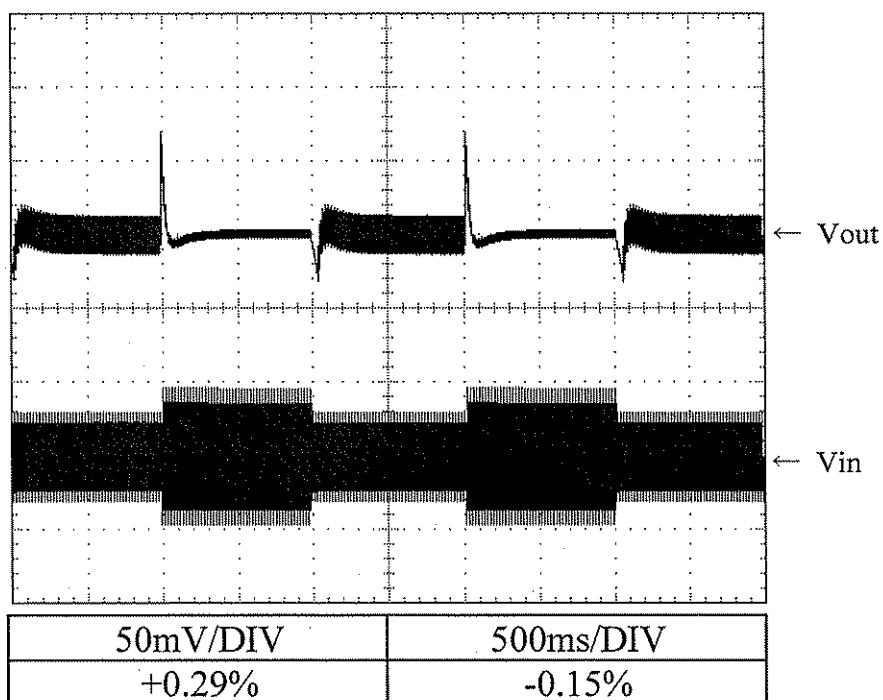

2.9 過渡応答（負荷急変）特性
Dynamic load response characteristics

Conditions V_{in} : 100VAC
 T_a : 25°C

$f=100\text{Hz}$

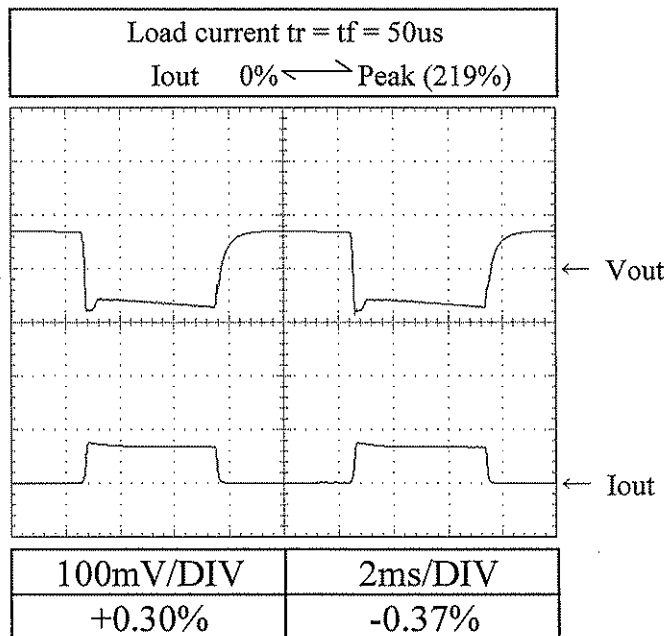
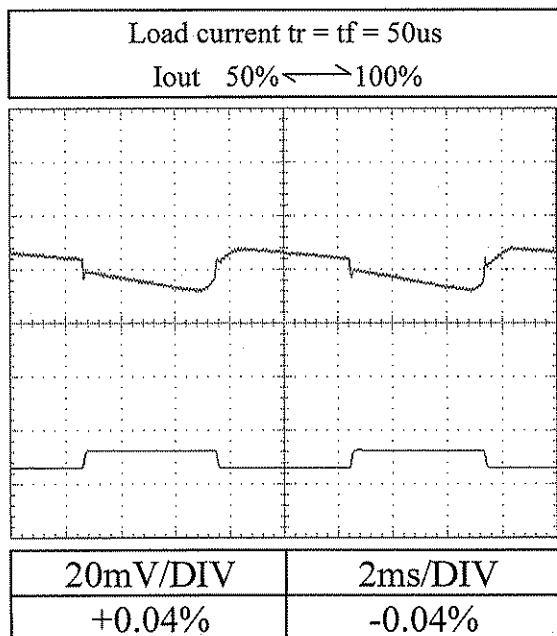

$f=1\text{kHz}$

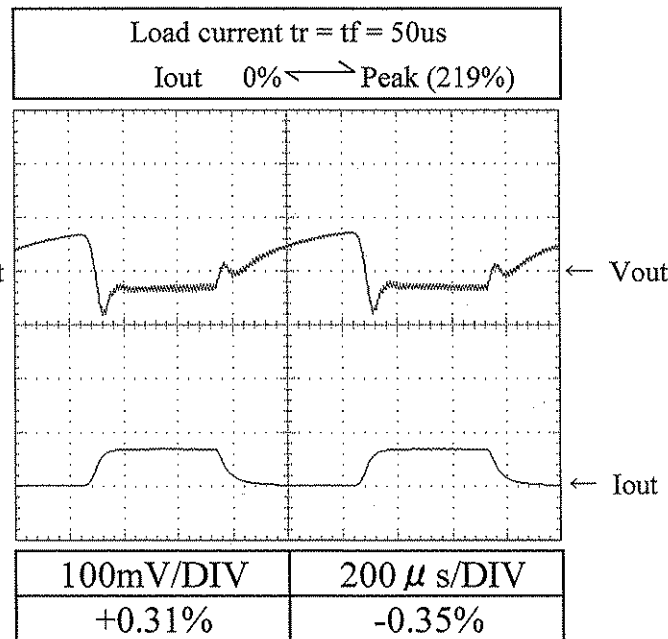
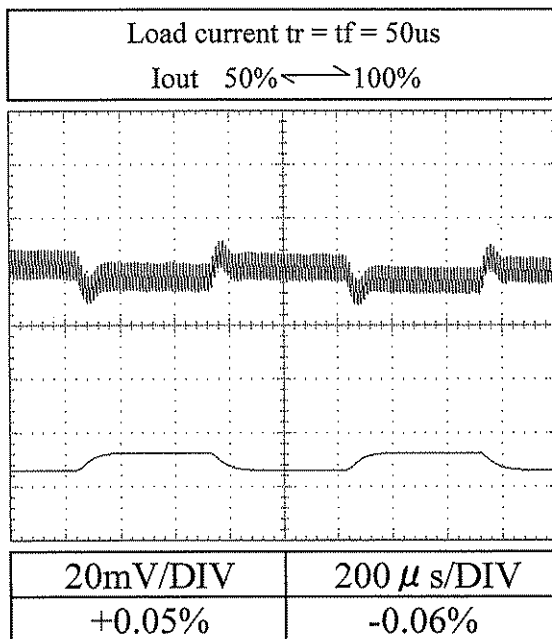

2.10 入力電圧瞬停特性

Response to brown out characteristics

Conditions V_{in} : 100VAC
 I_{out} : 100%
 T_a : 25°C

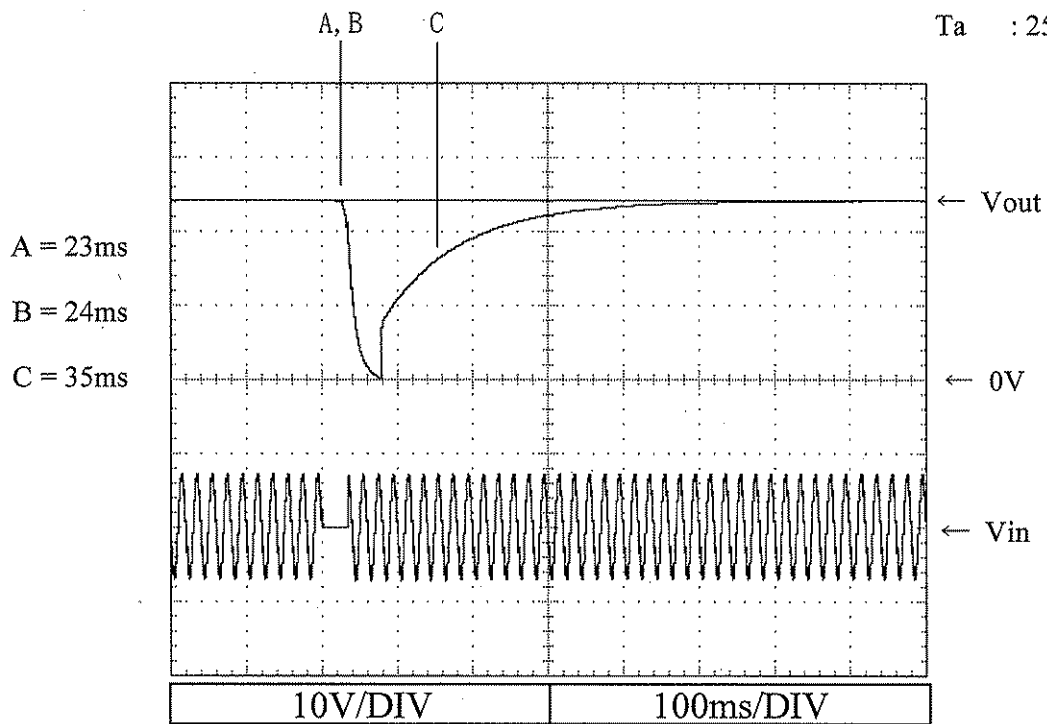

2.11 入力サージ電流（突入電流）特性
Inrush current waveform

Conditions Vin : 100VAC
Iout : 100%
Ta : 25°C

Switch on phase angle
of input AC voltage
 $\phi = 0^\circ$

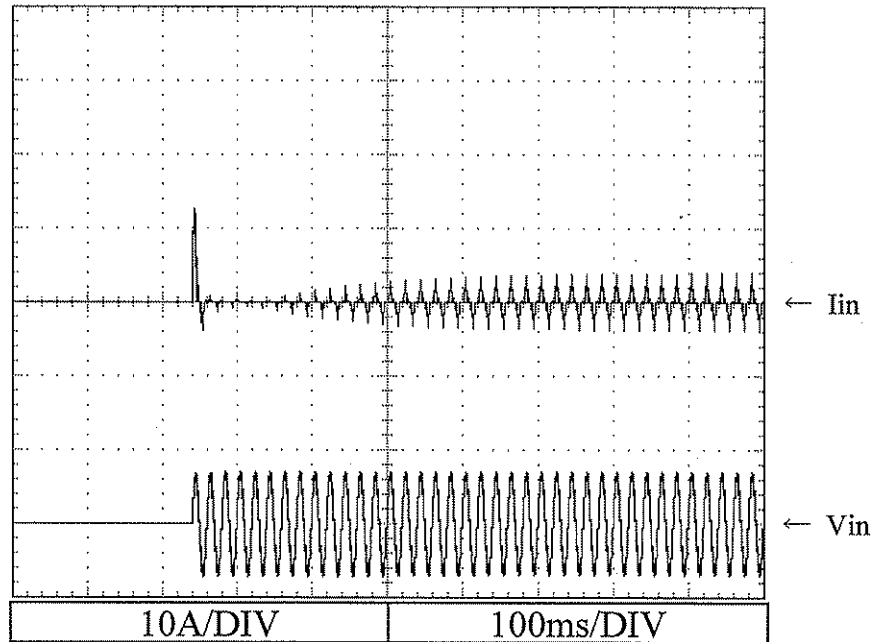

Switch on phase angle
of input AC voltage
 $\phi = 90^\circ$

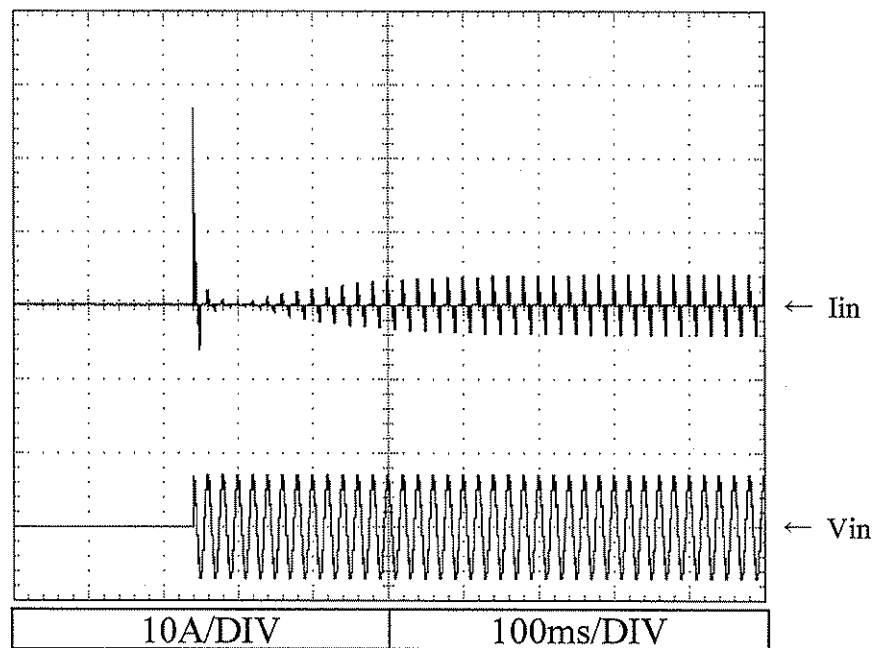

2.12 瞬停時突入電流特性
Inrush current characteristics

Conditions Vin : 100VAC
Iout : 0% -----
 : 50% - - - - -
 : 100% ————
Ta : 25°C

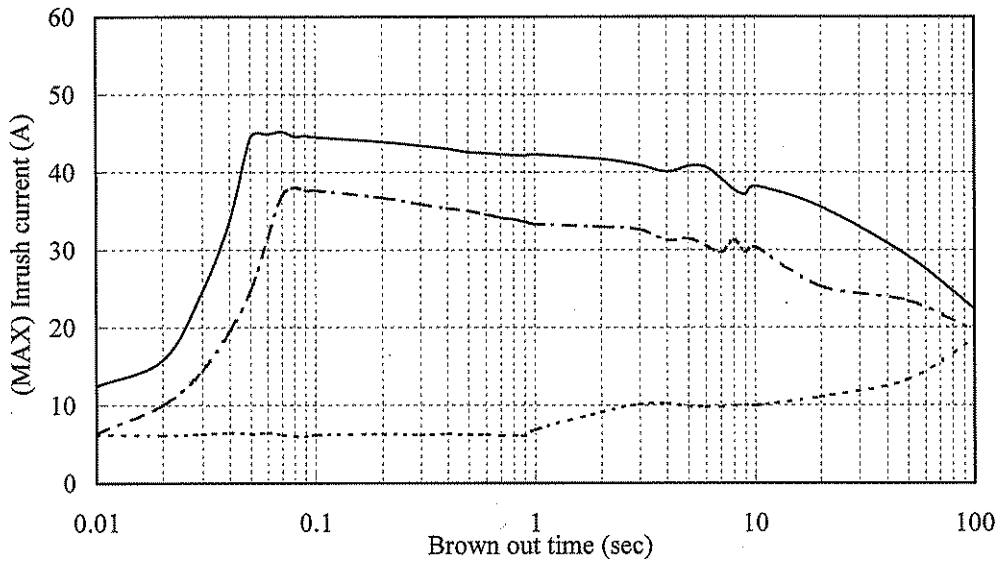

※ 上記値は、2次突入電流を含んだ値である。
Above data includes secondary inrush current.

2.13 入力電流波形
Input current waveform

Conditions Vin : 100VAC
Iout : 100%
Ta : 25°C

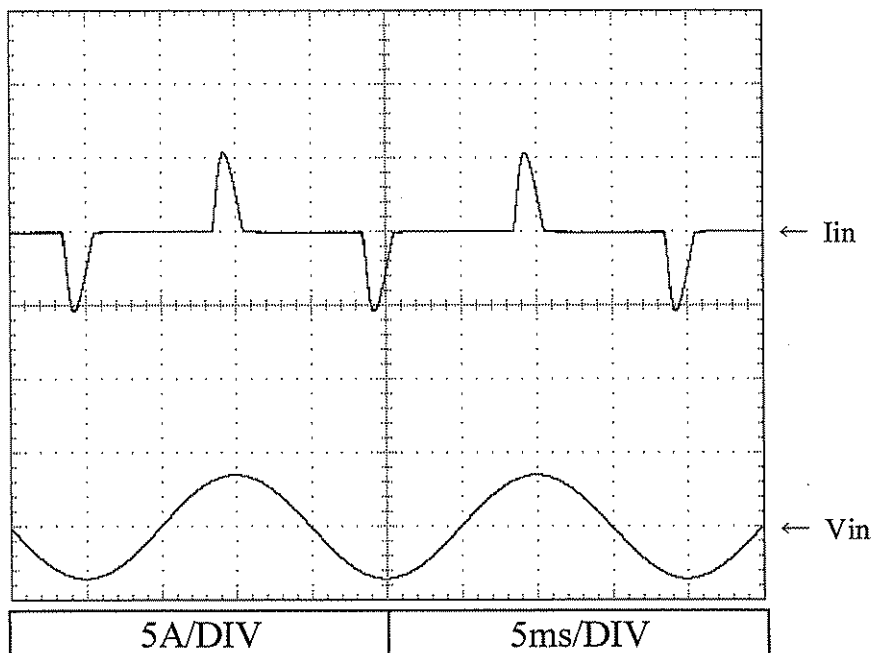

2.14 高調波成分
Input current harmonics

Conditions V_{in} : 100VAC
 I_{out} : 100%
 T_a : 25°C

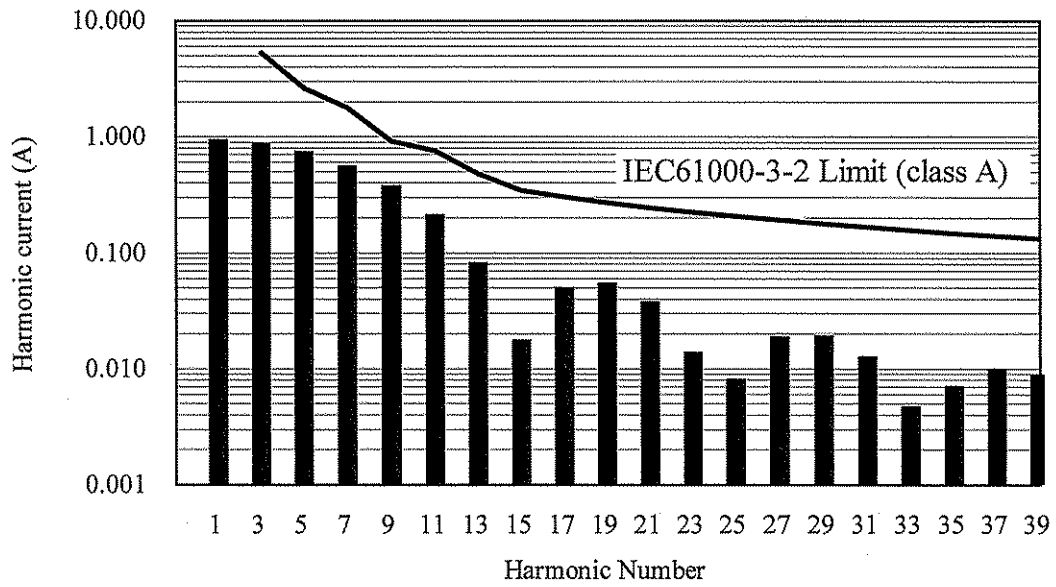

2.15 リーク電流特性
Leakage current characteristics

Conditions Iout : 0% -----
 : 100% —————
 Ta : 25°C
 f : 50Hz

Equipment used : MODEL 229-2 (SIMPSON)

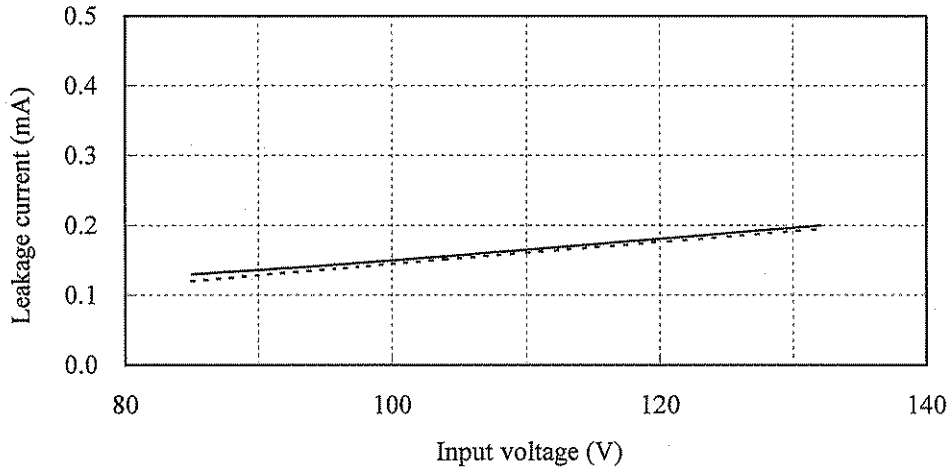

Equipment used : TYPE3226 (YOKOGAWA)

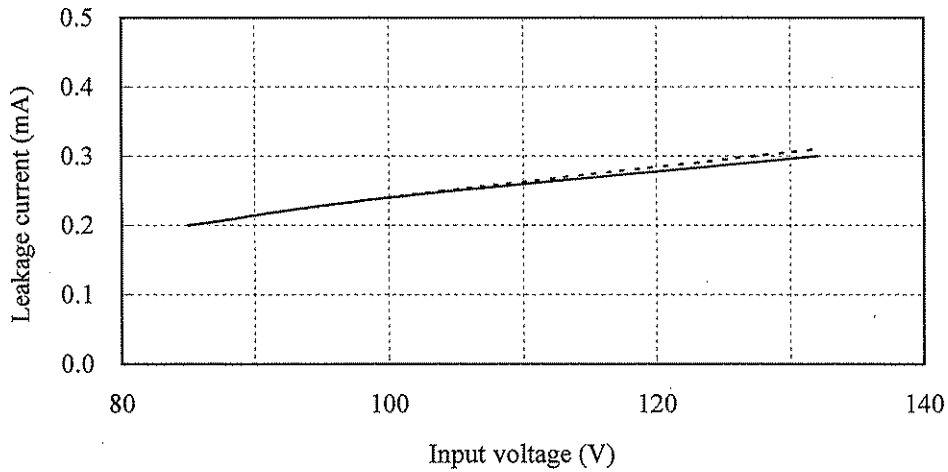

2.16 出力リップル、ノイズ波形
Output ripple and noise waveform

Conditions V_{in} : 100VAC
 I_{out} : 100%
 T_a : 25°C

NORMAL MODE

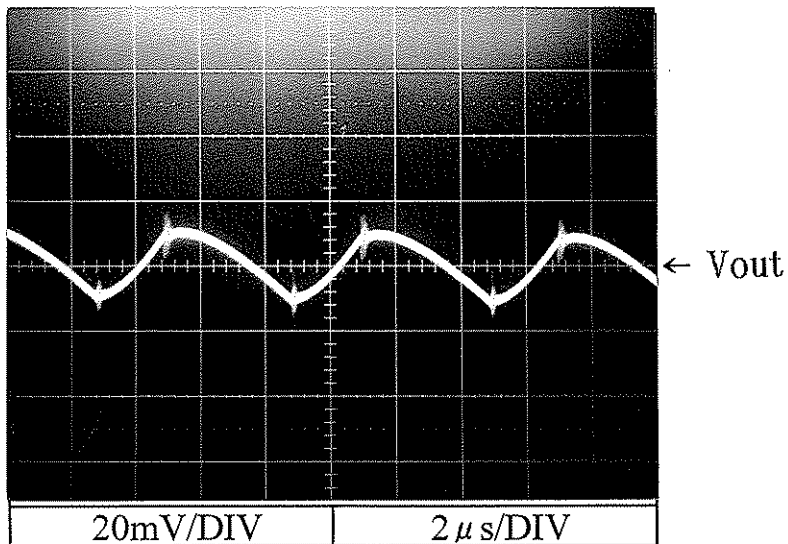

Conditions V_{in} : 100VAC
 I_{out} : 100%
 T_a : 25°C

NORMAL + COMMON MODE

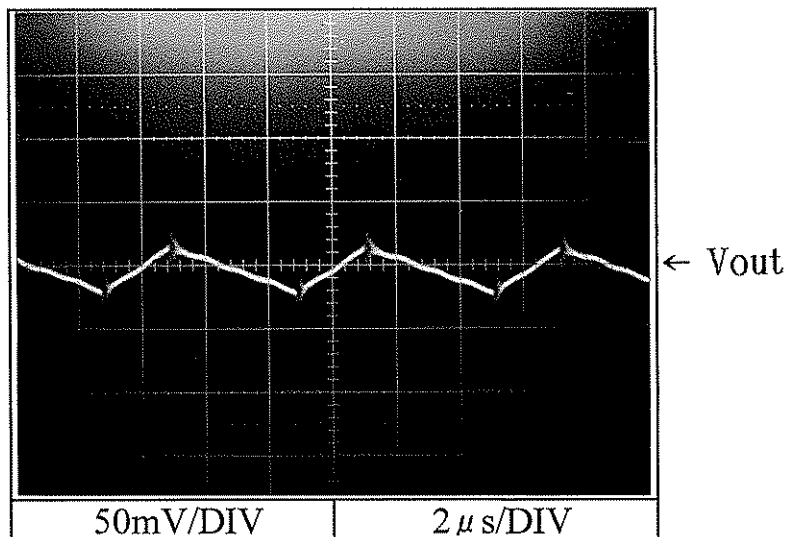

2.17 EMI特性

Electro-Magnetic Interference characteristics

Conditions Vin : 100VAC
Iout : 100%

雑音端子電圧

Conducted Emission

Point A (14.37MHz)		
Ref. Data	Limit (dBuV)	Measure (dBuV)
QP	60.0	46.0
AV	50.0	41.3

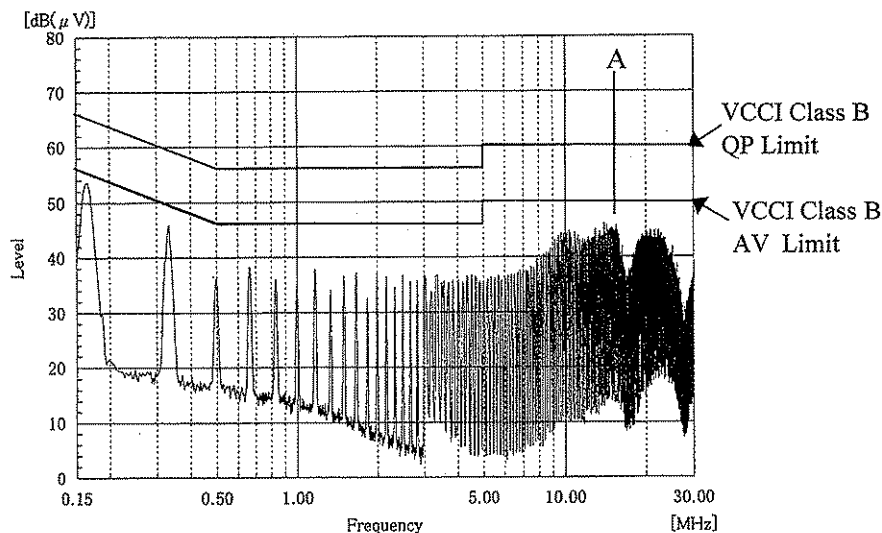

Phase : N

Point B (15.35MHz)		
Ref. Data	Limit (dBuV)	Measure (dBuV)
QP	60.0	49.4
AV	50.0	43.8

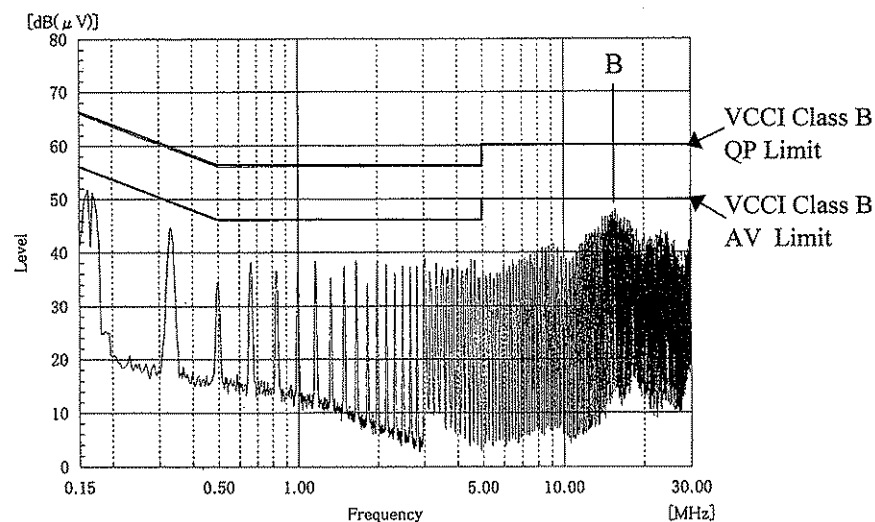

Phase : L

EN55011-B,EN55022-Bの限界値はVCCI class Bの限界値と同じ
Limit of EN55022-B are same as its VCCI class B.

Conditions Vin : 100VAC
Iout : 100%

雑音電界強度
Radiated Emission

HORIZONTAL:

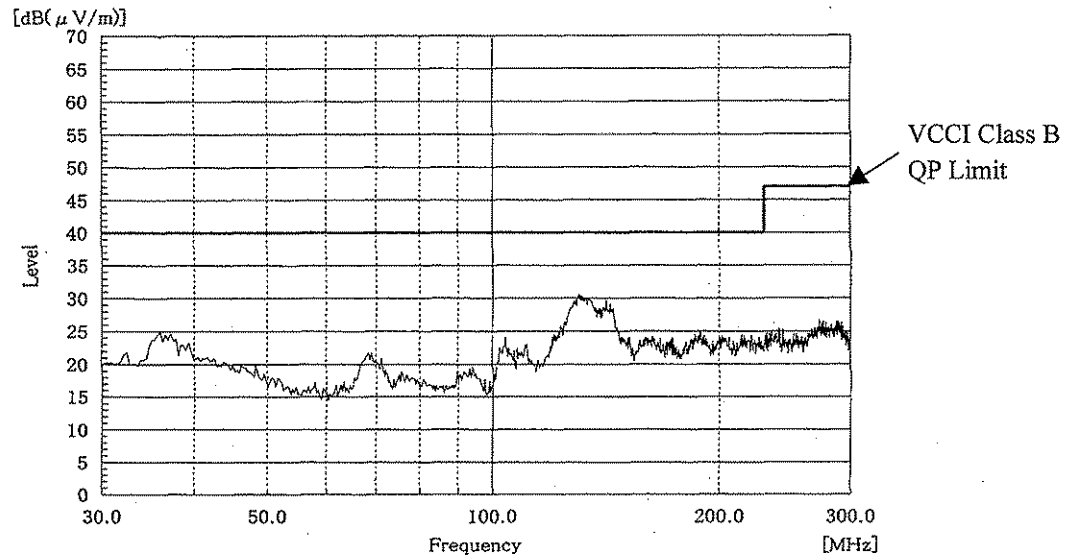

VERTICAL:

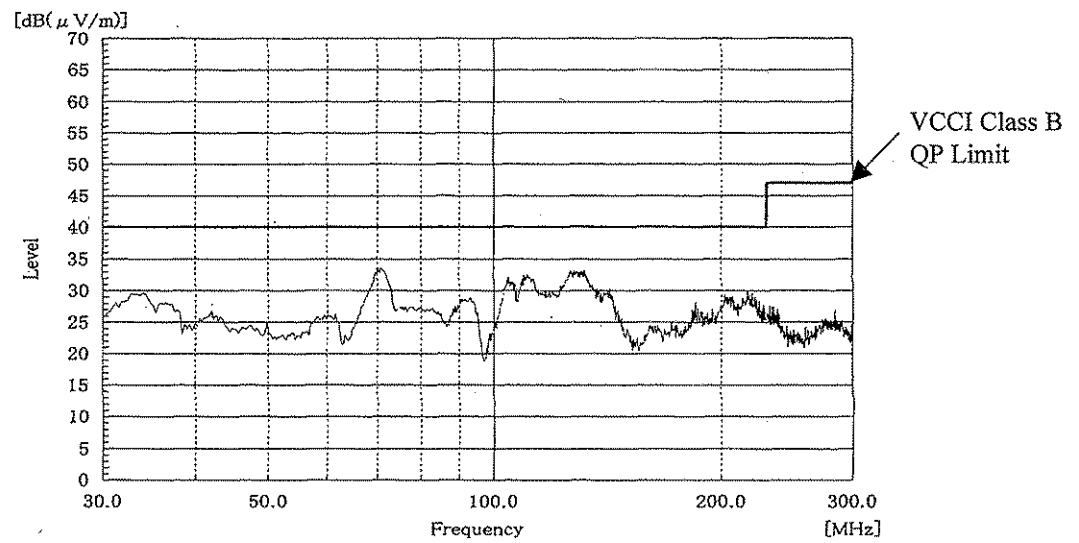

EN55011-B, EN55022-Bの限界値はVCCI class Bの限界値と同じ
Limit of EN55022-B are same as its VCCI class B.