



DRB240-48-1 Electromagnetic Compatibility Report 260666

1. Report Detail

Objective	To undertake measurements to determine the EUT's compliance with the specifications.	
Equipment under test	DIN Rail mounted Switched Mode Power Supply	
Manufacturer	TDK-Lambda UK Limited. Kingsley Avenue, Ilfracombe, Devon, EX34 8ES, United Kingdom	
Model	DRB240-48-1	
Units Tested ¹	See Appendix C – Equipment Under Test	
Test Engineers	Paul Dyer Stuart Nottage	Glen Moore Nick Heighington

1.1. Signatures

Signature			
Date	02/06/2020	02/06/2020	
Name	Stuart Nottage	Nick Heighington	Andrew Ford
Function	EMC Engineer	DVT Supervisor	Engineering Director

¹ Not all tests were carried out on every unit, details are given in Appendix C – Equipment Under Test as to which units were subjected to each test regime.

Written by:	Stuart Nottage	Revision	1		
Page	1 of 62	ECR	N/A		
		Date	27/05/2020		

DRB240-48-1 Electromagnetic Compatibility Report 260666

Figure 1 - Product Photograph



Written by:	Stuart Nottage	Revision	1		
Page	2 of 62	ECR	N/A		
		Date	27/05/2020		

2. Results Summary Table, DRB240-48-1

Specification ²	Title	Result	Comments
EN 61204-3	Low-voltage switch mode power supplies Part 3: Electromagnetic compatibility (EMC)	Compliant	Industrial Environment
CISPR 16-2-3 EN 55011	Radiated Electric Field Emissions 30MHz - 1000MHz	Class B ³	
CISPR 16-2-1 EN 55011	Conducted Emissions On Power Lines (AC Power Port) 150kHz – 30MHz	Class B	
EN 61000-3-2 EN 61000-4-7	Limits for harmonic current emissions (equipment input current <= 16 A per phase)	Class A	
EN 61000-3-3	Limitation of voltage fluctuations and flicker in low-voltage supply systems.	Pass	d _{max} = 2.1% Other aspects to be tested at system level.
EN 61000-4-2	Electrostatic discharge immunity test	Level 3	Criteria A
EN61000-4-3	Radiated, radio frequency, electromagnetic field immunity test, 80MHz – 6.0GHz	Level 3	Criteria A
EN 61204-3	Keyed Carrier	Pass	Criteria A
EN 61000-4-4	Electrical fast transient burst immunity test	Level 4	Criteria A
EN 61000-4-5	Surge Immunity test	Level 3	Criteria A
EN 61000-4-6	Immunity to conducted disturbances, induced by radio frequency fields	Level 3	Criteria A
EN 61000-4-8	Power frequency magnetic field immunity test	Level 4	Criteria A
EN 61000-4-11	Voltage dips, short interruptions and voltage variations immunity test	Class 3	Criteria A/B See Report

² See Appendix D – References for dates of standards used.

³ When tested following guidance in Application Notes. When tested according to EN61204-3 unit passes Class A.

Written by:	Stuart Nottage	Revision	1		
Page	3 of 62	ECR	N/A		
		Date	27/05/2020		

3. Table of Contents

1. Report Detail.....	1
2. Results Summary Table, DRB240-48-1	3
3. Table of Contents	4
4. System Configuration During EMC Testing.....	5
5. Product Standards	6
6. Radiated Electric Field Emissions 30MHz - 1000MHz to EN55011	8
7. Conducted Emissions, Mains Disturbance 0.15MHz to 30MHz to EN55011	23
8. Conducted Emissions On Power Lines (Harmonics) to EN61000-3-2	29
9. Limitation of Voltage Changes, Fluctuations & Flicker to EN61000-3-3.....	31
10. Immunity to Electrostatic Discharge to EN61000-4-2	32
11. Immunity to Radiated Electric Fields to EN61000-4-3	36
12. Immunity to Electrical Fast Transient Bursts to EN61000-4-4	40
13. Combination Wave Surge Immunity to EN61000-4-5	45
14. Immunity to Conducted RF Disturbances to EN61000-4-6	47
15. Power Frequency Magnetic Field Immunity to EN61000-4-8.....	50
16. Immunity to Voltage Dips, Interruptions and Variations to EN61000-4-11	53
Appendix A – Immunity Performance Criteria.....	55
Appendix B – Measurement Instrument Uncertainty	56
Appendix C – Equipment Under Test.....	59
Appendix D – References	60
Appendix E – Testing Locations.....	61
Appendix F – Revision History	62

Written by:	Stuart Nottage	Revision	1		
Page	4 of 62	ECR	N/A		
		Date	27/05/2020		

4. System Configuration During EMC Testing

The equipment under test (EUT) was configured for all testing as described below, details of test specific setup is given on the relevant pages.

4.1. Emission Testing

The EUT consisted of a DIN rail mounted switched mode power supply producing a single output. For emissions according to EN 61204-3 the power supply output was connected via approximately 1 m length of cable to load resistors, an LED was connected across each load to give a visual indication that the output was operational. For other emissions tests the load cable was approximately 30 cm in length. For some emissions the unit was tested mounted on a non metallic L shape bracket with a short length of DIN rail. For other emissions tests the unit was mounted within an enclosure. Full details are given on the relevant pages of this report.

4.2. Immunity Testing

The EUT was functioning correctly prior to each test and was configured as for stand-alone emission testing. The correct operation of the EUT was monitored throughout the test by a output monitor circuit attached to the output port and DC Good signal port. This is configured to detect changes in output as defined in Appendix A, Table 47. Additionally for some tests an oscilloscope is also used to monitor the output voltages. The EUT is tested to conform to performance criteria A or B dependant on test and level, see Appendix A for a full description of performance criteria.

4.3. EMC Performance

The EMC performance of a component power supply will be affected by the final installation, compliance to the stated EMC standards and conformance to the EMC Directive must be confirmed after installation by the final equipment manufacturer.

For guidance with respect to test conditions please see the Application Notes available on our website or contact your local TDK-Lambda sales office.

Written by:	Stuart Nottage	Revision	1		
Page	5 of 62	ECR	N/A		
		Date	27/05/2020		

5. Product Standards

5.1. EN 61204-3:2018 – Low-voltage switch mode power supplies - Part 3: Electromagnetic compatibility (EMC)

Chapter 6 – Emission Requirements

Section	Environmental Phenomenon	Test specification	Level Achieved
6.2.1	Commutation Notches	Not applicable to DBR120	
6.2.2	Current Harmonics and interharmonics	Class A	Class A
6.2.3	Voltage fluctuations and flicker	$d_{max} \leq 4\%$	2.1 %
6.3.2	High frequency conducted emission for input power ports	Class A limits of EN 55011 Table H.1	Class B
6.4.2	Radiated disturbance measurements	Class A limits of EN 55011 Table H.3	Class A

Warning: This is a product designed for an industrial environment. In a residential, commercial or light industrial environment it may cause radio interference. The user may be required to take adequate measures to reduce interference.

Table 6 – Immunity – Enclosure Ports – Industrial Environment

Section	Environmental Phenomenon	Test specification	Performance Criteria	Level Achieved	Criteria Achieved
6-1	Electrostatic discharge	Contact ± 4 kV Air ± 8 kV	B B	Contact ± 8 kV Air: No test	A A
6-2	Radio-frequency electromagnetic field amplitude modulated	80 to 1000 MHz 10 V/m 80 % AM (1 kHz)	A	80 to 1000 MHz 10 V/m 80 % AM (1 kHz)	A
6-3	Radio-frequency electromagnetic field amplitude modulated	1.4 to 2.0 GHz 3 V/m 80 % AM (1 kHz)	A	1.4 to 2.0 GHz 10 V/m 80 % AM (1 kHz)	A
6-4	Radio-frequency electromagnetic field amplitude modulated	2.0 to 2.7 GHz 1 V/m 80 % AM (1 kHz)	A	2.0 to 2.7 GHz 10 V/m 80 % AM (1 kHz)	A
6-5	Power-frequency magnetic field	50, 60 Hz 30 A/m	A	50, 60 Hz 30 A/m	A

Table 7 – Immunity – Ports for signal lines and control lines – Industrial Environment

Section	Environmental Phenomenon	Test specification	Performance Criteria	Level Achieved	Criteria Achieved
7-1	Fast transients	± 1 kV 5/50 ns 100 kHz	B	± 2 kV 5/50 ns 5 kHz and 100 kHz	A
7-2	Radio-frequency common mode	0.15 – 80 MHz 10 V 80 % AM (1kHz)	A	0.15 – 80 MHz 10 V 80 % AM (1kHz)	A

Written by:	Stuart Nottage	Revision	1		
Page	6 of 62	ECR	N/A		
		Date	27/05/2020		

DRB240-48-1 Electromagnetic Compatibility Report 260666

Table 8 – Immunity – DC input and output power ports – Industrial Environment

Section	Environmental Phenomenon	Test specification	Performance Criteria	Level Achieved	Criteria Achieved
8-1	Fast transients	± 2 kV 5/50 ns 100 kHz	B	± 4 kV 5/50 ns 5 kHz and 100 kHz	A
8-2	Surges Line- to-earth Line-to-line	1.2/50 (8/20) µs ± 0.5 kV ± 0.5 kV	B	Output lines are not intended to connect directly cables the total length of which may exceed 30m. Where this is required additional system level protection shall be used.	
8-3	Radio-frequency common mode	0.15 – 80 MHz 10 V 80 % AM (1kHz)	A	0.15 – 80 MHz 10 V 80 % AM (1kHz)	A

Table 9 – Immunity – AC Input power ports – Industrial Environment

Section	Environmental Phenomenon	Test specification	Performance Criteria	Level Achieved	Criteria Achieved
9-1	Fast transients	± 2 kV 5/50 ns 100 kHz	B	± 4 kV 5/50 ns 5 kHz and 100 kHz	A
9-2	Surges Line- to-earth Line-to-line	1.2/50 (8/20) µs ± 2 kV ± 1 kV	B	1.2/50 (8/20) µs ± 2 kV ± 1 kV	A
9-3	Voltage dips	0% residual voltage ½ cycle	B	0% residual voltage ½ cycle	A
		0% residual voltage 1 cycle	B	0% residual voltage 1 cycles	A
		40% residual voltage 10/12 cycles at 50/60Hz	C	40% residual voltage 10/12 cycles at 50/60Hz	B
		70% residual voltage 25/30 cycles at 50/60Hz	C	70% residual voltage 25/30 cycles at 50/60Hz	B
		80% residual voltage 250/300 cycles at 50/60Hz	C	80% residual voltage 250/300 cycles at 50/60Hz	A
9-4	Voltage Interruptions	0% residual voltage 250/300 cycles at 50/60Hz	C	0% residual voltage 250/300 cycles at 50/60Hz	B
9-5	Radio-frequency common mode	0.15 – 80 MHz 10 V 80 % AM (1kHz)	A	0.15 – 80 MHz 10 V 80 % AM (1kHz)	A

Written by:	Stuart Nottage	Revision	1		
Page	7 of 62	ECR	N/A		
		Date	27/05/2020		

6. Radiated Electric Field Emissions 30MHz - 1000MHz to EN55011

6.1. Enclosure Port - Test Procedure.

For radiated emissions the EUT's were setup in three different configurations to cover the requirements of the relevant standards, full details given on the pages that follow. Measurements were taken in a Semi-Anechoic chamber at a distance of 3m and were obtained with the antenna in horizontal and vertical polarisations. The pre-scan was taken using a peak detector whilst rotating the unit, to give a scan for approximately every 10° of rotation. This was repeated with the antenna height adjusted between 1m and 4 m in 0.5 m steps. This pre-scan gives a list of highest emissions, these emissions were then formally measured using a Quasi-Peak detector. Details of the highest emissions are presented below.

Table 1 - Radiated Emissions

Standard	Frequency (MHz)	Field Strength in Standard	Field Strength, 3m (dBµV/m)
EN55011 Class B	30MHz – 230MHz	40dBµV/m	40.00
	230MHz – 1000MHz	47dBµV/m	47.00
EN55011 Class A	30MHz – 230MHz	50dBµV/m	50.00
	230MHz – 1000MHz	57dBµV/m	57.00

Figure 2 - Test Setup, Radiated Emissions

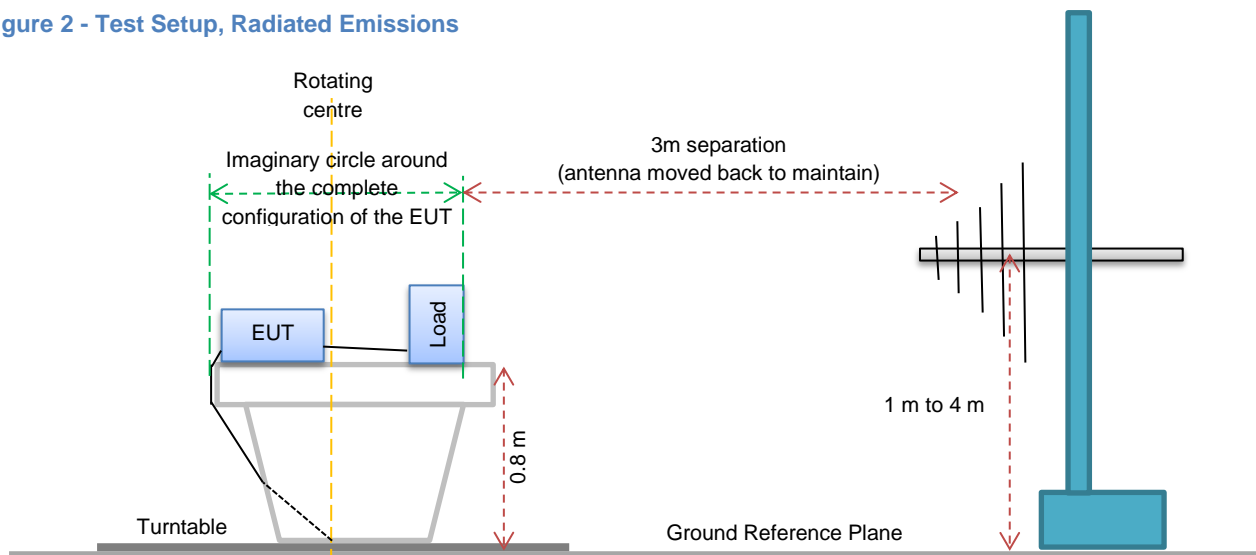

Written by:	Stuart Nottage	Revision	1		
Page	8 of 62	ECR	N/A		
		Date	27/05/2020		

6.2. Test Results

The levels of the highest emissions measured in accordance with the specification are presented below. The emission with the least margin is highlighted.

Table 2 - Radiated Electric Field Emissions, DRB240-48-1, Summary

Model	Input Voltage	Load	Minimum Margin (dB μ V/m)		
			EN61204-3 Class A	EN 55011 Stand-Alone Class A	EN 55011 Enclosure Class B
48V	100V	0%	20.4	20.3	10.0
		50%	7.9	7.2	4.9
		100%	4.7	10.2	10.8
	230V	0%	20.0	22.8	13.3
		50%	12.4	12.0	6.6
		100%	9.5	10.9	10.6
2 x 48V series	100V	0%	6.7	19.6	
		50%	11.6	8.9	11.3
		100%	11.1	9.8	
	230V	0%	3.8	19.7	
		50%	7.9	15.7	11.8
		100%	11.9	11.4	

The worst case operating conditions for each test are highlighted in the table above, so below only these results are given to save space, however all other results are available on request. Contact your local TDK-Lambda Technical Support for a copy.

6.2.1. EN 61204-3 Configuration

EN 61204-3 section 6.4.2 requires that radiated emissions are tested as follows:

“Load cables of unknown length shall be arranged horizontally, equally separated from each other and shall be 1 m in length. The mains cable is arranged 1 m horizontally and then 0,8 m vertically to the ground where it is connected to the power source. Cables are unshielded.”

For the testing, to connect the power to the socket in the turntable a CMAD was used in accordance with EN 55011:2016 +A1:2017

Written by:	Stuart Nottage	Revision	1		
Page	9 of 62	ECR	N/A		
		Date	27/05/2020		

DRB240-48-1 Electromagnetic Compatibility Report 260666

Figure 3 - Test Configuration, Radiated Emissions, EN 61204-3,

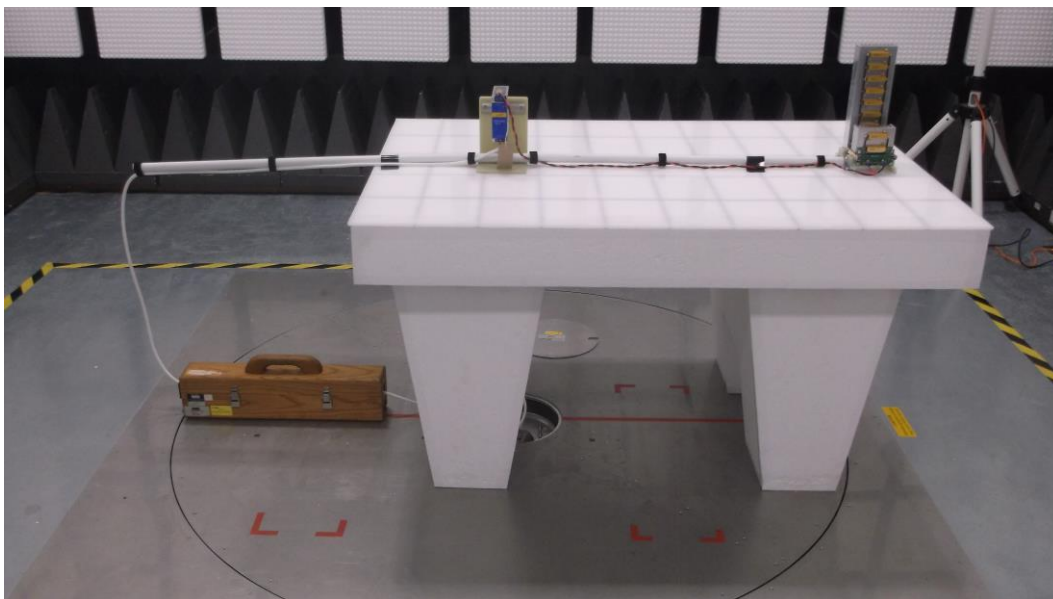
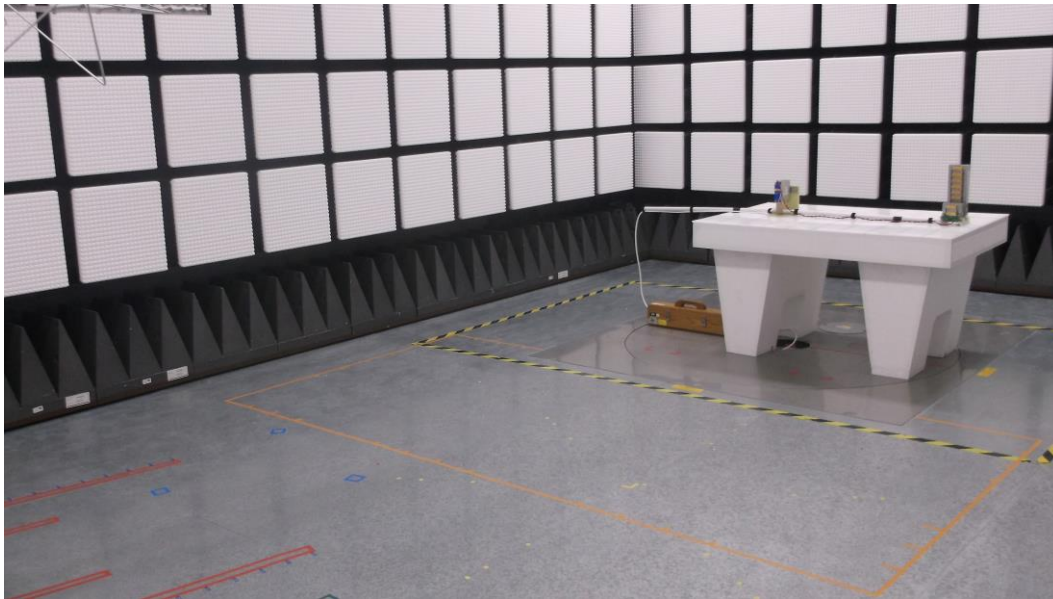

Written by:	Stuart Nottage	Revision	1		
Page	10 of 62	ECR	N/A		
		Date	27/05/2020		

DRB240-48-1 Electromagnetic Compatibility Report 260666

Figure 4 - Radiated Electric Field Emissions, DRB120-12-1, 100Vac, 100% Load, EN61204-3

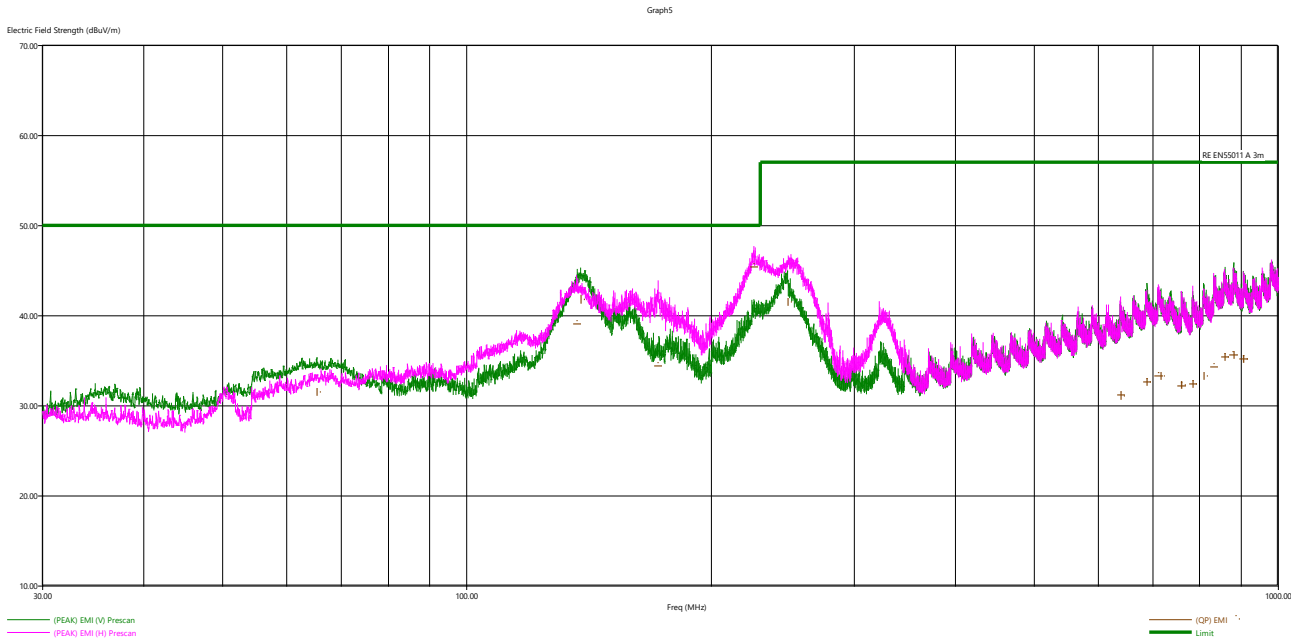

Table 3 - Radiated Electric Field Emissions, DRB120-12-1, 100Vac, 100% Load, EN61204-3

Frequency (MHz)	Polarisation	EUT Angle (Degrees)	Tower Height (cm)	Quasi-Peak (dBµV/m)	Limit (dBµV/m)	Margin (dB)
136.53	H	335.5	249	38.97	50.00	11.03
172.08	H	239.0	199	34.36	50.00	15.64
225.78	H	62.6	149	45.29	50.00	4.71
710.85	H	300.9	399	33.23	57.00	23.77
832.17	H	208.5	349	34.25	57.00	22.75
858.36	H	351.5	299	35.31	57.00	21.69
880.47	H	39.5	149	35.51	57.00	21.49
905.40	H	325.4	101	35.09	57.00	21.91
65.31	V	290.5	149	31.39	50.00	18.61
138.06	V	61.6	120	41.70	50.00	8.30
248.19	V	88.4	120	41.43	57.00	15.57
859.47	V	12.5	149	35.34	57.00	21.66
880.56	V	305.0	349	35.57	57.00	21.43
905.16	V	12.5	199	35.17	57.00	21.83

Written by:	Stuart Nottage	Revision	1		
Page	11 of 62	ECR	N/A		
		Date	27/05/2020		

DRB240-48-1 Electromagnetic Compatibility Report 260666

Figure 5 - Test Configuration, Radiated Emissions, Stand Alone,

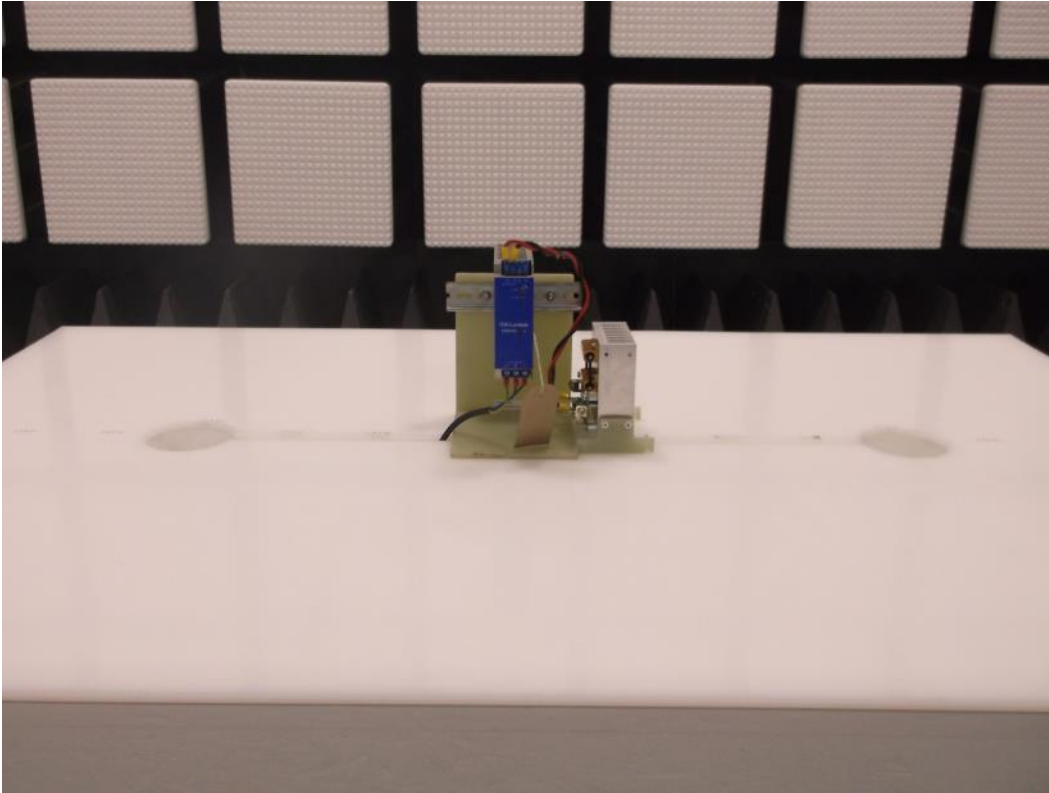

Written by:	Stuart Nottage	Revision	1		
Page	12 of 62	ECR	N/A		
		Date	27/05/2020		

DRB240-48-1 Electromagnetic Compatibility Report 260666

Figure 6 - Radiated Electric Field Emissions, DRB120-12-1, 100Vac, 50% Load, EN55011 Stand Alone

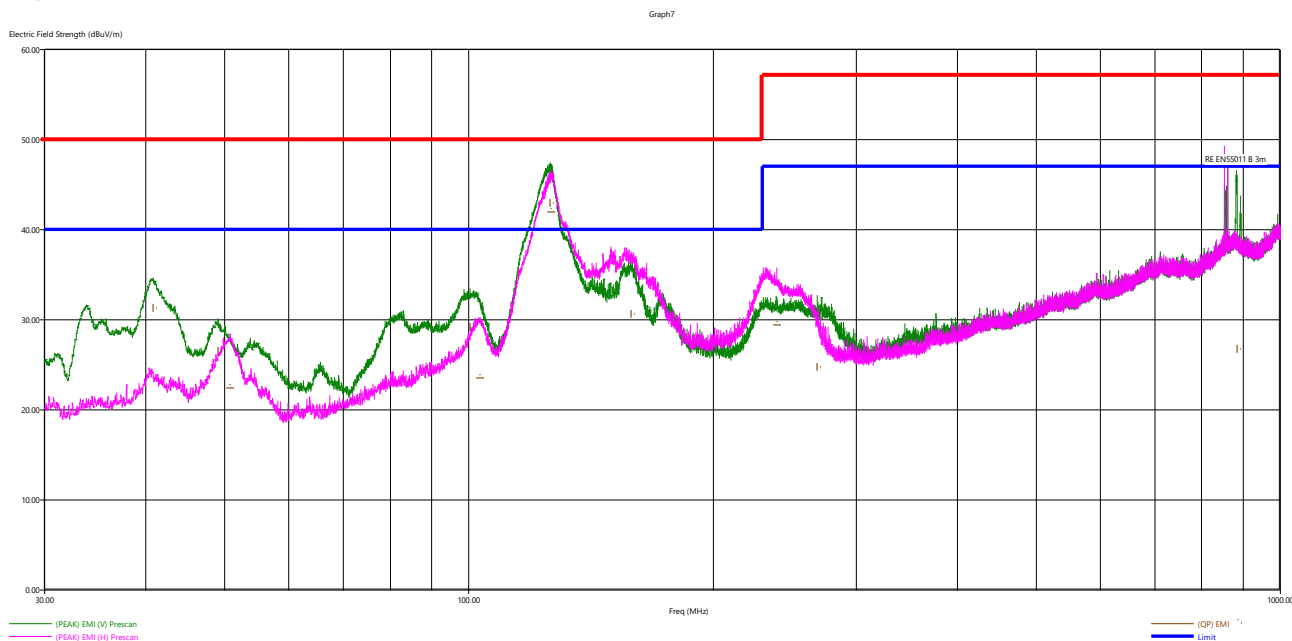

Table 4 - Radiated Electric Field Emissions, DRB120-12-1, 100Vac, 50% Load, EN55011 Stand Alone

Frequency (MHz)	Polarisation	EUT Angle (Degrees)	Tower Height (cm)	Quasi-Peak (dBµV/m)	Limit (dBµV/m)	Margin (dB)
50.79	H	118.0	299	22.33	50.00	27.67
103.23	H	11.5	249	23.43	50.00	26.57
126.15	H	210.5	299	41.86	50.00	8.14
239.70	H	11.5	101	29.35	57.00	27.65
40.80	V	195.5	120	31.16	50.00	18.84
49.08	V	148.1	120	26.47	50.00	23.53
100.38	V	149.5	120	29.11	50.00	20.89
126.06	V	122.5	120	42.83	50.00	7.17
158.04	V	148.9	120	30.50	50.00	19.50
268.71	V	124.0	199	24.72	57.00	32.28
883.29	V	148.9	120	26.62	57.00	30.38

Written by:	Stuart Nottage	Revision	1		
Page	13 of 62	ECR	N/A		
		Date	27/05/2020		

DRB240-48-1 Electromagnetic Compatibility Report 260666

Figure 7 - Test Configuration, Radiated Emissions, In Enclosure,

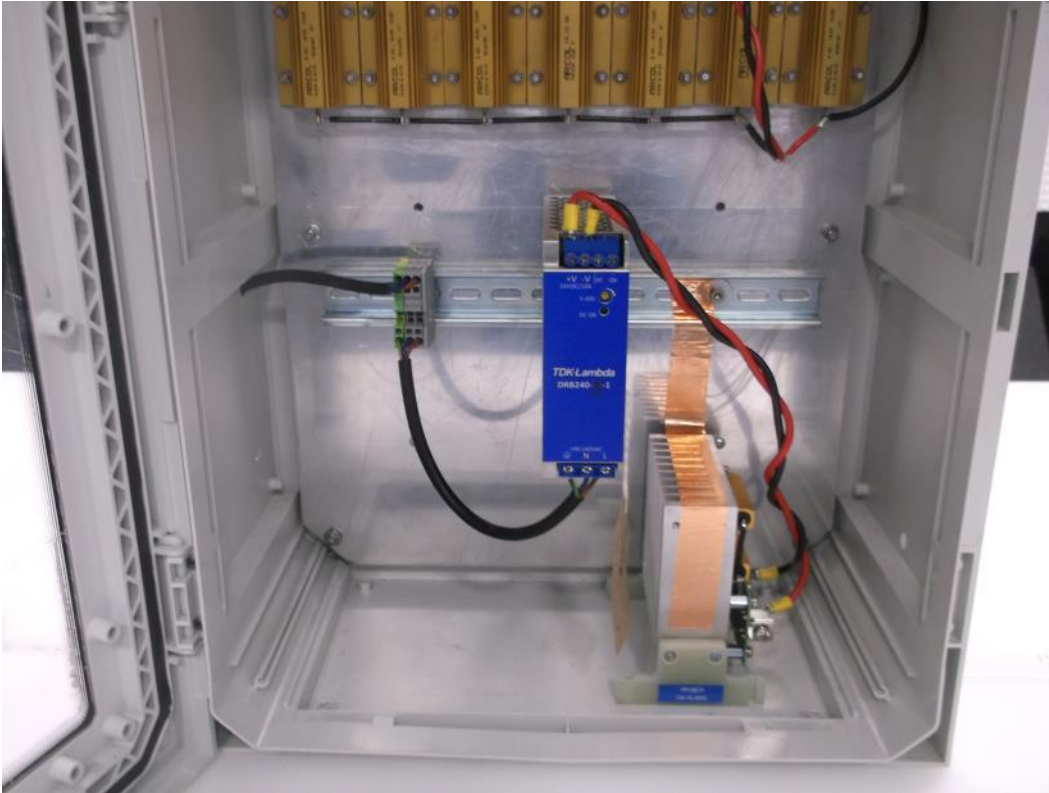

Written by:	Stuart Nottage	Revision	1		
Page	14 of 62	ECR	N/A		
		Date	27/05/2020		

DRB240-48-1 Electromagnetic Compatibility Report 260666

Figure 8 - Radiated Electric Field Emissions, DRB120-12-1, 100Vac, 50% Load, EN55011 In Enclosure

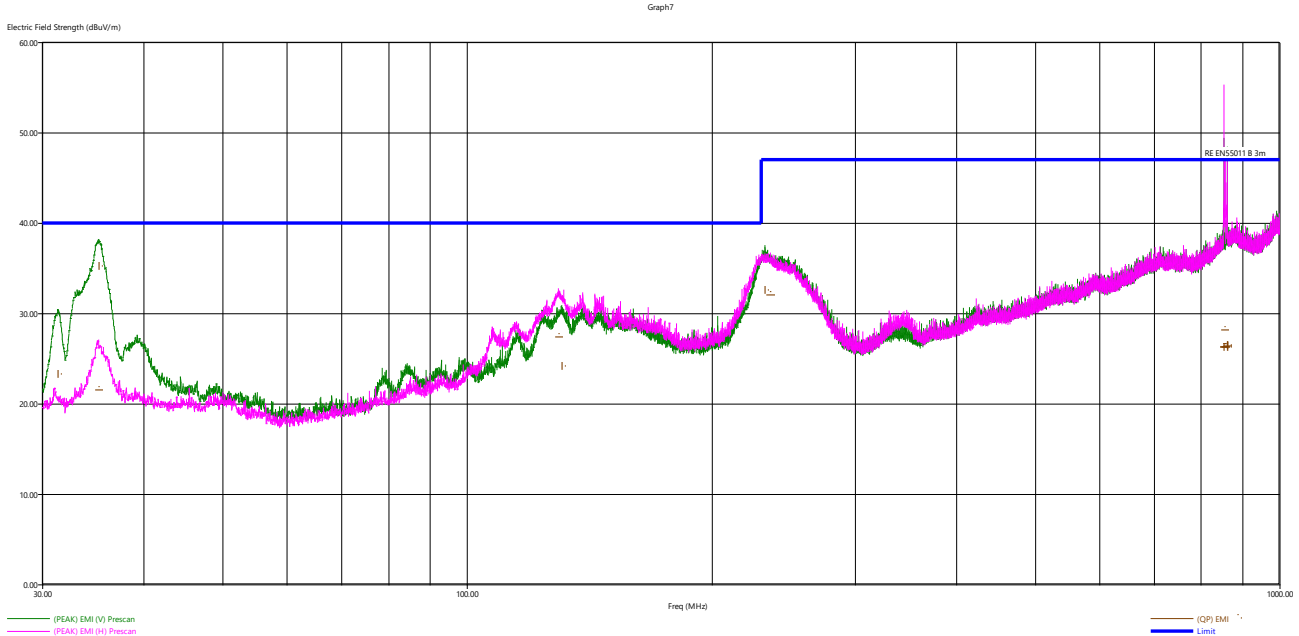

Table 5 - Radiated Electric Field Emissions, DRB120-12-1, 100Vac, 50% Load, EN55011 In Enclosure

Frequency (MHz)	Polarisation	EUT Angle (Degrees)	Tower Height (cm)	Quasi-Peak (dBµV/m)	Limit (dBµV/m)	Margin (dB)
35.16	H	352.9	249	21.53	40.00	18.47
129.42	H	213.5	299	27.33	40.00	12.67
236.07	H	329.4	149	31.98	47.00	15.02
852.60	H	12.5	149	26.30	47.00	20.70
854.85	H	54.0	399	28.12	47.00	18.88
858.30	H	97.5	149	26.24	47.00	20.76
861.39	H	11.4	299	26.35	47.00	20.65
31.29	V	92.6	120	23.28	40.00	16.72
35.19	V	67.5	120	35.13	40.00	4.87
130.71	V	93.9	120	24.11	40.00	15.89
232.50	V	24.6	199	32.54	47.00	14.46
852.51	V	357.0	349	26.25	47.00	20.75
860.97	V	356.0	349	26.27	47.00	20.73
861.33	V	357.5	349	26.44	47.00	20.56

Unit Tested: DRB240-48-1, the EUT met the requirements of EN 55011:2016 +A1:2017 (Class B [Enclosure Port]) for radiated disturbances as well as the requirements of EN 61204-3:2018 (Class A [Enclosure Port]).

Procedure	EN 55011:2016 + A1:2017 EN 61204-3: 2018	Location	TLU EMC Centre
Date(s)	06/12/2019 – 18/05/2020	Test Engineer	Stuart Nottage Glen Moore Nick Heighington

Written by:	Stuart Nottage	Revision	1		
Page	15 of 62	ECR	N/A		
		Date	27/05/2020		

DRB240-48-1 Electromagnetic Compatibility Report 260666

Figure 9 - Test Configuration, Radiated Emissions, EN 61204-3, DRB120-48-1 x2 in Series

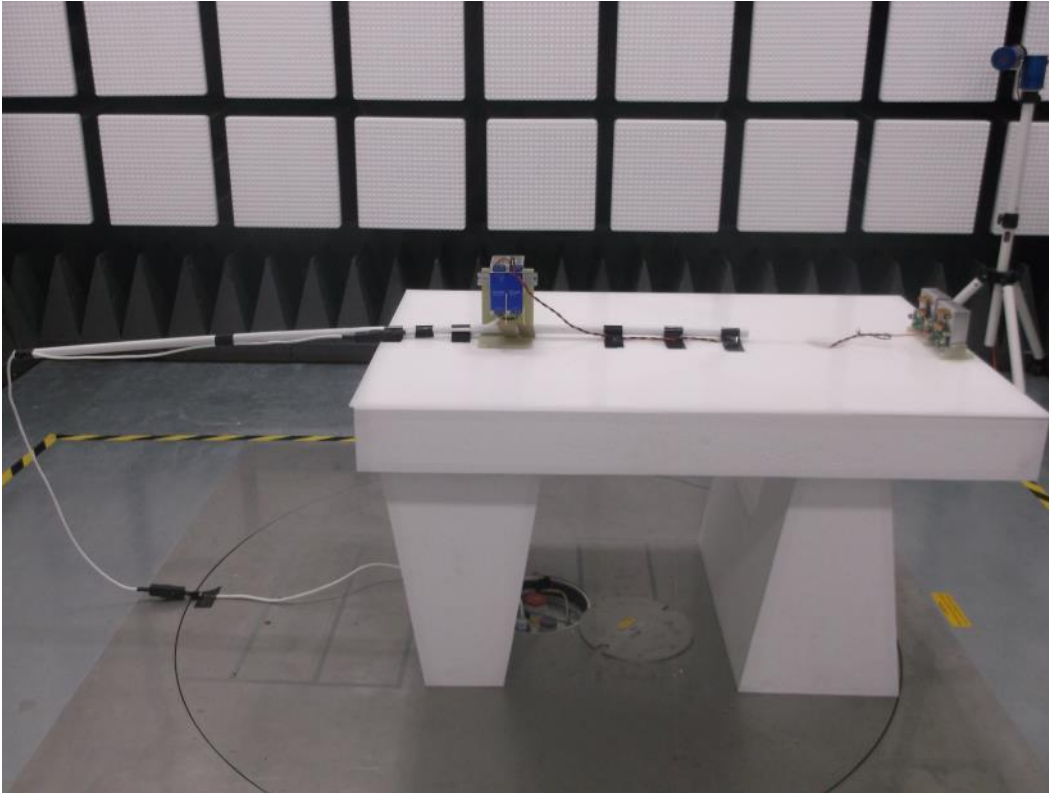

Written by:	Stuart Nottage	Revision	1		
Page	16 of 62	ECR	N/A		
		Date	27/05/2020		

DRB240-48-1 Electromagnetic Compatibility Report 260666

Figure 10 - Radiated Electric Field Emissions, DRB120-48-1 x2 in series, 100Vac, 0% Load, EN61204-3

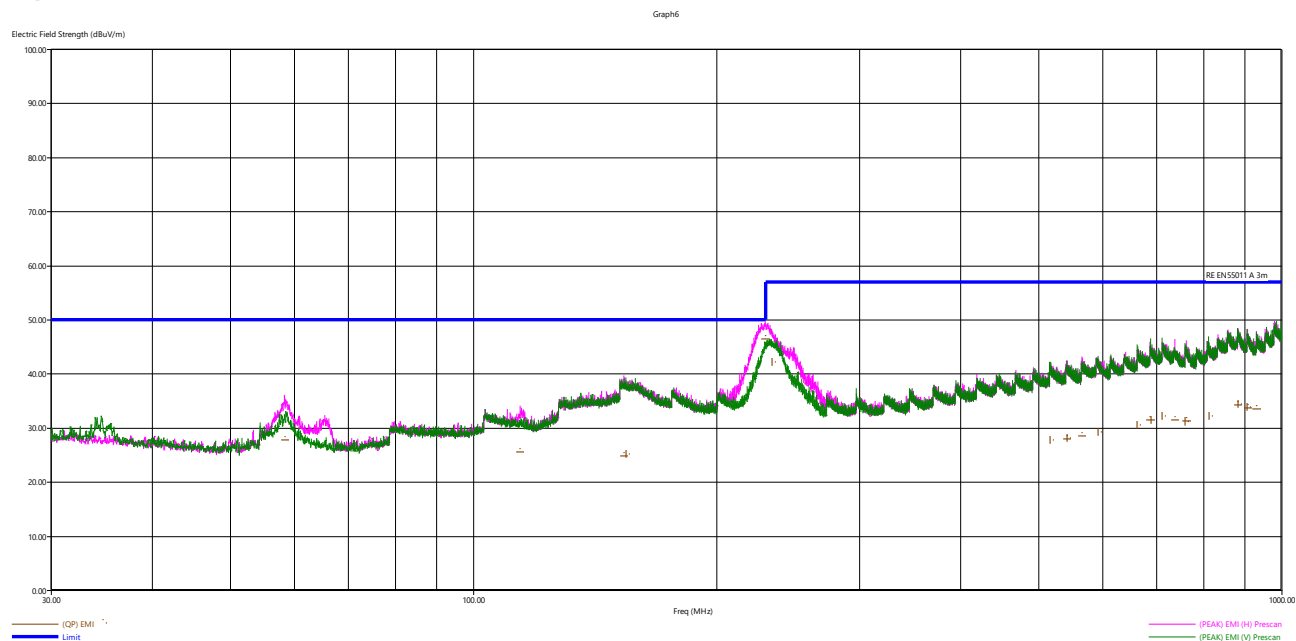

Table 6 - Radiated Electric Field Emissions, DRB120-48-1 x2 in series, 100Vac, 0% Load, EN61204-3

Frequency (MHz)	Polarisation	EUT Angle (Degrees)	Tower Height (cm)	Quasi-Peak (dBµV/m)	Limit (dBµV/m)	Margin (dB)
58.29	H	11.5	200	27.57	50.00	22.43
114.09	H	230.9	151	25.42	50.00	24.58
153.39	H	313.9	151	24.77	50.00	25.23
229.50	H	241.5	151	46.23	50.00	3.77
686.73	H	232.0	349	31.37	57.00	25.63
881.37	H	315.4	399	34.19	57.00	22.81
906.39	H	12.5	151	33.63	57.00	23.37
930.30	H	256.9	399	33.36	57.00	23.64
154.23	V	12.5	121	24.97	50.00	25.03
233.37	V	118.4	151	42.09	57.00	14.91
710.79	V	55.5	349	32.05	57.00	24.95
811.86	V	31.5	121	32.10	57.00	24.90
880.68	V	93.5	349	34.32	57.00	22.68
904.89	V	142.5	299	33.80	57.00	23.20

Written by:	Stuart Nottage	Revision	1		
Page	17 of 62	ECR	N/A		
		Date	27/05/2020		

DRB240-48-1 Electromagnetic Compatibility Report 260666

Figure 11 - Test Configuration, Radiated Emissions, Stand Alone, DRB120-48-1 x2 in series

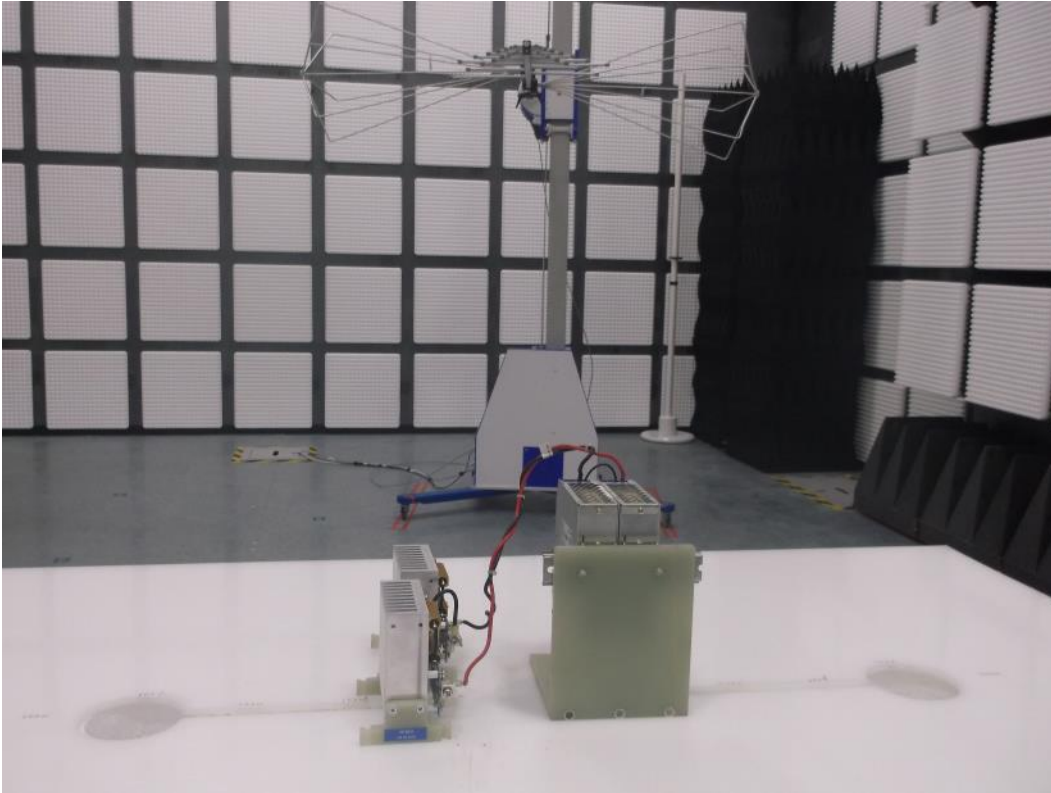

Written by:	Stuart Nottage	Revision	1		
Page	18 of 62	ECR	N/A		
		Date	27/05/2020		

DRB240-48-1 Electromagnetic Compatibility Report 260666

Figure 12 - Radiated Electric Field Emissions, DRB120-48-1 x2 in series, 100Vac, 50% Load, EN55011 Stand Alone

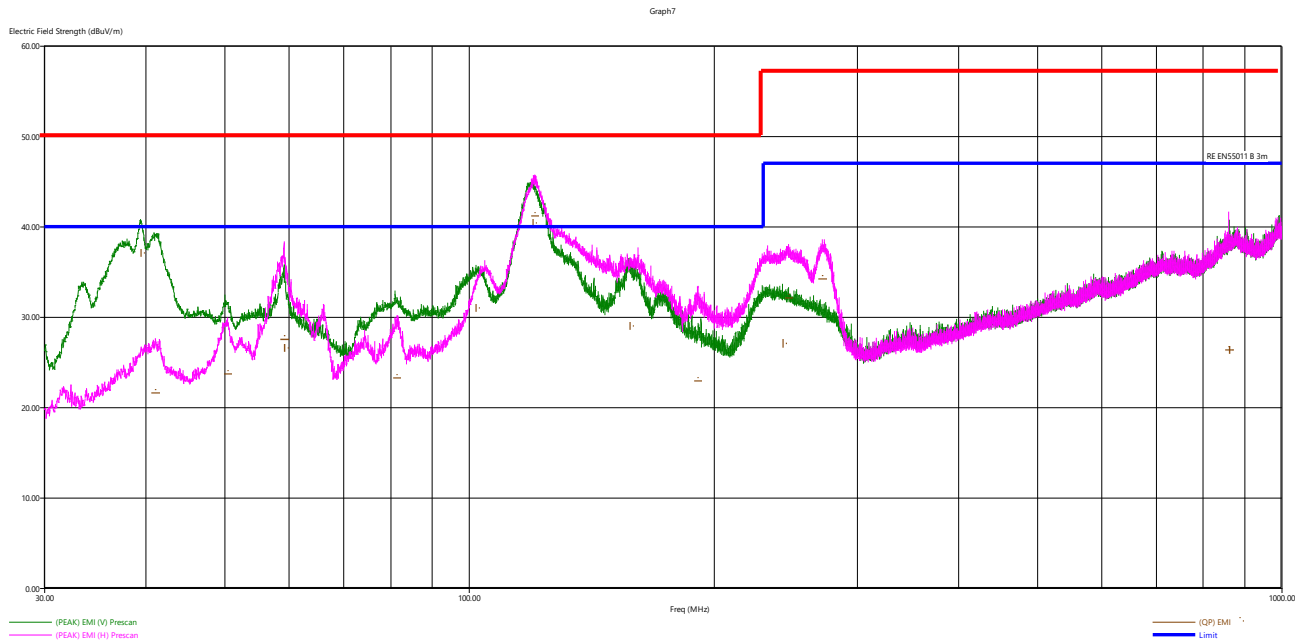

Table 7 - Radiated Electric Field Emissions, DRB120-48-1 x2 in series, 100Vac, 50% Load, EN55011 Stand Alone

Frequency (MHz)	Polarisation	EUT Angle (Degrees)	Tower Height (cm)	Quasi-Peak (dBµV/m)	Limit (dBµV/m)	Margin (dB)
41.07	H	351.9	149	21.50	50.00	28.50
50.37	H	258.5	149	23.65	50.00	26.35
59.16	H	10.5	199	27.46	50.00	22.54
81.51	H	31.1	299	23.17	50.00	26.83
120.21	H	11.5	299	41.14	50.00	8.86
190.98	H	5.1	101	22.85	50.00	27.15
246.81	H	29.5	101	32.08	57.00	24.92
271.65	H	261.4	101	34.16	57.00	22.84
39.36	V	116.4	120	37.02	50.00	12.98
59.13	V	280.9	399	26.50	50.00	23.50
101.88	V	91.6	120	31.00	50.00	19.00
119.61	V	77.6	149	40.36	50.00	9.64
157.62	V	141.0	120	28.98	50.00	21.02
242.67	V	187.4	199	27.04	57.00	29.96

Written by:	Stuart Nottage	Revision	1		
Page	19 of 62	ECR	N/A		
		Date	27/05/2020		

DRB240-48-1 Electromagnetic Compatibility Report 260666

Figure 13 - Test Configuration, Radiated Emissions, In Enclosure, DRB120-48-1 x2 in series

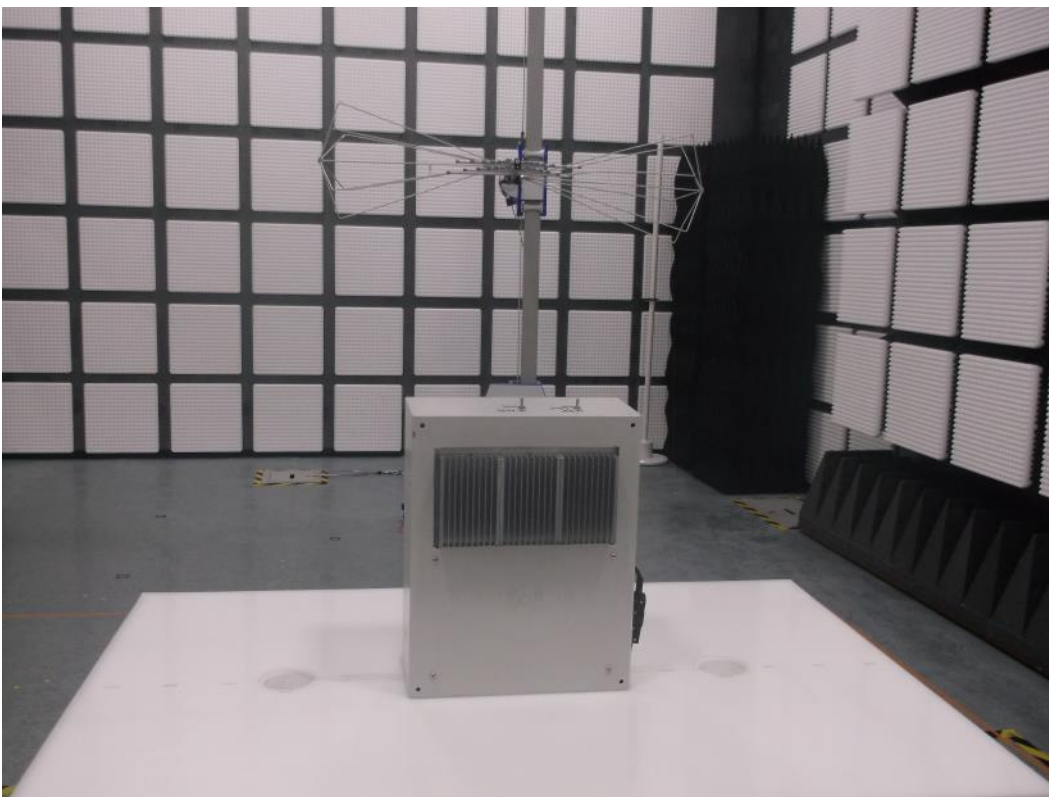

Written by:	Stuart Nottage	Revision	1		
Page	20 of 62	ECR	N/A		
		Date	27/05/2020		

DRB240-48-1 Electromagnetic Compatibility Report 260666

Figure 14 - Radiated Electric Field Emissions, DRB120-48-1 x2 in series, 100Vac, 50% Load, EN55011 In Enclosure

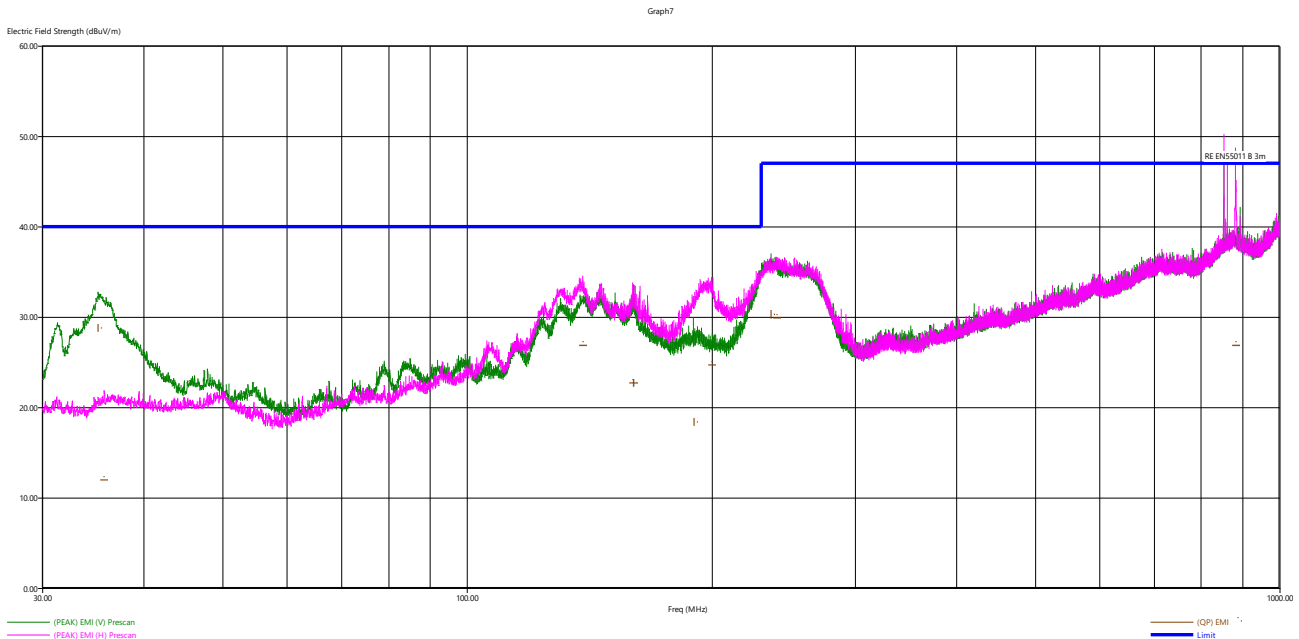

Table 8 - Radiated Electric Field Emissions, DRB120-48-1 x2 in series, 100Vac, 50% Load, EN55011 In Enclosure

Frequency (MHz)	Polarisation	EUT Angle (Degrees)	Tower Height (cm)	Quasi-Peak (dBµV/m)	Limit (dBµV/m)	Margin (dB)
35.73	H	11.5	249	11.87	40.00	28.13
138.69	H	215.4	199	26.78	40.00	13.22
159.60	H	96.6	149	22.64	40.00	17.36
199.65	H	6.5	101	24.59	40.00	15.41
240.18	H	328.5	101	29.84	47.00	17.16
881.40	H	30.2	199	26.76	47.00	20.24
35.10	V	137.5	120	28.74	40.00	11.26
160.11	V	159.9	120	22.65	40.00	17.35
189.60	V	158.5	120	18.35	40.00	21.65
236.55	V	24.5	199	30.21	47.00	16.79

Unit Tested: DRB120-48-1 x2 in series, the EUT met the requirements of EN 55011:2016 +A1:2017 (Class B [Enclosure Port]) for radiated disturbances as well as the requirements of EN 61204-3:2018 (Class A [Enclosure Port]).

Procedure	EN 55011:2016 + A1:2017 EN 61204-3: 2018	Location	TLU EMC Centre
Date(s)	05/11/2019 – 11/12/2019	Test Engineer	Paul Dyer Glen Moore

Written by:	Stuart Nottage	Revision	1		
Page	21 of 62	ECR	N/A		
		Date	27/05/2020		

DRB240-48-1 Electromagnetic Compatibility Report 260666

Table 9 - Radiated Emissions Test Equipment

Equipment	Serial Number	Calibration	Performance Verified	
		Date Expires	Date	By
Rohde & Schwarz ESR (16)	1316.3003K03-102515-KU	02/01/2021	11/05/2020	Stuart Nottage
Schwarzbeck-Mess VULB 9166	1096	09/06/2020	11/05/2020	Stuart Nottage
Maturo Control Unit MCU	599	N/A	11/05/2020	Stuart Nottage
Maturo Antenna Mast AM 4.0	774	N/A	11/05/2020	Stuart Nottage
Maturo Turntable TT 2.0 SI	296	N/A	11/05/2020	Stuart Nottage
TRS 3m Semi-Anechoic Chamber	N/A	07/01/2022	11/05/2020	Stuart Nottage
Cable	EMI-RF-1	03/05/2021	11/05/2020	Stuart Nottage
Cable	EMI-RF-2	03/05/2021	11/05/2020	Stuart Nottage
Cable	EMI-RF-3	03/05/2021	11/05/2020	Stuart Nottage
Cable	EMI-RF-8	03/05/2021	11/05/2020	Stuart Nottage
Chase CEC-8110 used as a CMAD	271	N/A	15/05/2020	Stuart Nottage

Written by:	Stuart Nottage	Revision	1		
Page	22 of 62	ECR	N/A		
		Date	27/05/2020		

7. Conducted Emissions, Mains Disturbance 0.15MHz to 30MHz to EN55011

7.1.AC Power Port - Test Procedure

The test was performed according to the specification. The emissions were measured using an Average and a Quasi-Peak detector. A full scan was taken from 0.15 MHz to measuring both L1 and N lines. In accordance with EN55011 the emissions were measured at full, half and minimum (zero) load, at both high and low input line.

Figure 15 - Conducted Emissions Test Setup

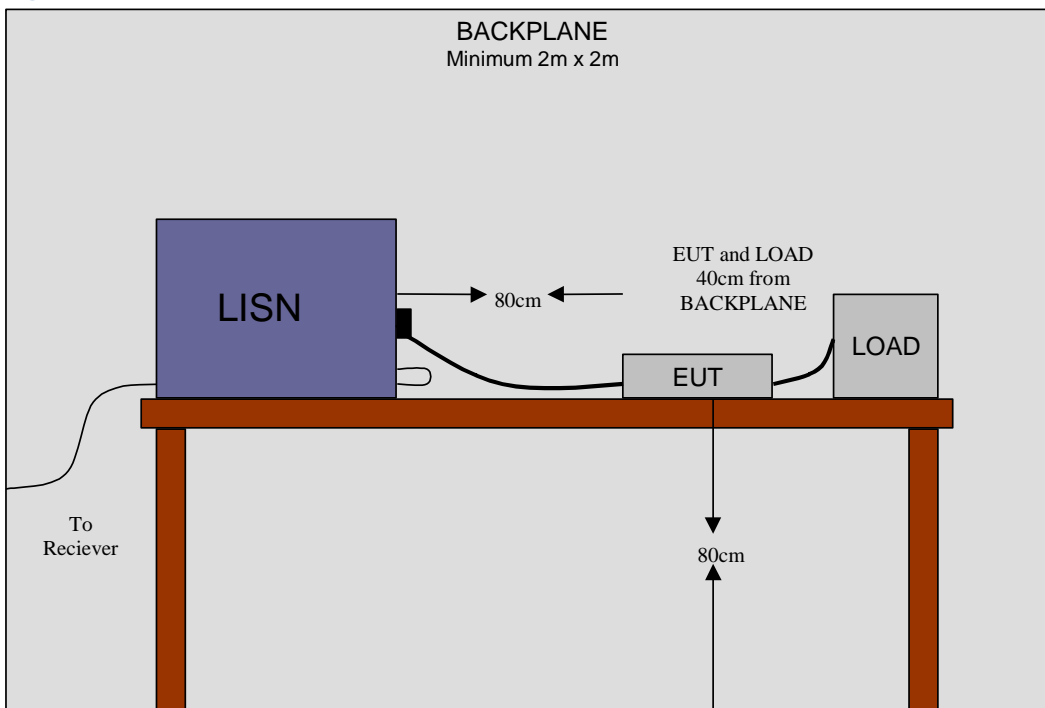

Written by:	Stuart Nottage	Revision	1		
Page	23 of 62	ECR	N/A		
		Date	27/05/2020		

DRB240-48-1 Electromagnetic Compatibility Report 260666

Figure 16 - Conducted Emissions Test Setup, DRB240-48-1



Written by:	Stuart Nottage	Revision	1		
Page	24 of 62	ECR	N/A		
		Date	27/05/2020		

7.2. AC Power Port - Test Results

Figure 17 - Conducted Emissions 230Vac, DRB240-48-1, Full Load, Graph

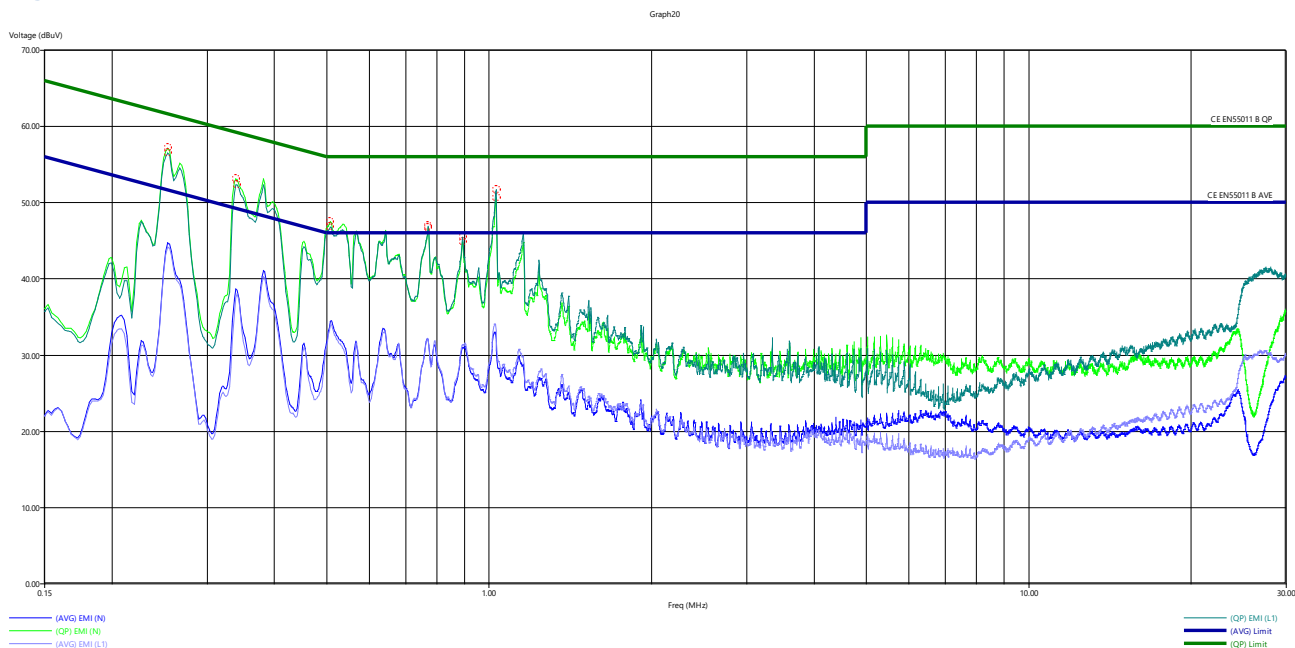

Table 10 - Conducted Emissions 230Vac DRB240-48-1, Full Load

Frequency (MHz)	Average (dBµV)	Limit (dBµV)	Margin (dB)	Quasi-Peak (dBµV)	Limit (dBµV)	Margin (dB)
0.25	44.72	51.64	6.92	57.18	61.64	4.46
0.34	38.66	49.23	10.57	53.17	59.23	6.06
0.34	38.55	49.17	10.62	53.09	59.17	6.08
0.51	34.38	46.00	11.62	47.49	56.00	8.51
0.77	31.99	46.00	14.01	46.88	56.00	9.12
0.89	31.42	46.00	14.58	45.46	56.00	10.54
1.03	33.11	46.00	12.89	51.75	56.00	4.25

Written by:	Stuart Nottage	Revision	1		
Page	25 of 62	ECR	N/A		
		Date	27/05/2020		

DRB240-48-1 Electromagnetic Compatibility Report 260666

Figure 18 - Conducted Emissions 230Vac, DRB240-48-1, Half Load, Graph

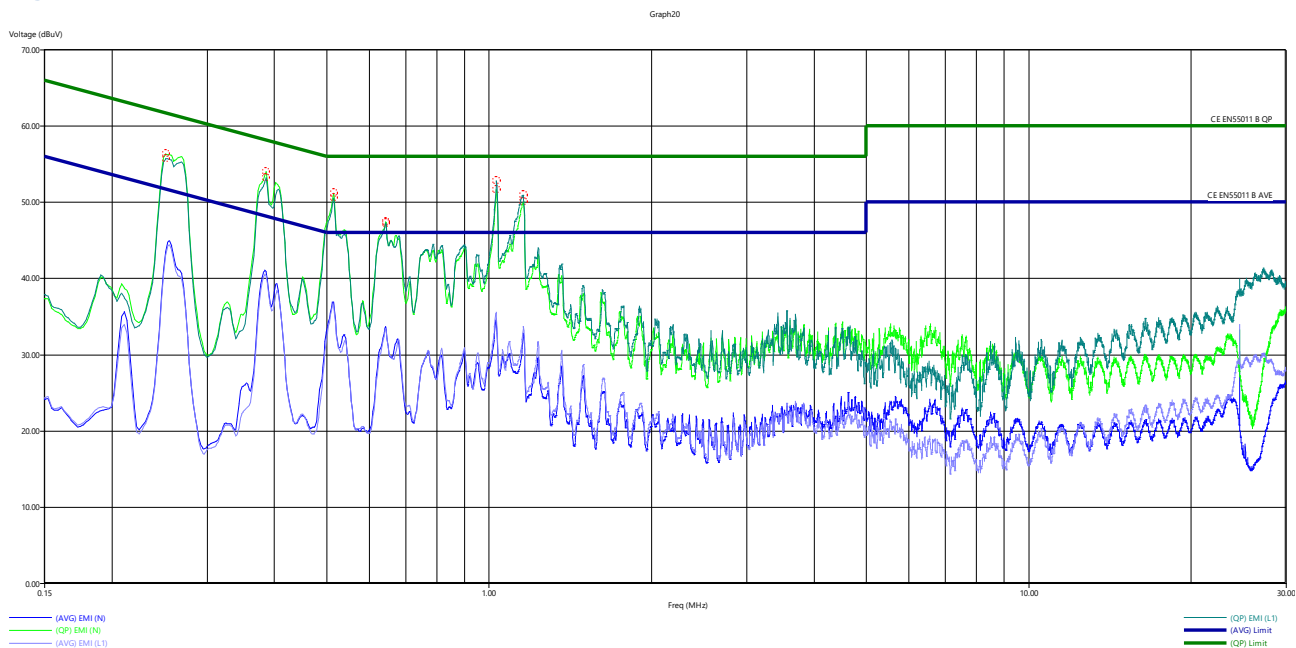

Table 11 - Conducted Emissions 230Vac DRB240-48-1, Half Load

Frequency (MHz)	Average (dBµV)	Limit (dBµV)	Margin (dB)	Quasi-Peak (dBµV)	Limit (dBµV)	Margin (dB)
0.25	43.47	51.72	8.25	56.33	61.72	5.39
0.39	40.83	48.14	7.31	54.07	58.14	4.07
0.51	36.95	46.00	9.05	51.20	56.00	4.80
0.64	33.72	46.00	12.28	47.47	56.00	8.53
1.03	34.99	46.00	11.01	52.82	56.00	3.18
1.16	33.42	46.00	12.58	50.92	56.00	5.08

Written by:	Stuart Nottage	Revision	1		
Page	26 of 62	ECR	N/A		
		Date	27/05/2020		

DRB240-48-1 Electromagnetic Compatibility Report 260666

Figure 19 - Conducted Emissions 230Vac, DRB240-48-1, Zero Load, Graph

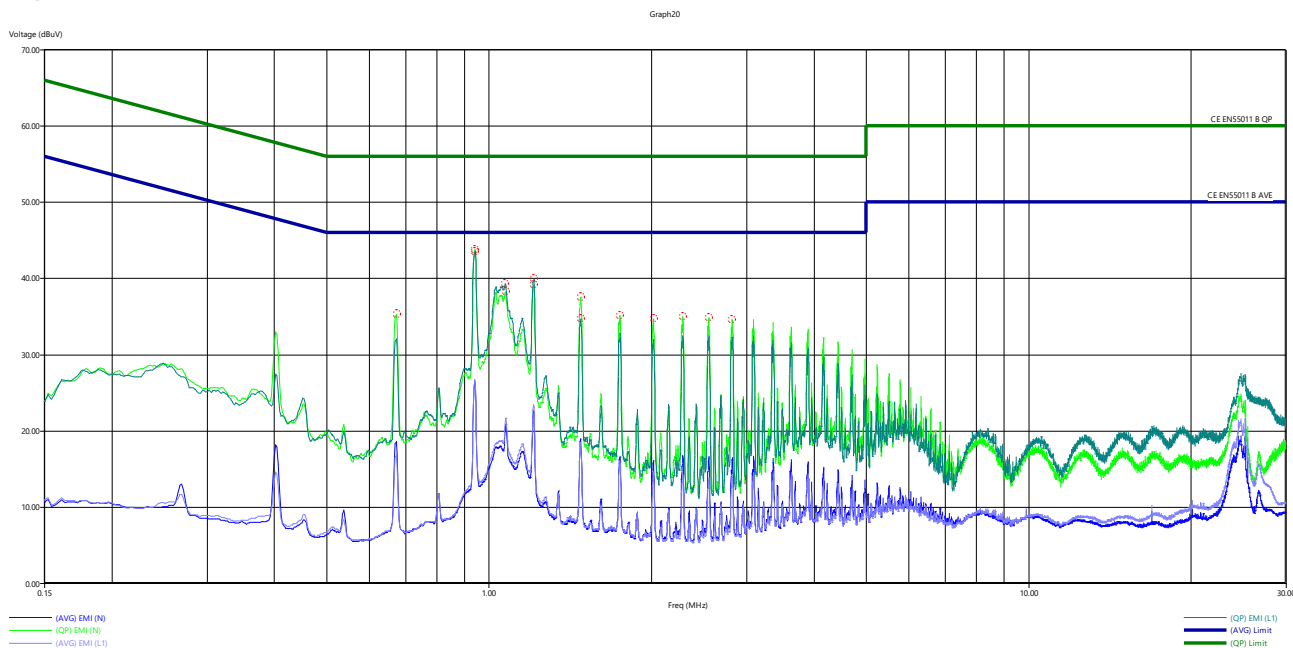

Table 12 - Conducted Emissions 230Vac DRB240-48-1, Zero Load

Frequency (MHz)	Average (dBµV)	Limit (dBµV)	Margin (dB)	Quasi-Peak (dBµV)	Limit (dBµV)	Margin (dB)
0.67	18.61	46.00	27.39	35.27	56.00	20.73
0.94	26.73	46.00	19.27	43.79	56.00	12.21
1.07	21.00	46.00	25.00	39.31	56.00	16.69
1.07	21.69	46.00	24.31	39.19	56.00	16.81
1.21	23.11	46.00	22.89	39.92	56.00	16.08
1.48	19.03	46.00	26.97	37.58	56.00	18.42
1.75	16.62	46.00	29.38	35.13	56.00	20.87
2.02	16.11	46.00	29.89	34.69	56.00	21.31
2.29	16.74	46.00	29.26	34.98	56.00	21.02
2.55	16.55	46.00	29.45	34.87	56.00	21.13
2.82	16.21	46.00	29.79	34.60	56.00	21.40

Written by:	Stuart Nottage	Revision	1		
Page	27 of 62	ECR	N/A		
		Date	27/05/2020		

DRB240-48-1 Electromagnetic Compatibility Report 260666

Figure 20 - Conducted Emissions 100Vac, DRB240-48-1, Full Load, Graph

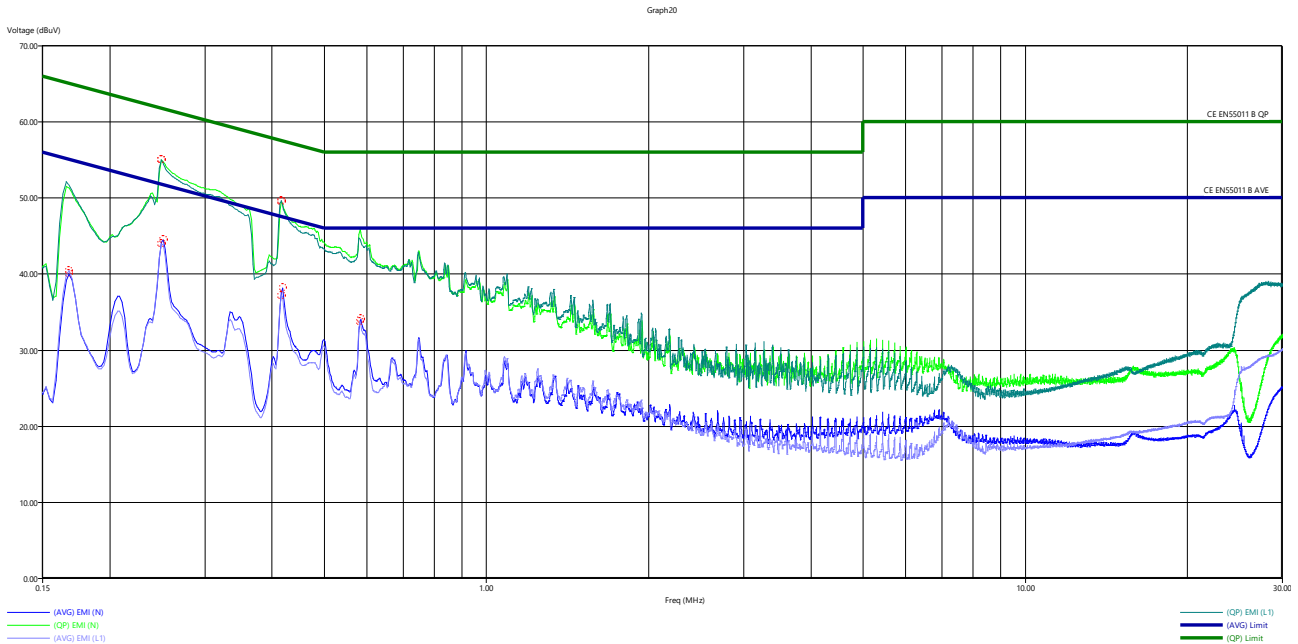

Table 13 - Conducted Emissions 100Vac, DRB240-48-1, Full Load

Frequency (MHz)	Average (dBµV)	Limit (dBµV)	Margin (dB)	Quasi-Peak (dBµV)	Limit (dBµV)	Margin (dB)
0.17	40.49	55.06	14.57	51.69	65.06	13.37
0.25	44.15	51.79	7.64	55.00	61.79	6.79
0.25	44.49	51.72	7.23	54.74	61.72	6.98
0.42	37.65	47.54	9.89	49.65	57.54	7.89
0.42	38.12	47.49	9.37	49.14	57.49	8.35
0.58	33.90	46.00	12.10	45.89	56.00	10.11
0.58	34.07	46.00	11.93	45.39	56.00	10.61

Unit Tested: DRB240-48-1, the EUT met the requirements of EN 55011:2016 +A1:2017 (Class B [Enclosure Port]) for conducted disturbances.

Procedure	EN 55011:2016 + A1:2017	Date	26/11/2019
		Test Location	TDK-Lambda UK Ltd
Environment	22°C; 49% rh; 981hPa	Test Engineer	Glen Moore

Table 14 - Conducted Emissions Test Equipment.

Equipment	Serial Number	Calibration	Performance Verified	
		Date Expires	Date	By
Rohde & Schwarz ESR (17)	1316.3003K03-102441-tM	02/06/2020	22/01/2020	Paul Dyer
Rohde & Schwarz ESH3-Z5	831.5518.52	09/06/2020	22/01/2020	Paul Dyer
Rohde & Schwarz ESH3-Z2	357.8810.52	26/06/2020	22/01/2020	Paul Dyer
Cable	EMI-RF-5	N/A	22/01/2020	Paul Dyer
Cable	EMI-RF-6	N/A	22/01/2020	Paul Dyer

Written by:	Stuart Nottage	Revision	1		
		ECR	N/A		
		Date	27/05/2020		
Page	28 of 62				

8. Conducted Emissions On Power Lines (Harmonics) to EN61000-3-2

8.1. AC Power Port - Test Procedure

The test was performed according to the specification. The mains supply was generated by an AC Power Source, this provides a 50 or 60 Hz supply whose harmonic content is very low over the frequency range of the test. The odd and even harmonics were then measured from the fundamental, 50 / 60Hz, to the 40th harmonic, with the EUT on and functioning correctly. The harmonic emission profile emanating from the EUT was measured and this was then compared to the requirements of the specification.

8.2. AC Power Port - Test Results

The details of the test results are given below.

Table 15 – Harmonics, DRB240-48-1, Class A

Harmonic No.	Average Value (A)	Class A Limit (A)	Harmonic No.	Average Value (A)	Class A Limit (A)	Harmonic No.	Average Value (A)	Class A Limit (A)	Harmonic No.	Average Value (A)	Class A Limit (A)
1	1.143	-	11	0.020	0.330	21	0.005	0.107	31	0.005	0.073
2	0.003	1.080	12	0.001	0.153	22	0.001	0.084	32	0.001	0.058
3	0.329	2.300	13	0.012	0.210	23	0.009	0.098	33	0.006	0.068
4	0.001	0.430	14	0.001	0.131	24	0.001	0.077	34	0.003	0.054
5	0.048	1.140	15	0.011	0.150	25	0.008	0.090	35	0.004	0.064
6	0.001	0.300	16	0.001	0.115	26	0.001	0.071	36	0.001	0.051
7	0.040	0.770	17	0.004	0.132	27	0.004	0.083	37	0.008	0.061
8	0.001	0.230	18	0.001	0.102	28	0.001	0.066	38	0.001	0.048
9	0.033	0.400	19	0.013	0.118	29	0.005	0.078	39	0.003	0.058
10	0.001	0.184	20	0.001	0.092	30	0.001	0.061	40	0.001	0.046

Figure 21 - Harmonics, DRB240-48-1, Class A. Graph

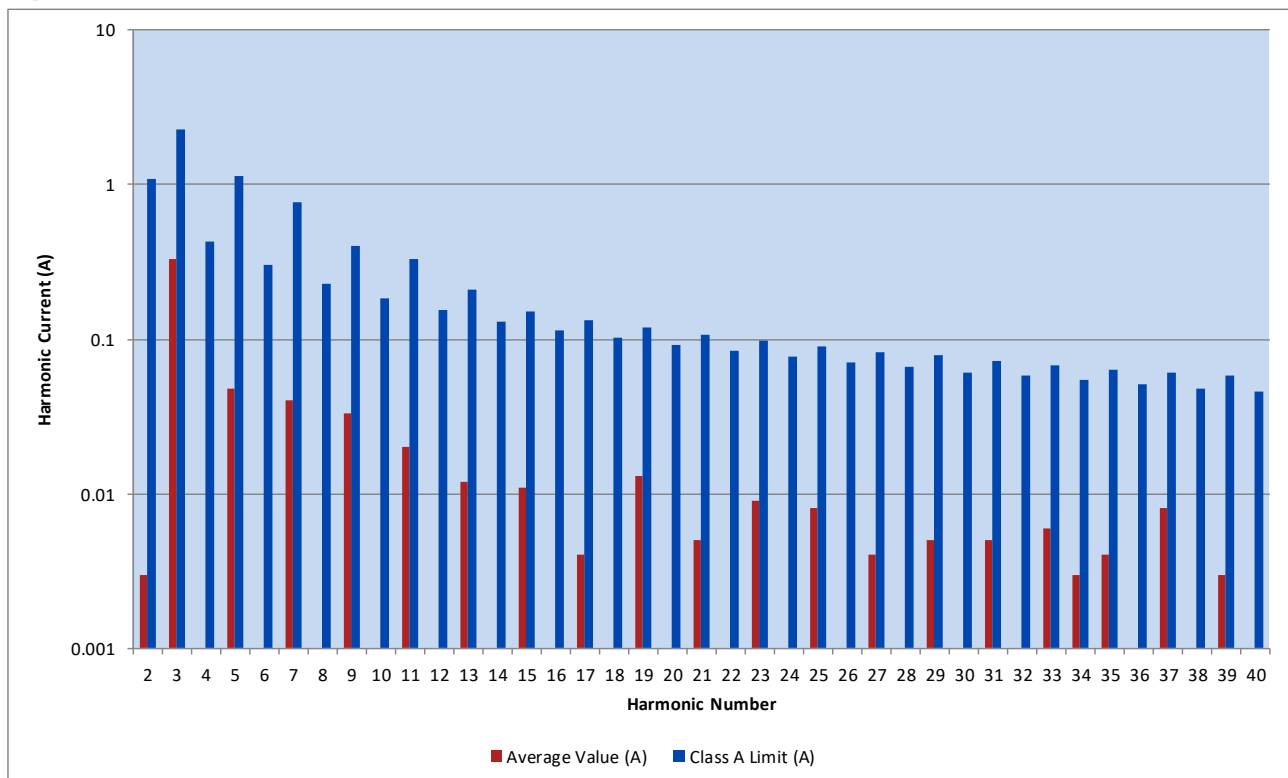

Written by:	Stuart Nottage	Revision	1	
Page	29 of 62	ECR	N/A	
		Date	27/05/2020	

DRB240-48-1 Electromagnetic Compatibility Report 260666

EUT: DRB240-48-1, met the requirements of EN 61000-3-2:2014, for Class A Harmonic current emissions.

Procedure	EN61000-3-2:2014	Date	16/12/2019
Environment	25°C	Test Location	TDK-Lambda UK Ltd.
		Test Engineer	Nick Heighington

Table 16 - Conducted Harmonics, Test Equipment

Equipment	Serial	Calibration
Montford Chamber	6616	04/02/2020
Chroma AC Source 61505	863	15/01/2021
Vitre Power Analyser PA900	26950	28/10/2020
Chroma Load Mainframe 1 6334A	2710	N/A
Chroma Load Mainframe 2 6334A	2731	N/A
Rohde & Schwarz Scope RTM3004	102988	10/10/2020
Agilent Current Probe 1 1146B	4526	03/09/2020
Agilent Current Probe 2 1146B	2872	09/04/2020
Keysight Differential Probe N2791A	PH57260029	02/02/2021
Dell PC OPTIPLEX 3020	98WQ992	N/A
Chroma Load Module 63306A	867	08/10/2020
Chroma Load Module 63303A	6788	08/04/2020
Chroma Load Module 63303A	18445	06/04/2020
Chroma Load Module 63305A	440	08/10/2020

Written by:	Stuart Nottage	Revision	1		
Page	30 of 62	ECR	N/A		
		Date	27/05/2020		

9. Limitation of Voltage Changes, Fluctuations & Flicker to EN61000-3-3

9.1. AC Power Port - Test Procedure

The main part of the Flicker test, is not performed as it is only relevant in the end application, so is the responsibility of the manufacturer of the end equipment to test P_{st} and P_{lt} . The part of the standard that is applicable to a power supply is the measurement of d_{max} in Annex B. The test was performed according to the specification. The 50 Hz mains supply was generated by an AC Power Source. The EUT is set up and operated under full loading to give maximum input current, an oscilloscope is connected to measure input current and voltage waveforms. Twenty-four (24) measurements of inrush current are taken at one-minute intervals, measuring the maximum r.m.s. input current evaluated over each 10ms half-period between zero voltage crossings. The minimum and maximum values are discarded and the arithmetical average of the remainder is taken. The voltage deviation is calculated as follows:

$$dV = I_{rms} \times (R_a + jX_a + R_n + jX_n)$$

The limit is 4% voltage change, which at 230Vac is 9.2V.

9.2. Test Results

Table 17 - Flicker Test Results, DRB240-48-1

Number	Voltage (V)	Number	Voltage (V)	Number	Voltage (V)	Number	Voltage (V)
1	5.2	7	4.1	13	5.4	19	5.1
2	5.7	8	5.3	14	4.9	20	5.7
3	5.9	9	4.4	15	5.2	21	4.8
4	4.2	10	4.2	16	4.3	22	3.7
5	4.2	11	4.2	17	5.1	23	4.3
6	4.8	12	5.4	18	5.3	24	4.6

Average voltage change $d_{max} = 4.8\text{Volts}$, or 2.1%.

EUT: DRB240-48-1, met the requirements of EN 61000-3-3:2008, for Voltage Changes, Fluctuations & Flicker for $d_{max} < 4\%$.

Procedure	EN 61000-3-3:2013	Date	18/12/2019
Environment	22°C	Test Location	TDK-Lambda UK Ltd.
		Test Engineer	Nick Heighington

Table 18 - Flicker Test Equipment

Name	Serial Number	Calibration Expires
Chroma 61505 AC Source	A476	10/04/2020
Oscilloscope	A397	07/10/2020
Electronic Load	A432	10/04/2020
Differential Probe	A504	14/01/2020
Current Probe	A494	14/01/2020

Written by:	Stuart Nottage	Revision	1		
Page	31 of 62	ECR	N/A		
		Date	27/05/2020		

10. Immunity to Electrostatic Discharge to EN61000-4-2

10.1. Test Procedure

The test was performed according to the specification. The EUT was set up on insulators 0.5 mm above the Horizontal coupling plane and tested in accordance with the specification. The unit was tested while operational at 230Vac, full load, and when non-operational.

Figure 22 - ESD Test Setup Diagram

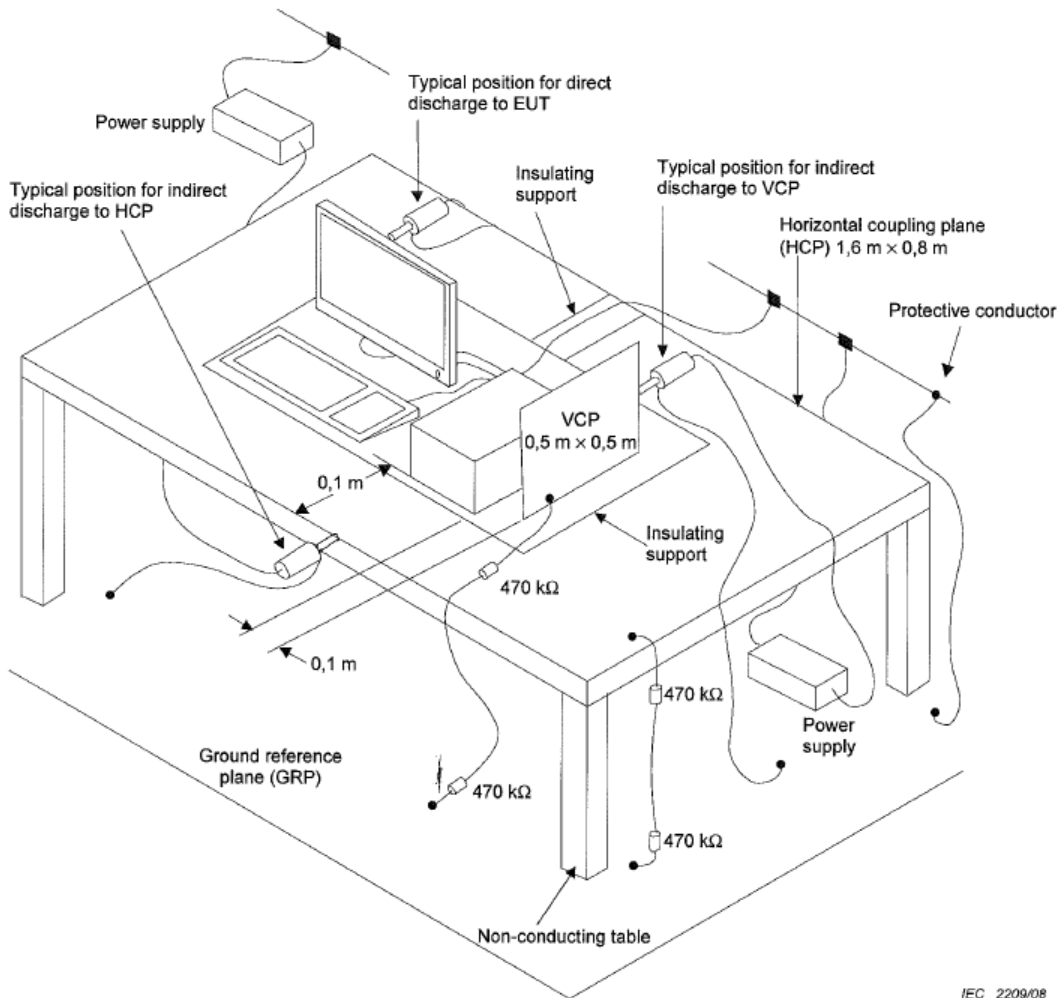

IEC 2209/08

Written by:	Stuart Nottage	Revision	1		
Page	32 of 62	ECR	N/A		
		Date	27/05/2020		

10.2. Air Discharge

A potential was applied to each applicable test point, the levels are given in Table 19 below. Where the discharges occurred the potential was then applied a total of 20 times to each test point, ten positive and ten negative discharges.

Table 19 - ESD, Test Levels, Air Discharge

Level	Voltage
1	2 kV
2	4 kV
3	8 kV
4	15 kV

Table 20 - ESD, Test Points, Air Discharge

Air Discharge	Specification Level
None Applicable	N/A

10.3. Contact Discharge

All user accessible conductive surfaces (Test Points) were subjected to contact discharges, the levels are given in Table 21 below, ten positive and ten negative discharges were applied, alternating the polarity between subsequent discharges. The side of the EUT was subjected to Vertical Coupled Plane (VCP) discharges and the base of the EUT was subjected to Horizontal Coupled Plane (HCP) discharges, ten positive and ten negative. Correct functioning of the EUT throughout the test was checked by using the procedures described in Section 4.2.

Table 21 - ESD, Test Levels, Contact Discharge

Level	Voltage
1	2 kV
2	4 kV
3	6 kV
4	8 kV

Table 22 - ESD, Test Points, Contact Discharge

Contact Discharge	Specification Level
Horizontal Coupling Plane	3
Vertical Coupling Plane	3
Bottom of Case	3
Left of Case	3
Right of Case	3
Top of Case	3
Mains Input Port ⁴	3
DC Output Port	3
Power Good Signal Port	3

⁴ Input connections are only tested with the unit switched off.

Written by:	Stuart Nottage	Revision	1		
Page	33 of 62	ECR	N/A		
		Date	27/05/2020		

DRB240-48-1 Electromagnetic Compatibility Report 260666

10.4. ESD, Test Results

Table 23 - ESD Test Results, DRB240-48-1

Discharge	Voltage	Level	Test Point	Spec Criteria	Result Criteria	Pass / Fail
Contact	6000V	3	Horizontal Coupling Plane	A	A	PASS
Contact	6000V	3	Vertical Coupling Plane	A	A	PASS
Contact	6000V	3	Top of Case	A	A	PASS
Contact	6000V	3	Bottom of Case	A	A	PASS
Contact	6000V	3	Left of Case	A	A	PASS
Contact	6000V	3	Right of Case	A	A	PASS
Contact	6000V	3	Fan Grill	A	A	PASS
Contact	6000V	3	Input Port [Unit off]	A	A	PASS
Contact	6000V	3	DC Power Port	A	A	PASS
Contact	6000V	3	DC Good Signal Port	A	A	PASS

Figure 23 - ESD, Test Setup Photographs, DRB240-48-1

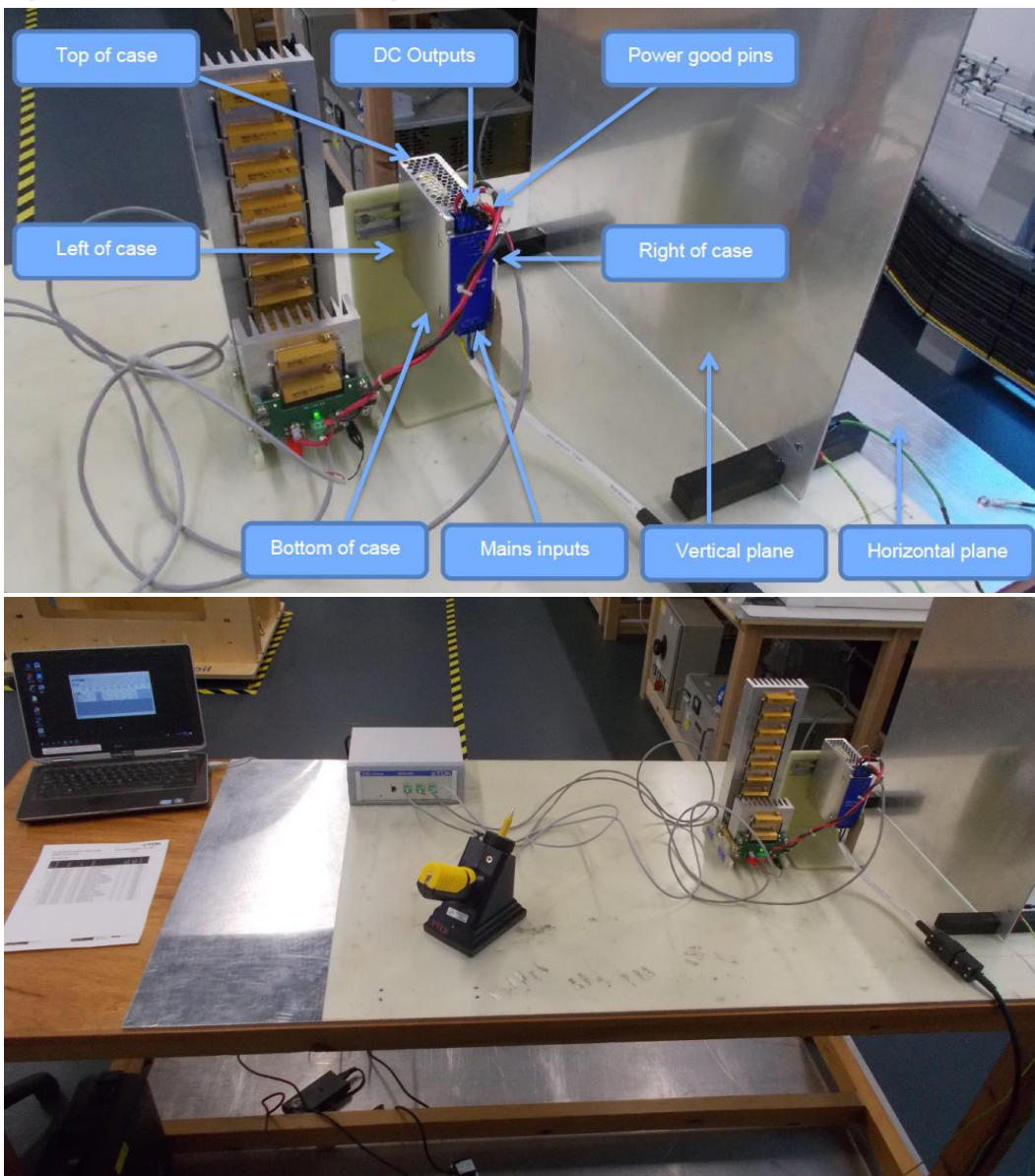

Written by:	Stuart Nottage	Revision	1		
Page	34 of 62	ECR	N/A		
		Date	27/05/2020		

DRB240-48-1 Electromagnetic Compatibility Report 260666

Unit tested: DRB240-48-1, the EUT met the requirements of EN 61000-4-2:2009 (level 3, [Enclosure Port, DC Power, Signal and AC Input Port]) for immunity to electrostatic discharge. The EUT's performance level met Criteria A, as defined in Appendix A. Details of points tested are presented above.

Procedure	EN 61000-4-2:2009	Date	16/11/2019
		Test Location	TDK-Lambda UK Ltd.
Environment	20°C; 39%rh; 1001mB	Test Engineer	Paul Dyer

Table 24 - ESD Test Equipment

Name	Manufacturer	Serial Number	Calibration
ESD Simulation System, NSG435	Schaffner	165	05/06/2020
Glitch Detector	TDK-Lambda UK	MOGD01	N/A
Resistive Load 48V@4A	TDK-Lambda UK	RL4822	N/A
Resistive Load 48V@1A	TDK-Lambda UK	RL4811	N/A

The ESD test equipment was verified according to the standard prior to the testing.

Written by:	Stuart Nottage	Revision	1		
Page	35 of 62	ECR	N/A		
		Date	27/05/2020		

11. Immunity to Radiated Electric Fields to EN61000-4-3

11.1. Enclosure Port Continuous Swept Field

The EUT was tested in accordance with EN61000-4-3, all testing was conducted within a anechoic chamber. The test levels are given below.

Table 25 - Radiated Electric Field Immunity, Test levels

Level	Field Strength
1	1Vm ⁻¹
2	3Vm ⁻¹
3	10Vm ⁻¹
4	30Vm ⁻¹

The EUT was subjected to the specified field strength over the frequency ranges 80 MHz to 6.0 GHz in both horizontal and vertical polarisation. Due to the small size of the unit, only two orthogonal faces of the EUT were tested. The frequency was stepped by increasing the present frequency by 1%, and the dwell time at each frequency step was 0.5 seconds. The carrier frequency was amplitude modulated with a 1kHz sine wave at a modulation depth of 80%. The field strength level given is of the unmodulated carrier signal. Correct functioning of the EUT throughout the test was checked using the procedures described in section 4.2.

Figure 24 - Radiated Electric Field Immunity, Test Setup Diagram

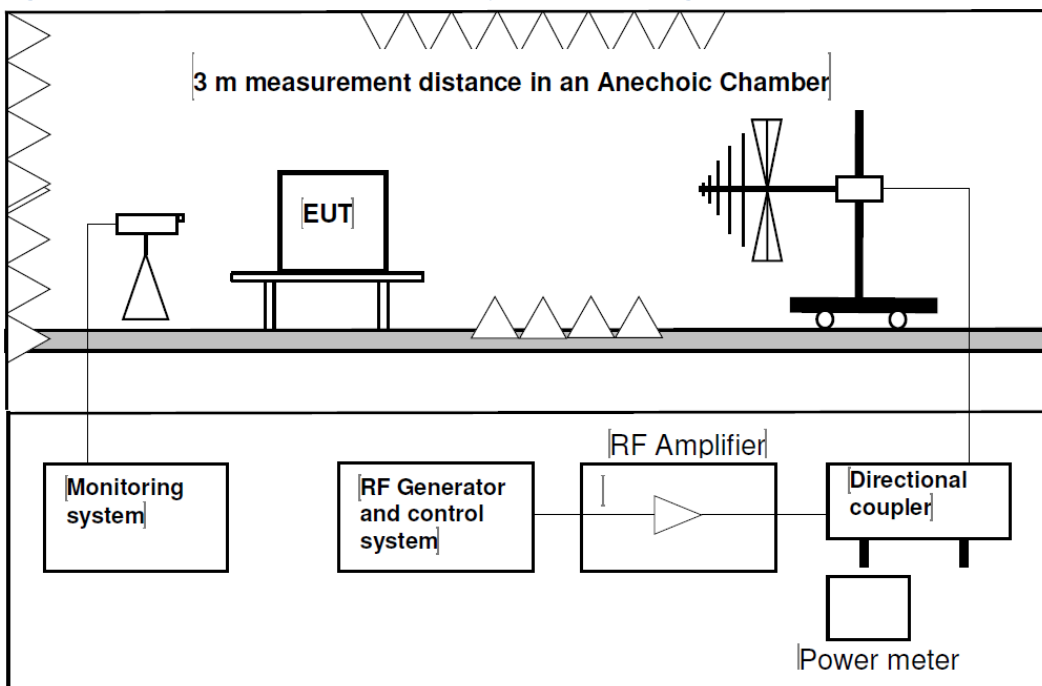

Written by:	Stuart Nottage	Revision	1		
Page	36 of 62	ECR	N/A		
		Date	27/05/2020		

DRB240-48-1 Electromagnetic Compatibility Report 260666

Figure 25 - Radiated Electric Field Immunity, Test Face Diagram



Written by:	Stuart Nottage	Revision	1		
Page	37 of 62	ECR	N/A		
		Date	27/05/2020		

DRB240-48-1 Electromagnetic Compatibility Report 260666

Figure 26 - Radiated Electric Field Immunity, Test Setup Photograph, Face A



Figure 27 - Radiated Electric Field Immunity, Test Setup Photograph, Face B



Written by:	Stuart Nottage	Revision	1		
Page	38 of 62	ECR	N/A		
		Date	27/05/2020		

DRB240-48-1 Electromagnetic Compatibility Report 260666

11.2. Enclosure Port - Test Results

Table 26 - Radiated Electric Field Immunity, DRB240-48-1

Frequency	Level	Face	Result
80 MHz – 1.0 GHz	3	A	Criteria A Pass
		B	Criteria A Pass
1.0 GHz – 6.0 GHz	3	A	Criteria A Pass
		B	Criteria A Pass
900MHz Keyed Carrier from EN61204-3		A	Criteria A Pass
		B	Criteria A Pass

EUT Tested: DRB240-48-1. The EUT met the requirements of EN 61000-4-3:2006 + A2:2010 (level 3, [Enclosure Port]) for Immunity to Radiated Electric Fields. In addition the EUT meets the requirements of EN 61204-3:2000 Keyed Carrier test using the test method of EN 61000-4-3:2006 + A2:2010. For all tests the EUT's performance level met criteria A, as defined in accordance with the specification, see Appendix A.

Procedure	EN 61000-4.3:2006 + A2:2010	Date	30/10/2019
	EN 61204-3:2000	Test Location	TDK-Lambda UK
Environment	21°C; 54%rh; 1004mB	Test Engineers	Paul Dyer

Table 27 - Radiated Electric Field Immunity, Test Equipment

Manufacturer & Description	Serial No.	Calibration Expires	Verified On	Verified By
Maturo Control Unit MCU	599	N/A	19/03/2019	Stuart Nottage
Maturo Turntable TT 2.0 SI	296	N/A	19/03/2019	Stuart Nottage
TRS 3m Semi-Anechoic Chamber	N/A	07/01/2020	19/03/2019	Stuart Nottage
Rohde & Schwarz SMB 100A	115476	02/10/2019	N/A	Paul Dyer
Rohde & Schwarz NRP2	107057	23/09/2019	N/A	Stuart Nottage
Rohde & Schwarz NRP6A	101844	23/09/2019	N/A	Tim Broxholme
Rohde & Schwarz NRP6A	101845	N/A	26/04/2019	Tim Broxholme
TDK RF Solutions SI-300-2 system interface	TRS 102-00063	N/A	09/04/2019	Tim Broxholme
TDK RF Solutions SI-300-2 system interface	TRS 102-00154	N/A	10/04/2019	Tim Broxholme
TDK RF Solutions VOS-02	N/A	N/A	09/04/2019	Tim Broxholme
Ophir RF 5084	1056	N/A	09/04/2019	Tim Broxholme
Prana MT200	1809-2364	N/A	09/04/2019	Tim Broxholme
Prana SX40-15	1809-2365	N/A	09/04/2019	Tim Broxholme
AR FL7000	324648	06/11/2019	09/04/2019	Stuart Nottage
Starprobe FL7006	353333	N/A	09/04/2019	Stuart Nottage
Schwarzbeck VULP 9118E	994	N/A	29/04/2019	Stuart Nottage
AR ATH800M6G	N/A	27/01/2020	29/04/2019	Stuart Nottage
Output Monitor	MOGD02	N/A	29/10/2019	Paul Dyer

Written by:	Stuart Nottage	Revision	1		
		ECR	N/A		
Page	39 of 62	Date	27/05/2020		

12. Immunity to Electrical Fast Transient Bursts to EN61000-4-4

12.1. AC Power Port - Test Procedure

The test was performed according to the specification. The EUT was set up and functioning correctly, as described in Section 4.2. A series of Fast Transient Bursts meeting the specification were applied for a period of 60 seconds. The unit was tested with both 5kHz and 100kHz burst frequencies. The Transient Bursts were applied for both positive and negative burst trains, to both PE and L+N+PE. The Test levels are given below in Table 28.

Table 28 - EFT, AC Power Port, Test levels

Level	Voltage
1	0.5 kV
2	1 kV
3	2 kV
4	4 kV

Figure 28 - EFT, Test Setup

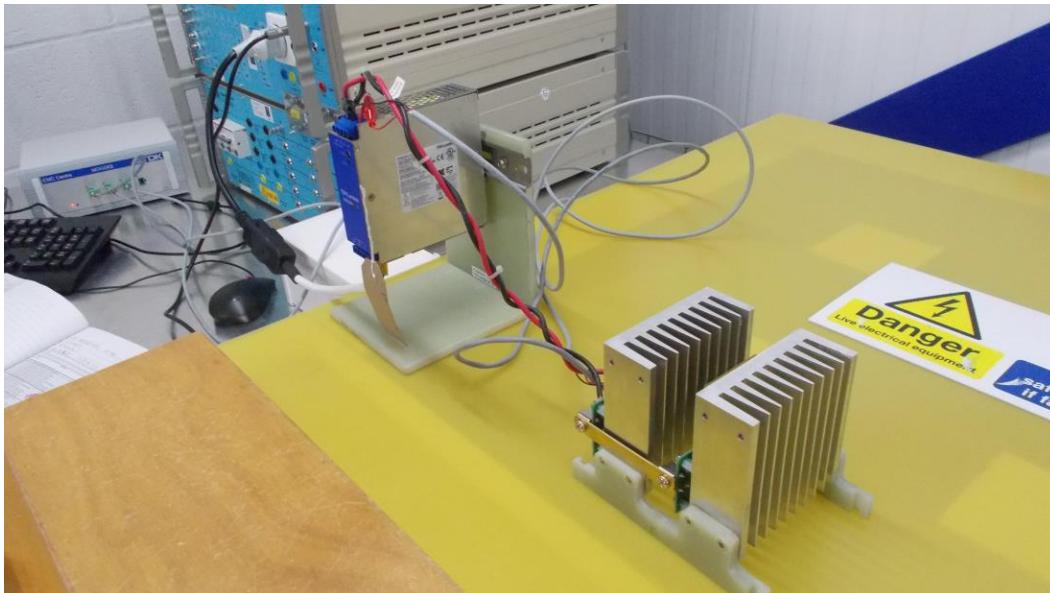

12.2. AC Power Port - Test Results

Table 29 - EFT, AC Power Port Test Results

Unit	Line (Vac)	Level	Pass Criteria	Date
DRB240-48-1	240	4	A	14/11/2019
DRB240-48-1	100	4	A	05/09/2019

Units tested: DRB240-48-1, the EUTs met the requirements of EN 61000-4-4:2012 (level 4, [AC Power Ports]) for Immunity to Fast Transient Bursts. The EUT's performance level met criteria A, as defined in accordance with the specification, see Appendix A.

Procedure	EN 61000-4-4:2012	Date	See above
Environment	21°C; 39%rh; 1002mB	Test Location	TDK-Lambda UK Ltd.
		Test Engineer	Paul Dyer

Written by:	Stuart Nottage	Revision	1		
Page	40 of 62	ECR	N/A		
		Date	27/05/2020		

12.3. DC Power Port- Test Procedure

The EUT was set up and functioning correctly, as described in Section 4.2. The main DC output port was subjected to a series of Fast Transient Bursts meeting the specification using a capacitive coupling clamp for a period of greater than 60 seconds. The test was applied with both 5kHz and 100kHz burst frequencies. The Transient Bursts were applied for both positive and negative burst trains. The test was performed under the conditions specified in TDK-Lambda UK document 72505. During testing of the DC Power Port, the output was fully loaded and the input voltage was 240Vac. The return of the output was tested both floating and grounded to the chassis.

Table 30 - EFT, DC Power Port, Test Levels

Level	Voltage
1	0.5 kV
2	1 kV
3	2 kV
4	4 kV

Figure 29 - EFT, Test Setup, DC Power Port

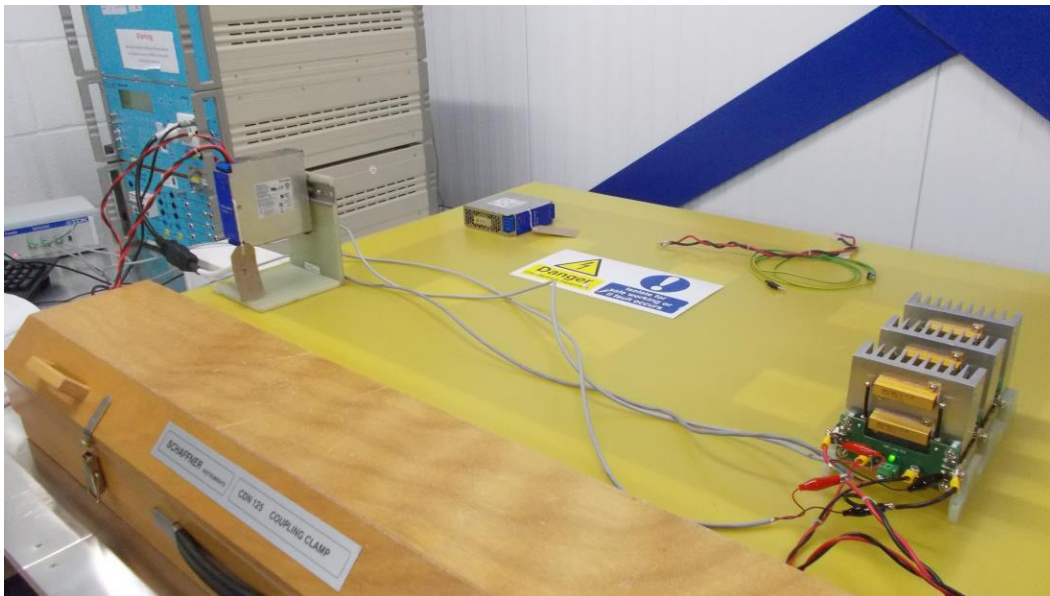

Written by:	Stuart Nottage	Revision	1		
Page	41 of 62	ECR	N/A		
		Date	27/05/2020		

DRB240-48-1 Electromagnetic Compatibility Report 260666

12.4. DC Power Port - Test Results

Table 31 - EFT, DC Power Port Test Results DRB240-48-1

Unit	Output	Output Voltage	Level	Pass Criteria	Date
DRB240-48-1	Float	Nominal	4	A	14/11/2019
DRB240-48-1	Float	Maximum	4	A	14/11/2019
DRB240-48-1	Gnd	Nominal	4	A	14/11/2019
DRB240-48-1	Gnd	Maximum	4	A	14/11/2019

Unit tested: DRB240-48-1, the EUT met the requirements of EN 61000-4-4:2012 (level 4, [DC Power Ports]) for Immunity to Fast Transient Bursts. The EUT's performance level met criteria A, as defined in accordance with the specification, see Appendix A.

Procedure	EN 61000-4-4:2012	Date	14/11/2019
		Test Location	TDK-Lambda UK Ltd.
Environment	21°C; 49%rh; 1012mB	Test Engineer	Paul Dyer

Written by:	Stuart Nottage	Revision	1		
Page	42 of 62	ECR	N/A		
		Date	27/05/2020		

12.5. Signal Port- Test Procedure

The EUT was set up and functioning correctly, as described in Section 4.2. The DC Good signal was subjected to a series of Fast Transient Bursts meeting the specification using a capacitive coupling clamp for a period of greater than 60 seconds. The test was applied with both 5kHz and 100kHz burst frequencies. The Transient Bursts were applied for both positive and negative burst trains. The test was performed under the conditions specified in TDK-Lambda UK documents 72505. During testing of the signal port, the output was fully loaded and the input voltage was 240Vac. The return of the output was tested both floating and grounded to the chassis.

Table 32 - EFT, Signal Port, Test Levels

Level	Voltage
1	0.25 kV
2	0.5 kV
3	1 kV
4	2 kV

Figure 30 - EFT, Test Setup, Signal Port

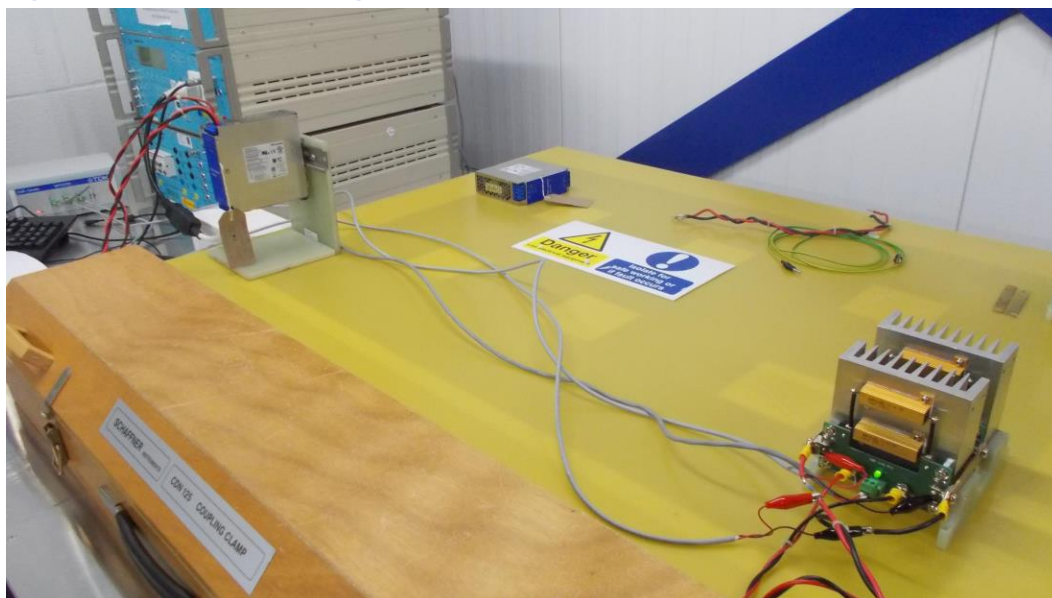

Written by:	Stuart Nottage	Revision	1		
Page	43 of 62	ECR	N/A		
		Date	27/05/2020		

DRB240-48-1 Electromagnetic Compatibility Report 260666

12.6. Signal Port - Test Results

Table 33 - EFT, DC Power Port Test Results DRB240-48-1

Unit	Output	Output Voltage	Level	Pass Criteria	Date
DRB240-48-1	Float	Nominal	4	A	14/11/2019
DRB240-48-1	Float	Maximum	4	A	14/11/2019
DRB240-48-1	Gnd	Nominal	4	A	14/11/2019
DRB240-48-1	Gnd	Maximum	4	A	14/11/2019

Unit tested: DRB240-48-1, the EUT met the requirements of EN 61000-4-4:2012 (level 4, [Signal Ports]) for Immunity to Fast Transient Bursts. The EUT's performance level met criteria A, as defined in accordance with the specification, see Appendix A.

Procedure	EN 61000-4-4:2012	Date	14/11/2019
		Test Location	TDK-Lambda UK Ltd.
Environment	21°C; 49%rh; 1012mB	Test Engineer	Paul Dyer

Table 34 - EFT Test Equipment

Equipment	Serial Number	Calibration	Performance Verified	
		Date Expires	Date	By
EMC partner TRA2000 IN6	1162	16/07/2020	04/11/2019	P Dyer
EMC Partner CN-EFT1000	1728	N/A	04/11/2019	P Dyer
Schaffner CDN125	2789245	N/A	04/11/2019	P Dyer
Fluke DMM	A190	08/10/2019	04/11/2019	P Dyer
Output Monitor	MOGD01	N/A	04/11/2019	P Dyer
Resistive load 48V@1A	RL4812	N/A	04/11/2019	P Dyer
Resistive load 40V@1.3A	RL4002	N/A	04/11/2019	P Dyer
Resistive load 12V@8A	RL1236	N/A	04/11/2019	P Dyer
Resistive load 12V@2A	RL1212	N/A	04/11/2019	P Dyer

Written by:	Stuart Nottage	Revision	1		
		ECR	N/A		
		Date	27/05/2020		
Page	44 of 62				

13. Combination Wave Surge Immunity to EN61000-4-5

13.1. AC Power Port - Test Procedure

The test was performed according to the specification. The EUT was set up and functioned correctly, as described in section 4.2. A series of high energy surges were applied as shown in Table 35 below.

Table 35 - Surge, Test levels

Installation Class	Coupling	Level	Voltage
1	Line to Neutral (2 Ohm)	1	N/A
	Line or Neutral to Ground (12 Ohm)		0.5kV
2	Line to Neutral (2 Ohm)	2	0.5kV
	Line or Neutral to Ground (12 Ohm)		1kV
3	Line to Neutral (2 Ohm)	3	1kV
	Line or Neutral to Ground (12 Ohm)		2kV
4	Line to Neutral (2 Ohm)	4	2kV
	Line or Neutral to Ground (12 Ohm)		4kV

For each of the above applicable test conditions, five positive and five negative pulses were applied, each applied at intervals of 30 seconds. Correct functioning of the EUT throughout the test was checked using the procedures described in Section 4.2.

Figure 31 - Surge Immunity, Test Setup

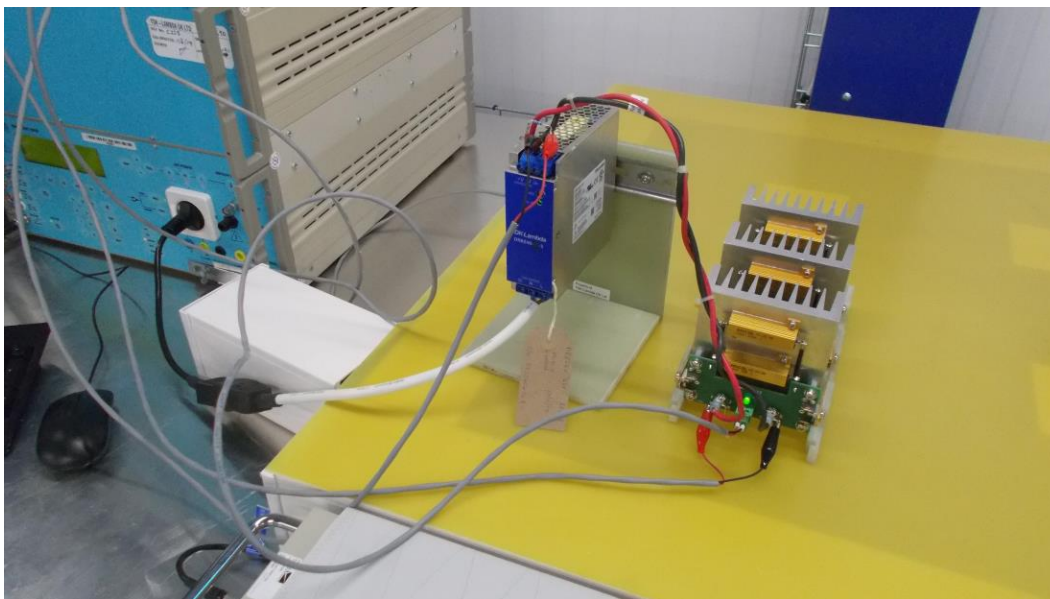

Written by:	Stuart Nottage	Revision	1		
Page	45 of 62	ECR	N/A		
		Date	27/05/2020		

DRB240-48-1 Electromagnetic Compatibility Report 260666

13.2. AC Input Port - Test Results

Table 36 - Surge, Test Results DRB240-48-1

Unit	Line	Load	Output Voltage	Level	Pass Criteria	Date
DRB240-48-1	240Vac	Full	Nominal	3	A	31/10/2019
DRB240-48-1	240Vac	Full	Max	3	A	31/10/2019
DRB240-48-1	240Vac	Full	Max, Return Gnd	3	A	31/10/2019
DRB240-48-1	100Vac	Full	Max	3	A	01/11/2019
DRB240-48-1	100Vac	Full	Max, Return Gnd	3	A	01/11/2019
DRB240-48-1	240Vac	Zero	Nominal	3	A	31/10/2019

Unit tested: DRB240-48-1, the EUT met the requirements of EN 61000-4-5: 2014+A1:2017 (Installation Class 3, [AC Power Ports]) for Immunity to Combination Wave Surges. The EUT's performance level met criteria A, as defined in accordance with the specification, see Appendix A.

Procedure	EN 61000-4-5:2014+A1:2017	Date	As above
		Test Location	TDK-Lambda UK Ltd.
Environment	19°C; 58%rh; 1012mB	Test Engineer	Nick Heighington

Table 37 - Surge Test Equipment

Equipment	Serial Number	Calibration	Performance Verified	
		Date Expires	Date	By
EMC partner TRA2000 IN6	1162	16/07/2020	24/10/2019	Stuart Nottage
Output Monitor	MOGD01	N/A	31/10/2019	NH
Resistive Load 48V@1A	RL4811	N/A	31/10/2019	NH
Resistive Load 48V@2A	RL4802	N/A	31/10/2019	NH
Resistive Load 48V@2A	RL4803	N/A	31/10/2019	NH

Written by:	Stuart Nottage	Revision	1		
		ECR	N/A		
		Date	27/05/2020		
Page	46 of 62				

14. Immunity to Conducted RF Disturbances to EN61000-4-6

14.1. Test Procedure

The test was performed according to the specification. The EUT was set up and functioning correctly. The input mains was connected through a coupling decoupling network (CDN) and functioned correctly. The EUT was subjected to Radio-Frequency fields injected into each applicable port via a suitable CDN, a second port is selected to be terminated in accordance with the standard. The frequency was swept from 150 kHz to 80 MHz, amplitude modulated with a 1 kHz sine wave to a depth of 80%. The test levels are detailed Table 38 below. The test was performed on the AC Port at 240Vac and 100Vac, and on the DC Power Port at nominal and maximum output voltage. Correct functioning of the EUT was checked throughout the test by using the procedure described in Section 4.2.

Figure 32 - Conducted RF Immunity, Test Setup Diagram AC Port

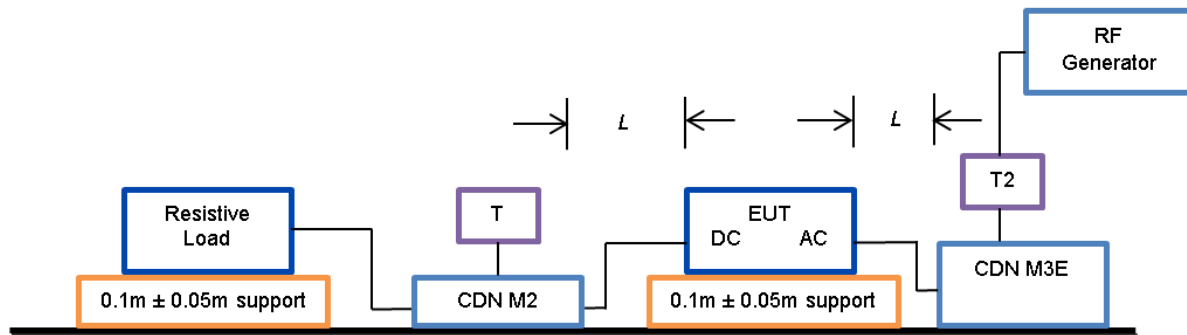

Where:
 $0.1\text{ m} \leq L \leq 0.3\text{ m}$
 T = 50 Ω termination
 T2 = 6 dB attenuator

Figure 33 - Conducted RF Immunity, Test Setup Diagram DC Port

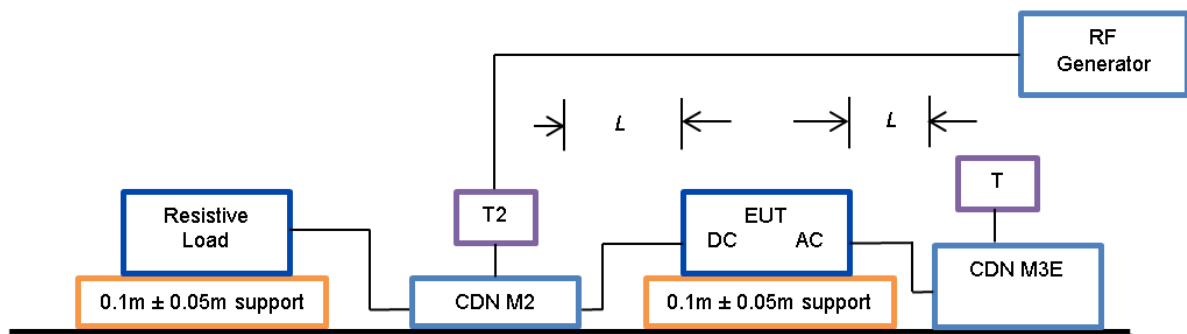

Where:
 $0.1\text{ m} \leq L \leq 0.3\text{ m}$
 T = 50 Ω termination
 T2 = 6 dB attenuator

Written by:	Stuart Nottage	Revision	1		
Page	47 of 62	ECR	N/A		
		Date	27/05/2020		

DRB240-48-1 Electromagnetic Compatibility Report 260666

Table 38 - Conducted RF Immunity, Test Levels

Level	Voltage
1	1
2	3
3	10
x	special

Figure 34 - Conducted RF Immunity, Test Setup Photograph

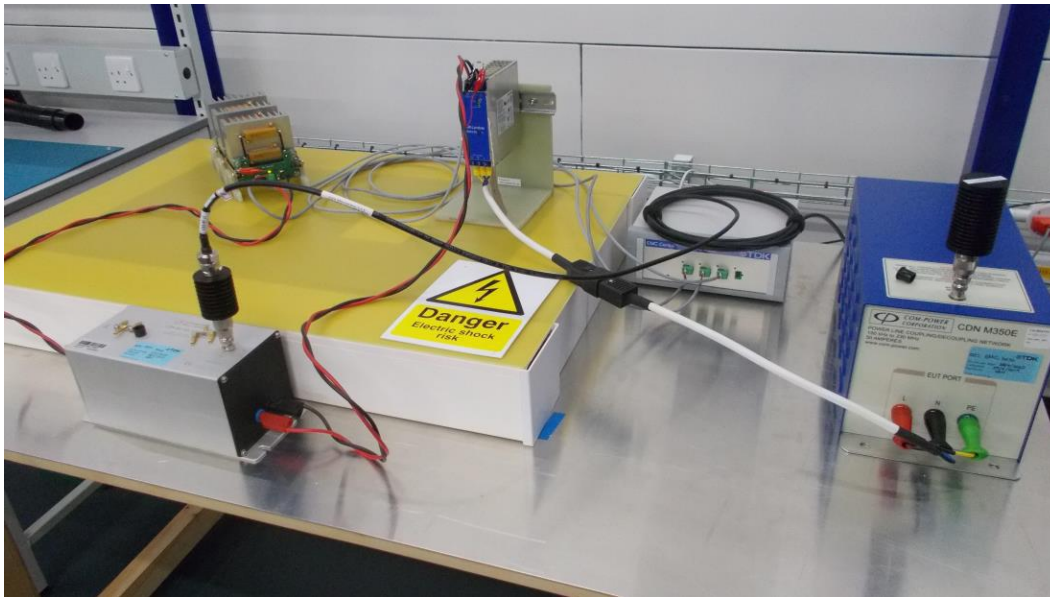

14.2. Test Results

Table 39 - Conducted RF, Test Results DRB240-48-1

Input Voltage	Output Voltage	Tested Port	Terminated Port	Level	Pass Criteria
240V	Nominal	AC	DC	3	A
100V	Nominal	AC	DC	3	A
240V	Nominal	DC	AC	3	A
240V	Maximum	DC	AC	3	A
240V	Maximum, 0V GND	DC	AC	3	A
100V	Maximum	DC	AC	3	A

EUT Tested: DRB240-48-1. The EUT passed the requirements of EN 61000-4-6: 2014 (Level 3, [AC Input port and DC Output Ports]) for Immunity to Conducted disturbances, induced by Radio-Frequency Fields. The EUT's performance level met criteria A, as defined in accordance with the specification, see Appendix A.

Procedure	EN 61000-4-6:2014	Date	15/11/2019
		Test Location	TDK-Lambda UK
Environment	20°C; 38%rh; 999 mB	Test Engineer	Paul Dyer

Written by:	Stuart Nottage	Revision	1		
		ECR	N/A		
		Date	27/05/2020		
Page	48 of 62				

DRB240-48-1 Electromagnetic Compatibility Report 260666

Table 40 - Conducted RF Immunity, Test Equipment

Equipment	Serial Number	Calibration	Performance Verified	
		Date Expires	Date	By
Rohde & Schwarz SMB 100A	115476	24/10/2020	N/A	N/A
Rohde & Schwarz NRP2	107057	23/10/2020	N/A	N/A
Rohde & Schwarz NRP6A	101844	22/10/2020	N/A	N/A
Rohde & Schwarz NRP6A	101845	22/10/2020	N/A	N/A
TDK RF Solutions SI-300-2 system interface	TRS 102-00063	N/A	10/04/2019	Tim Broxholme
TDK RF Solutions SI-300-2 system interface	TRS 102-00154	N/A	10/04/2019	Tim Broxholme
TDK RF Solutions VOS-02	N/A	N/A	10/04/2019	Tim Broxholme
Ophir RF 5084	1056	N/A	10/04/2019	Tim Broxholme
Schwarzbeck CDN M2 32A	7	27/01/2020	28/01/2019	Paul Dyer
Schwarzbeck CDN M2 125A	2	08/04/2020	09/04/2019	Stuart Nottage
Com-Power CDN M350E 50A	521332	28/04/2020	29/04/2019	Stuart Nottage
Schwarzbeck CDN AF2	4	09/04/2020	10/04/2019	Tim Broxholme
Schwarzbeck SR100-6W	#103	N/A	10/04/2019	Tim Broxholme
Schwarzbeck SR100-6W	#104	N/A	10/04/2019	Tim Broxholme
Fairview Microwave SA3N10W-10	150227073	N/A	10/04/2019	Tim Broxholme
Fairview Microwave SA4N251-06	16111010	N/A	10/04/2019	Tim Broxholme
Fairview Microwave ST3N252	N/A	N/A	10/04/2019	Tim Broxholme
ENS Microwave LLC LMR240UF-275.6-MNS	EMS RF-22	N/A	10/04/2019	Tim Broxholme
ENS Microwave LLC LMR240UF-275.6-MNS	EMS RF-23	N/A	10/04/2019	Tim Broxholme
Glitch Detector	MOGD01	N/A	15/11/2019	Paul Dyer

Written by:	Stuart Nottage	Revision	1		
Page	49 of 62	ECR	N/A		
		Date	27/05/2020		

15. Power Frequency Magnetic Field Immunity to EN61000-4-8

15.1. Enclosure Port - Test Procedure

The test was performed according to the specification. The EUT was set up on a table within the field coils and checked to be functioning correctly. A 50Hz and a 60Hz Magnetic field was applied in accordance with the specification at the levels detailed in Table 41 below. The EUT was tested in three orthogonal orientations for greater than 1 minute in each. Correct functioning of the EUT throughout the test was checked by using the procedures described in Section 4.2.

Table 41 - PF Magnetic Field, Test Levels

Level	Continuous Magnetic Field Strength (A/m)	Short Term Magnetic Field Strength (A/m)
1	1	N/A
2	3	N/A
3	10	N/A
4	30	300
5	100	1000

Figure 35 - PF Magnetic Field, Setup Photograph, Orientation X

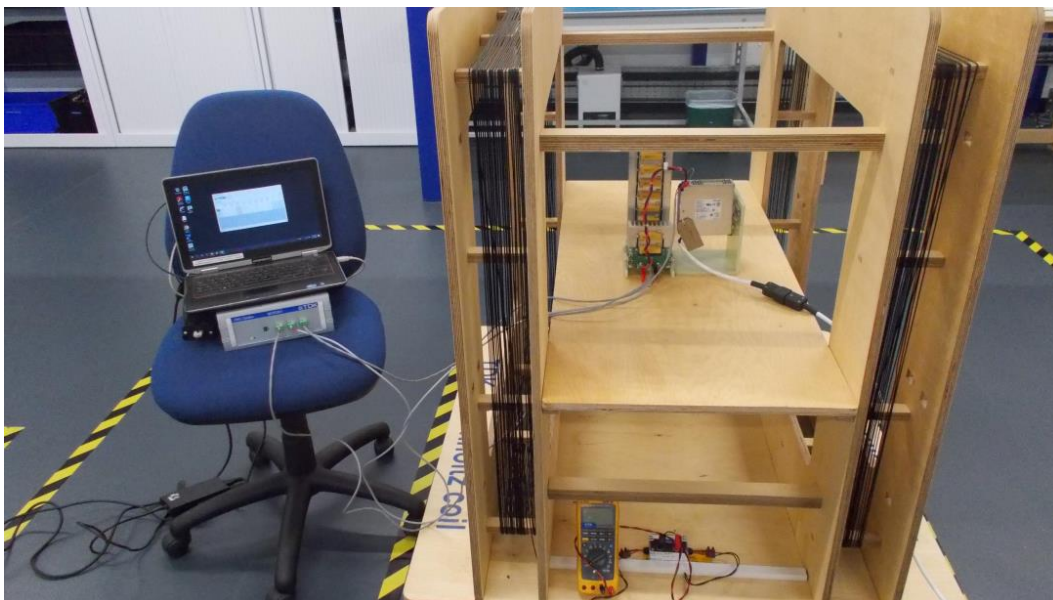

Written by:	Stuart Nottage	Revision	1		
Page	50 of 62	ECR	N/A		
		Date	27/05/2020		

DRB240-48-1 Electromagnetic Compatibility Report 260666

Figure 36 - PF Magnetic Field, Setup Photograph, Orientation Y

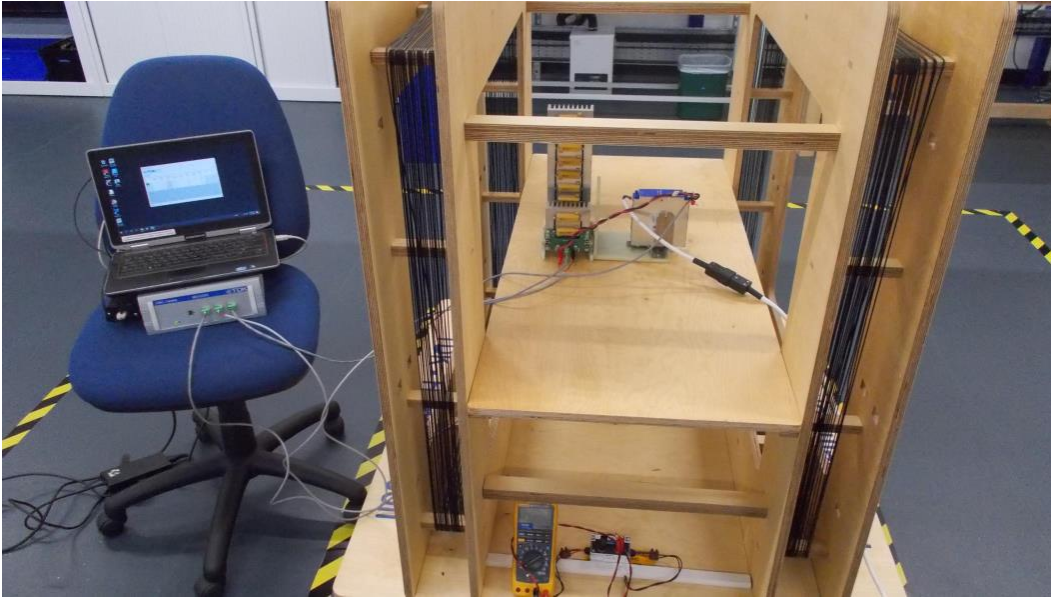
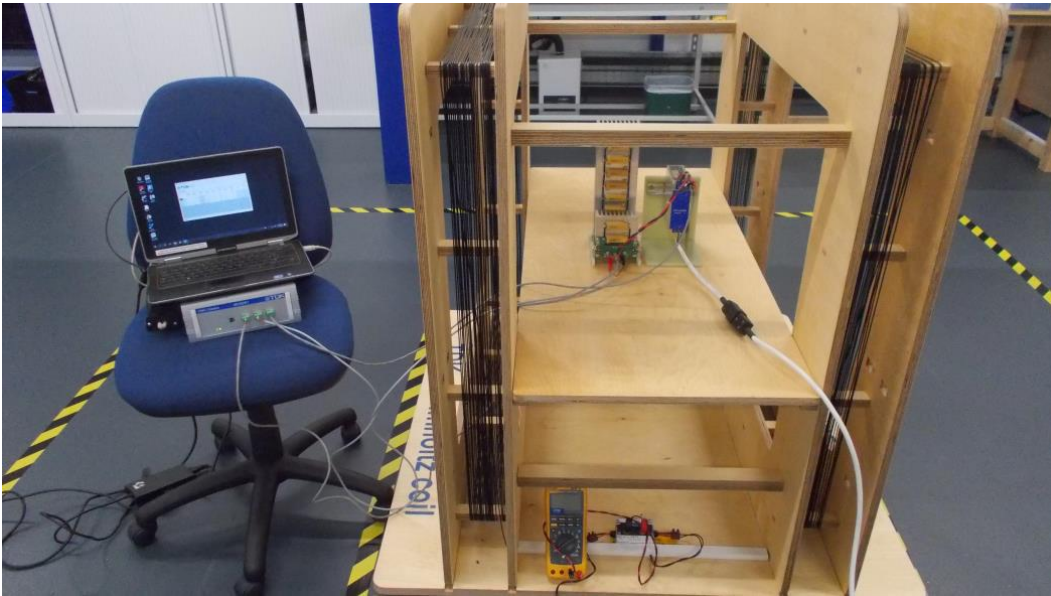

Figure 37 - PF Magnetic Field, Setup Photograph, Orientation Z



Written by:	Stuart Nottage	Revision	1		
Page	51 of 62	ECR	N/A		
		Date	27/05/2020		

DRB240-48-1 Electromagnetic Compatibility Report 260666

15.2. Enclosure Port - Test Results

Table 42 - PF Magnetic Field, Test Results DRB240-48-1

Unit	Type	Level	Field	Result Criteria	Pass / Fail
DRB240-24-1	Continuous	4	30Am ⁻¹ 50Hz	A	PASS
DRB240-24-1	Short duration	4	300Am ⁻¹ 50Hz	A	PASS
DRB240-24-1	Continuous	4	30Am ⁻¹ 60Hz	A	PASS
DRB240-24-1	Short duration	4	300Am ⁻¹ 60Hz	A	PASS

Unit Tested: DRB240-24-1. The EUT passed the requirements of EN 61000-4-8: 2010 (Level 4, [Enclosure port]) for Immunity to Power Frequency Magnetic Fields. The EUT's performance level met criteria A, as defined in accordance with the specification, see Appendix A.

Procedure	EN 61000-4-8:2010	Date	09/09/2019
		Test Location	TDK-Lambda UK
Environment	21°C; 44%rh; 1008mB	Test Engineer	Paul Dyer

Table 43 - PF Magnetic Field, Test Equipment,

Equipment	Calibration ID	Calibration Date Expires
Helmholtz Coil HHC	002	N/A
Fluke 287 DMM	J214	15/01/2020
Calibrated Shunt	P74	08/10/2019
Resistive Load 48V@4A	RL4822	N/A
Resistive Load 48V@1A	RL4811	N/A
Glitch Detector MOGD01	N/A	N/A

Written by:	Stuart Nottage	Revision	1		
		ECR	N/A		
Page	52 of 62	Date	27/05/2020		

16. Immunity to Voltage Dips, Interruptions and Variations to EN61000-4-11

16.1. AC Power Port - Test Procedure

The test was performed according to the specifications. The EUT was set up and functioned correctly. A series of voltage dips and interruptions were applied to the input. The test was performed for 220Vac 50Hz nominal, and 100Vac 50Hz nominal. Correct functioning of the EUT throughout the test was checked by using the procedures described in Section 4.2, and with the use of an oscilloscope.

Figure 38 – Dips & Interruptions, Setup Photograph

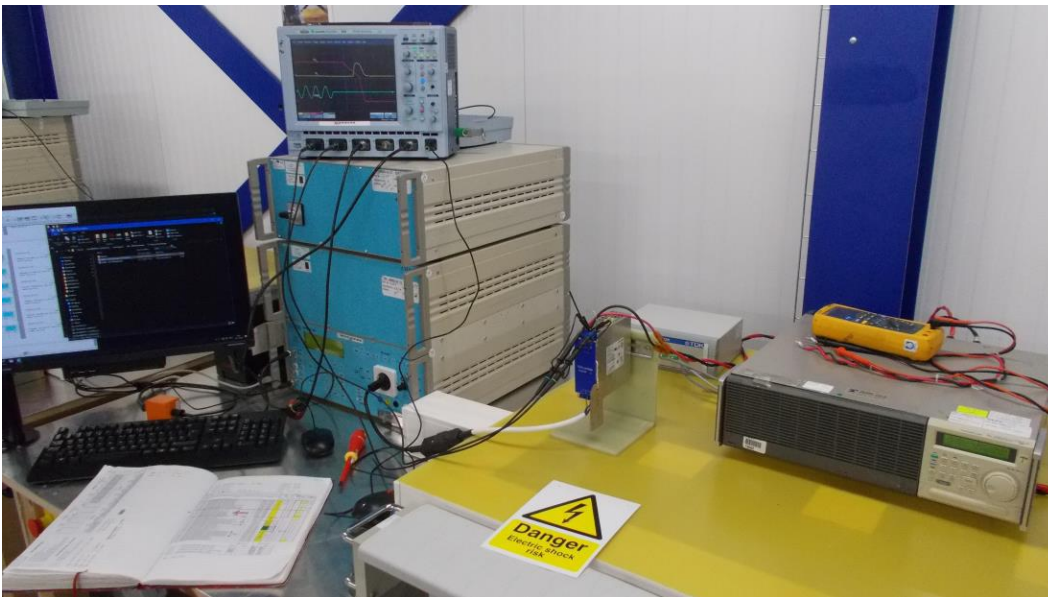

Written by:	Stuart Nottage	Revision	1		
Page	53 of 62	ECR	N/A		
		Date	27/05/2020		

DRB240-48-1 Electromagnetic Compatibility Report 260666

16.2. AC Power Port - Test Results

Table 44 – Voltage Dips & Interruptions, DRB240-48-1, 230Vac, Test Results

Standard	Test	Required Pass Criteria	Result Criteria	Verdict
EN 61000-4-11 Class 3	0% ½ cycle	B	A	PASS
	0% 1 cycle	B	A	
	40% 10/12 cycles	B	A	
	70% 25/30 cycles	B	A	
	80% 250/300 cycles	B	A	
	0% 250/300 cycles	B	B	
EN 61204-3:2000	70% 10ms	B	A	PASS
	40% 100ms	B	A	
	0% 5000ms	B	B	

Table 45 – Voltage Dips & Interruptions, DRB240-48-1, 100Vac, Test Results

Standard	Test	Required Pass Criteria	Result Criteria	Verdict
EN 61000-4-11 Class 3	0% ½ cycle	B	A	PASS
	0% 1 cycle	B	A	
	40% 10/12 cycles	B	B	
	70% 25/30 cycles	B	B	
	80% 250/300 cycles	B	A	
	0% 250/300 cycles	B	B	
EN 61204-3:2000	70% 10ms	B	A	PASS
	40% 100ms	B	B	
	0% 5000ms	B	B	

Unit Tested: DRB240-48-1. The unit passed the Class 3 requirements of EN 61000-4-11; 2004 [Power Ports] for Immunity to Voltage Dips and Interruptions. In addition the requirements of EN 61204-3:2018 and EN 61204-3:2000 were also met. The Criteria for each test is given in the tables above, see Appendix A for details.

Procedure	EN 61000-4-11:2004	Date	18/11/2019
	EN61204-3:2018	Test Location	TDK-Lambda UK Ltd.
	EN61204-3:2000	Test Engineer	Paul Dyer

Table 46 – Voltage Dips & Interruptions, Test Equipment

Equipment	Serial Number / Cal ID	Calibration Date Expires
EMC Partner TRA2000 IN6	789	11/06/2020
EMC Partner Variac VAR-EXT1000	1563	11/06/2020
Oscilloscope	E193	09/10/2020
Kikusui electronic load	J219	07/10/2020
Fluke digital multimeter	A190	07/10/2020

Written by:	Stuart Nottage	Revision	1		
	54 of 62	ECR	N/A		
		Date	27/05/2020		

Appendix A – Immunity Performance Criteria

Performance Criterion A

The unit remains within the performance level specified in Table 47 below throughout the testing.

Table 47 - Immunity performance level for Criteria A

Parameter	Performance level during immunity tests
Output Voltage set point	Within $\pm 5\%$ of set point with a blanking time of 7ms is used. Within $\pm 10\%$ of set point with a blanking time of 4ms is used.
DC Good Signal Port	Continue to give correct signal throughout testing

Performance Criterion B

The unit's performance drops below the levels in Table 47 above during the test, but recovers to within this performance level after the test has completed without user intervention.

Performance Criterion C

The unit's performance drops below the levels in Table 47 above during the test, but after user intervention⁵ recovers to within this performance level after the test has completed.

Performance Criterion D

The unit's performance drops below the levels in Table 47 above during the test, and cannot be made to recover to within this performance level after the test has completed, without replacement of components. Alternatively, if evidence of physical damage can be seen⁶ even if performance levels are acceptable.

⁵ By recycling the input power.

⁶ Damaged components, or smoke, fire etc.

Written by:	Stuart Nottage	Revision	1		
Page	55 of 62	ECR	N/A		
		Date	27/05/2020		

DRB240-48-1 Electromagnetic Compatibility Report 260666

Appendix B – Measurement Instrument Uncertainty

For emissions measurements the uncertainty is measured in accordance with CISPR 16-4-2. This standard defines limits for the values of U_{cispr} as follows:

Measurement	U_{cispr}
Conducted Disturbance (mains port) 150 kHz – 30 MHz	3.60 dB
Radiated disturbance (electric field strength in Semi-Anechoic Chamber) 30 MHz – 1000 MHz	5.20 dB

Calculations of U_{lab} for the conducted emissions test facility at TDK-Lambda UK

Input Quantity		Uncertainty of X_i		$u(X_i)$	c_i	$c_i u(x_i)$
Description	X_i	$\pm dB$	Probability Distribution Function	dB		dB
Receiver Reading	V_r	0.10	k=1	0.10	1	0.10
Attenuation: AMN-receiver	L_c	0.20	k=2	0.10	1	0.10
Attenuation: Pulse limiter	L_{pl}	0.20	k=2	0.10	1	0.10
AMN Voltage division factor	L_{amn}	0.25	Rectangular	0.14	1	0.14
Receiver:						
Sine wave voltage	∂V_{sw}	0.07	k=2	0.04	1	0.04
Pulse amplitude response	∂V_{pa}	0.37	Rectangular	0.21	1	0.21
Pulse repetition rate response	∂V_{pr}	0.05	Rectangular	0.03	1	0.03
Noise floor proximity	∂V_{nf}	0.00	Rectangular	0.00	1	0.00
Mismatch: AMN-receiver	∂M	0.80	U-shaped	0.53	1	0.53
AMN Impedance	∂Z	1.94	Triangular	0.78	1	0.78
					$2 u_c(V) =$	1.99

Written by:	Stuart Nottage	Revision	1		
Page	56 of 62	ECR	N/A		
		Date	27/05/2020		

DRB240-48-1 Electromagnetic Compatibility Report 260666

U_{lab} for the horizontal radiated emissions test facility at TDK-Lambda UK

Input Quantity		Uncertainty of Xi		u(Xi)	ci	ci u(xi)
Description	Xi	±dB	Probability	dB		dB
			Distribution Function			
Receiver Reading	Vr	0.10	k=1	0.10	1	0.10
Attenuation: Antenna-receiver	Lc	0.10	k=2	0.05	1	0.05
Receiver:						
Sine wave voltage	∂Vsw	0.07	k=2	0.04	1	0.04
Pulse amplitude response	∂Vpa	0.40	Rectangular	0.23	1	0.23
Pulse repetition rate response	∂Vpr	0.05	Rectangular	0.03	1	0.03
Noise floor proximity	∂Vnf	0.00	Rectangular	0.00	1	0.00
Mismatch: Antenna-receiver	∂M	0.90	U-shaped	0.60	1	0.60
Antenna Corrections						
AF frequency interpolation	∂Aff	0.30	Rectangular	0.17	1	0.17
Antenna directivity (3m)	∂Adir	0.00	Rectangular	0.00	1	0.00
AF height deviations	∂Afh	0.50	Rectangular	0.29	1	0.29
Phase Centre Location	∂Aph	0.00	Rectangular	0.00	1	0.00
Cross-polarisation	∂Acp	0.00	Rectangular	0.00	1	0.00
Antenna Balance	∂Abal	0.50	Rectangular	0.29	1	0.29
Site Imperfections	∂SA	2.00	Triangular	0.80	1	0.80
Separation Distance (3m)	∂d	0.30	Rectangular	0.17	1	0.17
Table Height	∂h	0.10	k=2	0.05	1	0.05
					2 uc(V) =	2.28

Written by:	Stuart Nottage	Revision	1		
Page	57 of 62	ECR	N/A		
		Date	27/05/2020		

DRB240-48-1 Electromagnetic Compatibility Report 260666

U_{lab} for the vertical radiated emissions test facility at TDK-Lambda UK

Input Quantity		Uncertainty of X_i		$u(X_i)$	c_i	$c_i u(x_i)$
Description	X_i	$\pm dB$	Probability	dB		dB
			Distribution Function			
Receiver Reading	V_r	0.10	k=1	0.10	1	0.10
Attenuation: Antenna-receiver	L_c	0.10	k=2	0.05	1	0.05
Receiver:						
Sine wave voltage	∂V_{sw}	0.07	k=2	0.04	1	0.04
Pulse amplitude response	∂V_{pa}	0.40	Rectangular	0.23	1	0.23
Pulse repetition rate response	∂V_{pr}	0.05	Rectangular	0.03	1	0.03
Noise floor proximity	∂V_{nf}	0.00	Rectangular	0.00	1	0.00
Mismatch: Antenna-receiver	∂M	0.90	U-shaped	0.60	1	0.60
Antenna Corrections						
AF frequency interpolation	∂A_{ff}	0.30	Rectangular	0.17	1	0.17
Antenna directivity (3m)	∂A_{dir}	0.00	Rectangular	0.00	1	0.00
AF height deviations	∂A_{fh}	0.50	Rectangular	0.29	1	0.29
Phase Centre Location	∂A_{ph}	0.00	Rectangular	0.00	1	0.00
Cross-polarisation	∂A_{cp}	0.00	Rectangular	0.00	1	0.00
Antenna Balance	∂A_{bal}	0.50	Rectangular	0.29	1	0.29
Site Imperfections	∂S_A	3.20	Triangular	1.28	1	1.28
Separation Distance (3m)	∂d	0.30	Rectangular	0.17	1	0.17
Table Height	∂h	0.10	k=2	0.05	1	0.05
					$2 u_c(V) =$	3.03

$2 u_c(V)$ is the calculation of U_{lab} , as for both conducted emissions and radiated emissions this is less than U_{cispr} , the unmodified limit lines can be used to determine compliance or non-compliance.

Written by:	Stuart Nottage	Revision	1		
Page	58 of 62	ECR	N/A		
		Date	27/05/2020		

DRB240-48-1 Electromagnetic Compatibility Report 260666

Appendix C – Equipment Under Test

The following units were used for the testing in this report, details of which unit(s) were subjected to which tests are given on the relevant pages of the test report.

Table 48 – DRB240-48 Test Sample List

Unit	Radiated Emissions	Conducted Emissions	Harmonics	Flicker	ESD	Radiated Immunity	EFT	Surge	Conducted Immunity	PF Magnetic Field	Dips & Interruptions
DRB240-48-1 7KJ2404219	X	X			X	X		X			
DRB240-48-1 7KJ2404238	X										
DRB240-48-1 7KJ2404241	X						X		X	X	X
DRB240-48-1 7KJ2404231			X	X							

Written by:	Stuart Nottage	Revision	1		
Page	59 of 62	ECR	N/A		
		Date	27/05/2020		

Appendix D – References

Table 49 - National & International Standards

Document Number	Title
Directive 2014/30/EU	Directive 2014/30/EU of the European Parliament and the Council of 26 February 2014 on the harmonisation of the laws of the Member States relating to electromagnetic compatibility (recast)
BS EN 61204-3:2018	Low-voltage switch mode power supplies - Part 3: Electromagnetic compatibility (EMC)
BS EN 61000-3-2: 2014	Electromagnetic compatibility (EMC) – Part 3-2: Limits for harmonic current emissions (equipment input current ≤ 16 A per phase)
BS EN 61000-3-3: 2013	Electromagnetic compatibility (EMC) – Part 3-3: Limitation of voltage fluctuations and flicker in low-voltage supply systems for equipment with rated current ≤ 16 A
BS EN 61000-4-2: 2009	Electromagnetic compatibility (EMC) – Part 4-2: Testing and measurement techniques – Electrostatic discharge immunity test
BS EN 61000-4-3: 2006 + A2:2010	Electromagnetic compatibility (EMC) – Part 4-3: Testing and measurement techniques – Radiated, radio frequency, electromagnetic field immunity test
BS EN 61000-4-4: 2012	Electromagnetic compatibility (EMC) – Part 4-4: Testing and measurement techniques – Electrical fast transient burst immunity test
BS EN 61000-4-5: 2014 + A1:2017	Electromagnetic compatibility (EMC) – Part 4-5: Testing and measurement techniques – Surge immunity test
BS EN 61000-4-6: 2014	Electromagnetic compatibility (EMC) – Part 4-6: Testing and measurement techniques – Immunity to conducted disturbances, induced by radio frequency fields
BS EN 61000-4-7: 2002 +A1: 2009	Electromagnetic compatibility (EMC) – Part 4-7: Testing and measurement techniques – General guide on harmonics and interharmonics measurements and instrumentation, for power supply systems and equipment connected hitherto
BS EN 61000-4-8: 2010	Electromagnetic compatibility (EMC) – Part 4-8: Testing and measurement techniques – Power frequency magnetic field immunity test
BS EN 61000-4-11: 2004 + A1:2017	Electromagnetic compatibility (EMC) – Part 4-11: Testing and measurement techniques – Voltage dips, short interruptions and voltage variations immunity test
BS EN 55011: 2016 + A1:2017	Industrial, scientific and medical (ISM) radio-frequency equipment – Electromagnetic disturbance characteristics – Limits and methods of measurement
FCC Title 47, Chapter 1, Part 15.107 – 2020	Federal Communications Commission, Title 47, Part 15- Radio Frequency Devices, 107, Conducted limits.
FCC Title 47, Chapter 1, Part 15.109 – 2020	Federal Communications Commission, Title 47, Part 15- Radio Frequency Devices, 109, Radiated Emissions limits.

Table 50 - TDK-Lambda UK Procedures

Document Number	Title
69896 iss 5, 2019	EMC Design Verification Tests
72500 iss 3, 2018	EMC Procedures: C16 - Conducted Emissions
72501 iss 4, 2018	EMC Procedures: C17 - Radiated Emissions
72502 iss 2, 2019	EMC Procedures: C11.2 - Voltage Flicker
72503 iss 3, 2016	EMC Procedures: R10 - Electrostatic Discharge (ESD) Immunity
72504 iss 4, 2017	EMC Procedures: R11 - Radio Frequency, Electromagnetic Field Immunity.
72505 iss 5, 2016	EMC Procedures: R12 - Electrical Fast Transient Burst Immunity
72506 iss 6, 2017	EMC Procedures: R13 - Surge Immunity and Ring Wave Surge Immunity
72507 iss 3, 2016	EMC Procedures: R14 - Conducted Disturbances, Induced By Radio-frequency Fields Immunity
72508 iss 3, 2016	EMC Procedures: R15 - Power Frequency Magnetic Field Immunity
72509 iss 4, 2016	EMC Procedures: R16 - Voltage Dips, Short Interruptions and Voltage Variations Immunity
60802 iss 4, 2015	EMC Procedures: C-12 - Harmonic Current Emissions
260514-2	DRB120 12 and 48V Design Specification V2

Written by:	Stuart Nottage	Revision	1		
	Page	60 of 62	ECR	N/A	
			Date	27/05/2020	

Appendix E – Testing Locations

Where the report states the test location as *TDK-Lambda UK* this is:

TDK-Lambda UK Limited
Kingsley Avenue
Ilfracombe
Devon
EX34 8ES
United Kingdom

Written by:	Stuart Nottage	Revision	1		
Page	61 of 62	ECR	N/A		
		Date	27/05/2020		

Appendix F – Revision History

Revision	ECR	Changes	Issued By	Date
1	N/A	Initial Version	Stuart Nottage	27/05/2020

Written by:	Stuart Nottage	Revision	1		
Page	62 of 62	ECR	N/A		
		Date	27/05/2020		