

# KS10

## RELIABILITY DATA

### 信頼性データ

No. RD-08T-1448		
承認	査閲	担当
<i>Kawamura</i> 31. Oct. '08	<i>Y. Kihama</i> 30. Oct. '08	<i>M. Nagai</i> 30. Oct. '08

# INDEX

	PAGE
1. MTBF計算値 Calculated Values of MTBF -----	R - 1
2. 部品デイレートイング Component Derating -----	R - 2
3. 主要部品温度上昇値 Temperature Rise $\Delta T$ -----	R - 5
4. 電解コンデンサ推定寿命計算値 Elec. Capacitor Computed Life -----	R - 6
5. アブノーマル試験 Abnormal Test -----	R - 11
6. 振動試験 Vibration Test -----	R - 17
7. ノイズシミュレート試験 Noise Simulate Test -----	R - 18
8. 静電気シミュレート試験 Electro-Static Discharge Test -----	R - 19
9. 雷サージ試験 Impulse Test -----	R - 20
10. 雑音端子電圧 Conducted Emission -----	R - 21

※信頼性データは、代表データであり、全ての製品は、ほぼ同等な特性を示します。  
従いまして、この値は実力値とお考え願います。

The above data is typical value. As all units have nearly the same characteristics, the data to be considered as ability value.

## 1. MTBF 計算値 CALCULATED VALUES OF MTBF

MODEL : KS10

## (1) 算出方法 Part count reliability projection

(社) 日本電子機械工業会 直流安定化電源 (スイッチング方式) 委員会の部品点数法で算出されています。

それぞれの部品ごとに、部品故障率 $\lambda_G$ が与えられ、各々の点数によって決定されます。 $\lambda_G$ は、MIL-HDBK-217Dに準じて定められています。

Calculated based on part count reliability projection by the Technical Committee on Stabilized Power Supplies of EIAJ.

Fixed failure rate  $\lambda_G$  is given to each individual part and MTBF is determined by the count of each part.

$\lambda_G$  is determined based on MIL-HDBK-217D.

<算出式>

$$MTBF = \frac{1}{\lambda_{equip}} = \frac{1}{\sum_{i=1}^n Ni(\lambda_G)_i} \times 10^6 \text{ 時間 (Hours)}$$

$\lambda_{equip}$  : 全機器故障率 (故障数/10<sup>6</sup>時間)

Total Equipment Failure Rate (Failure/10<sup>6</sup>Hour)

$\lambda_G$  : i 番目の同属部品に対する故障率 (故障数/10<sup>6</sup>時間)

Generic Failure Rate for The ith Generic Part

$N_i$  : i 番目の同属部品の個数

Quantity of ith Generic Part

$n$  : 異なった同属部品のカテゴリーの数

Number of Different Generic Part Categories

## (2) MTBF 値

$$MTBF = \frac{1 \times 10^6}{5.5499} \approx 180,183 \text{ 時間 (Hours)}$$

## 2. 部品ディレーティング COMPONENT DERATING

MODEL : KS10-5



### (1) 算出方法 Calculating method

#### (a) 測定条件 Condition

- ・ 入力 : 100VAC      ・ 出力 : 5V2A (100%)  
Input                      Output
- ・ 周囲温度 : 50℃      ・ 取付方法 : 標準取付(A)  
Ambient temperature      Mounting Method : Standard Mounting Method (A)

#### (b) 半導体 Semiconductors

周囲温度, 消費電力, 熱抵抗より使用状態の接合点温度を求め最大定格, 接合点温度との比較を求めました。

Compared with maximum junction temperature and actual one which is calculated based on ambient temperature, power dissipation and thermal impedance.

#### (c) IC, 抵抗, コンデンサー等 IC, Resistors, Capacitors, etc.

周囲温度, 使用状態, 消費電力など, 個々の値は設計基準内に入っています。

Ambient temperature, operating condition, power dissipation and so on are within derating criteria.

#### (d) 熱抵抗算出方法 Calculating method of thermal impedance

$$\theta_{j-c} = \frac{T_{j(max)} - T_c}{P_{c(max)}} \quad \theta_{j-a} = \frac{T_{j(max)} - T_a}{P_{c(max)}}$$

$T_c$  : ディレーティングの始まるケース温度 一般に25℃

Case Temperature at Start Point of Derating ; 25℃ in General

$T_a$  : ディレーティングの始まる周囲温度 一般に25℃

Ambient Temperature at Start Point of Derating ; 25℃ in General

$P_{c(max)}$  : 最大コレクタ損失

Maximum Collector Dissipation

$T_{j(max)}$  : 最大接合点温度

Maximum Junction Temperature

$\theta_{j-c}$  : 接合点からケースまでの熱抵抗

Thermal Impedance between Junction and Case

$\theta_{j-a}$  : 接合点から周囲までの熱抵抗

Thermal Impedance between Junction and Air

		Vin=AC100V	LOAD=100%	Ta=50°C
Q1 2SK1769 TOSHIBA	Tchmax= 150 °C Pd = 0.55 W Tch = Tc+(Θch-c)×Pd D.F. = 72.2%	Θch-c= 8.33 °C/W ΔTc = 53.7 °C = 108.3 °C	Pd(max) = 15 W Tc = 103.7 °C	
A1 M51977FP MITSUBISHI	Tjmax = 150 °C Pd = 0.33 W Tj = Tc+(Θj-c)×Pd D.F. = 69.0%	Θj-c = 21.4 °C/W ΔTc = 46.4 °C = 103.5 °C	Pd(max) = 1.5 W Tc = 96.4 °C	
A2 HA17431FPA HITACHI	Tjmax = 150 °C Pd = 0.004 W Tj = Tc+(Θj-c)×Pd D.F. = 55.8%	Θj-c = 259 °C/W ΔTc = 32.5 °C = 83.7 °C	Pd(max) = 0.38 W Tc = 82.5 °C	
PC1 (LED) TLP121GR TOSHIBA	Tjmax = 125 °C If = 0.96 mA ALLOWABLE If D.F. = 1.9%	Θj-c = - °C/W ΔTc = 37.3 °C = 50 mA	Pd(max) = - W Tc = 87.3 °C	
PC1 (TRANSISTOR) TLP121GR TOSHIBA	Tjmax = 125 °C Pd = 0.007 W Tj = Tc+(Θj-c)×Pd D.F. = 72.1%	Θj-c = 400 °C/W ΔTc = 37.3 °C = 90.1 °C	Pd(max) = 0.15 W Tc = 87.3 °C	
D1 S1ZB60 SHINDENGEN	Tjmax = 150 °C Pd = 0.21 W Tj = Tl+(Θj-l)×Pd D.F. = 67.5%	Θj-l = 20 °C/W ΔTl = 47 °C = 101.2 °C	Pd(max) = - W Tl = 97 °C	

TDK-Lambda

SEMICONDUCTOR DERATING

Vin=AC100V

LOAD=100%

Ta=50°C

D2 D1FK40 SHINDENGEN	$T_{jmax} = 150 \text{ } ^\circ\text{C}$ $\Theta_{j-l} = 23 \text{ } ^\circ\text{C/W}$ $P_d = 0.002 \text{ W}$ $\Delta T_l = 50.4 \text{ } ^\circ\text{C}$ $T_j = T_l + (\Theta_{j-l}) \times P_d = 100.4 \text{ } ^\circ\text{C}$ D.F. = 66.9%	$P_d(max) = - \text{ W}$ $T_l = 100.4 \text{ } ^\circ\text{C}$
D3 D1FL20U SHINDENGEN	$T_{jmax} = 150 \text{ } ^\circ\text{C}$ $\Theta_{j-l} = 23 \text{ } ^\circ\text{C/W}$ $P_d = 0.023 \text{ W}$ $\Delta T_l = 43.1 \text{ } ^\circ\text{C}$ $T_j = T_l + (\Theta_{j-l}) \times P_d = 93.6 \text{ } ^\circ\text{C}$ D.F. = 62.4%	$P_d(max) = - \text{ W}$ $T_l = 93.1 \text{ } ^\circ\text{C}$
D4 TP802C04 FUJI ELECT	$T_{jmax} = 150 \text{ } ^\circ\text{C}$ $\Theta_{j-l} = 3 \text{ } ^\circ\text{C/W}$ $P_d = 1.1 \text{ W}$ $\Delta T_l = 58.4 \text{ } ^\circ\text{C}$ $T_j = T_l + (\Theta_{j-l}) \times P_d = 111.7 \text{ } ^\circ\text{C}$ D.F. = 74.5%	$P_d(max) = - \text{ W}$ $T_l = 108.4 \text{ } ^\circ\text{C}$
ZD1 MA1Z062 MATSUSHITA	$T_{jmax} = 150 \text{ } ^\circ\text{C}$ $\Theta_{j-l} = - \text{ } ^\circ\text{C/W}$ $P_d = 0 \text{ W}$ $\Delta T_l = 44.1 \text{ } ^\circ\text{C}$ $T_j = T_l + (\Theta_{j-l}) \times P_d = 94.1 \text{ } ^\circ\text{C}$ D.F. = 62.7%	$P_d(max) = - \text{ W}$ $T_l = 94.1 \text{ } ^\circ\text{C}$

**TDK-Lambda**

ΔT TEMPERATURE RISE

MODEL : KS10

ΔT TEMPERATURE RISE (°C)						
OUTPUT DERATING(%) Ta:50°C		100	100	100	100	100
LOCATION NO.	PARTS NAME	A	B	C	D	E
Q1	MOSFET	53.7	52.2	52.7	52.9	51.8
A1	PWM IC	46.4	46.5	44.5	45.8	44.3
D4	SBD	58.4	55.8	58.9	56.6	58.7
T1	TIMER	52.5	50.2	52.6	51.4	51.1
C4	E. CAP	35.8	36.3	34.2	35.1	34.8
C17	OS E. CAP	46.3	44.6	45.4	44.3	47.0

CONDITION : Ta:50 °C

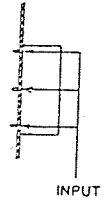
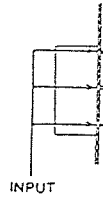
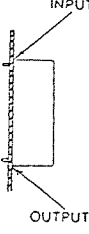
MOUNTING METHOD	A	B	C	D	E
	(STANDARD MOUNTING : A)				
INPUT VOLTAGE (Vac)	100	100	100	100	100
OUTPUT VOLTAGE (V)	5	5	5	5	5
OUTPUT CURRENT (A)	2	2	2	2	2
OUTPUT DERATING (%)	100	100	100	100	100

**TDK-Lambda**

PA758 - 66 - 02

## ELECTROLYTIC CAPACITOR LIFETIME VERSUS LOAD

MODEL : KS10-5

MOUNTING : A

VIN : 100VAC

DATE: SEPT 12, 2008

LOAD (%)	LIFETIME (YRS)				
	Ta = 30°C	Ta = 40°C	Ta = 50°C	Ta = 60°C	Ta = 70°C
25	45.6	16.0	5.6	2.0	0.7
60	17.0	6.0	2.1	0.7	
80	8.9	3.1	1.1		
100	4.6	1.6	0.6		

GRAPH OF ELECTROLYTIC CAPACITOR LIFETIME VS LOAD  
MOUNTING A KS10-5

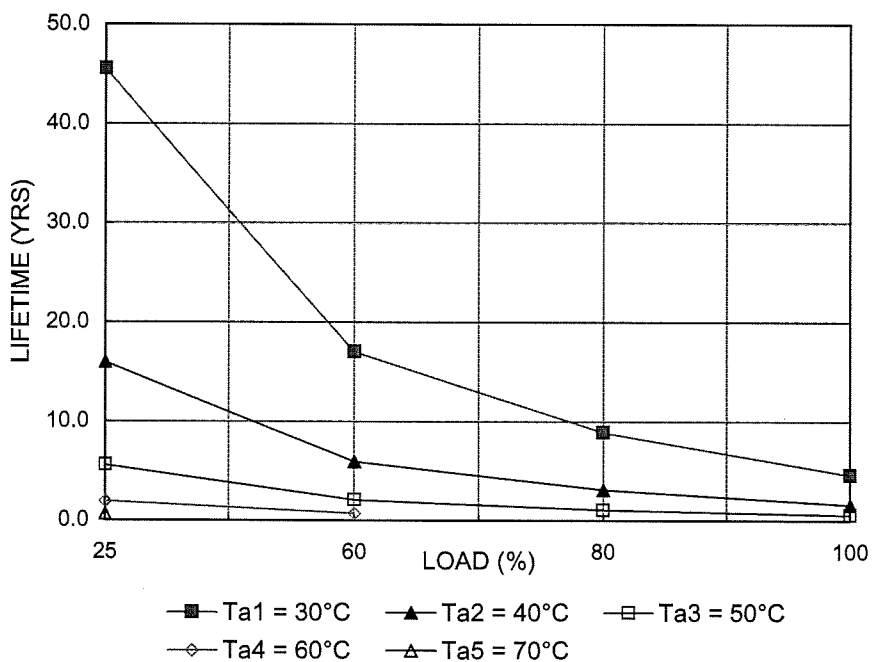

計算式 **FORMULA**

- |                                                                                                             |                                                                                                                                            |
|-------------------------------------------------------------------------------------------------------------|--------------------------------------------------------------------------------------------------------------------------------------------|
| <p>1. アルミ電解コンデンサ<br/>AL. Electrolytic capacitor<br/><math>L = L_0 \times 2^{(105-T_c)/10}</math> (year)</p> | <p>L : 電解コンデンサ推定寿命計算値<br/>Elec. Capacitor computed life.<br/>(24時間連続稼動、365日)<br/>(24 hrs per day, 365 days per year)</p>                   |
| <p>2. OSコンデンサ<br/>O.S capacitor<br/><math>L = L_0 \times 10^{(105-T_c)/22}</math> (year)</p>                | <p>L<sub>0</sub> : 電解コンデンサ保証寿命値<br/>Guarantee life for Elec. cap.<br/>T<sub>c</sub> : 電解コンデンサのケース温度<br/>Case temperature of Elec. cap.</p> |

**TDK-Lambda**



# ELECTROLYTIC CAPACITOR LIFETIME VERSUS LOAD

MODEL : KS10-5

MOUNTING : B

VIN : 100VAC

DATE: SEPT 12, 2008

LOAD (%)	LIFETIME (YRS)				
	Ta = 30°C	Ta = 40°C	Ta = 50°C	Ta = 60°C	Ta = 70°C
25	44.7	17.2	6.0	2.1	0.7
60	21.0	7.4	2.6	0.9	
80	10.6	3.7	1.3		
100	5.5	1.9	0.7		

GRAPH OF ELECTROLYTIC CAPACITOR LIFETIME VS LOAD  
MOUNTING B KS10-5

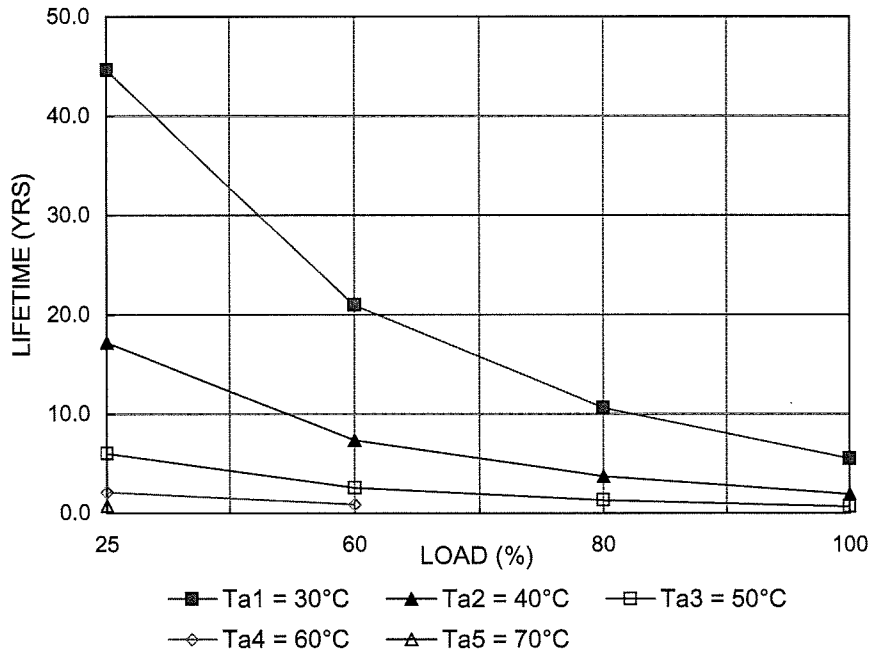

計算式 <u>FORMULA</u>	
1. アルミ電解コンデンサ AL. Electrolytic capacitor $L = L_o \times 2^{(105-T_c)/10}$ (year)	L : 電解コンデンサ推定寿命計算値 Elec. Capacitor computed life. (24時間連続稼動、365日) (24 hrs per day, 365 days per year)
2. OSコンデンサ O.S capacitor $L = L_o \times 10^{(105-T_c)/22}$ (year)	L <sub>o</sub> : 電解コンデンサ保証寿命値 Guarantee life for Elec. cap. T <sub>c</sub> : 電解コンデンサのケース温度 Case temperature of Elec. cap.

# ELECTROLYTIC CAPACITOR LIFETIME VERSUS LOAD

MODEL : KS10-5

MOUNTING : C

VIN : 100VAC

DATE: SEPT 12, 2008

LOAD (%)	LIFETIME (YRS)				
	Ta = 30°C	Ta = 40°C	Ta = 50°C	Ta = 60°C	Ta = 70°C
25	42.8	15.0	5.3	1.9	0.7
60	18.5	6.5	2.3	0.8	
80	9.6	3.4	1.2		
100	5.1	1.8	0.6		

GRAPH OF ELECTROLYTIC CAPACITOR LIFETIME VS LOAD  
MOUNTING C KS10-5

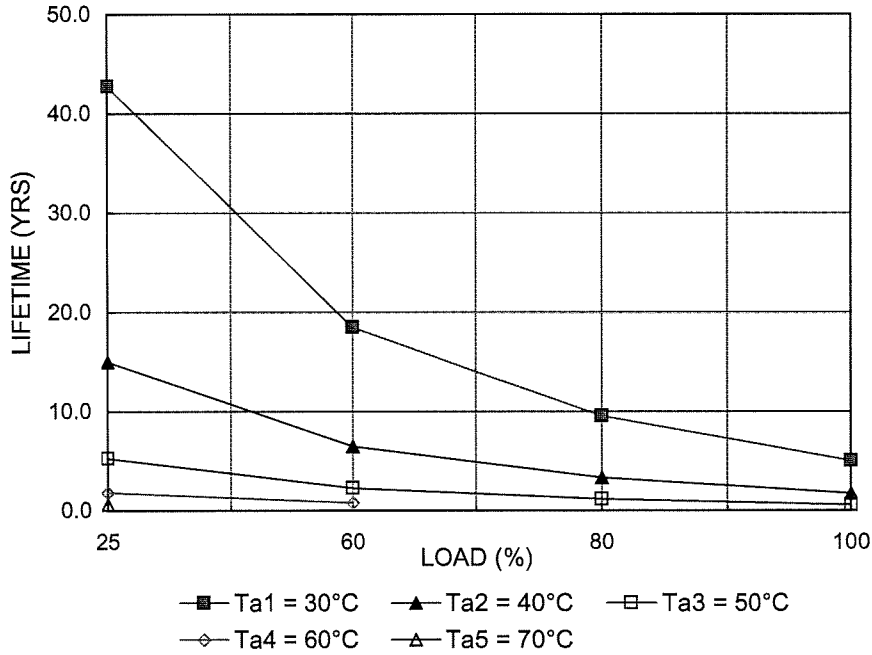

計算式 **FORMULA**

1. アルミ電解コンデンサ  
AL. Electrolytic capacitor  
 $L = L_0 \times 2^{(105-T_c)/10}$  (year)      L : 電解コンデンサ推定寿命計算値  
 Elec. Capacitor computed life.  
 (24時間連続稼動、365日)  
 (24 hrs per day, 365 days per year)

2. OSコンデンサ  
O.S capacitor  
 $L = L_0 \times 10^{(105-T_c)/22}$  (year)      L<sub>0</sub> : 電解コンデンサ保証寿命値  
 Guarantee life for Elec. cap.  
 T<sub>c</sub> : 電解コンデンサのケース温度  
 Case temperature of Elec. cap.

# ELECTROLYTIC CAPACITOR LIFETIME VERSUS LOAD

MODEL : KS10-5

MOUNTING : D

VIN : 100VAC

DATE: SEPT 12, 2008

LOAD (%)	LIFETIME (YRS)				
	Ta = 30°C	Ta = 40°C	Ta = 50°C	Ta = 60°C	Ta = 70°C
25	48.2	17.8	6.2	2.2	0.8
60	19.1	6.7	2.4	0.8	
80	10.4	3.7	1.3		
100	5.7	2.0	0.7		

GRAPH OF ELECTROLYTIC CAPACITOR LIFETIME VS LOAD  
MOUNTING D KS10-5

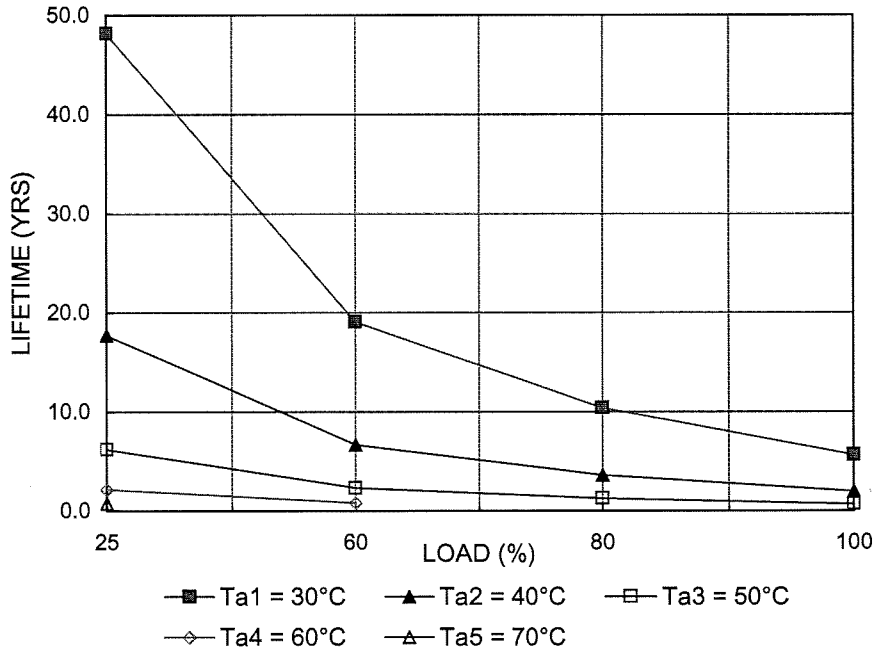

計算式 **FORMULA**

- |                                                                                                             |                                                                                                                                            |
|-------------------------------------------------------------------------------------------------------------|--------------------------------------------------------------------------------------------------------------------------------------------|
| <p>1. アルミ電解コンデンサ<br/>AL. Electrolytic capacitor<br/><math>L = L_o \times 2^{(105-T_c)/10}</math> (year)</p> | <p>L : 電解コンデンサ推定寿命計算値<br/>Elec. Capacitor computed life.<br/>(24時間連続稼動、365日)<br/>(24 hrs per day, 365 days per year)</p>                   |
| <p>2. OSコンデンサ<br/>O.S capacitor<br/><math>L = L_o \times 10^{(105-T_c)/22}</math> (year)</p>                | <p>L<sub>o</sub> : 電解コンデンサ保証寿命値<br/>Guarantee life for Elec. cap.<br/>T<sub>c</sub> : 電解コンデンサのケース温度<br/>Case temperature of Elec. cap.</p> |

**TDK-Lambda**

# ELECTROLYTIC CAPACITOR LIFETIME VERSUS LOAD

MODEL : KS10-5

MOUNTING : E

VIN : 100VAC

DATE: SEPT 12, 2008

LOAD (%)	LIFETIME (YRS)				
	Ta = 30°C	Ta = 40°C	Ta = 50°C	Ta = 60°C	Ta = 70°C
25	37.7	13.2	4.65	1.63332024	0.57349005
60	15.7	5.5	1.93	0.7	
80	8.2	2.9	1.01		
100	4.3	1.5	0.53		

GRAPH OF ELECTROLYTIC CAPACITOR LIFETIME VS LOAD  
MOUNTING E KS10-5

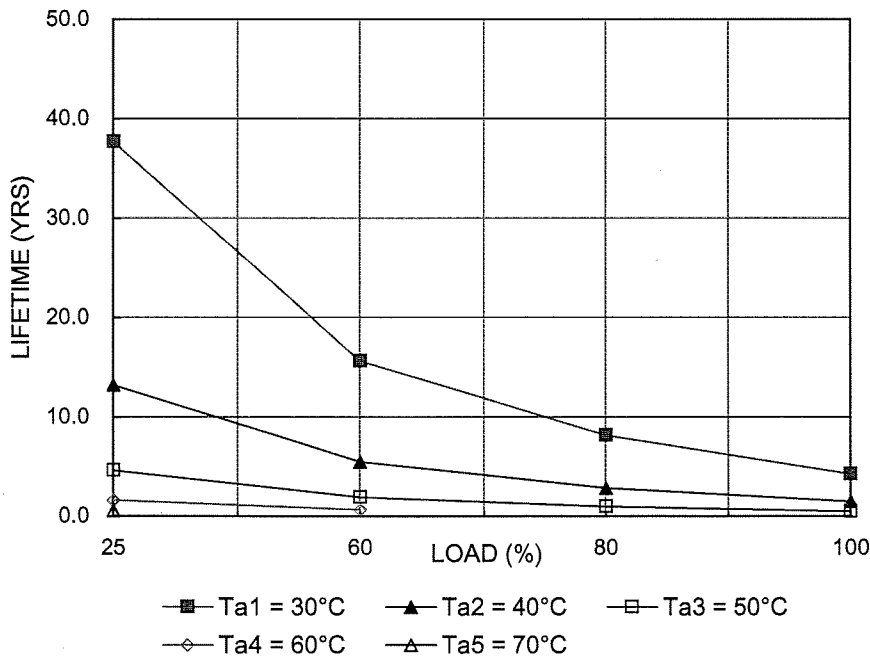

計算式 **FORMULA**

1. アルミ電解コンデンサ  
AL. Electrolytic capacitor  
 $L = L_o \times 2^{(105-T_c)/10}$  (year)      L : 電解コンデンサ推定寿命計算値  
 Elec. Capacitor computed life.  
 (24時間連続稼動、365日)  
 (24 hrs per day, 365 days per year)

2. OSコンデンサ  
O.S capacitor  
 $L = L_o \times 10^{(105-T_c)/22}$  (year)      L<sub>o</sub> : 電解コンデンサ保証寿命値  
 Guarantee life for Elec. cap.  
 T<sub>c</sub> : 電解コンデンサのケース温度  
 Case temperature of Elec. cap.

**TDK-Lambda**

MODEL : KS10-5		ABNORMAL TESTING										TEST CONDITIONS		TESTED BY										
												LOAD = 100 %		DATE										
												Vin = 100VAC		17/MAR/92										
												Ta = 25°C		Stage										
PARTS NAME	PART NO.	TEST MODE										TEST RESULTS												
		SHORT	OPEN	FIRE	SMOKE a	SMOKE b	BURST	SMELL	RED HOT	DAMAGE	FUSION	OV	OC	NO	CH	AN	GE	OTHERS	NOTE	OK	TEST			
MOSFET	Q1		Y																R9,R12,R13,R14,R15 OPEN; Q1 SHORTED	Y				
2SK1769			Y																R9,R12,R13,R14,R15 OPEN; Q1 SHORTED	Y				
			Y																	Y				
				Y																	Y			
				Y																	Y			
				Y																	Y			
				Y																	Y			
CHIP IC	A1		Y																R5,R6, GRADUALLY OPEN, THEN NO OUTPUT	Y				
M51977FP			Y																	Y				
			Y																	Y				
			Y																	Y				
			Y																	Y				
			Y																	Y				
			Y																	Y				
			Y																	Y				
			Y																	Y				
			Y																	Y				
			Y																	Y				
			Y																	Y				
			Y																	Y				
			Y																	Y				
			Y																	Y				
			Y																	Y				
			Y																	Y				
			Y																	Y				
			Y																	Y				
			Y																	Y				
			Y																	Y				
			Y																	Y				
			Y																	Y				
			Y																	Y				
			Y																	Y				
			Y																	Y				
			Y																	Y				
			Y																	Y				
			Y																	Y				
			Y																	Y				
			Y																	Y				
			Y																	Y				
			Y																	Y				
			Y																	Y				
			Y																	Y				
			Y																	Y				
			Y																	Y				
			Y																	Y				
			Y																	Y				
			Y																	Y				
			Y																	Y				
			Y																	Y				
			Y																	Y				
			Y																	Y				
			Y																	Y				
			Y																	Y				
			Y																	Y				
			Y																	Y				
			Y																	Y				
			Y																	Y				
			Y																	Y				
			Y																	Y				
			Y																	Y				
			Y																	Y				
			Y																	Y				
			Y																	Y				
			Y																	Y				
			Y																	Y				
			Y																	Y				
			Y																	Y				
			Y																	Y				
			Y																	Y				
			Y																	Y				
			Y																	Y				
			Y																	Y				
			Y																	Y				
			Y																	Y				
			Y																	Y				
			Y																	Y				
			Y																	Y				
			Y																	Y				
			Y																	Y				
			Y																	Y				
			Y																	Y				
			Y																	Y				
			Y																	Y				
			Y																	Y				
			Y																	Y				
			Y																	Y				
			Y																	Y				
		</																						













## 6. 振動試験 VIBRATION TEST

MODEL : KS10-5

- (1) 振動試験種類 Vibration test class  
 掃引振動数耐久試験 Frequency variable endurance test
- (2) 使用振動試験装置 Equipment used  
 新日本測器株式会社 制御部 F-400-BM-E47  
 SHIN-NIPPON Controller  
 SOKKI Co., LTD
- 加振部 905-FN  
 Vibrator
- (3) 試験方法 Testing method

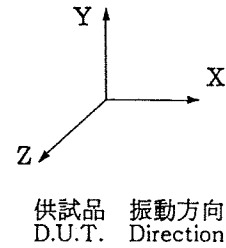
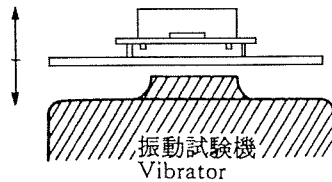

- 可変周波数振動試験
- ・周波数範囲 10~55Hz  
Sweep frequency
  - ・掃引時間 1分間  
Sweep time 1 min.
  - ・振幅 一定 (1.65mm)  
Amplitude const.
  - ・振幅方向 X, Y, Z.  
Direction
  - ・試験時間 各方向共 1 H  
Test time 1H each

(4) 試験結果 Result

合格 不合格  
 OK NG

測定確認項目 Check item	出力電圧 (V) Vout	リップル (mVp-p) Ripple (mVp-p)	機能・実装状態 D. U. T. state	備考 Note
試験前 Initial 振動方向 Directions	5.013	22	異常なし OK	
X	5.012	22	異常なし OK	
Y	5.012	24	異常なし OK	
Z	5.014	22	異常なし OK	

# 7. ノイズシミュレート試験 NOISE SIMULATE TEST

MODEL : KS10

## (1) 測定回路及び測定機 Test circuit and equipment

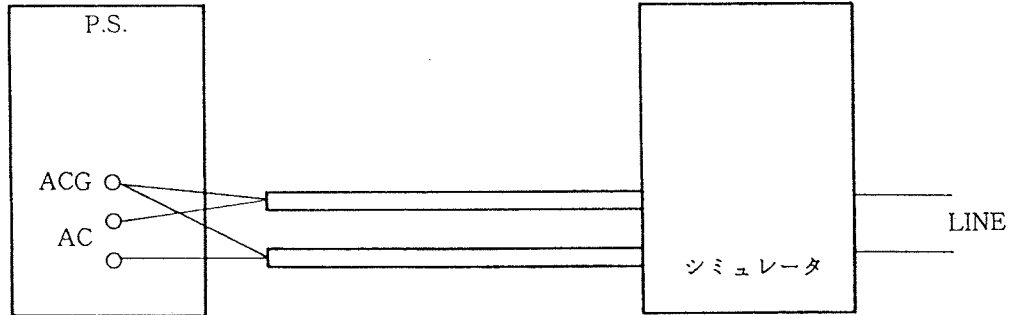

シミュレータ : ENS-24X (三基電子工業株)  
simulator (SANKI E. IND)

## (2) 測定条件 Measuring Conditions

- ・入力電圧：定格  
Input voltage Rated
- ・出力電圧：定格  
Output voltage Rated
- ・出力電流：0%, 100%  
Output Current
- ・電源周囲温度：25℃  
Ambient temperature
- ・パルス幅：50ns~1000ns  
Pulse width
- ・ノイズ電圧：0~2kV  
Noise level
- ・位相：0~360°  
Phase shift
- ・極性：+, -  
Polarity
- ・MODE : NORMAL, COMMON
- ・TRIG SELECT : LINE

## (3) 判定条件 Acceptable conditions

- 1. 破壊しない事 Not to be broken
- 2. 出力がダウンしない事 Not to be shut down output
- 3. その他異常のない事 No other out of orders

## (4) 試験結果 Results

- 合格 不合格
- OK NG

## 8. 静電気シミュレーション試験 ELECTRO-STATIC DISCHARGE TEST

MODEL : KS10

(1) 使用計測器 Equipment used

SET-30E (三基電子工業(株))

(SANKI. E. IND.)

放電抵抗 : 250Ω      静電容量 : 200pF

Discharge resistance      Capacity

(2) 測定条件 Measuring conditions

・入力電圧 : 定格      ・出力電圧 : 定格      ・出力電流 : 定格

Input voltage : Rated      Output voltage : Rated      Output current : Rated

・電源周囲温度 : 25℃      ・印加電圧 : ±3KV, ±5KV, ±10KV, ±15KV

Ambient temperature      Test voltage

(3) 試験方法 Testing method

被試験電源を稼働状態にしておき、露出部分で人体がふれる可能性のある部分（ケース，入力端子，出力端子，FG端子，ACG端子）に放電をさせ、出力に異常の無い事を確認する。

尚、試験回数は、+，-各3回とし、引加電圧は3KVから15KVまで順次上げていくものとする。Check if there is no abnormal output when the testing voltage is applied to operating D. U. T. (Device Under Test) on its case, input terminal, output terminal, FG terminal and ACG terminal which are exposed parts to human body. Testing cycle is at +, - for three times each, and the applied voltage to be gradually increased from 3KV to 15KV.

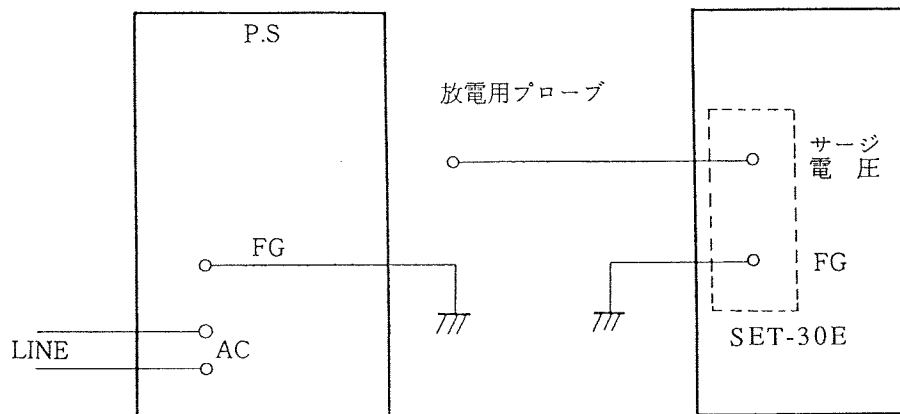

(4) 判定条件 Acceptable conditions

- |                 |                            |
|-----------------|----------------------------|
| 1. 破壊しない事       | Not to be broken           |
| 2. 出力電圧がダウンしない事 | Not to be shut down output |
| 3. その他異常の無いこと   | No other out of orders     |

(5) 試験結果 Result

合格                      不合格  
 OK                              NG

9. 雷サージ試験 IMPULSE TEST

MODEL : KS10

(1) 使用計測器 Equipment used

LSG-12K-E (三基電子工業(株))  
(SANKI. E. IND.)

(2) 測定条件 Measuring conditions

- |                                       |                                            |
|---------------------------------------|--------------------------------------------|
| ・入力電圧：定格<br>Input voltage : Rated     | ・印加電圧：5kV<br>Test voltage                  |
| ・出力電圧：定格<br>Output voltage : Rated    | ・印加箇所：FG-AC間<br>Test point : Between FG-AC |
| ・出力電流：無負荷<br>Output current : No load | ・試験回数：3回<br>Test time : 3 times            |
| ・電源周囲温度：25℃<br>Ambient temperature    | ・極性：+，-<br>Polarity                        |

(3) 試験方法 Testing method

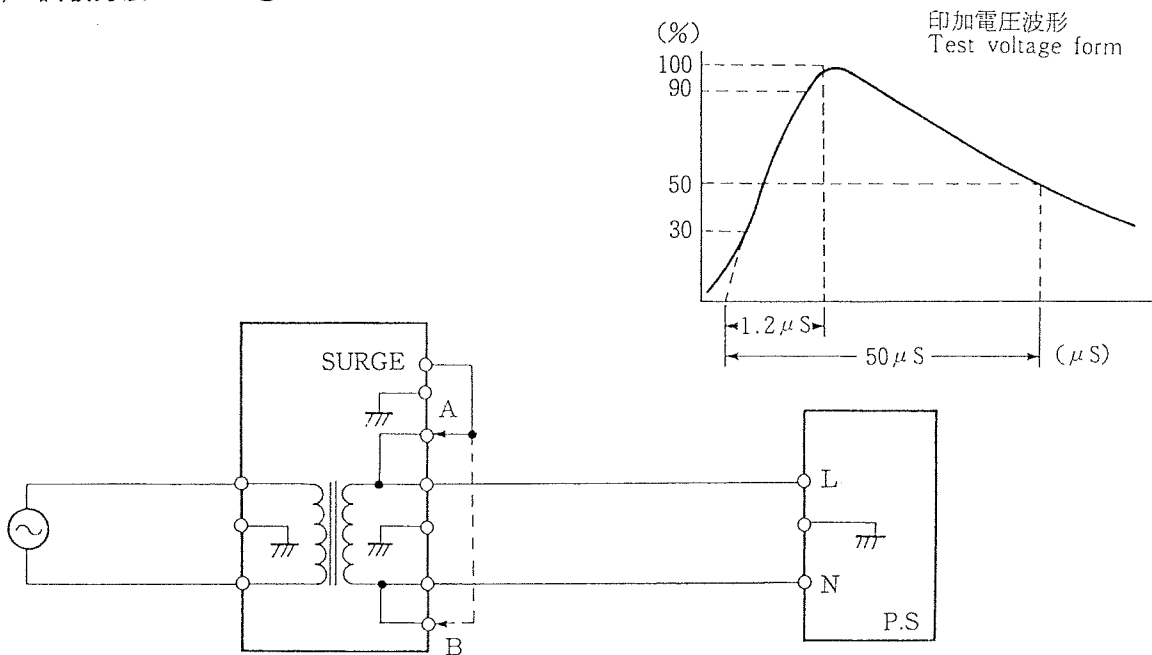

(4) 判定条件 Acceptable conditions

- |                 |                            |
|-----------------|----------------------------|
| 1. 破壊しない事       | Not to be broken           |
| 2. 出力電圧がダウンしない事 | Not to be shut down output |
| 3. その他異常の無いこと   | No other out of orders     |

(5) 試験結果 Result

- |    |     |
|----|-----|
| 合格 | 不合格 |
| OK | NG  |

EMI TEST

TEST CIRCUIT :

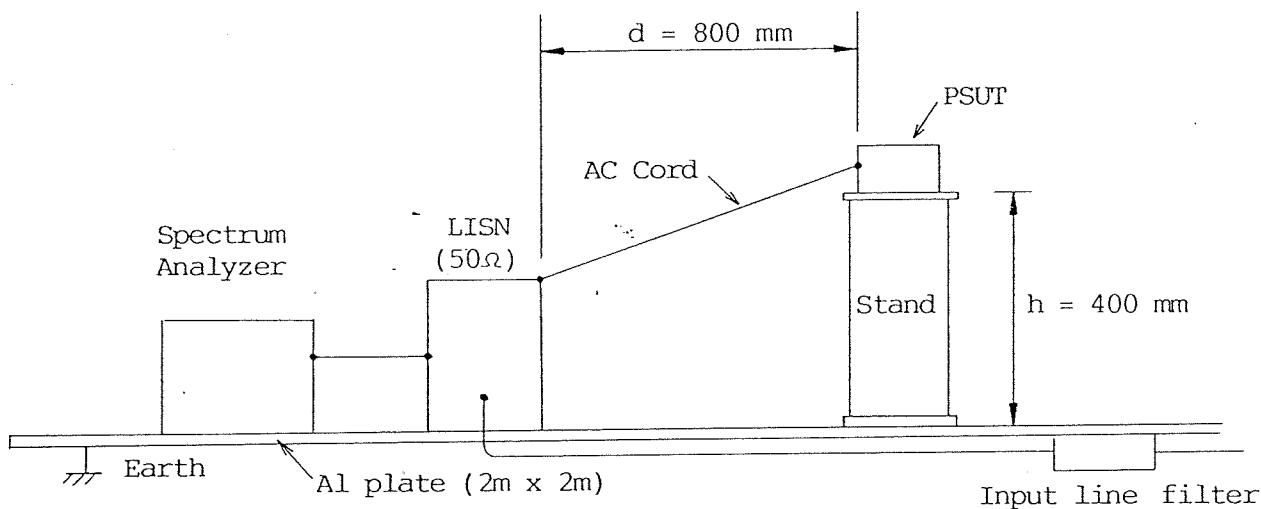

TEST EQUIPMENTS :

SPECTRUM ANALYZER	8568B	HEWLETT PACKARD
QUASI-PEAK ADAPTER	85650A	HEWLETT PACKARD
RF PRESELECTOR	85685A	HEWLETT PACKARD
LISN	3825/2	EMCO

CONDITIONS :

INPUT VOLTAGE	:	AC 100V
OUTPUT VOLTAGE	:	RATED
OUTPUT CURRENT	:	RATED
AMBIENT TEMP.	:	25°C

認 APPD	<i>[Signature]</i> 8. APR. '92	設 計 ENGR	SY Um 8. 4. 1992	図面番号 DWG-No.	PA758-71-01- <span style="border: 1px dashed black; display: inline-block; width: 20px; height: 20px; vertical-align: middle;"></span>
検 査 CHK	<i>[Signature]</i> 8. APR. '92	製 図 DWG	SY Um 8. 4. 1992		

KS10 - 5

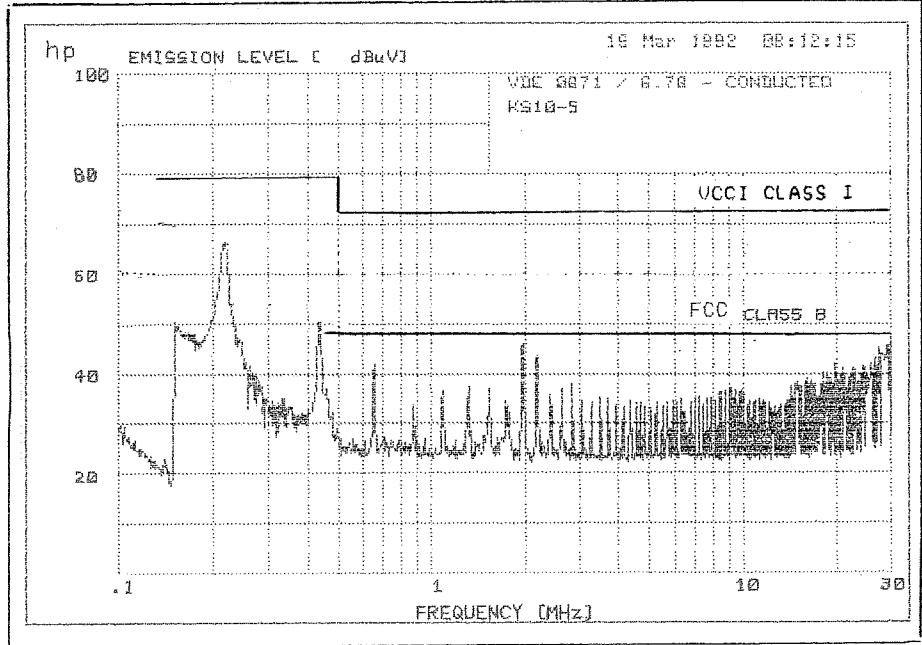

KS10 - 12

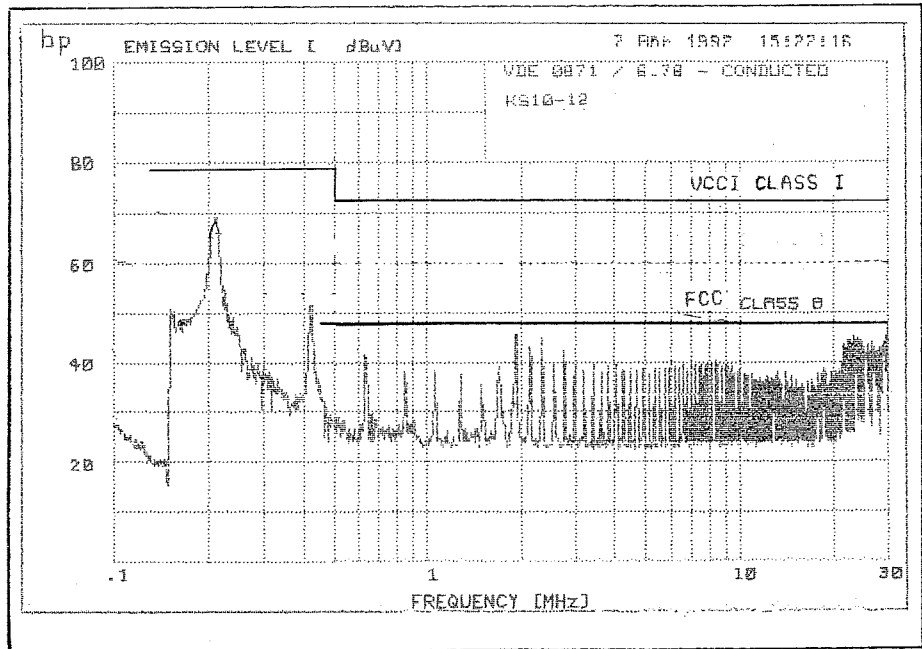

認 APPD	.	設 計 ENGR	.	図面番号 DWG - No. PA758-71-02- <input type="checkbox"/>
検 図 CHK	.	製 図 DWG	.	