

LS25

RELIABILITY DATA

DWG. No PA580-57-01		
APPD	CHK	DWG
<i>Jeff</i> 5-Jan-09	<i>Ramona</i> 5-Jan-09	<i>At.</i> 5-Jan-09

I N D E X

	PAGE
1. Calculated Values of MTBF	R - 1
2. Component Derating	R - 2
3. Main Components Temperature Rise ΔT List	R - 5
4. Electrolytic Capacitor Life	R - 7
5. Vibration Test	R - 11
6. Noise Simulate Test	R - 12
7. Abnormal Test	R - 13
8. Thermal Shock Test	R - 15

※ The above data is typical value. As all units have nearly the same characteristics, the data to be considered as ability value.

1. Calculated values for MTBF

MODEL : LS25-5

1. Calculating Method

Calculated based on part count reliability projection of JEITA (RCR-9102).

Individual failure rates λ_G is given to each part and MTBF is calculated by the count of each part.

Formula :

$$\begin{aligned}
 \text{MTBF} &= \frac{1}{\lambda_{\text{equip}}} \\
 &= \frac{1}{\sum_{i=1}^n N_i (\lambda_G \pi_Q)_i} \times 10^6 \text{ (HOURS)}
 \end{aligned}$$

where :

λ_{equip} = Total Equipment Failure Rate (Failure / 10^6 Hours)

λ_G = Generic Failure Rate For The ith Generic Part (Failure / 10^6 Hours)

N_i = Quantity of ith Generic Part

n = Number of Different Generic Part Categories

π_Q = Generic Quality Factor for the ith Generic Part ($\pi_Q = 1$)

2. MTBF Values

G_F : (GROUND, FIXED)

MTBF = 906,997 (Hours)

2. Component derating

MODEL : LS25-5

(1) Calculating method

(a) Measuring Conditions

Input	: 115 , 230VAC	• Ambient temperature	: 50°C
Output	: 5V 5A(100%)	• Mounting method	: Mounting A

(b) Semiconductors

Compared with maximum junction temperature and actual one which is calculated based on case temperature, power dissipation and thermal impedance.

(c) IC, Resistors, Capacitors, etc.

Ambient temperature, operating condition, power dissipation and so on are within derating criteria.

(d) Calculating Method of Thermal Impedance

$$\theta_{j-c} = \frac{T_{j(\max)} - T_c}{P_{c(\max)}} \quad \theta_{j-a} = \frac{T_{j(\max)} - T_a}{P_{c(\max)}} \quad \theta_{j-l} = \frac{T_{j(\max)} - T_l}{P_{c(\max)}}$$

T_c : Case temperature at start point of derating ; 25°C in general

T_a : Ambient temperature at start point of derating ; 25°C in general

T_j : Lead temperature at start point of derating ; 25°C in general

$P_{c(\max)}$: Maximum collector(channel) dissipation
($P_{ch(\max)}$)

$T_{j(\max)}$: Maximum junction(channel) temperature
($T_{ch(\max)}$)

(θ_{j-c}) : Thermal impedance between junction(channel) and case
(θ_{ch-c})

θ_{j-a} : Thermal impedance between junction and air

θ_{j-l} : Thermal impedance between junction and lead

(2) Component Derating List

Location No.	$V_{in} = 115VAC$ $Load = 100\%$ $T_a = 50^{\circ}C$
D1 S1VB60-7000 SHINDENGEN	$T_{jmax} = 150^{\circ}C$, $\theta_{j-l} = 16^{\circ}C/W$, $P_d = 0.44W$, $\Delta T_c = 34.7^{\circ}C$, $T_j = T_c + ((\theta_{j-l}) \times P_d) = 91.74^{\circ}C$ $D.F. = 61.16\%$
D2 CRF02(TE85L,Q) TOSHIBA	$T_{jmax} = 150^{\circ}C$, $\theta_{j-c} = 140^{\circ}C/W$, $P_d = 53mW$, $\Delta T_c = 67.1^{\circ}C$, $T_j = T_c + ((\theta_{j-c}) \times P_d) = 124.52^{\circ}C$ $D.F. = 83.01\%$
D3 CRH01(TE85L,Q) TOSHIBA	$T_{jmax} = 150^{\circ}C$, $\theta_{j-c} = 130^{\circ}C/W$ $P_d = 1mW$, $\Delta T_c = 36.8^{\circ}C$ $T_j = T_c + ((\theta_{j-c}) \times P_d) = 86.81^{\circ}C$ $D.F. = 57.87\%$
D4 STPS20L45CFP ST MICROELECTRONICS	$T_{jmax} = 150^{\circ}C$, $\theta_{j-c} = 3.5^{\circ}C/W$ $P_d = 2.5W$, $\Delta T_l = 63.0^{\circ}C$ $T_j = T_l + ((\theta_{j-c}) \times P_d) = 121.75^{\circ}C$ $D.F. = 81.17\%$
PC1 PS2561BL1-1-A(D) (TRANSISTOR) NEC	$T_{jmax} = 125^{\circ}C$, $\theta_{j-c} = 150^{\circ}C/W$, $P_c = 0.42mW$, $\Delta T_c = 42.9^{\circ}C$, $T_j = T_c + ((\theta_{j-c}) \times P_c) = 92.96^{\circ}C$ $D.F. = 74.37\%$
PC1 PS2561BL1-1-A(D) (LED) NEC	$T_{jmax} = 125^{\circ}C$, $\theta_{j-c} = 150^{\circ}C/W$, $P_c = 1.67mW$, $\Delta T_c = 42.9^{\circ}C$, $T_j = T_c + ((\theta_{j-c}) \times P_c) = 93.15^{\circ}C$ $D.F. = 74.52\%$
A1 MIP2G50MDSLJ PANASONIC	$T_{jmax} = 150^{\circ}C$, $\theta_{j-c} = 3^{\circ}C/W$ $P_d = 1.0438W$, $\Delta T_c = 43.1^{\circ}C$ $T_j = T_c + ((\theta_{j-c}) \times P_d) = 96.23^{\circ}C$ $D.F. = 64.15\%$
A2 HA17431UA-TL-E RENESAS	$T_{jmax} = 150^{\circ}C$, $\theta_{j-c} = 156.25^{\circ}C/W$, $P_d = 5.5mW$, $\Delta T_c = 38.1^{\circ}C$, $T_j = T_c + ((\theta_{j-c}) \times P_d) = 88.95^{\circ}C$ $D.F. = 59.30\%$
PD1 264-7GVD/S530-E2 EVERLIGHT	$IF = 6.4mA$, $\Delta T_c = 27.5^{\circ}C$ Allowable $IF(max) = 10mA$ (at $T_a = 77.5^{\circ}C$) $D.F. = 64\%$

Component Derating List

Location No.	$V_{in} = 230VAC$	Load = 100%	$T_a = 50^{\circ}C$
D1 S1VB60-7000 SHINDENGEN	$T_{jmax} = 150^{\circ}C,$ $P_d = 0.27259W,$ $T_j = T_c + ((\theta_{j-l}) \times P_d) = 84.96^{\circ}C$ D.F. = 56.64%	$\theta_{j-l} = 16^{\circ}C/W,$ $\Delta T_c = 30.6^{\circ}C,$	$T_c = 80.6^{\circ}C$
D2 CRF02(TE85L,Q) TOSHIBA	$T_{jmax} = 150^{\circ}C,$ $P_d = 47.2mW,$ $T_j = T_c + ((\theta_{j-c}) \times P_d) = 116.81^{\circ}C$ D.F. = 77.87%	$\theta_{j-c} = 140^{\circ}C/W,$ $\Delta T_c = 60.2^{\circ}C,$	$T_c = 110.2^{\circ}C$
D3 CRH01(TE85L,Q) TOSHIBA	$T_{jmax} = 150^{\circ}C,$ $P_d = 0.63mW,$ $T_j = T_c + ((\theta_{j-c}) \times P_d) = 82.88^{\circ}C$ D.F. = 55.25%	$\theta_{j-c} = 130^{\circ}C/W$ $\Delta T_c = 32.8^{\circ}C$	$T_c = 82.8^{\circ}C$
D4 STPS20L45CFP ST MICROELECTRONICS	$T_{jmax} = 150^{\circ}C,$ $P_d = 2.5W,$ $T_j = T_l + ((\theta_{j-c}) \times P_d) = 113.15^{\circ}C$ D.F. = 75.43%	$\theta_{j-c} = 3.5^{\circ}C/W$ $\Delta T_l = 54.4^{\circ}C$	$T_l = 104.4^{\circ}C$
PC1 PS2561BL1-1-A(D) (TRANSISTOR) NEC	$T_{jmax} = 125^{\circ}C,$ $P_c = 0.42mW,$ $T_j = T_c + ((\theta_{j-c}) \times P_c) = 87.86^{\circ}C$ D.F. = 70.29%	$\theta_{j-c} = 150^{\circ}C/W,$ $\Delta T_c = 37.8^{\circ}C,$	$P_c(max) = 0.15W$ $T_c = 87.8^{\circ}C$
PC1 PS2561BL1-1-A(D) (LED) NEC	$T_{jmax} = 125^{\circ}C,$ $P_c = 1.76mW,$ $T_j = T_c + ((\theta_{j-c}) \times P_c) = 88.06^{\circ}C$ D.F. = 70.45%	$\theta_{j-c} = 150^{\circ}C/W,$ $\Delta T_c = 37.8^{\circ}C,$	$P_c(max) = 0.15W$ $T_c = 87.8^{\circ}C$
A1 MIP2G50MDSLJ PANASONIC	$T_{jmax} = 150^{\circ}C,$ $P_d = 1.0885W,$ $T_j = T_c + ((\theta_{j-c}) \times P_d) = 93.166^{\circ}C$ D.F. = 62.11%	$\theta_{j-c} = 3^{\circ}C/W$ $\Delta T_c = 39.9^{\circ}C$	$T_c = 89.9^{\circ}C$
A2 HA17431UA-TL-E RENESAS	$T_{jmax} = 150^{\circ}C,$ $P_d = 5.9mW,$ $T_j = T_c + ((\theta_{j-c}) \times P_d) = 83.714^{\circ}C$ D.F. = 55.81%	$\theta_{j-c} = 156.25^{\circ}C/W,$ $\Delta T_c = 32.8^{\circ}C,$	$T_c = 82.8^{\circ}C$
PD1 264-7GVD/S530-E2 EVERLIGHT	$I_F = 6.4 mA,$ Allowable $I_F(max) = 10mA$ (at $T_a = 76.8^{\circ}C$) D.F. = 64%	$\Delta T_c = 26.8^{\circ}C$	$T_c = 76.8^{\circ}C$

3. Main components temperature rise ΔT list

MODEL : LS25-5

Condition:

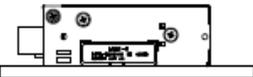
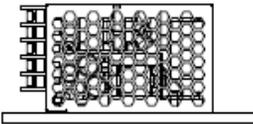
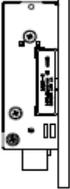
Standard Mounting (Mounting Method (A))	(A)				
					
	Mounting A	Mounting B	Mounting C	Mounting D	
	Input Voltage (VAC)	115			
	Output Voltage (VDC)	5			
Output Current (A)	5				

Output Derating $T_a = 50^\circ\text{C}$		ΔT Temperature rise ($^\circ\text{C}$)			
		$I_o=100\%$	$I_o=100\%$	$I_o=80\%$	$I_o=100\%$
Location No	Parts Name	Mounting (A)	Mounting (B)	Mounting (C)	Mounting (D)
T_a	AMBIENT	28.9	29.4	32.3	31.4
CHASSIS	CHASSIS	48.0	24.6	38.0	48.2
PCB	PRI SNUBBER	58.5	59.3	46.7	62.6
PCB	SEC SNUBBER	48.6	46.5	37.7	48.8
L1	LINE FILTER	40.4	46.2	31.5	41.4
L2	O/P CHOKE	52.1	51.4	41.9	50.8
F1	FUSE	21.8	31.3	22.0	22.6
TH1	THERMISTOR	43.8	46.9	36.6	41.8
R17	DUMMY LOAD	38.0	41.6	29.3	41.1
T1 (CORE)	TRANSFORMER	45.8	40.1	34.7	47.3
T1 (COIL)	TRANSFORMER	47.3	42.4	35.5	47.8
D1	BRIDGE DIODE	34.7	35.8	31.1	32.3
D4	OUTPUT DIODE	63.0	55.9	50.2	62.4
Z1	TVS	46.9	45.5	36.5	46.6
A1	I.C. (MOSFET)	43.1	36.4	32.3	50.0
A2	SHUNT REGULATOR	38.1	37.1	32.5	37.5
PC1	PHOTOCOUPLER	42.9	40.0	33.2	45.7
PD1	LED	27.5	28.9	34.3	29.2
C1	X CAP	33.4	37.9	28.2	32.6
C2	Y CAP	20.2	32.9	19.4	25.3
C3	Y CAP	29.9	37.7	25.1	33.6
C4	CAP. ELECT.	26.3	29.8	20.2	34.2
C12	CAP. ELECT.	48.1	44.2	36.6	46.8
C13	CAP. ELECT.	42.6	40.6	33.6	40.4
C14	CAP. ELECT.	34.9	33.8	29.0	32.0

3. Main components temperature rise ΔT list

MODEL : LS25-5

Condition:

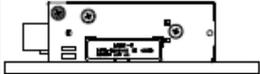
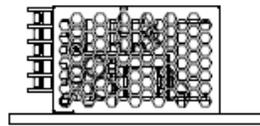
Standard Mounting (Mounting Method (A))	(A)			
				
	Mounting A	Mounting B	Mounting C	Mounting D
Input Voltage (VAC)	230			
Output Voltage (VDC)	5			
Output Current (A)	5			

Output Derating $T_a = 50^\circ\text{C}$		ΔT Temperature rise ($^\circ\text{C}$)			
		$I_o=100\%$	$I_o=100\%$	$I_o=80\%$	$I_o=100\%$
Location No	Parts Name	Mounting (A)	Mounting (B)	Mounting (C)	Mounting (D)
T_a	AMBIENT	30.6	29.5	32.3	32.6
CHASSIS	CHASSIS	41.5	23.8	38.2	46.2
PCB	PRI SNUBBER	54.6	56.0	46.0	59.6
PCB	SEC SNUBBER	42.0	44.9	38.4	46.4
L1	LINE FILTER	26.6	36.1	25.6	30.5
L2	O/P CHOKE	44.0	49.4	41.6	48.6
F1	FUSE	15.8	25.3	18.0	17.4
TH1	THERMISTOR	27.7	35.5	27.0	29.3
R17	DUMMY LOAD	24.3	33.0	22.5	29.8
T1 (CORE)	TRANSFORMER	40.6	39.8	36.6	45.4
T1 (COIL)	TRANSFORMER	41.7	41.7	37.2	45.8
D1	BRIDGE DIODE	30.6	34.6	30.9	31.1
D4	OUTPUT DIODE	54.4	53.9	50.1	59.7
Z1	TVS	40.1	43.5	36.8	43.9
A1	I.C. (MOSFET)	39.9	36.8	36.1	48.7
A2	SHUNT REGULATOR	32.8	35.4	32.5	35.7
PC1	PHOTOCOUPLER	37.8	39.1	34.5	43.5
PD1	LED	26.8	27.9	34.3	28.4
C1	X CAP	25.7	33.6	25.8	27.8
C2	Y CAP	14.8	27.6	16.2	19.8
C3	Y CAP	22.8	33.8	22.6	27.9
C4	CAP. ELECT.	20.0	26.0	18.2	28.2
C12	CAP. ELECT.	40.6	41.9	36.5	43.6
C13	CAP. ELECT.	35.3	38.0	33.0	37.1
C14	CAP. ELECT.	29.5	32.3	28.6	30.2

4. Electrolytic capacitor lifetime

MODEL : LS25-5

Mounting A

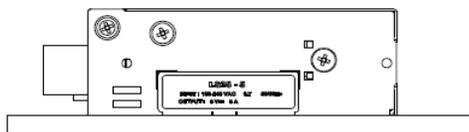

Ta = 40°C ———
 = 50°C - - - - -
 = 70°C

Vin = 115VAC

Load (%)	Life Time (years)		
	Ta = 40°C	Ta = 50°C	Ta = 70°C
50	10.0	10.0	3.0
60	10.0	9.0	2.2
70	10.0	6.6	-
80	9.4	4.7	-
90	6.6	3.3	-
100	4.3	2.2	-

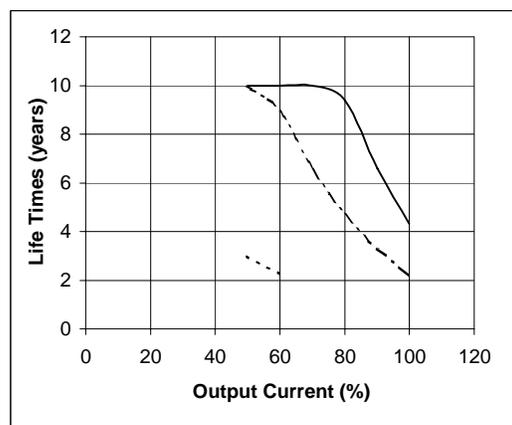

Vin = 230VAC

Load (%)	Life Time (years)		
	Ta = 40°C	Ta = 50°C	Ta = 70°C
50	10.0	10.0	3.7
60	10.0	10.0	2.7
70	10.0	8.1	-
80	10.0	6.2	-
90	9.3	4.6	-
100	9.3	4.6	-

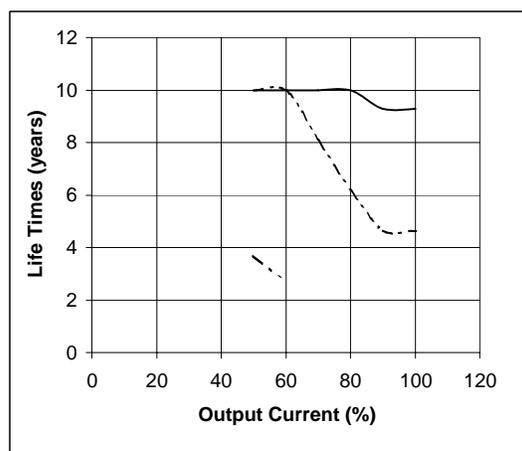

Note : E-cap life calculation is based on 8hrs/day operation.

4. Electrolytic capacitor lifetime

MODEL : LS25-5

Ta = 40°C ———
 = 50°C - - - - -
 = 70°C

Mounting B

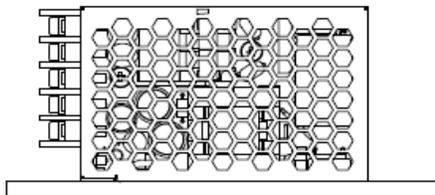

Vin = 115VAC

Load (%)	Life Time (years)		
	Ta = 40°C	Ta = 50°C	Ta = 70°C
50	10.0	10.0	3.0
60	10.0	9.0	2.2
70	10.0	6.7	-
80	9.9	4.9	-
90	7.0	3.5	-
100	4.7	2.4	-

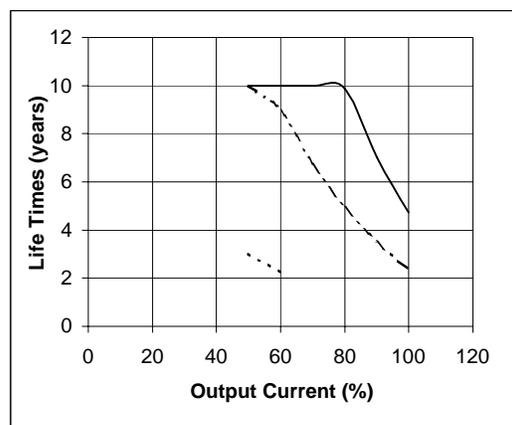

Vin = 230VAC

Load (%)	Life Time (years)		
	Ta = 40°C	Ta = 50°C	Ta = 70°C
50	10.0	10.0	3.6
60	10.0	10.0	2.6
70	10.0	8.4	-
80	10.0	6.5	-
90	9.8	4.9	-
100	7.5	3.8	-

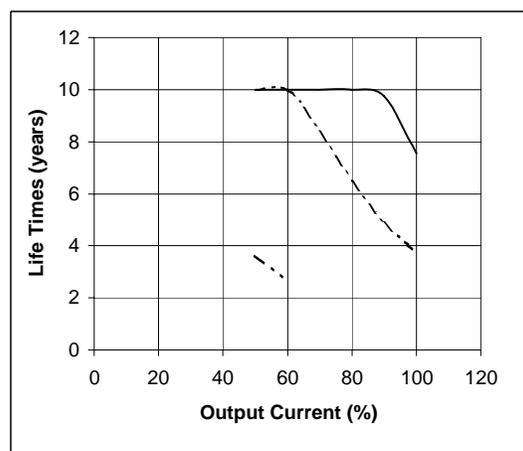

Note : E-cap life calculation is based on 8hrs/day operation.

4. Electrolytic capacitor lifetime

MODEL : LS25-5

Mounting C

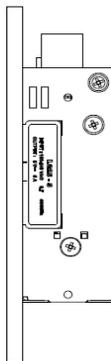

Ta = 40°C ———
 = 50°C - - - - -
 = 70°C

Vin = 115VAC

Load (%)	Life Time (years)		
	Ta = 40°C	Ta = 50°C	Ta = 70°C
50	10.0	10.0	3.0
60	10.0	9.0	-
70	10.0	6.6	-
80	9.6	4.8	-
90	6.8	-	-
100	4.5	-	-

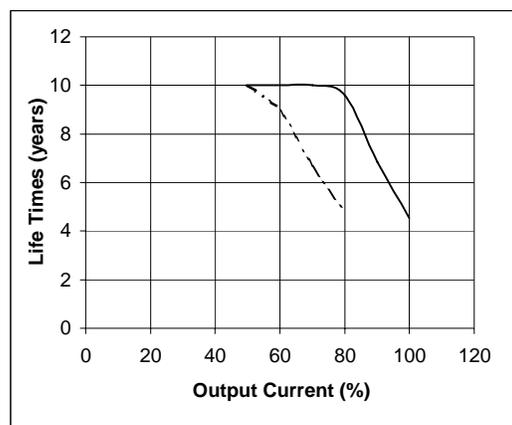

Vin = 230VAC

Load (%)	Life Time (years)		
	Ta = 40°C	Ta = 50°C	Ta = 70°C
50	10.0	10.0	3.6
60	10.0	10.0	-
70	10.0	8.0	-
80	10.0	6.2	-
90	9.3	-	-
100	7.0	-	-

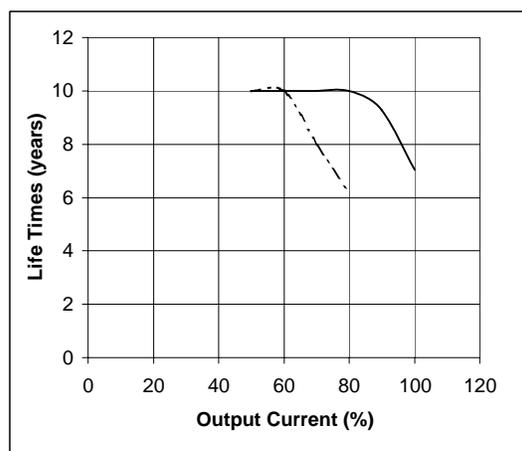

Note : E-cap life calculation is based on 8hrs/day operation.

4. Electrolytic capacitor lifetime

MODEL : LS25-5

Mounting D

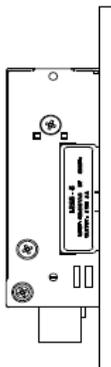

Ta = 40°C ———
 = 50°C - - - - -
 = 70°C

Vin = 115VAC

Load (%)	Life Time (years)		
	Ta = 40°C	Ta = 50°C	Ta = 70°C
50	10.0	10.0	3.3
60	10.0	10.0	2.5
70	10.0	7.6	-
80	10.0	5.5	-
90	8.1	4.1	-
100	5.7	2.8	-

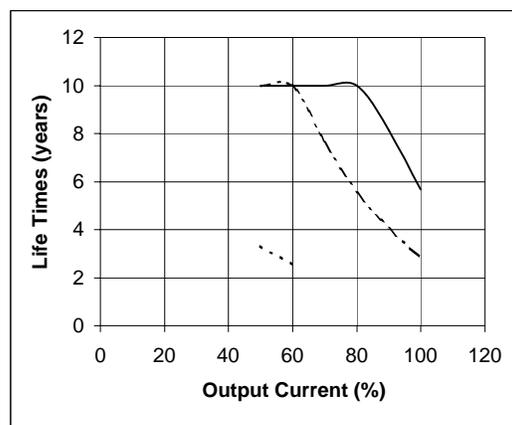

Vin = 230VAC

Load (%)	Life Time (years)		
	Ta = 40°C	Ta = 50°C	Ta = 70°C
50	10.0	10.0	4.1
60	10.0	10.0	3.0
70	10.0	9.4	-
80	10.0	7.1	-
90	10.0	5.6	-
100	8.5	4.2	-

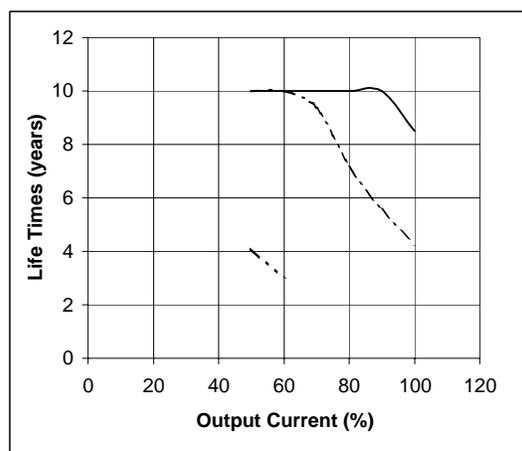

Note : E-cap life calculation is based on 8hrs/day operation.

6. Noise simulation test

MODEL : LS25-5

(1) Test circuit and equipment

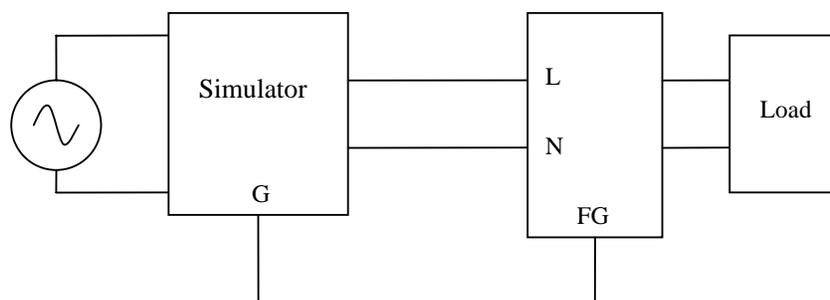

Simulator : INS-400L Noise Laboratory Co.,LTD

(2) Test conditions

- | | | | |
|-----------------------|----------------|------------------|-----------------|
| • Input voltage | : 115, 230VAC | • Noise level | : 0V~2.4kV |
| • Output voltage | : Rated | • Phase shift | : 0° ~ 360° |
| • Output current | : 0%, 100% | • Polarity | : +, - |
| • Ambient temperature | : 25°C | • Mode | : Normal Common |
| • Pulse Width | : 0ns ~ 1000ns | • Trigger select | : Line |

(3) Acceptable conditions

1. Not to be broken.
2. No output shutdown.
3. No other out of order.

(4) Test result O K

7. Abnormal test

MODEL : LS25-5

(1) Test Condition

Input Voltage : 230VAC Output Current : 100% Ta : 25°C, 70% RH

(2) Test Results

(Da: Damaged)

No.	Test Position		Test Mode		Test Results												NOTE	
	LOCATION	TEST POINT	S H O R T	O P E N	1	2	3	4	5	6	7	8	9	10	11	12		
					F I R E	S M O K E	B U R S T	S M E L H O T	R E D H O T	D A M A G E	F U S E B L O W	O C P	O V P	N O O U T P U T	N O C H A N G E	O T H E R		
1	D1	(AC) - (-)	•								•	•			•		D1 Spoilt	
2	D2		•													•	Vo out of regulation	
3	D3		•												•			
4	D4		•												•			
5	A1	1-4	•												•			
		2-4	•													•		
		3-4	•												•			
		5-4	•												•			
		7-4	•								•	•			•		D1 Spoilt	
		4		•												•		
		5		•												•		
6	C4	(+)Bulk - (-)Bulk	•								•	•			•		D1 Spoilt	
7	C6		•												•		Vo out of regulation	
8	C7		•												•			
9	C8		•												•			
10	C9		•												•		Hissing Sound	
			•												•			

7. Abnormal test

MODEL : LS25-5

(1) Test Condition

Input Voltage : 230VAC Output Current : 100% Ta : 25°C, 70% RH

(2) Test Results

(Da: Damaged)

No.	Test Position		Test Mode		Test Results												NOTE	
	LOCATION	TEST POINT	S H O R T	O P E N	1	2	3	4	5	6	7	8	9	10	11	12		
					F I R E	S M O K E	B U R S T	S M E L	R E D H O T	D A M A G E	F U S E B L O W	O C P	O V P	N O O U T P U T	N O C H A N G E	O T H E R		
11	C10		•	•											•			
12	C11		•	•												•		
13	C12		•	•								•						
14	C17		•	•													• Vo drop to 3.9V • Hissing Sound	
15	T1	4-5	•													•		
		1-2	•														•	
		6,7 - 9,10	•										•					Hiccup Mode
16	PC1	1-2	•									•		•	•		Hiccup Mode. Z1 spoilt	
		3-4	•													•		
		1-2		•								•		•	•			Hiccup Mode. Z1 spoilt
		3-4			•							•		•	•			Hiccup Mode. Z1 spoilt
17	A2	A - K	•									•		•			Hiccup Mode	
		R - K	•														• Vo drop to 3.6V	
		R - A	•									•		•	•			Hiccup Mode. Z1 spoilt
18	R3		•												•			
19	R7		•	•												•		
20	R8		•	•												•		
21	R10		•	•											•			
22	R11		•	•												•		
23	R12		•	•												•		
24	R13		•	•												•		
25	R18		•	•												•		
26	R20		•	•												•		
27	R22		•	•												•		
28	R21		•	•													• Hissing Sound	
28	R21															•	Hiccup Mode. Z1 spoilt	
																•	Hiccup Mode. Z1 spoilt	
29	R23															•	Hiccup Mode. Z1 spoilt	
																•	Hiccup Mode. Z1 spoilt	

8. Thermal shock test

MODEL : LS25

(1) Equipment used

THERMAL SHOCK CHAMBER TSA-101S-W (ESPEC CORP.)

(2) The number of D.U.T.(Device Under Test)

1 unit

(3) Test Conditions

- Ambient temperature : -45°C ↔ 90°C
- Test time : 30 mins each temp.
- Test cycle : 100 cycles
- Not operating

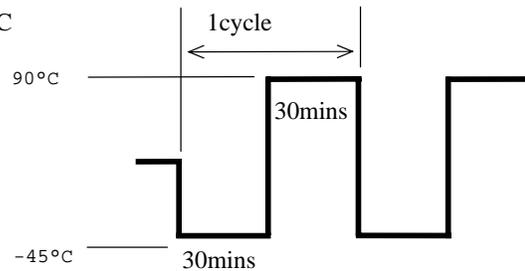

(4) Test Method

Before testing, check if there is no abnormal output, then put the D.U.T. in testing chamber, and test it according to the above cycle. 100 cycles later, leave it for 1 hour at the room temperature, then check if there is no abnormal output.

(5) Test Results OK

Vin : 230VAC Io : 100%			5V			
			From		To	
Ripple&Spike noise	Vin = 88V	mV	27		30	
Line regulation	Full load	mV	0		0	
Load regulation		mV	14		13	
Efficiency	Pin	W	31.167	80.2%	31.096	80.3%
	Vout	V	4.999		4.994	
	Iout	A	5		5	
Solder condition • etc.			—————		OK	