

INDEX

1. MTBF; Calculated Value of MTBF	R - 1
2. Component Derating	R - 2
3. Temperature Rise	R - 4
4. Elec. Capacitor Computed Life	R - 5
5. Abnormal Test	R - 6
6. Vibration Test	R - 7
7. Noise simulate test	R - 8
8. Electro-static Discharge Test	R - 9
9. Impulse test	R - 10

The above data are typical values. As all units have the same characteristics, the data to be considered as ability values.

NEMIC-LAMBDA

NNS50

M. T. B. F.

1. Method of calculation:

This calculation is by 'components count method' laid down by the DC Stabilized Power Supplies (Switching mode) committee of EIAJ.

The MTBF is determined by means of a fixed component failure rate λ_c given to each component and the number of component count of each type of component. λ_c is determined based on MIL-HDBK-217D.

Please refer to EIAJ handbook no. RCF-9021 for formula:

$$MTBF = \frac{1}{\lambda_{equip}} = \frac{1}{\sum_{i=1}^n N_i(\lambda_c)_i} \times 10^6 \text{ (Hrs)}$$

λ_{equip} = Total equipment failure rate (failures / 10^6 hrs)

λ_c = Failure rate of the i^{th} component

N_i = Number of i^{th} component

n = Number of categories of component

2. MTBF Value:

Conditions: Nominal line, rated load

Ambient Temperature 25 C °

MTBF=96920hrs

R-1

NNS-50

2. COMPONENT DERATING

MODEL : NNS50 - 5

(1) calculation method:

conditions:

Input: 100VAC Output 5V 10A (100%)

Ambient temperature : 50° C

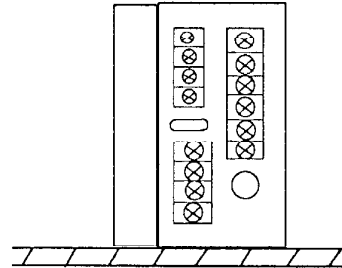

Mounting Method : Standard

(b) Semiconductor

Compared with maximum junction temperature and actual one which is calculated based on ambient temperature, power dissipation and thermal impedance.

(c) IC, Resistors, Capacitors, etc.

Ambient temperature, operating conditions, power dissipation and so on are within derating criteria.

(d) Calculating criteria:

$$\Theta_{j-c} = \frac{T_j(\max) - T_c}{P_c(\max)} \quad \Theta_{j-a} = \frac{T_j(\max) - T_a}{P_c(\max)}$$

T_c : Case Temperature at Start Point of derating ; 25° C in general

T_a : Ambient Temperature at Start Point of Derating ; 25° C in general

$P_c(\max)$: Maximum Power Dissipation

$T_j(\max)$: Maximum Junction Temperature

Θ_{j-c} : Thermal Impedance between Junction and Case

Θ_{j-a} : Thermal Impedance between Junction and Air

NNS50

(2) Component Derating List

Location No.	Parts Name	MAX Rating	Actual Rating	Derating Factor	Note
Q1,Q2, Q3,Q4	MOSFET	$T_{j_{max}} = 150^{\circ}\text{C}$	$T_j = 91.3^{\circ}\text{C}$	0.61	
Q6,Q7	MOSFET	$T_{j_{max}} = 175^{\circ}\text{C}$	$T_j = 102^{\circ}\text{C}$	0.58	
SR1	SCR	$T_{j_{max}} = 125^{\circ}\text{C}$	$T_j = 98.7^{\circ}\text{C}$	0.79	
D101	REC.DIODE	$T_{j_{max}} = 150^{\circ}\text{C}$	$T_j = 103^{\circ}\text{C}$	0.69	
D1	REC.BRIDGE	$T_{j_{max}} = 150^{\circ}\text{C}$	$T_j = 89.5^{\circ}\text{C}$	0.60	
DT1	LED	$I_{f_{max}} = 35\text{mA}$	$I_f = 15\text{ma}$	0.43	
A3,A4,A5	OP-AMP	$T_{j_{max}} = 150^{\circ}\text{C}$	$T_j = 81^{\circ}\text{C}$	0.54	
A1	LM317M	$T_{j_{max}} = 125^{\circ}\text{C}$	$T_j = 85^{\circ}\text{C}$	0.68	
A2	REFERENCE	$T_{j_{max}} = 150^{\circ}\text{C}$	$T_j = 84,5^{\circ}\text{C}$	0.56	

NNS50**3. ΔT TEMPERATURE RISE****MODEL: NNS50-5**

Location No.	Parts Name	$\Delta T^{\circ}C$ TEMP. RISE
Q1	MOSFET	36.3
Q6	MOSFET	43.0
D101	RECT.BRIDGE	42.1
SR1	SCR	43.0
C2	ELEC. CAP.	32.4
C6	ELEC. CAP	31.6
T1	TRANSFORMER	61.5

Conditions:

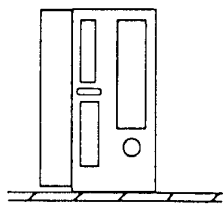
Mounting Method	 (STANDARD)
Input Voltage	100VAC
Output Volt.	5V
Output Curr.	10A (100%)

NEMIC-LAMBDA

ELEC. CAPACITOR COMPUTED LIFE

MODEL: NNS50-05

Computation Life curve

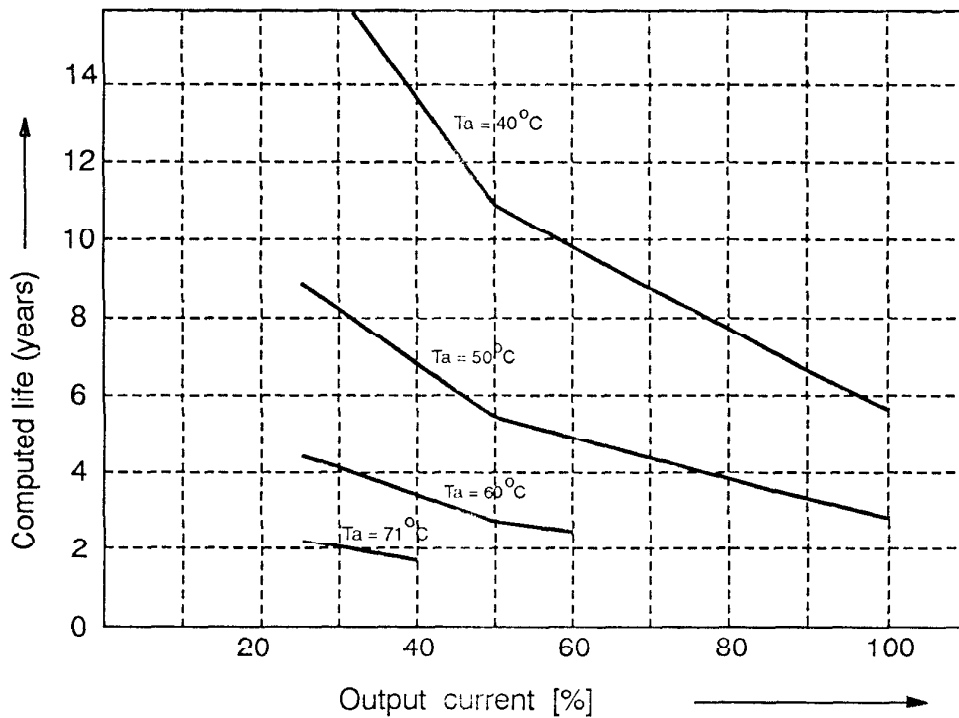

Formula: $L = L_0 \times 2^{\frac{105 - T_c}{10}}$ (year)

L: Elec. capacitor computed life
(24 hours per day, 365 days operation)

L₀: Guarantee life for Elec. Cap.

T_c: Case temperature of Elec. Cap.

CONDITIONS: Mounting method: Standard mounting

Input Voltage: 100 VAC

Output voltage: 5 VDC

Cooling: convection cooling

5. ABNORMAL TEST

(1) Conditions : Vin 115VAC, Vout 5VDC, Iout 10A(100%), Ta 25°C

(2) Test Results

No.	Test Point		Test Mode		Test Result												Note
	Location No.	Test Point	Short	Open	①	②	③	④	⑤	⑥	⑦	⑧	⑨	⑩	⑪	⑫	
					Fire	Smoke	Burst	Smell	Red Hot	Damaged	Fuse Blown	OVP	OCP	No Output	No Change	Others	
1	C2		•								•			•			F2
2				•												•	
3	D101		•								•			•			F2
4				•										•			
5	Q1d-s		•												•		F2
6				•											•		
7	Q6d-s		•								•			•			F2
8				•											•		
9	C5		•								•			•			F2
10				•											•		
11	C9		•										•	•			
12				•											•		
13	C14		•							•				•			R3 OPENED
14				•											•		
15	SR1 _{K-A}		•										•	•			
16				•											•		
17	Q5 _{C-E}		•											•			
18				•										•			
19	T1 _{SEC-1}		•								•			•			F2
20	T1 _{SEC-3}		•							•				•			TF1 OPENED

NNS50

6. VIBRATION TEST

MODEL: NNS50-5

(1) Vibration test class:

Frequency variable endurance test

(2) Equipment used:

Controller: GENRAD - 2503

Vibrator : ULHOLTZ - DICKIE TA1000

(3) Testing method:

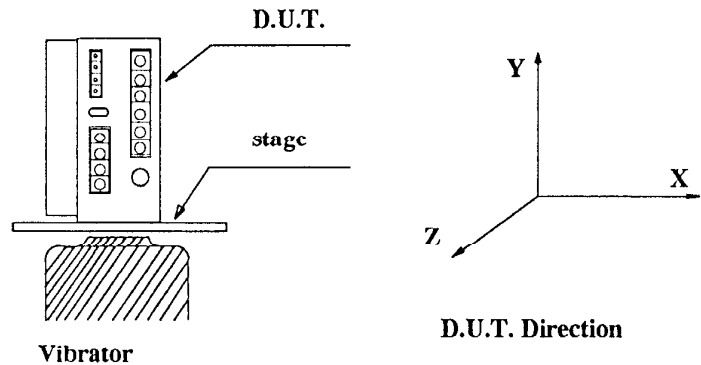

Sweep frequency : 10 ~ 55Hz

Sweep time: 1min

Acceleration: const. (2G)

Direction: X, Y, Z.

Test time: 1H each

Result:

OK NG

Check Item	Vout	Ripple (mV P-P)	D.U.T. stage	Note
Initial Direc.	5.020	1.5	OK	
X	5.020	1.5	OK	
Y	5.020	1.5	OK	
Z	5.020	1.5	OK	

NEMIC-LAMBDA

R-7

NOISE SIMULATE TEST

MODEL : NNS 50

(1) Test circuit and equipment

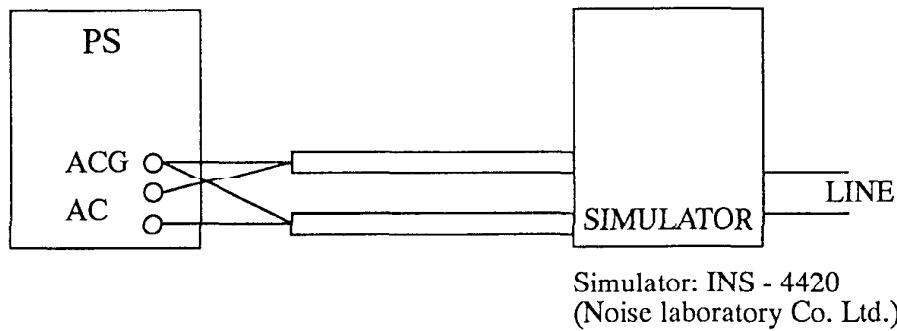

(2) Measuring Conditions

Input voltage	: Rated
Output voltage	: Rated
Output current	: 0%, 100%
Ambient temperature	: 25°C
Pulse width	: 50ns ~ 1000ns
Noise level	: 0 ~ 2KV
Phase shift	: 0 ~ 360 °C
Polarity	: +, -
MODE	: NORMAL, COMMON
TRIG SELECT	: LINE

(3) Acceptable conditions

1. Not to be broken
2. Output not to be shut down
3. No other out of orders

(4) Results

OK

NG

ELECTRO-STATIC DISCHARGE TEST

NNS50

(1) Equipment used:

- NSG-435 (SCHAFFNER)
- Discharge resistance : 330 Ohms Capacity :150pF

(2) Measuring Conditions:

- Input voltage : Rated (100 Vac)
- Output voltage : Rated
- Output current : Rated
- Ambient temperature : 25 °C
- Test voltage : +/- 3KV , +/- 5KV , +/- 10KV , +/- 15KV.

(3) Testing Method

Check if there is no abnormal output when the testing voltage is applied to operating D.U.T. (Device Under Test) on it's case, input terminal, output terminal , FG terminal and ACG terminal which are parts exposed to the human body. Testing cycle is at positive , negative polarity for three times each , and the applied voltage is to be gradually increased from 3KV to 15KV.

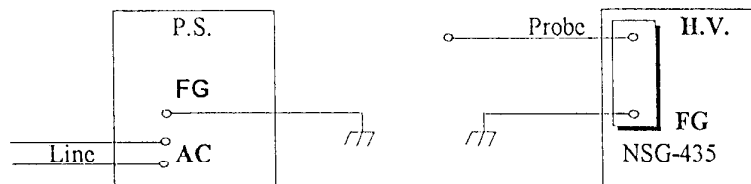

(4) Acceptable Conditions:

1. Not to be broken.
2. Output not to be shut down.
3. No other out of order conditions.

(5) Results: (OK) NG

IMPULSE TEST

NNS 50

MODEL : NNS 50

(1) Equipment used

LSS - 720 - T54 (Noise laboratory Co. Ltd.)

(2) Measuring Conditions

Input voltage	: Rated	Test voltage	: 5KV
Output voltage	: Rated	Test point	: Between FG - AC
Output current	: Full load	Test time	: 3 times
Ambient temperature	: 25 °C	Polarity	: + , -

(3) Testing method

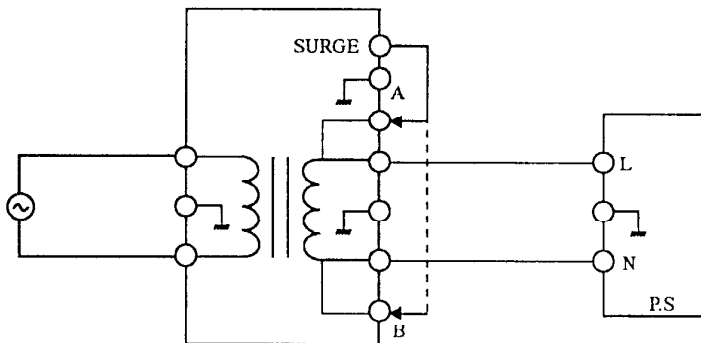
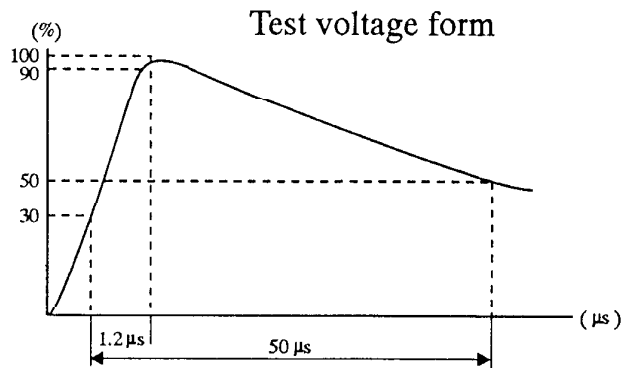

(4) Acceptable conditions

1. Not to be broken
2. Output not to be shut down
3. No other out of orders

(5) Results

OK

NG