



Test Report issued under the responsibility of:



**TEST REPORT
IEC 62368-1**

**Audio/video, information and communication technology equipment
Part 1: Safety requirements**

Report Number: E135494-A6006-CB-1

Date of issue.....: 2020-01-10

Total number of pages: 178

Applicant's name.....: **TDK-LAMBDA UK LTD**
Address: **KINGSLEY AVE**
ILFRACOMBE
EX34 8ES UNITED KINGDOM
UNITED KINGDOM

Name of Test Laboratory: UL International Polska Sp. z o.o.
preparing the Report: Aleja Krakowska 81, 05-090 Sekocin Nowy, Poland

Test specification:

Standard: IEC 62368-1:2014 (Second Edition)

Test procedure: CB Scheme

Non-standard test method.....: N/A

Test Report Form No.....: IEC62368_1B

Test Report Form(s) Originator: UL(US)

Master TRF.....: 2014-03

Copyright © 2014 Worldwide System for Conformity Testing and Certification of Electrotechnical Equipment and Components (IECEE), Geneva, Switzerland. All rights reserved.

This publication may be reproduced in whole or in part for non-commercial purposes as long as the IECEE is acknowledged as copyright owner and source of the material. IECEE takes no responsibility for and will not assume liability for damages resulting from the reader's interpretation of the reproduced material due to its placement and context.





If this Test Report Form is used by non-IECEE members, the IECEE/IEC logo and the reference to the CB Scheme procedure shall be removed.

This report is not valid as a CB Test Report unless signed by an approved CB Testing Laboratory and appended to a CB Test Certificate issued by an NCB in accordance with IECEE 02.

General disclaimer:

The test results presented in this report relate only to the object tested.
This report shall not be reproduced, except in full, without the written approval of the Issuing CB Testing Laboratory.
The authenticity of this Test Report and its contents can be verified by contacting the NCB, responsible for this Test Report.

Test Item description	: AC-DC Power Supply
Trade Mark	TDK LAMBDA TDK-Lambda
Manufacturer	TDK-LAMBDA UK LTD KINGSLEY AVE ILFRACOMBE EX34 8ES UNITED KINGDOM
Model/Type reference	Vega 450, Vega 650, Vega 900, Vega Lite 550 and Vega Lite 750 models (see enclosure MISC-Model Differences, 7-03, for details of models and nomenclature)
Ratings	<p>Vega 450 and Vega Lite 550. PSUs with cooling option F and without xEW and xFW options: Input voltage: 94.5-240 V ac nom., (abs. 85-264 V ac), 47-63 Hz, 8.5 A rms max. All other PSUs: Input voltage: 100-240 V ac nom., (abs. 90-264 V ac), 47-63 Hz, 8.5 A rms max.</p> <p>Vega 650, Vega Lite 750 and Vega 900. PSUs with cooling option F and without xEW and xFW options: Input voltage: 94.5-240 V ac nom., (abs. 85-264 V ac), 47-63 Hz, 12 A rms max. All other PSUs: Input voltage: 100-240 V ac nom., (abs. 90-264 V ac), 47-63 Hz, 11 A rms max.</p> <p>Input voltage for Vega 650 may also be rated 133-318V dc nom., (abs. 120-350V dc), 10A max., for models described within Products covered, custom models.</p> <p>(See enclosure MISC-Model Differences, 7-03, for details of ratings)</p>
Testing procedure and testing location:	
<input type="checkbox"/> CB Testing Laboratory:	
Testing location/ address	
Tested by (name + signature)	
Approved by (name + signature)	
Testing procedure: CTF Stage 1	
Testing location/ address	

Tested by (name + signature).....:			
Approved by (name + signature)			
<input type="checkbox"/>	Testing procedure: CTF Stage 2		
Testing location/ address.....:			
Tested by (name + signature).....:			
Witnessed by (name + signature).....:			
Approved by (name + signature)			
<input checked="" type="checkbox"/>	Testing procedure: CTF Stage 3		
<input type="checkbox"/>	Testing procedure: CTF Stage 4		
Testing location/ address.....:		TDK-LAMBDA UK LTD KINGSLEY AVE ILFRACOMBE EX34 8ES UNITED KINGDOM	
Tested by (name + signature).....:		Steve Hirstwood / Tester	
Witnessed by (name + signature).....:		Piotr A. Bizunowicz / Handler	
Approved by (name + signature)		Tracy Burgess / Authorized Signatory	
Supervised by (name + signature)		Piotr A. Bizunowicz / Handler	

List of Attachments (including a total number of pages in each attachment):

National Differences (25 pages)

Enclosures (219 pages)

Summary of testing:

Tests performed (name of test and test clause):

STEADY FORCE TEST, 250 N (4.4.4.2, ANNEX T.5)
 STEADY FORCE TEST, 30 N (4.4.4.2, ANNEX T.3)
 IMPACT TEST (4.4.4.4, ANNEX T.6)
 CLASSIFICATION OF ELECTRICAL ENERGY SOURCES (5.2, 5.7)
 DETERMINATION OF WORKING VOLTAGE (5.4.1.8)
 BALL PRESSURE TEST (5.4.1.10.3)
 SEPARABLE THIN SHEET MATERIAL (5.4.4.6.2)
 ELECTRIC STRENGTH TEST (5.4.9)
 SAFEGUARDS AGAINST CAPACITOR DISCHARGE AFTER DISCONNECTION OF A CONNECTOR (5.5.2.2)
 PROSPECTIVE TOUCH VOLTAGE AND TOUCH CURRENT MEASUREMENT (5.7)
 INPUT TEST: SINGLE PHASE (B.2.5)
 NORMAL OPERATING CONDITIONS TEMPERATURE MEASUREMENT (B.2.6)
 SIMULATED ABNORMAL OPERATING CONDITIONS (B.3)
 SIMULATED SINGLE FAULT CONDITIONS (B.4)
 TRANSFORMER OVERLOAD (ANNEX G.5.3.3)
 LIMITED SHORT CIRCUIT TEST (ANNEX R.1, 5.6.4.1, 5.6.4.4, 5.6.5.1)
 STEADY FORCE TEST, 10 N (ANNEX T.2, 5.4.2.6, 5.4.3.2, G.15.3.6)

Testing Location:

**CTF Stage 3: TDK-LAMBDA UK LTD
 KINGSLEY AVE
 ILFRACOMBE
 EX34 8ES UNITED KINGDOM**

Refer to enclosure 7-05

Summary of compliance with National Differences:**List of countries addressed:** Australia / New Zealand, EU Group and National Differences, USA / Canada

EU Group and National Differences applies to CENELEC member countries: Austria , Bulgaria, Belgium, Croatia, Cyprus, the Czech Republic, Denmark, Estonia, Finland, France, Germany, Greece, Hungary, Iceland, Ireland, Italy, Lithuania, Latvia, Luxembourg, Malta, the Netherlands, Republic of North Macedonia, Norway, Poland, Portugal, Romania, Slovakia, Slovenia, Spain, Serbia, Sweden, Switzerland, Turkey and the United Kingdom

 The product fulfils the requirements of: EN 62368-1:2014 + A11:2017

Copy of Marking Plate - Refer to Enclosure titled Marking Plate for copy.

TEST ITEM PARTICULARS:	
Classification of use by	Skilled person
Supply Connection	AC Mains DC Mains
Supply % Tolerance	+10%/-10%
Supply Connection – Type	To be determined in End Use Application
Considered current rating of protective device as part of building or equipment installation	20 A; building;
Equipment mobility	for building-in
Over voltage category (OVC)	OVC II
Class of equipment	Class I
Access location	To be determined in End Use Application
Pollution degree (PD)	PD 2
Manufacturer’s specified maximum operating ambient (°C)	50 (See also enc.7-04 for derating information)
IP protection class	IPX0
Power Systems	TN TT dc mains
Altitude during operation (m)	5000m excluding IEC60320 inlet and/or cooling option D or E (Papst fan 622HH) which have rating of 3000 m
Altitude of test laboratory (m)	2000 m or less
Mass of equipment (kg)	2.7
POSSIBLE TEST CASE VERDICTS:	
- test case does not apply to the test object..... :	N/A
- test object does meet the requirement :	P (Pass)
- test object does not meet the requirement :	F (Fail)
TESTING:	
Date of receipt of test item..... :	2018-10-04 to 2019-09-02
Date (s) of performance of tests..... :	2018-10-04 to 2019-08-30
GENERAL REMARKS:	
<p>"(See Enclosure #)" refers to additional information appended to the report. "(See appended table)" refers to a table appended to the report.</p> <p>Throughout this report a <input type="checkbox"/> comma / <input checked="" type="checkbox"/> point is used as the decimal separator.</p>	
Manufacturer’s Declaration per sub-clause 4.2.5 of IEC60068-2-1:	

The application for obtaining a CB Test Certificate includes more than one factory location and a declaration from the Manufacturer stating that the sample(s) submitted for evaluation is (are) representative of the products from each factory has been provided :	<input checked="" type="checkbox"/> Yes <input type="checkbox"/> Not applicable
---	--

When differences exist; they shall be identified in the General product information section.

Name and address of factory (ies) :	TDK-LAMBDA UK LTD KINGSLEY AVE ILFRACOMBE EX34 8ES UNITED KINGDOM PANYU TRIO MICROTRONICS CO LTD SHIJI INDUSTRIAL ESTATE DONGYONG NANSHA GUANGZHOU GUANGDONG 511453 CHINA
--	--

GENERAL PRODUCT INFORMATION:

Report Summary

All applicable tests according to the referenced standard(s) have been carried out.

Product Description

Product Description –
 Vega 450, Vega 650, Vega 900, Vega Lite 550 and Vega Lite 750 are switch mode power supply units for building into host equipment. There are essentially 2 converters (450 and 650) and all units use the same modules. The Vega 450 and 550 use the 450 converter whilst the Vega 650, 750 and 900 use the 650 converter.

The Vega series switch mode power supply consists of:

Main converter:

1. Input filter, consisting of the input fuse, X and Y capacitors, common mode chokes and series mode chokes up to the bridge.
2. PFC (boost circuit), consisting of the boost choke and associated switching FETs/circuitry.
3. Forward converter, consisting of the switching FETs/circuitry and of the main transformer supplying all modules.
4. Flyback transformer providing the auxiliary circuits and fan supply.

Outputs:

1. Standby circuit, consisting of the standby transformer and switching IC/circuitry supplying the standby outputs.
2. Secondary modules, all attaching to the main transformer. These may have various options.

Model Differences

Refer to enclosure 7-03

Additional application considerations – (Considerations used to test a component or sub-assembly) -

Refer to enclosure 7-04

Rating plates in Enclosure 13 are exemplary artwork. Due to modular nature of the products, it is impossible to include markings for all output ratings.

Technical Considerations

- The product was submitted and evaluated for use at the maximum ambient temperature (T_{ma}) permitted by the manufacturer's specification of : 50°C
- The product is intended for use on the following power systems : TN, TT, DC mains supply , (refer to model differences)
- Considered current rating of protective device as part of the building installation (A) : 20
- Mains supply tolerance (%) or absolute mains supply values : +10%/-10% for AC and DC input
- The equipment disconnect device is considered to be : Appliance inlet for models with inlet, to be considered in End Use Application for other models
- The following were investigated as part of the protective earthing/bonding : Printed wiring board trace (refer to Enclosure - Schematics + PWB for layouts)
- The following are available from the Applicant upon request : Intallation/service manual, also in languages other than English, including French language for Canadian national difference.
- The product was investigated to the following additional standard : EN 62368-1:2014 + A11:2017, AS/NZS 62368.1:2018
- When the IEC inlet option is fitted (option I) together with a plastic fan grill then the end face of the PSU with the fan grill may be Ordinary Person (operator) accessible.

Engineering Conditions of Acceptability

When installed in an end-product, consideration must be given to the following:

- The following product-line tests are conducted for this product : Earthing Continuity, Electric Strength
- The end-product Electric Strength Test is to be based upon a maximum working voltage of : AC mains supply Primary-Earthed Dead Metal: 298Vrms, 392Vpk , Primary-Secondary: 675Vpeak, 402Vrms., DC mains supply:- Primary to earth 560Vpk, 383Vrms. Primary to secondary, 588Vpeak, 393Vrms.
- The following output circuits are at ES1 energy levels : Refer to enclosure 7-03
- The following output circuits are at ES2 energy levels : Refer to enclosure 7-03
- The following output circuits are at ES3 energy levels : Refer to enclosure 7-03
- The following output circuits are at PS3 energy levels : All outputs
- The maximum investigated branch circuit rating is : 20 A
- The investigated Pollution Degree is : 2
- Proper bonding to the end-product main protective earthing termination is : Required
- An investigation of the protective bonding terminals has : been conducted
- The following input terminals/connectors must be connected to the end-product supply neutral : terminal "N"
- The following end-product enclosures are required : Mechanical, Electrical, Fire
- The following magnetic devices (e.g. transformers or inductor) are provided with an OBJ2 insulation system with the indicated rating greater than Class A (105°C) : T1 (155), T2 (155), TX3 (155), TX1 (155), main transformer (155)
- The following components require special consideration during end-product Thermal (Heating) tests due to the indicated maximum temperature measurements during component-level testing : For cooling option C: TX1 (155°C) , main transformer (155°C), see also enclosure 7-04 for any custom cooling configuration or use outside ratings.

- The following input terminals were evaluated as suitable for direct connection to the DC Mains Supply :
Input L,N - for models with DC rating
- The equipment is suitable for direct connection to : AC mains supply for models with IEC60320 appliance coupler
- The power supply was evaluated to be used at altitudes up to : 5000m, excluding the IEC60320 inlet and cooling options d and e which are rated up to 3000m
- The End Use fixings screw penetration require special attention: see handbook in enclosures for details

ENERGY SOURCE IDENTIFICATION AND CLASSIFICATION TABLE:	
(Note 1: Identify the following six (6) energy source forms based on the origin of the energy.) (Note 2: The identified classification e.g., ES2, TS1, should be with respect to its ability to cause pain or injury on the body or its ability to ignite a combustible material. Any energy source can be declared Class 3 as a worse case classification e.g. PS3, ES3.)	
Electrically-caused injury (Clause 5): (Note: Identify type of source, list sub-assembly or circuit designation and corresponding energy source classification) Example: +5 V dc input ES1	
Source of electrical energy	Corresponding classification (ES)
Primary circuits (Not accessible)	ES3
Input connector (Stored capacitance)	ES1
Module secondary circuits with up to 3 turn secondary's before output choke (Not accessible)	ES1
Module secondary circuits with 4 or 5 turn secondary's before output choke (Not accessible)	ES2
W8 module before output choke (Not accessible)	ES3
Standby secondary circuits	ES1
PSU output	ES1 or ES2 or ES3, see diagram (depending on model)
Electrically-caused fire (Clause 6): (Note: List sub-assembly or circuit designation and corresponding energy source classification) Example: Battery pack (maximum 85 watts): PS2	
Source of power or PIS	Corresponding classification (PS)
All circuits	PS3 (Declared)
Injury caused by hazardous substances (Clause 7) (Note: Specify hazardous chemicals, whether produces ozone or other chemical construction not addressed as part of the component evaluation.) Example: Liquid in filled component Glycol	
Source of hazardous substances	Corresponding chemical
N/A	N/A
Mechanically-caused injury (Clause 8) (Note: List moving part(s), fan, special installations, etc. & corresponding MS classification based on Table 35.) Example: Wall mount unit MS2	
Source of kinetic/mechanical energy	Corresponding classification (MS)
Sharp edges/corners	MS1
Fan blades	MS1
Product mass	MS1
Thermal burn injury (Clause 9) (Note: Identify the surface or support, and corresponding energy source classification based on type of part, location, operating temperature and contact time in Table 38.) Example: Hand-held scanner – thermoplastic enclosure TS1	
Source of thermal energy	Corresponding classification (TS)
Power supply (except option I, IEC inlet models)	TS3 (accessible to skilled person only).

ENERGY SOURCE IDENTIFICATION AND CLASSIFICATION TABLE:	
Power supply option I (IEC inlet models)	TS1
Radiation (Clause 10) (Note: List the types of radiation present in the product and the corresponding energy source classification.) Example: DVD – Class 1 Laser Product RS1	
Type of radiation	Corresponding classification (RS)
N/A	N/A

ENERGY SOURCE DIAGRAM

Indicate which energy sources are included in the energy source diagram. Insert diagram below

ES PS MS TS RS

Electrical Energy Source Classification

Module's with up to 3 turn secondaries and primary option

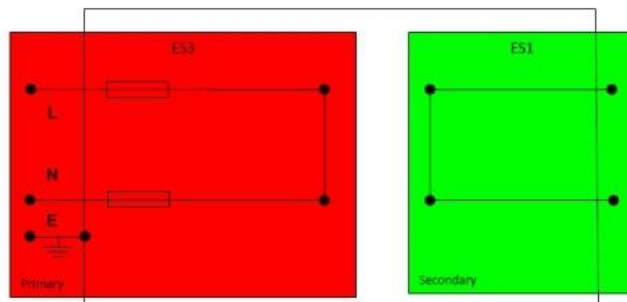

Module's with greater than 4 turn secondaries

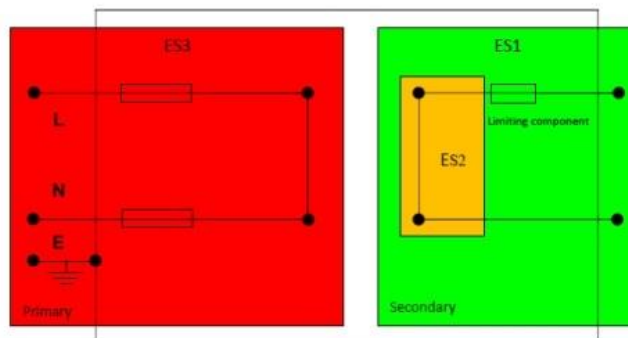

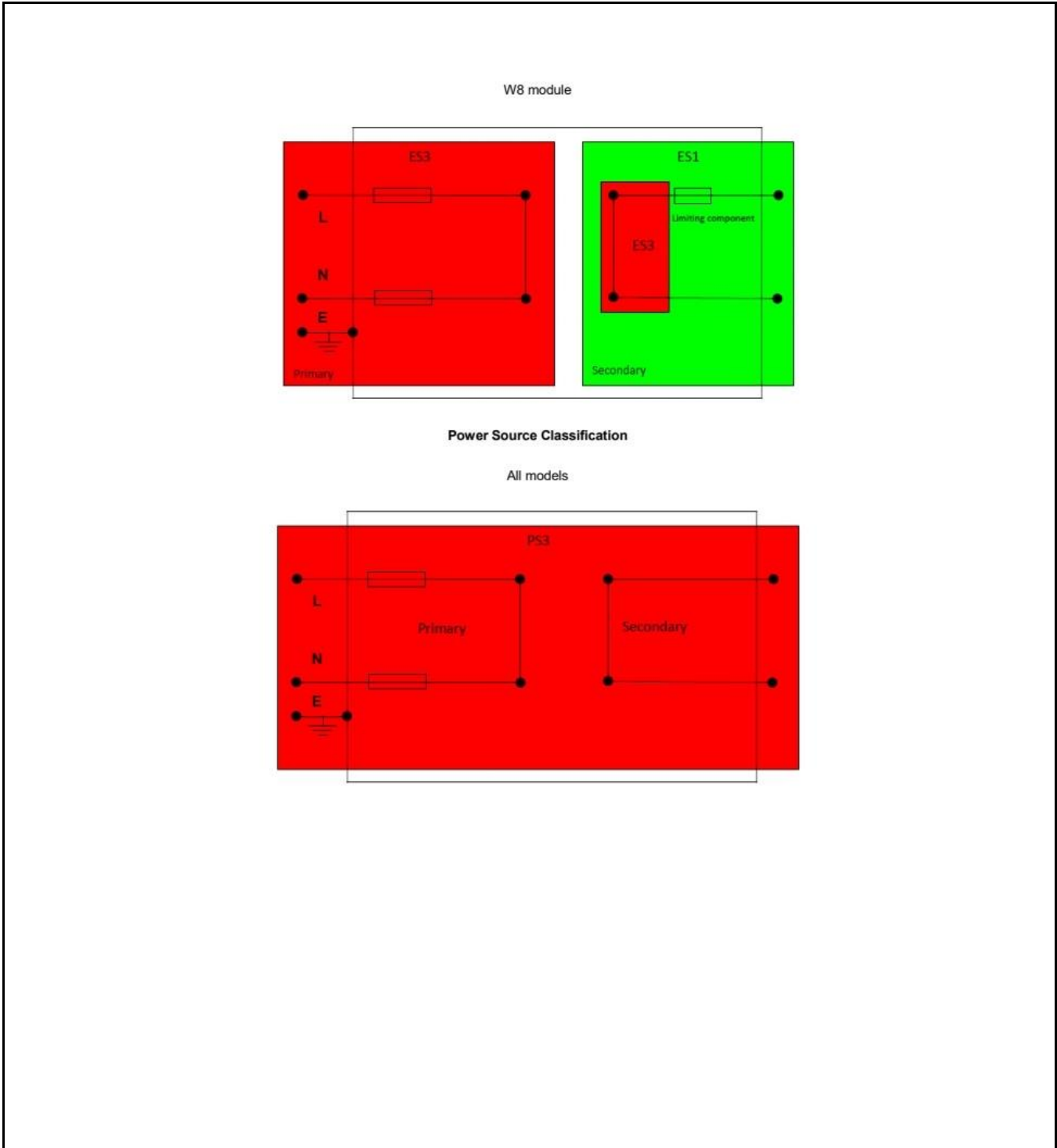

Mechanical Energy Source Classification

All models

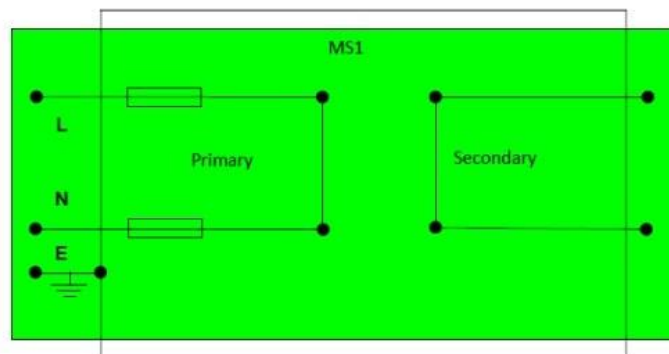

Thermal Energy Source Classification

All models except option I (IEC inlet model)

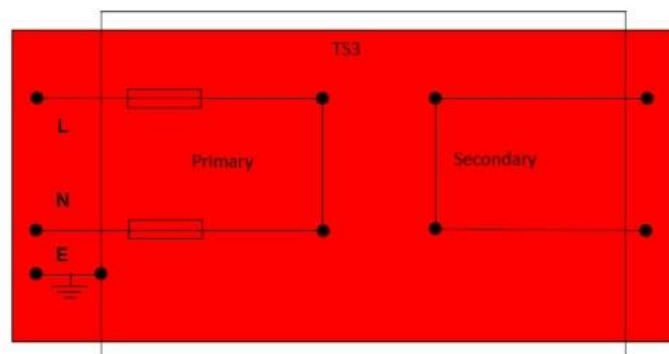

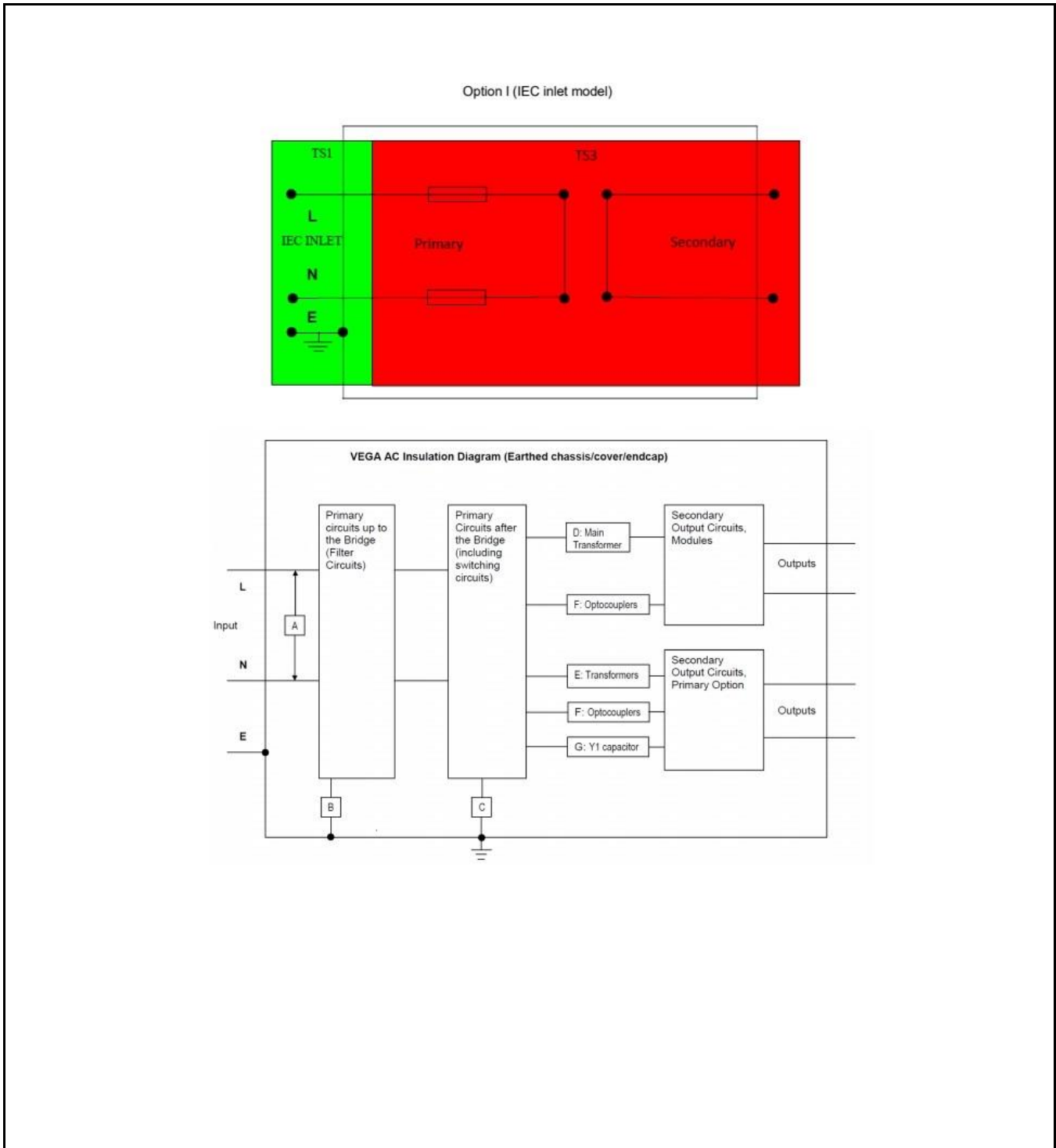

Enclosures

Miscellaneous ID 07-03

Page 1 of 13

Report No.

Model Differences

Vega 450, Vega 650, Vega 900, Vega Lite 550 and Vega Lite 750 series.

PRODUCTS COVERED

Vega models as described below:

Units may be marked with a Product Code: Ky*, KVy* or Vy* where y may be 4, 5, 6, 7 or 9 and * may be any series of numbers from 0 to 9 and/or any letters from A to Z.

a) V4, V5, V6, V7, V9, Vega 450, Vega 650, Vega 900, Vega Lite 550, Vega Lite 750, Vega Smart or Vega Smart Plus

where V4 = Vega 450 range
V5 = Vega Lite 550 range
V6 = Vega 650 range
V7 = Vega Lite 750 range
V9 = Vega 900 range

Vega Smart = Vega 450 or 650 PSU with primary digital option fitted

Vega Smart Plus = Vega 450 or 650 PSU with primary and secondary digital options fitted

(may be prefixed by NS - # / or - where # may be up to any four letters and may be followed by -\$ where \$ may be any number between 000 to 999, indicating non-safety related model differences.

b) followed by: A, C, D, E, F, R, Q or P

where F = Standard fan, forward airflow
R = Standard fan, reverse air
Q = Quiet fan, forward airflow
P = Quiet fan, reverse air
C = Customer air
A = Custom models only
D* = Ruggedised fan, forward airflow
E* = Ruggedised fan, reverse air

* These fans must not be used for user accessible applications.

c) optionally followed by: F, I or S

where F = Fast-on or quick connect input terminals
S = Screw input terminals
I = IEC input

d) followed by: S, M, G, L, R, or T

where S = Standard Leakage (Class B Filter)
M = Medium Leakage
G = Moderate Leakage
L = Low Leakage
R = Reduced Leakage
T = Tiny Leakage

e) optionally followed by: E, F, EV, FV, EY, FY, xEW, xFW or D

Enclosures

Miscellaneous ID 07-03

where E = AC fail with PSU & fan enable and 5V aux supply
 F = AC fail with PSU & fan inhibit and 5V aux supply
 EV = AC fail with PSU & fan enable and 5V/300mA aux supply
 FV = AC fail with PSU & fan inhibit and 5V/300mA aux supply
 EY = AC fail with PSU & fan enable, 5V/300mA aux supply and fan fail signal
 FY = AC fail with PSU & fan inhibit, 5V/300mA aux supply and fan fail signal
 xEW = AC fail with PSU & fan enable and 5-15V/1A aux supply, where x = voltage setting
 xFW = AC fail with PSU & fan inhibit and 5-15V/1A aux supply, where x = voltage setting
 D = Primary digital option. Provides PSU inhibit and enable, fan monitor, standby supply, hours of operation, serial numbers, mains fail, over temperature warning. When secondary digital options fitted also provides status bytes, unit and module IDs, grouping, digital voltage and current limit programming, secondary inhibit and enable, secondary turn on delay, global and secondary module good, module monitoring.

Modules

B@, C@, C1Y, D@, E@, F1, F2, H@/@ or @_@, L@, W2, W5, W8 & W9.

where the letter represents a module and @ is a number between 1 and 5, which represents the number of turns on the transformer secondary. By reference to the following table, this in turn defines the permitted voltage range of the module.

@ may optionally be followed by the letter L or H, where L and H indicate the low or high output voltage variants of the module.

For W2, W5, W8 & W9 modules only: @ is followed by F, T, E or S
 where F = Fixed OVP
 T = Tracking OVP
 E = Fixed OVP, high current output
 S = Tracking OVP, high current output

Followed by F or S, where F indicates fast-on output terminals and S indicates screw output terminals.

or Z#

where # is a number between 1 and 99. This code represents any two of the above modules that have had their outputs paralleled together. The number # is a module reference number and does not represent the number of turns. May optionally be followed by F or S, where F indicates fast-on output terminals and S indicates screw output terminals.

or BB@, CC@, DD@, EE@, HH@/@ or @_@, JJ@/@ or @_@, LL@, C5B4 or B5B4

where @ is a number between 1 and 5, which represents the number of turns on the transformer secondary. For HH@/@ or @_@ the code represents one H module that has its two outputs connected in series. For all other variants this code represents two modules, selected from those listed above, which have their outputs connected in series. May optionally be followed by F or S, where F indicates fast-on output terminals and S indicates screw output terminals.

Note: Series outputs may make all outputs hazardous, see "ES ratings and Outputs Connected In Series" below for details. JJ@/@ or @_@ modules are HH@/@ or @_@ modules with reduced OVP and/or current ratings.

or X1, X2, X4, X8, XR1, XR2, XR4 & XR8

where the number relates to the maximum voltage capability of the X or XR module (voltage rating is

Enclosures

Miscellaneous ID 07-03

10 multiplied by the number). The X or XR modules are connected to the output terminals of B, D, E or W modules, which may be connected in series or parallel. The X and XR modules contains diodes in series with their output (for paralleling use). The X module also has additional circuitry for remote sense, paralleling with other X modules and module inhibit. A maximum of two X or XR modules may be fitted in a PSU.

or B/S, where B/S indicates that a blanking plate is fitted in place of a module.

Any of the above modules (except the X and XR modules) may have the module letter preceded with # or ## where # is represents the module output voltage.

Module Options:

N, E, P, R, T, L, K, D, V \ddagger or R \ddagger

where N = Inhibit, module good and remote sense.
 E = Enable, module good and remote sense
 P = Parallel with current share
 R = Remote sense (twin output modules only)
 T = Remote sense (one output of twin output modules only)
 L = Module good using LED indication
 K = Allows for Vega products to be paralleled with Omega products

D = Secondary digital option (may only be fitted to single output modules). Provides analogue voltage and resistive programming, current limit modes, inhibit output, enable output, turn on delay, module good, N+1 paralleling.

V \ddagger = Voltage programmable output voltage
 R \ddagger = Resistance programmable output voltage

where \ddagger represents a number between 1 and 99. Each number indicates an option variant which does not affect safety, of these the following are standard variants:
 1 = Inhibit, fixed current limit
 2 = Inhibit, programmable current limit
 3 = Enable, fixed current limit
 4 = Enable, programmable current limit

May additionally be marked with K4x, K5x, K6x or V4x,V5x,V6x,V7x,V9x where x can be up to five digits of any letter or number between 0 and 9 indicating non-safety related model differences.

ELECTRICAL & THERMAL RATINGS:

Output modules:

Module	O/P V	Rated I (A)	P (W)	Slots	Turns	A/T
B1L	1 - 3.8V	20A	76W	1	1	20
B1H	2 - 5.5V	20A	110W	1	1	20
B2	3 - 9V	25A	225W	1	2	50
B3	9.1 - 16.2V	12A	195W	1	3	36
B4	16.3 - 21.5V	10A	215W	1	4	40
B5	21.6 - 31V	6A	186W	1	5	30
C1	1 - 4.1V	35A	144W	1	1	35
C1Y	1 - 4.1V	40A	164W	1	1	40
C3	9.1 - 16.2V	18A	292W	1	3	54
C4	16.3 - 21.5V	14A	301W	1	4	56
C5	21.6 - 31V	10A	310W	1	5	50
D1L	1 - 3.8	50A	190W	1.5	1	50

Enclosures

Miscellaneous ID 07-03

D1H	3.9 - 5.5	50A	275W	1.5	1	50
D2	3.8 - 9V	45A	405W	1.5	2	90
D3	8 - 16.5V	24A	396W	1.5	3	72
D4	14 - 21.5V	18A	387W	1.5	4	72
D5	21 - 28V	15A	420W	1.5	5	75
E1	1 - 3.8V	60A	228W	2	1	60
E2	3.8 - 8V	60A	480W	2	2	120
E3L	8 - 13.9V	40A	556W	2	3	120
E3H	14 - 15V	36A	540W	2	3	108
E4	14 - 19.9V	30A	597W	2	4	120
E5L	20 - 24V	27A	648W	2	5	135
E5H	24 - 28V	25A	650W	2	5	125
F1	1 - 3.8V	80A	640W	2	1	80
F2	3.8 - 8V	80A	640W	2	2	160
H1L/1L	1-3.8/1-3.8V	12A/8A	46W/31W	1	1/1	12/8
H1L/1H	1-3.8/3.9-5.5V	12A/8A	46W/44W	1	1/1	12/8
H1H/1L	3.9-5.5 /1-3.8V	12A/8A	66W/31W	1	1/1	12/8
H1H/1H	3.9-5.5 /3.9-5.5V	12A/8A	66W/44W	1	1/1	12/8
H1L/2	1-3.8/5-9V	12A/6A	46W/54W	1	1/2	12/12
H1H/2	3.9-5.5/5-9V	12A/6A	66W/54W	1	1/2	12/12
H1L/3	1-3.8/9.1-16.2V	12A/6A	46W/98W	1	1/3	12/18
H1H/3	3.9-5.5/9.1-16.2V	12A/6A	66W/98W	1	1/3	12/18
H1L/4	1-3.8/16.3-25V	12A/4.5A	46W/113W	1	1/4	12/18
H1H/4	3.9-5.5/16.3-25V	12A/4.5A	66W/113W	1	1/4	12/18
H2/1L	5.6-9/1-3.8V	10A/8A	90W/31W	1	2/1	20/8
H2/1H	5.6-9/3.9-5.5V	10A/8A	90W/44W	1	2/1	20/8
H2/2	5.6-9/5.6-9V	10A/6A	90W/54W	1	2/2	20/12
H2/3	5.6-9/9.1-16.2V	10A/6A	90W/98W	1	2/3	20/18
H2/4	5.6-9/16.3-25V	10A/4.5A	90W/113W	1	2/4	20/18
H3/1L	9.1-16.2/1-3.8V	10A/8A	162W/31W	1	3/1	30/8
H3/1H	9.1-16.2/3.9-5.5V	10A/8A	162W/44W	1	3/1	30/8
H3/2	9.1-16.2/5.6-9V	10A/6A	162W/54W	1	3/2	30/12
H3/3	9.1-16.2/9.1-16.2V	10A/6A	162W/98W	1	3/3	30/18
H3/4	9.1-16.2/16.3-25V	10A/4.5A	162W/113W	1	3/4	30/18
H5/1L	16.2-31/1-3.8V	5A/8A	155W/31W	1	5/1	25/8
H5/1H	16.2-31/3.9-5.5V	5A/8A	155W/44W	1	5/1	25/8
H5/2	16.2-31/5.6-9V	5A/6A	155W/54W	1	5/2	25/12
H5/3	16.2-31/9.1-16.2V	5A/6A	155W/98W	1	5/3	25/18
H5/4	16.2-31/16.3-25V	5A/4.5A	155W/113W	1	5/4	25/18
L1	4.2 - 5.5V	35A	193W	1	1	35
W2	0.25 - 7.5V	30A	225W	1	2	60
W5 (standard)	0.25 - 32V	8.5A	272W	1	5	42.5
W5 (high current o/p)	0.25 - 15V	10A	272W	1	5	50
	15.01 - 32V	8.5A				
W8	1 - 48V	5A	240W	1	8	40
W9	1-30V	2A	60W	1	5	10
X1	10V (see Note 1)	90A	See Note 2	1	-	-
X2	20V (see Note 1)	64.5A	See Note 2	1	-	-
X4	40V (see Note 1)	32.4A	See Note 2	1	-	-
X8	80V (see Note 1)	16.2A	See Note 2	1	-	-

Note 1: Actual voltage and current output of X and XR modules is dependent, and limited by, the ratings of the modules from which it is fed. The ratings given above are additional rating limitations imposed by the X module itself.

Note 2: The maximum power output of PSUs fitted with X or XR modules is reduced from its normal rated value

Enclosures

Miscellaneous ID 07-03

by the following power: $0.55 \times (\text{total X1 \& XR1 current}) + 0.7 \times (\text{total X2, X4, XR2 \& XR4 current}) + 0.9 \times (\text{total X8 \& XR8 current})$

Additional module limitations:

E2 module fitted in slots 4/5 is limited to 55A.

C1Y module can only be fitted in slot 1.

F2 module may only be fitted in slots 1/2 and is limited to 75A for ambient temperatures of greater than 45°C.

F1 module may only be fitted in slots 1/2.

For PSUs with three D modules fitted:

D1L & D1H in slots 2/3 is limited to 42A and in slots 4/5 is limited to 47A

D2 in slots 2/3 is limited to 40A

For 900W PSUs:

W2 module not permitted.

F1 and F2 modules not permitted.

PSUs fitted with a W2 module are limited to a maximum ambient of 45°C.

All the above ratings and limitations apply to the individual modules from which a series or paralleled pair is made.

ES ratings and Outputs Connected In Series:

Non-earthed outputs that have secondary's with 4 or more turns are ES2 as a single fault in the secondary may make them exceed the ES1 limits between output and earth.

Non-earthed outputs that are in series are ES1 if all the series outputs use 1 turn secondary's and there are no more than 3 outputs connected in series.

For series outputs, all outputs are ES1 except under the following circumstance: Outputs connected in series are ES2 if the highest rated module output at nominal voltage + 30% + the total voltage of the remaining series modules at the max rated voltage of each module $> 60\text{Vdc} < 120\text{Vdc}$ and ES3 for any greater output voltage.

The total voltage of series outputs must not exceed 160V.

The highest ES rating of any series outputs then applies to all the outputs.

Note:

All outputs have functional insulation to earth, and due consideration must be given to this in the end product design.

When the IEC inlet option is fitted (option I) together with a plastic fan grill then the end face of the PSU with the fan grill may be operator accessible.

Ratings Specific to Vega 450 and Vega Lite 550 Ranges:

PSUs with cooling option F and without xEW and xFW options:

Input voltage: 94.5-240 V ac nom., 85-264V ac max., 47-63 Hz, 8.5 A rms max.

All other PSUs:

Input voltage: 100-240 V ac nom., 90-264V ac max., 47-63 Hz, 8.5 A rms max.

Permitted orientations: Horizontal with chassis lowest, on either side or vertical with the airflow upwards.

Enclosures

Miscellaneous ID 07-03

Cooling Option	Max. Amb(°C)	Dual Width Modules Fitted	Max P(W)	Max AT (total)	Max Module AT in adj	I Rating regions (note 1)
F	See table below	No	See table below	180	n/a	100%
D	50	No	450	180	n/a	100%
		Yes	450	180	180	100%
R, E	50	No	450	180	n/a	100%
		Yes	450	180	162	90%
Q	50	No	450	180	n/a	100%
		Yes	450	180	180	100%
P	50	No	450	180	n/a	100%
		Yes	450	180	180	85%
C	50	See Customer Air Cooling section for ratings				

Note 1: The PSU main transformer has three regions for module secondary's separated by two primary windings. Starting nearest slot 1, region A, primary winding, region B, primary winding, region C. The total ampere turns (AT) in any two adjacent regions are limited to that in the table above column, "Max AT in adjacent regions (note 1)". See Mains transformer regions table page 16 for modules allowed in each region. The table uses module widths with a twin output module being single width. For PSUs fitted with F2 modules "Max AT in adjacent regions" does not apply.

n/a = not applicable

Ampere Turns (AT) is the sum of (output amps x secondary turns)

Power ratings for cooling option F:

I/P V (Vrms)	O/P P (W) Max. Amb 40°C	Max. Amb 50°C	
		xEW or xFW option fitted	xEW and xFW options not fitted
85	425	not permitted	425
90	470	450	450
100	520	450	500
110-149.9	570	450	550
150-264	630	450	560

Linear interpolation may be used to determine the permitted output power for input voltages between 85 and 110V.

Ratings Specific to Vega 650 and Vega 750 Lite Ranges:

PSUs with cooling option F and without xEW and xFW options:
 Input voltage: 94.5-240 V ac nom., 85-264V ac max., 47-63 Hz, 12 A rms max.

All other PSUs:
 Input voltage: 100-240 V ac nom., 90-264V ac max., 47-63 Hz, 11 A rms max.

Permitted orientations: Horizontal with chassis lowest, on either side or vertical with the airflow upwards.

Cooling Option	Max. Amb(°C)	Dual Width Modules	Max P(W)	Max AT (total)	Max Module AT in adj	I Rating
----------------	--------------	--------------------	----------	----------------	----------------------	----------

Enclosures

Miscellaneous ID 07-03

F	See table below	No Yes	See table below	220 220	n/a 180	100% 100%
D	50	No Yes	650 650	220 220	n/a 180	100% 100%
R, E	40	No Yes	530 550	212 212	n/a 158	100% 90%
	45	Yes	500	212	158	90%
	50	No Yes	575 600	180 210	n/a 162	100% 90%
		No	500	200	n/a	100%
Q	50	Yes No Yes	550 650 610	180 220 220	140 n/a 180	100% 100% 95%
		Yes	650	145	115	95%
P	40	Yes	500	203	152	85%
	45	Yes	420	203	152	85%
	50	No Yes	500 450	180 190	n/a 162	100% 85%
C	50	See Customer Air Cooling section for ratings				

Note 1: The PSU main transformer has three regions for module secondary's separated by two primary windings. Starting nearest slot 1, region A, primary winding, region B, primary winding, region C. The total ampere turns (AT) in any two adjacent regions is limited to that in the table above column, "Max AT in adjacent regions (note 1)". See Mains transformer regions table page 16 for modules allowed in each region. The table uses module widths with a twin output module being single width. For PSUs fitted with F2 modules "Max AT in adjacent regions" does not apply.

n/a = not applicable

Ampere Turns (AT) is the sum of (output amps x secondary turns)

Power ratings for cooling option F:

I/P V (Vrms)	O/P P (W)		
	Max. Amb 40°C	Max. Amb 50°C	
		xEW or xFW option fitted	xEW and xFW options not fitted
85	650	not permitted	615
90	720	650	650
100	830	650	720
110-149.9	900	650	770
150-264	900	900	900

Linear interpolation may be used to determine the permitted output power for input voltages between 85 and 110V.

Ratings Specific to Vega 900 Range:

PSUs with cooling option F and without xEW and xFW options:
Input voltage: 94.5-240 V ac nom., 85-264V ac max., 47-63 Hz, 12 A rms max.

All other PSUs:

Enclosures

Miscellaneous ID 07-03

Input voltage: 100-240 V ac nom., 90-264V ac max., 47-63 Hz, 11 A rms max.

Permitted orientations: Horizontal with chassis lowest, on either side or vertical with the airflow upwards.

For input voltages equal to or greater than 150V ac ratings are as follows:

Cooling Option	Max. Amb(°C)	Dual Width Modules	Max P(W)	Max AT (total)	Max Module AT in adj	I Rating
F, D	50	No	900	220	180	100%
		Yes	900	220	180	100%
Q	50	No	650	220	n/a	100%
		Yes	750	180	n/a	100%
C	50	See Customer Air Cooling section for ratings				

For input voltages less than 150V ac ratings are as follows:

Cooling Option	Max. Amb(°C)	Dual Width Modules	Max P(W)	Max AT (total)	Max Module AT in adj	I Rating	
F	See table below	No	See table below	220	n/a	100%	
		Yes	See table below	220	180	100%	
D	50	No	650	220	n/a	100%	
		Yes	650	220	180	100%	
R, E	40	No	530	212	n/a	100%	
		Yes	550	212	158	90%	
	45	Yes	500	212	158	90%	
		50	No	575	180	n/a	100%
	50		Yes	600	210	162	90%
		50	No	500	200	n/a	100%
Q	50		Yes	550	180	140	100%
		No	650	220	n/a	100%	
		Yes	610	220	180	95%	
P	40	Yes	650	145	115	95%	
		45	Yes	500	203	152	85%
			Yes	420	203	152	85%
50	No	500	180	n/a	100%		
	Yes	450	190	162	85%		
C	50	See Customer Air Cooling section for ratings					

Power ratings for cooling option F:

I/P Vrms	O/P P (W)		
	Max. Amb 40°C	Max. Amb 50°C	
		xEW or xFW option fitted	xEW and xFW options not fitted
85	650	not permitted	615
90	720	650	650
100	830	650	720
110-149.9	900	650	770

Enclosures

Miscellaneous ID 07-03

Linear interpolation may be used to determine the permitted output power for input voltages between 85 and 110V.

Note 1: The PSU main transformer has three regions for module secondary's separated by two primary windings. Starting nearest slot 1, region A, primary winding, region B, primary winding, region C. The total ampere turns (AT) in any two adjacent regions is limited to that in the table above column, "Max AT in adjacent regions (note 1)". See Mains transformer regions table page 16 for modules allowed in each region. The table uses module widths with a twin output module being single width. For PSUs fitted with F2 modules "Max AT in adjacent regions" does not apply.

n/a = not applicable

Ampere Turns (AT) is the sum of (output amps x secondary turns)

Main transformer regions table:

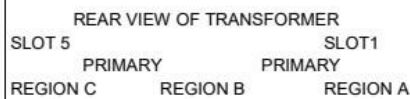

Slot 1	Slot 5.5	Slot 5.5
Region A	Region B	Region C
S	D	D
Blank	D	D
S	D, S	S
S	D	S
S	D	-
-	D	-
S	S, S, S	S
S	S, S	S
S	S	-
-	S	-
1.5	D	1.5
S	D	1.5
-	D	1.5
S	1.5, S	S
S	1.5	S
S	1.5	-
1.5	1.5	1.5
S	1.5, 1.5	S
S	1.5	1.5
-	1.5	1.5
-	1.5	-
-	S, S	D
-	1.5, S	S
1.5	1.5, S	S
-	D, S	S

Slot 1	Slot 5.5	Slot 5.5
Region A	Region B	Region C
1.5	1.5	-
S	S, S	D
1.5	1.5	D
-	F,M,S	S, S
-	F,M,S	S
-	F,M,S	-
-	F,M	-
-	F,M,S	D
-	F,M	D
-	F,M,S	1.5
-	F,M	1.5
-	F,M 1.5	1.5
-	F,M 1.5	S
Combined Modules		
S	D	D
-	D	D
1.5	D	1.5
S	D	1.5
-	D	1.5
S	1.5, 1.5	S
S	1.5, 1.5	-
-	1.5, 1.5	-
1.5	1.5, D	-
1.5	1.5	1.5

Enclosures

Miscellaneous ID 07-03

1.5	D	S	1.5	1.5, S	S
-----	---	---	-----	--------	---

D = Dual. S = Single, M = Module

Custom Models:

All ratings as per standard models unless otherwise stated.

Model: V6 RSF 3/1HS C3S B/S E2S
 Maximum outputs: 12V, 2A; 5V, 1.5A; 12V, 10A; 5V 52A
 Maximum Power: 411.5W
 Maximum ambient: 40°C
 Orientation: Horizontal only
 Cooling: Reverse air, Papst 612NM.

Model: V6 FISFV 5.1F2SP 12B3F 3.4E1SP
 Maximum outputs: 5.1V, 80A; 12V, 3A; 3.4V, 60A
 Maximum power: 648W
 Maximum ambient: 50°C
 Orientation: Horizontal only
 Cooling: Forward air

Model: V6FSS 24C5S 24D5S
 Maximum outputs: 24V, 10A; 24V, 15A
 Maximum Power: 600W
 Maximum ambient: 65°C
 Orientation: All except upside down and vertical with the airflow downwards
 Cooling: Forward air

Model: Vega 450 AFT B/S 24D5S 21D5S (K40054, NS-CLE-010)
 Input: 85-264Vac, 47-63Hz
 Maximum outputs: 24V, 12.5A; 21V, 7.143A
 Orientation: All except upside down and vertical with the airflow downwards
 Cooling: Papst 612NML or 612NGML or 612NMLE fan fitted with up to 66 ohms total resistance in series.
 Comments: Forward air.

Model: Vega 650 BFTF B/S 24.5E5HFN
 Input: 90-264Vac, 47-63Hz
 Maximum output: 24.5V, 18.37A
 Maximum output power: 450W
 Orientation: All except upside down and vertical with the airflow downwards
 Cooling: Papst 612NML or 612NGML fan fitted with up to 64 ohms total resistance in series.
 Comments: Reverse air.

Model: Vega 450 AFT B/S 24E5HS (NS-CLE-011)
 Input: 85-264Vac, 47-63Hz
 Maximum outputs: 24V, 14.59A
 Maximum output power: 350W
 Orientation: All except upside down and vertical with the airflow downwards
 Cooling: Papst 612NML or 612NGML fan fitted with up to 64 ohms total resistance in series.
 Comments: Forward air.

Model: NS-WKR/V4AFS 5/5H1H/1HFN 12/12H3/3F 5/5H1H/1HFN 25/25H5/4F (K40072)
 Input: 90-264Vac, 47-63Hz

Enclosures

Miscellaneous ID 07-03

<p>Maximum outputs: 5.5V, 2.5A; 5.5V, 2.5A; 12.5V, 2.5A; 12.5V, 2.5A; 5.5V, 2.5A; 5.5V, 2.5A; 26V, 1.5A; 26V, 1.5A Maximum output power: 195.5W Orientation: All except upside down and vertical with the airflow downwards Cooling: Papst 612NML or 612NMLE fan. Comments: Forward air.</p> <p>Model: NS-THE/V9FSSF B/S 28E5HS (K90036) Input: 90-264Vac, 47-63Hz Maximum outputs: 28V, 25A Maximum output power: 700W Orientation: All except upside down and vertical with the airflow downwards Cooling: Standard fan, forward airflow</p> <p>Model: Vega 450 ASS5FW 12.1C3S 3.33C1S 5.05B1HS 5.25/12.1H1H/3SR (K40089) Input: 90-264Vac, 47-63Hz Outputs: 12.1V, 9.5A; 3.3V, 9A; 5.05V, 20A; 12.1V, 2A; 5.25V, 4.7A (294.53W) Orientation: All except upside down and vertical with the airflow downwards Cooling: Papst 612NMLE fan, reverse air</p> <p>Model: Vega 650 ASS5FW 3.35C1Y5S 12.6/5.1H3/1HSR 6.1/12.6H2/3SR 5.1/5.3H1H/1HSR (K60162) Input: 90-264Vac, 47-63Hz Maximum outputs: 3.35V, 22A; 5.1V, 3.5A; 12.6V, 7A; 12.6V, 1A; 6.1V, 3A; 5.3V, 3A; 5.1V, 6.5A (259.7W) Orientation: All except upside down and vertical with the airflow downwards Cooling: Papst 612NMLE fan, reverse air</p> <p>Model: NS-MEL/V4FSS B/S 12/12H3/3S 6.7B2S 3.3C1SN (K40110) Input: 90-264Vac, 47-63Hz Maximum output: 12V, 10A; 12V, 6A; 6.7V, 25A; 3.3V, 35A Maximum output power: 450W Orientation: All except upside down and vertical with the airflow downwards Cooling: Standard fan, forward airflow. Comments: Fan grill not fitted.</p> <p>Model: NS-WKR/V4AFS 5/5H1H/1HFN 12/12H3/3F 5/5H1H/1HFN 28/25H5/4F (K40107) Input: 90-264Vac, 47-63Hz Maximum outputs: 5.5V, 2.5A; 5.5V, 2.5A; 12.5V, 2.5A; 12.5V, 2.5A; 5.5V, 2.5A; 5.5V, 2.5A; 28V, 1.5A; 26V, 1.5A Maximum output power: 198.5W Orientation: All except upside down and vertical with the airflow downwards Cooling: Papst 612NML or 612NMLE fan. Comments: Forward air.</p> <p>Model: NS-TLG/V6RFS 3.3F1SV5 24C5S W5FSV3 W8FSV8 (K60221*) where * may be any number of letters and/or numbers indicating non-safety related differences. Input: 100-240Vac nom, 120-350Vdc max Maximum output power: As standard model Orientation: As standard model Cooling: Reverse air.</p> <p>Model: NS-TLG/V6RFS12FW 3.3F1SV5 24C5S W5FSV3 W8FSV8 (K60220*) where * may be any number of letters and/or numbers indicating non-safety related differences. Input: 100-240Vac nom. May also have 120-350Vdc. Maximum output power: As standard model</p>
--

Enclosures

Miscellaneous ID 07-03

Orientation: As standard model
Cooling: Reverse air.

Model: NS-LAM/V6RFS 3.3F1SV5 12/12H3/3S W5FSV3 W8FSV8 (K60184*) where * may be any number of letters and/or numbers indicating non-safety related differences.
Input: 100-240Vac nom. May also have 120-350Vdc.
Maximum output power: As standard model
Orientation: As standard model
Cooling: Reverse air.

Model: NS-TLC/V9QSLF 24C5SN 12Z20S (K90064*) where * may be A or B.
Input: 100-240Vac nom. See table below for details
Maximum output power: See table below for details
Orientation: As standard model

OP1	OP1	OP2	OP2	AMB	LINE	STBY	STBY	POWER
V	A max	V	A max	max	V min	V	mA	W max
24	7	12	50	40	150	5	100	769
24	2.084	12	50	40	90	5	100	651
24	7	12	46.67	50	150	5	100	729
24	3.75	12	46.67	50	90	5	100	651
24	7	12	60	40	150	5	100	889
24	0	12	60	40	90	5	100	721

Model: NS-TLC/V9QSLF 24C5SN 12Z20S (K90064*) where * may be any number of letters and/or numbers except A or B, indicating non-safety related differences.
Fan: EBM-Papst 612NME
Input: 100-240Vac nom. See table below for details
Maximum output power: See table below for details

OP1	OP1	OP2	OP2	AMB	LINE	STBY	STBY	POWER
V	A max	V	A max	max	V min	V	mA	W max
24	7	12	50	40	150	5	100	769
24	2.084	12	50	40	90	5	100	651
24	3.75	12	46.67	40	90	5	100	651

Model: NS-TLU/V9FSLF 5.2/5.2H1H/1H 24D5SN 24D5SN (K90056*) where * may be any letter (except A or B) indicating non-safety related differences.
5.2/5.2H1H/1H channel 1 current limit increased to 150% (18A).

Additional application considerations – (Considerations used to test a component or sub-assembly) –

Customer Air Cooling (option C):

The following method must be used for determining the safe operation of PSUs when C option (Customer Air) is fitted, i.e. fan not fitted to PSU.

For PSUs cooled by customer supplied airflow the components listed in the following table must not exceed the temperatures given. Additionally ratings specified for units with an internal fan must still be complied with, e.g. mains input voltage range, maximum output power, ampere turns, module voltage / current ratings and maximum ambient temperature. To determine the component temperatures the heating tests must be conducted in accordance with the requirements of the standards this report complies with. Consideration should also be given to the requirements of other safety standards.

Enclosures

Miscellaneous ID 07-03

Test requirements include: PSU to be fitted in its end-use equipment and operated under the most adverse conditions permitted in the end-use equipment handbook/specification and which will result in the highest temperatures in the PSU. To determine the most adverse conditions consideration should be given to the end use equipment maximum operating ambient, the PSU loading and input voltage, ventilation, end use equipment orientation, the position of doors & covers, etc. Temperatures should be monitored using type K fine wire thermocouples (secured with cyanoacrylate adhesive, or similar) placed on the hottest part of the component (out of any direct airflow) and the equipment should be run until all temperatures have stabilised.

Circuit Ref. ++	Description	Max. Temp (°C)+
-	Power transformer primary, secondary and core	130
T1, TX101, TX201	Module current transformer windings	127 (130)
XQ1, XT1	D, E, EV, F & FV Primary option transformers	90
XTR1	EY, FY, EV & FV Primary option transformers	90
TX1	xEW & xFW Primary option transformers	130
L1, L2, XT601	Choke winding	110 (130)
L4, T2	Choke winding	117 (130)
Various	All other choke & transformer windings	110 (130)
RLY1	Relay	100
Various	X capacitor	100
C2, C3, C14	Electrolytic Capacitor	67 (105)
Various	All other 10mm dia Electrolytic Capacitors	80 (105)
Various	All other 12.5mm dia Electrolytic Capacitors	85 (105)

+ The higher temperature limits in brackets may be used but product life may be reduced.
 ++ When fitted

Enclosures

Miscellaneous ID 07-04

Additional application considerations – (Considerations used to test a component or sub-assembly) –

Customer Air Cooling (option C):

The following method must be used for determining the safe operation of PSUs when C option (Customer Air) is fitted, i.e. fan not fitted to PSU.

For PSUs cooled by customer supplied airflow the components listed in the following table must not exceed the temperatures given. Additionally ratings specified for units with an internal fan must still be complied with, e.g. mains input voltage range, maximum output power, ampere turns, module voltage / current ratings and maximum ambient temperature. To determine the component temperatures the heating tests must be conducted in accordance with the requirements of the standards this report complies with. Consideration should also be given to the requirements of other safety standards.

Test requirements include: PSU to be fitted in its end-use equipment and operated under the most adverse conditions permitted in the end-use equipment handbook/specification and which will result in the highest temperatures in the PSU. To determine the most adverse conditions consideration should be given to the end use equipment maximum operating ambient, the PSU loading and input voltage, ventilation, end use equipment orientation, the position of doors & covers, etc. Temperatures should be monitored using type K fine wire thermocouples (secured with cyanoacrylate adhesive, or similar) placed on the hottest part of the component (out of any direct airflow) and the equipment should be run until all temperatures have stabilised.

Circuit Ref. ++	Description	Max. Temp (°C)+
-	Power transformer primary, secondary and core	130
T1, TX101, TX201	Module current transformer windings	127 (130)
XQ1, XT1	D, E, EV, F & FV Primary option transformers	90
XTR1	EY, FY, EV & FV Primary option transformers	90
TX1	xEW & xFW Primary option transformers	130
L1, L2, XT601	Choke winding	110 (130)
L4, T2	Choke winding	117 (130)
Various	All other choke & transformer windings	110 (130)
RLY1	Relay	100
Various	X capacitor	100
C2, C3, C14	Electrolytic Capacitor	67 (105)
Various	All other 10mm dia Electrolytic Capacitors	80 (105)
Various	All other 12.5mm dia Electrolytic Capacitors	85 (105)

+ The higher temperature limits in brackets may be used but product life may be reduced.
 ++ When fitted

Technical Considerations

The product was submitted and evaluated for use at the maximum ambient temperature (Tma) permitted by the manufacturer's specification of: 50°C

The product is intended for use on the following power systems : TN,TT

The following were investigated as part of the protective earthing/bonding: Printed wiring board trace (refer to Enclosure - Schematics + PWB for layouts)

Enclosures

Miscellaneous ID 07-04

<p>The following are available from the Applicant upon request: Installation (Safety) Instructions / Manual</p> <p>Engineering Conditions of Acceptability</p> <p>When installed in an end-product, consideration must be given to the following:</p> <p>The following Production-Line tests are conducted for this product: Electric Strength Earthing Continuity</p> <p>Mains supply tolerance (%) or absolute mains supply values : +10%/-10% for AC and DC input</p> <p>When the IEC inlet option is fitted (option I) together with a plastic fan grill then the end face of the PSU with the fan grill may be operator accessible.</p> <p>The end-product Electric Strength Test is to be based upon a maximum working voltage of: AC mains supply Primary-Earthed Dead Metal: 298Vrms, 392Vpk , Primary-Secondary: 328Vrms, 504Vpk. DC mains supply:- Primary to earth 560Vpk, 383Vrms. Primary to secondary, 563Vpeak, 350Vrms</p> <p>The following secondary output circuits are ES1: See "ES ratings and Outputs Connected in Series" under model differences.</p> <p>The following output circuits are at PS3 energy levels: ALL</p> <p>The power supply terminals and/or connectors are: Suitable for factory wiring only (except the IEC inlet "I option")</p> <p>The maximum investigated branch circuit rating is: 20 A</p> <p>The investigated Pollution Degree is: 2</p> <p>Proper bonding to the end-product main protective earthing termination is: Required</p> <p>An investigation of the protective bonding terminals has: Been conducted</p> <p>The following magnetic devices (e.g. transformers or inductor) are provided with an OBJY2 insulation system with the indicated rating greater than Class A (105°C): Main barrier and 1A Primary option transformers OBJY3: Class F.</p> <p>The following end-product enclosures are required: Mechanical, Fire, Electrical</p> <p>The power supply was evaluated for operation at a maximum of 5000m, excluding the IEC60320 inlet and cooling options d and e which are rated up to 3000m.</p> <p>Cooling option C requires components monitoring as detailed in "Additional application considerations" section above.</p> <p>The Customer fixings screw penetration require special attention: see handbook in enclosures for details.</p>
--