

CCG10-48-xxS

EVALUATION DATA

型式データ

INDEX

	PAGE
1. 測定方法 Evaluation Method	
1-1. 測定回路 Measurement Circuits	3
(1) 静特性、待機電力特性、通電ドリフト特性、その他特性 Steady state, Standby power, Warm up voltage drift and Other characteristics	
(2) 入力サージ電流(突入電流)波形 Inrush current waveform	
(3) 出力リップルノイズ電圧、波形 Output ripple and noise voltage and waveform	
(4) EMI特性 Electro-Magnetic Interference characteristics	
1-2. 使用測定機器 List of equipment used	5
2. 特性データ Characteristics	
2-1. 静特性 Steady state characteristics	
(1) 入力・負荷・温度変動 Regulation - line and load, Temperature drift	6
(2) 出力電圧・出力リップルノイズ電圧 対 入力電圧 Output voltage and Output ripple and noise voltage vs. Input voltage	7
(3) 入力電流・効率 対 出力電流 Input current and Efficiency vs. Output current	9
(4) 効率 対 入力電圧 Efficiency vs. Input voltage	11
(5) 起動・遮断電圧特性 Start up and Drop out voltage characteristics	13
2-2. 待機電力特性 Standby power characteristics	15
2-3. 通電ドリフト特性 Warm up voltage drift characteristics	17
2-4. 過電流保護特性 Over current protection (OCP) characteristics	19
2-5. 出力立ち上がり・立ち下がり特性 Output rise and fall characteristics	21
2-6. 過渡応答(負荷急変)特性 Dynamic load response characteristics	29
2-7. 入力サージ電流(突入電流)特性 Inrush current characteristics	30
2-8. 出力リップルノイズ波形 Output ripple and noise waveform	31
2-9. EMI特性 Electro-Magnetic Interference characteristics	32

使用記号 Terminology used

	定義	Definition
V_{in} 入力電圧	Input voltage
V_o 出力電圧	Output voltage
V_{RC} RC電圧	RC voltage
I_{in} 入力電流	Input current
I_o 出力電流	Output current
T_a 周囲温度	Ambient temperature
f 周波数	Frequency

※ 当社測定条件における結果であり、参考値としてお考え願います。
Test results are reference data based on our measurement condition.

1. 測定方法 Evaluation Method

1-1. 測定回路 Measurement Circuits

(1) 静特性、待機電力特性、通電ドリフト特性、その他特性

Steady state, Standby power, Warm up voltage drift and Other characteristics

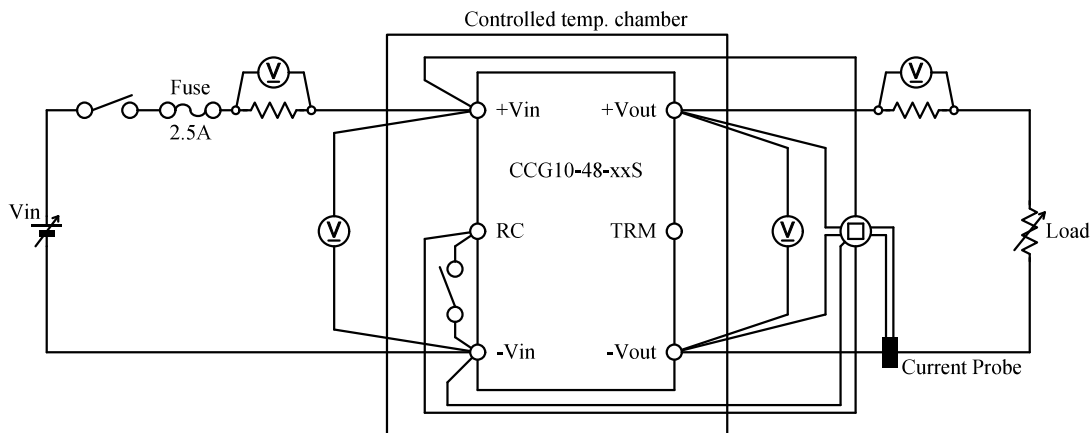

(2) 入力サージ電流 (突入電流) 波形 Inrush current waveform

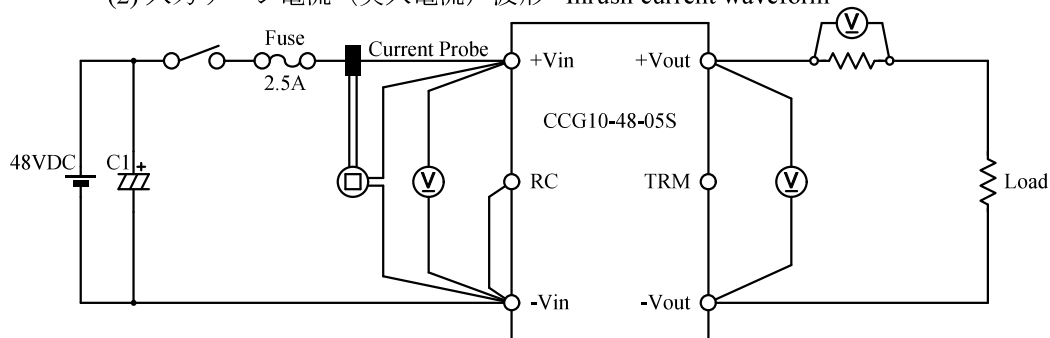

CCG10-48-xxSの入力サージ電流特性はCCG10-48-05Sと同等です。

CCG10-48-xxS have the same Inrush current characteristics as CCG10-48-05S data.

(3) 出力リップルノイズ電圧、波形 Output ripple and noise voltage and waveform

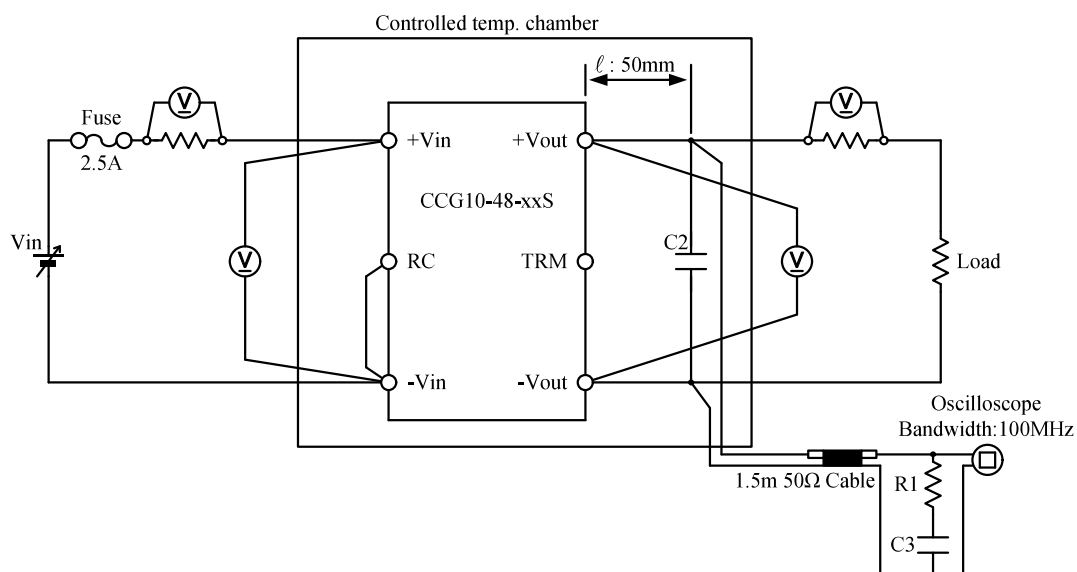

- C1 : 4000uF Electrolytic Capacitor
- C2 : 1uF Ceramic Capacitor
- C3 : 4700pF Ceramic Capacitor
- R1 : 50Ω

(4) EMI特性 Electro-Magnetic Interference characteristics

(a) 雑音端子電圧(帰還ノイズ) Conducted Emission Noise

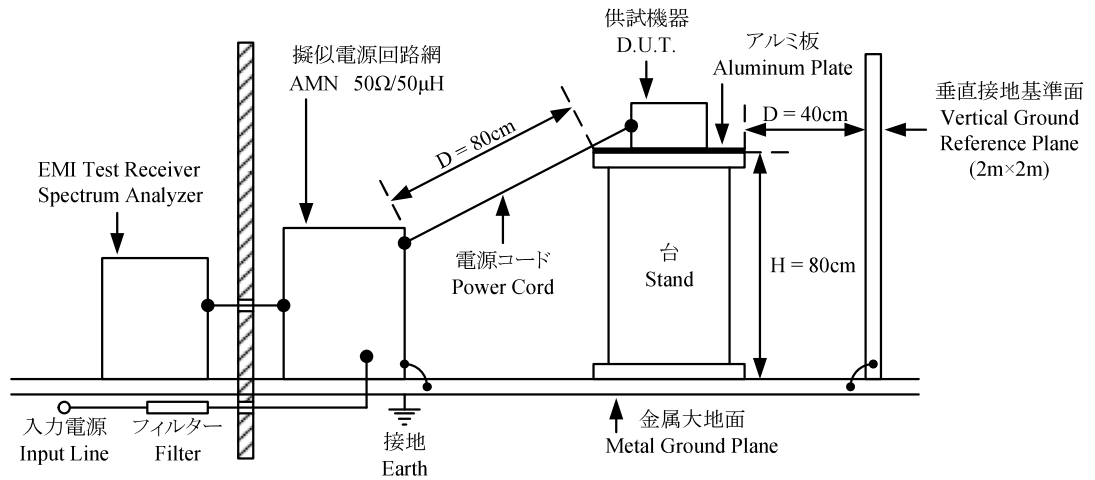

(b) 雑音電界強度(輻射ノイズ) Radiated Emission Noise

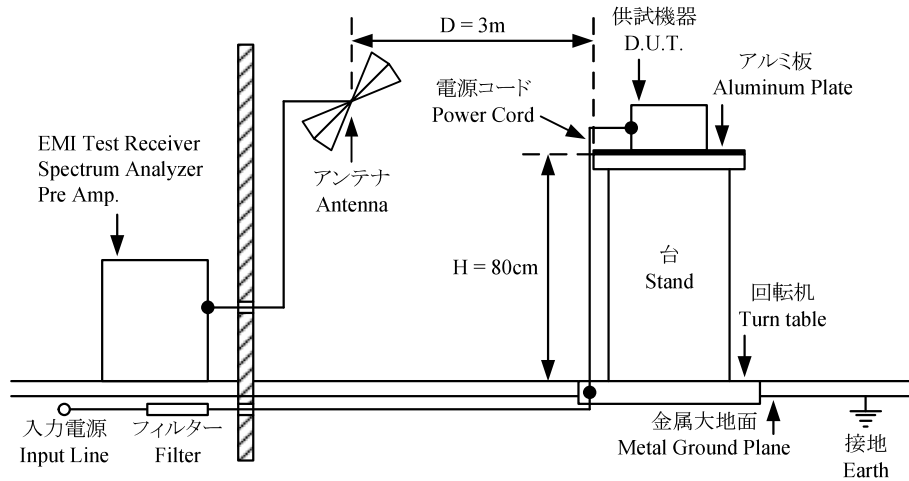

VCCI class A 対応アプリケーション VCCI class A application system

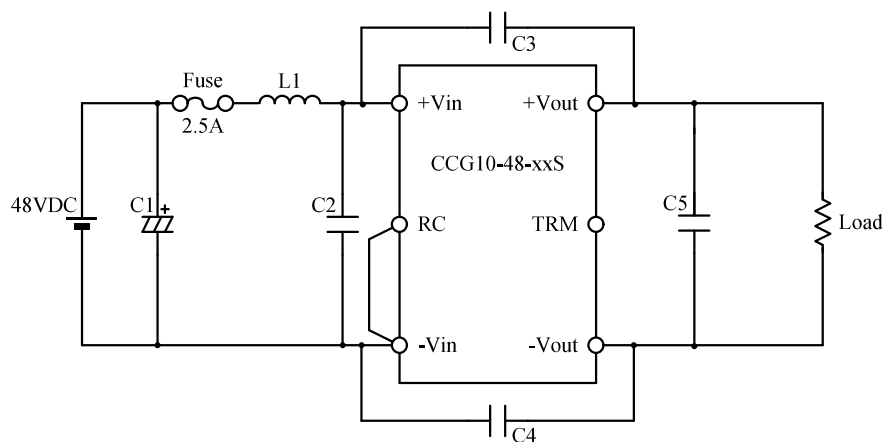

- | | | | |
|----|--------------|------------------------|---------------------------------------|
| C1 | : 100V 39uF | Electrolytic Capacitor | (ELXV101ELL390MH20D,Nippon Chemi-con) |
| C2 | : 100V 2.2uF | Ceramic Capacitor | (C3216X7S2A225KT,TDK) |
| C3 | : 2kV 1000pF | Ceramic Capacitor | (C3225X7S3D102K200AA,TDK) |
| C4 | : 2kV 1000pF | Ceramic Capacitor | (C3225X7S3D102K200AA,TDK) |
| C5 | : 25V 10uF | Ceramic Capacitor | (C3216X7R1E106KT,TDK) |
| L1 | : 1.4A 22uH | Normal Mode Choke Coil | (LQH5BPN220MT0L,MURATA) |

1-2. 使用測定機器 List of equipment used

	EQUIPMENT USED	MANUFACTURER	MODEL NO.
1	DIGITAL STORAGE OSCILLOSCOPE	YOKOGAWA ELECT.	DL1740E / DL1740EL
2	DIGITAL MULTIMETER	AGILENT	34970A
3	CURRENT PROBE	YOKOGAWA ELECT.	701932
4	CURRENT PROBE	AGILENT	N2774A
5	SHUNT RESISTER	YOKOGAWA ELECT.	2215
6	DYNAMIC DUMMY LOAD	KIKUSUI	PLZ-164WL
7	CVCF	NF	ES10000S
8	DC POWER SUPPLY	TDK-Lambda	GEN80-9.5 / GENH80-9.5
9	DC POWER SUPPLY	TAKASAGO	EX-750H2
10	CONTROLLED TEMP. CHAMBER	ESPEC	SU-261 / SU-262
11	EMI TEST RECEIVER / SPECTRUM ANALYZER	ROHDE & SCHWARZ	ESR3
12	PRE AMP.	SONOMA	310N
13	AMN	KIKUSUI	KNW-242C
14	ANTENNA	SCHWARZBECK	BBA9106/VHA9103
15	ANTENNA	SCHWARZBECK	UHALP9107

2. 特性データ Characteristics

2-1. 静特性 Steady state characteristics

(1) 入力・負荷・温度変動 Regulation - line and load, Temperature drift

3.3V

1. Regulation - line and load

Condition Ta : 25 °C

Io \ Vin	18VDC	24VDC	48VDC	76VDC	Line regulation	
0%	3.3060V	3.3062V	3.3062V	3.3060V	0.2mV	0.006%
50% (1.3A)	3.3057V	3.3058V	3.3057V	3.3056V	0.2mV	0.006%
100% (2.6A)	3.3054V	3.3054V	3.3053V	3.3052V	0.2mV	0.006%
Load regulation	0.6mV	0.8mV	0.9mV	0.8mV		
	0.018%	0.024%	0.027%	0.024%		

2. Temperature drift

Conditions Vin : 48 VDC

Io : 100 %

Ta	-40°C	25°C	60°C	Temperature stability	
Vo	3.3093V	3.3053V	3.3039V	5.4mV	0.164%

5V

1. Regulation - line and load

Condition Ta : 25 °C

Io \ Vin	18VDC	24VDC	48VDC	76VDC	Line regulation	
0%	4.9821V	4.9823V	4.9823V	4.9822V	0.2mV	0.004%
50% (1A)	4.9825V	4.9826V	4.9827V	4.9829V	0.4mV	0.008%
100% (2A)	4.9836V	4.9835V	4.9835V	4.9836V	0.1mV	0.002%
Load regulation	1.5mV	1.2mV	1.2mV	1.4mV		
	0.030%	0.024%	0.024%	0.028%		

2. Temperature drift

Conditions Vin : 48 VDC

Io : 100 %

Ta	-40°C	25°C	65°C	Temperature stability	
Vo	4.9755V	4.9835V	4.9903V	14.8mV	0.296%

12V

1. Regulation - line and load

Condition Ta : 25 °C

Io \ Vin	18VDC	24VDC	48VDC	76VDC	Line regulation	
0%	12.0455V	12.0476V	12.0436V	12.0419V	5.7mV	0.047%
50% (0.45A)	12.0443V	12.0450V	12.0447V	12.0397V	5.3mV	0.044%
100% (0.9A)	12.0466V	12.0470V	12.0459V	12.0449V	2.1mV	0.018%
Load regulation	2.3mV	2.6mV	2.3mV	5.2mV		
	0.019%	0.022%	0.019%	0.043%		

2. Temperature drift

Conditions Vin : 48 VDC

Io : 100 %

Ta	-40°C	25°C	65°C	Temperature stability	
Vo	12.0311V	12.0459V	12.0575V	26.4mV	0.220%

15V

1. Regulation - line and load

Condition Ta : 25 °C

Io \ Vin	18VDC	24VDC	48VDC	76VDC	Line regulation	
0%	15.0613V	15.0643V	15.0619V	15.0616V	3.0mV	0.020%
50% (0.35A)	15.0611V	15.0620V	15.0606V	15.0563V	5.7mV	0.038%
100% (0.7A)	15.0635V	15.0639V	15.0630V	15.0634V	0.9mV	0.006%
Load regulation	2.4mV	2.3mV	2.4mV	7.1mV		
	0.016%	0.015%	0.016%	0.047%		

2. Temperature drift

Conditions Vin : 48 VDC

Io : 100 %

Ta	-40°C	25°C	70°C	Temperature stability	
Vo	15.0414V	15.0630V	15.0774V	36.0mV	0.240%

(2) 出力電圧・出力リップルノイズ電圧 対 入力電圧

Output voltage and Output ripple and noise voltage vs. Input voltage

Conditions Io : 100 %
 Ta : -40 °C
 : 25 °C
 : 60 °C
 : 65 °C

3.3V

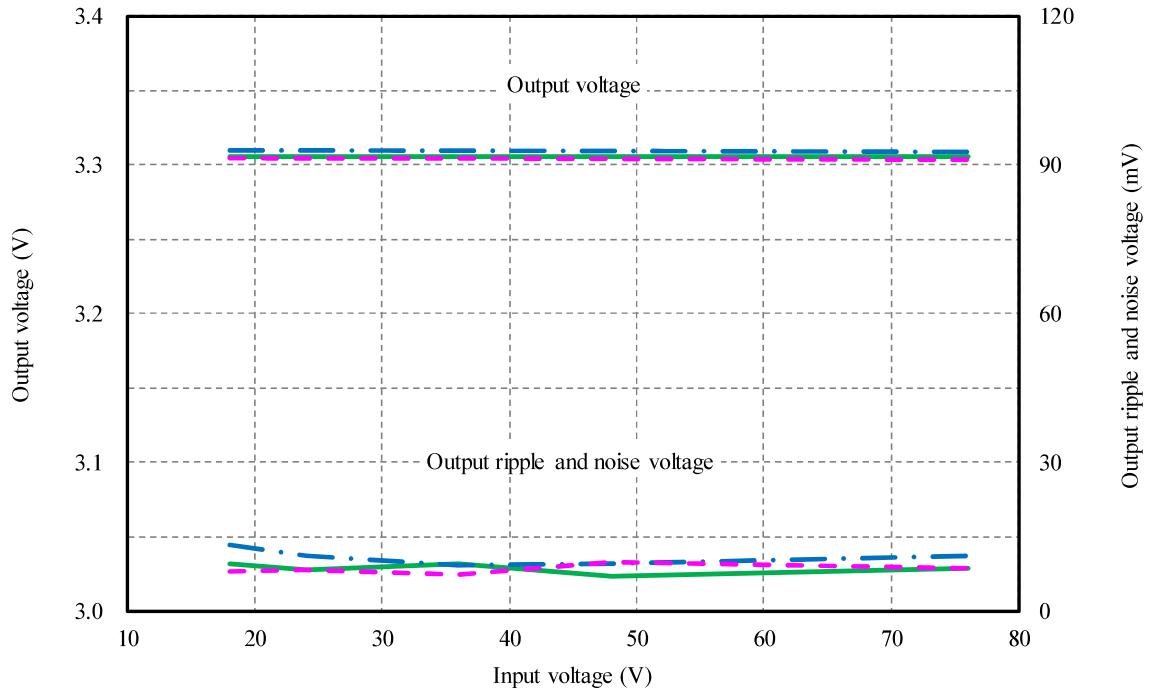

5V

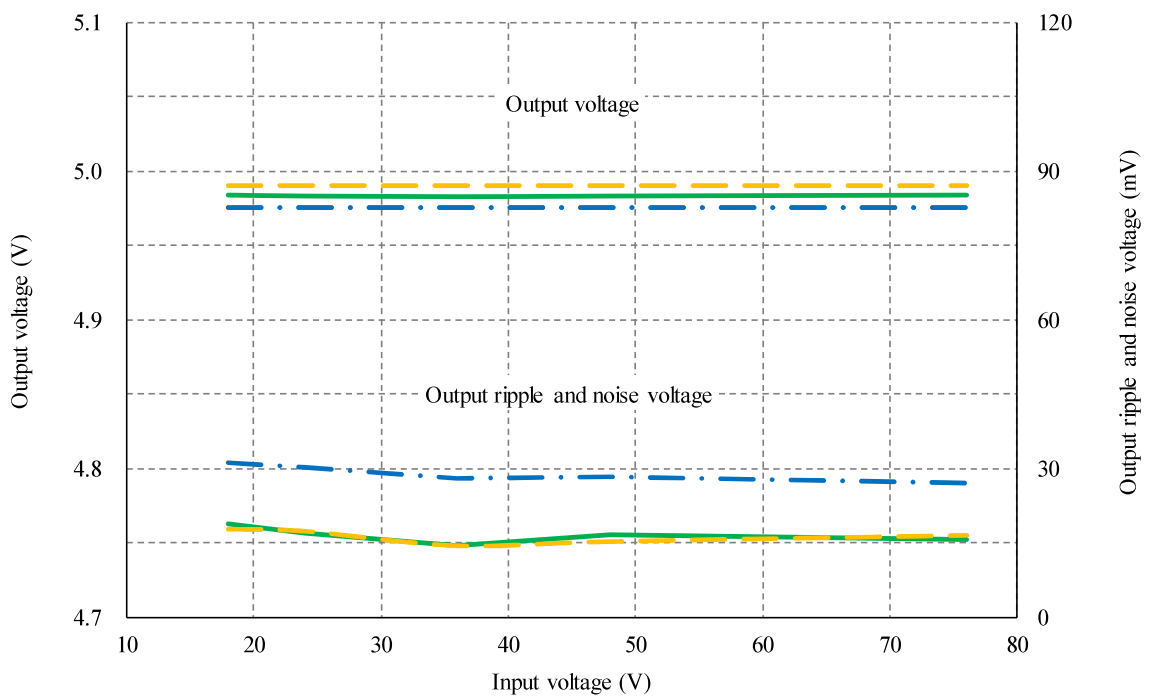

(2) 出力電圧・出力リップルノイズ電圧 対 入力電圧

Output voltage and Output ripple and noise voltage vs. Input voltage

Conditions Io : 100 %
 Ta : -40 °C
 : 25 °C
 : 65 °C
 : 70 °C

12V

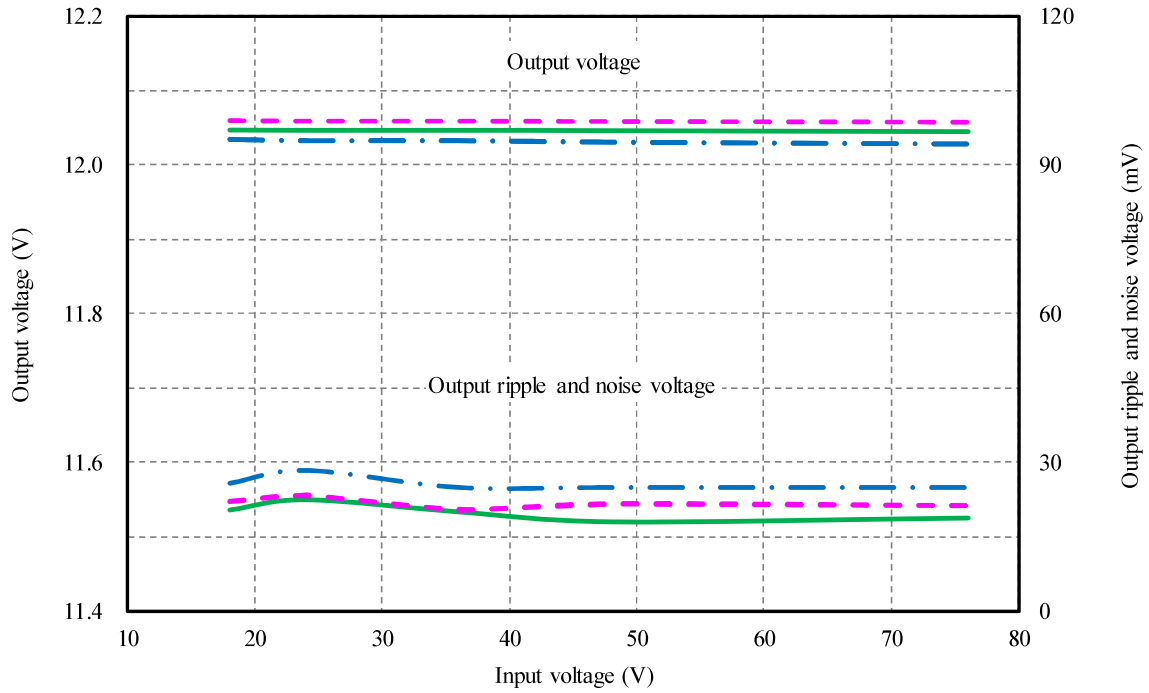

15V

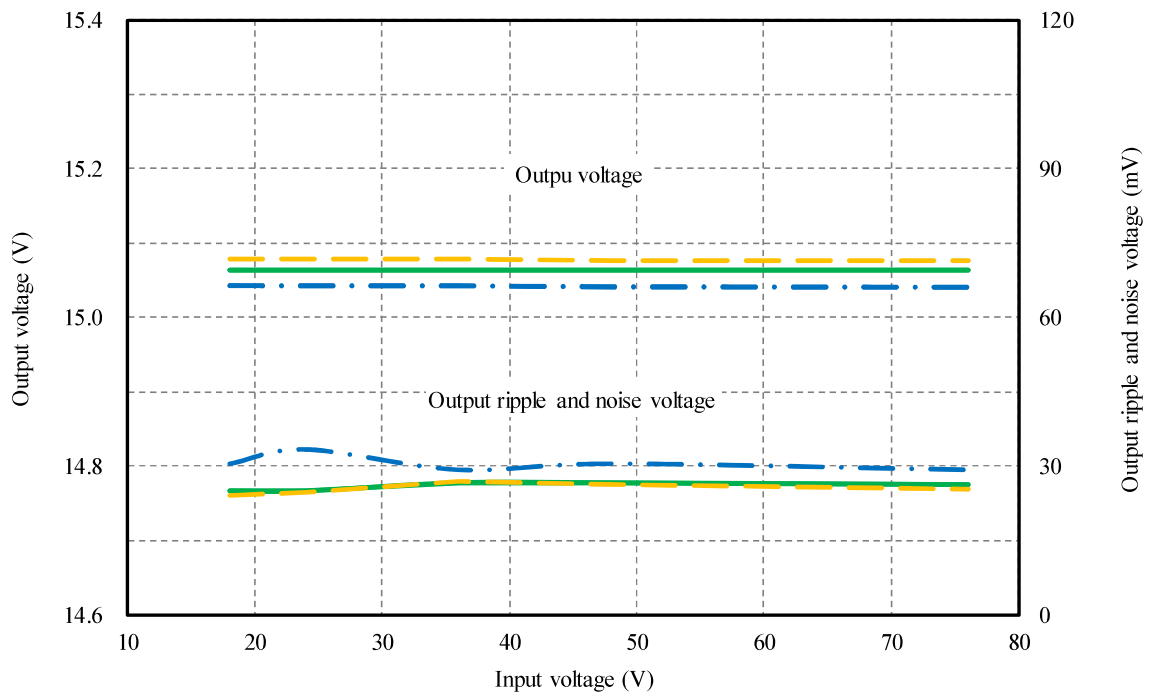

(3) 入力電流・効率 対 出力電流 Input current and Efficiency vs. Output current

Conditions Vin : 18 VDC ————
 : 24 VDC - · - · -
 : 48 VDC ————
 : 76 VDC - · - · -
 Ta : 25 °C

3.3V

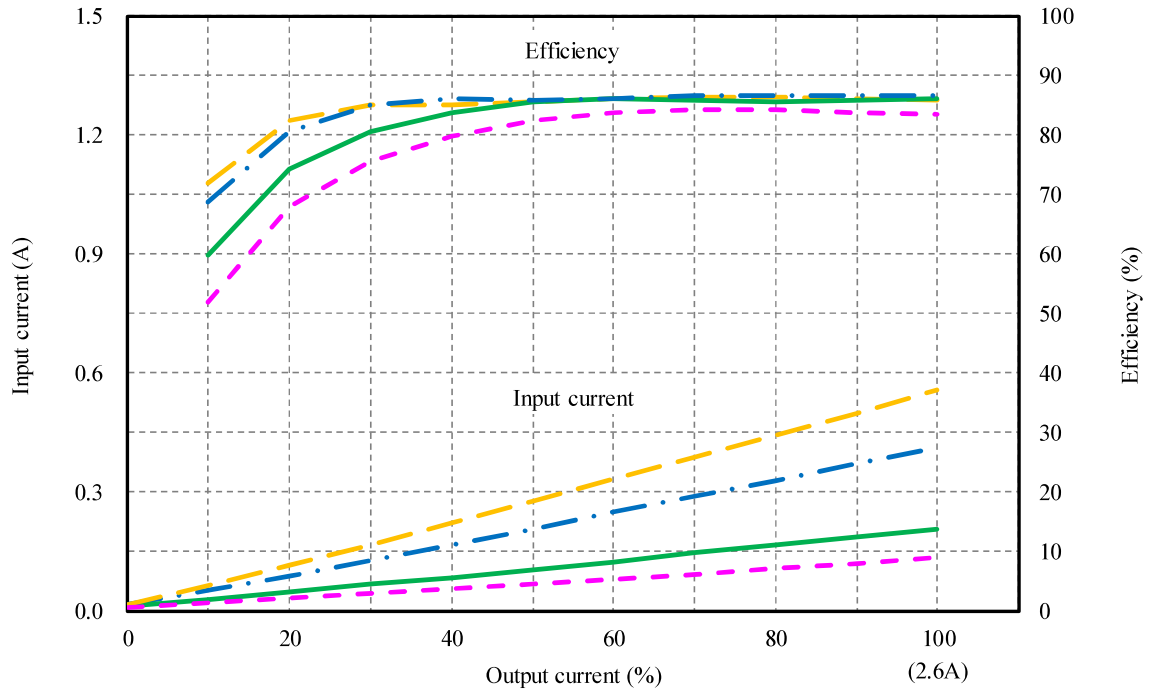

5V

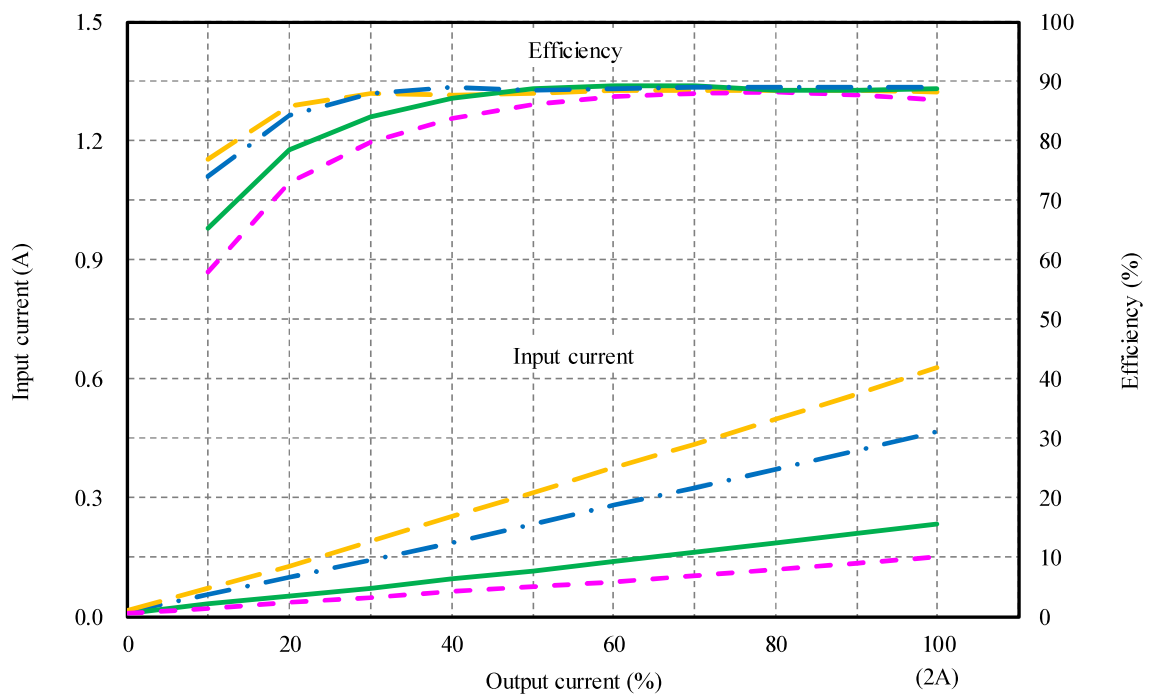

(3) 入力電流・効率 対 出力電流 Input current and Efficiency vs. Output current

Conditions Vin : 18 VDC ————
 : 24 VDC - · - · -
 : 48 VDC ————
 : 76 VDC - · - · -
 Ta : 25 °C

12V

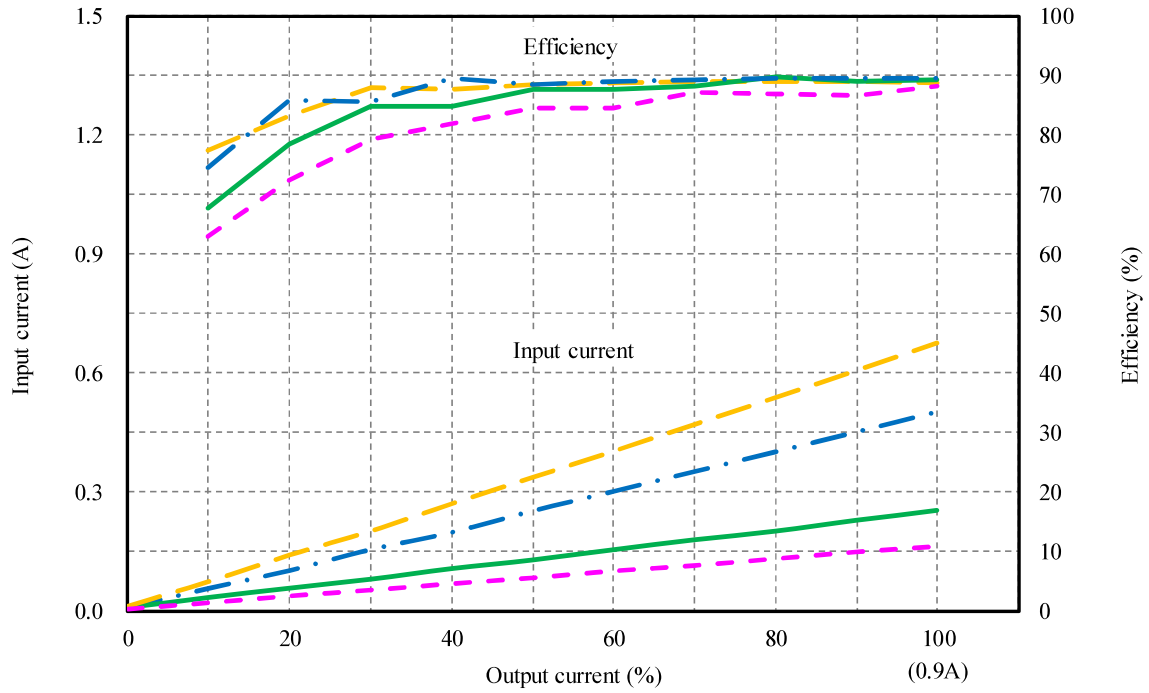

15V

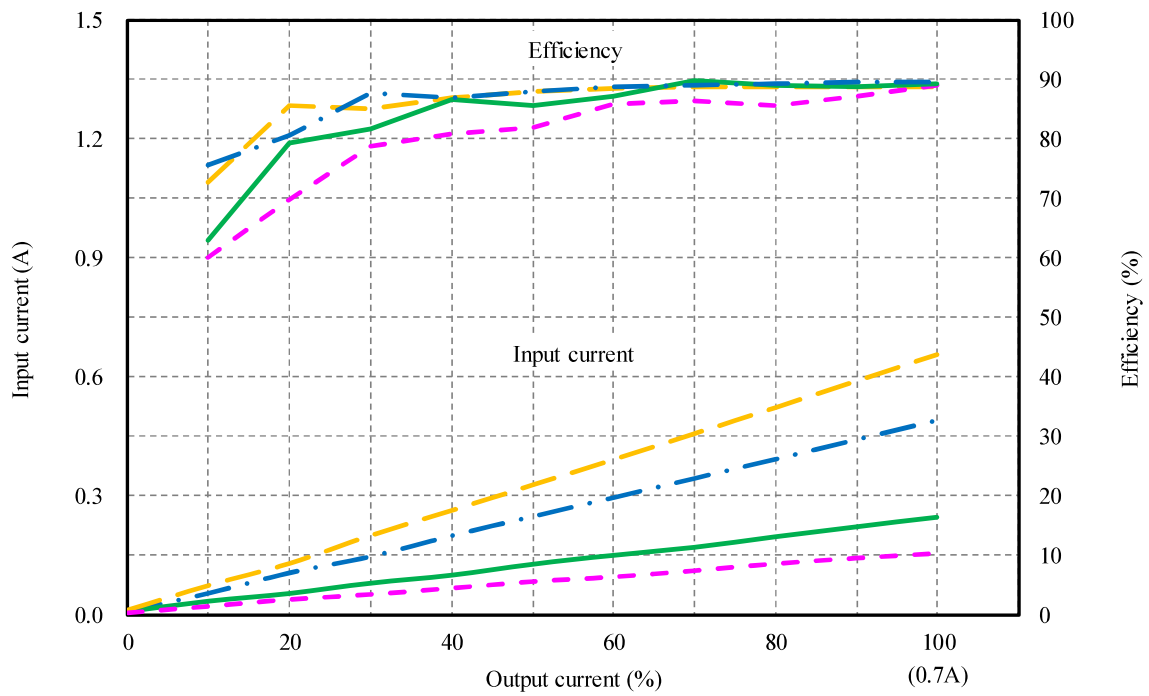

(4) 効率 対 入力電圧 Efficiency vs. Input voltage

Conditions Io : 50 % ---
 : 100 % —
 Ta : 25 °C

3.3V

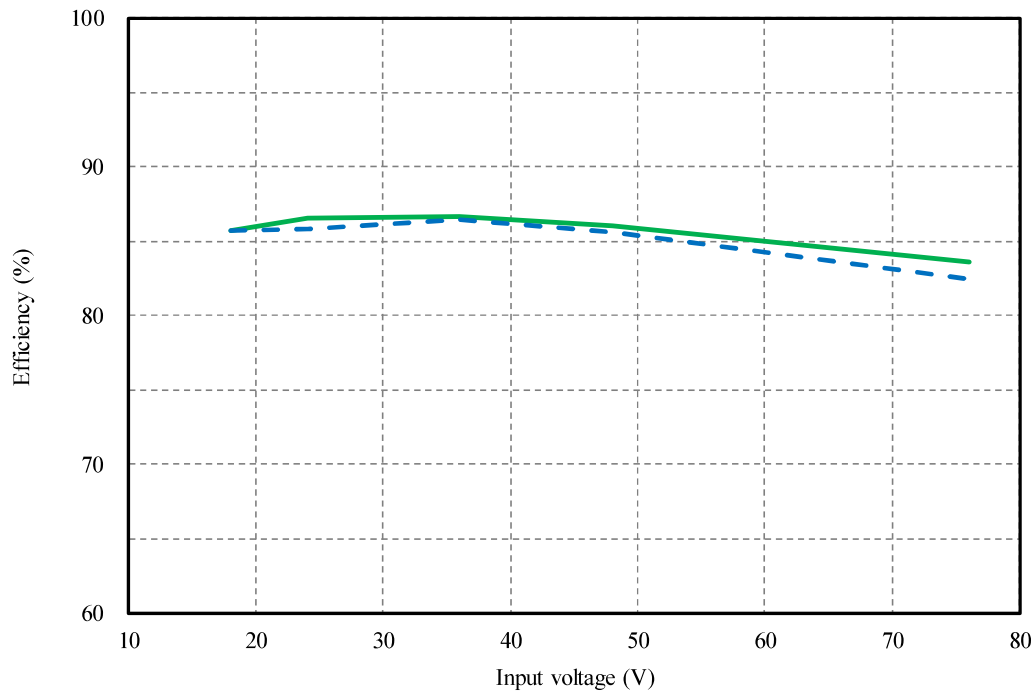

5V

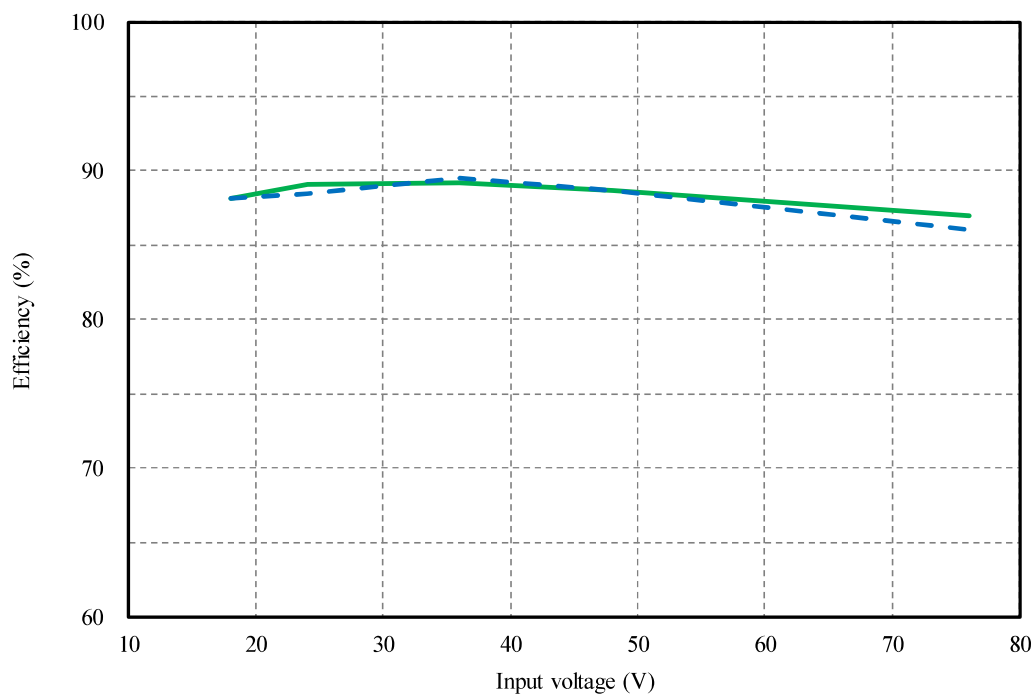

(4) 効率 対 入力電圧 Efficiency vs. Input voltage

Conditions Io : 50 % ---
 : 100 % —
 Ta : 25 °C

12V

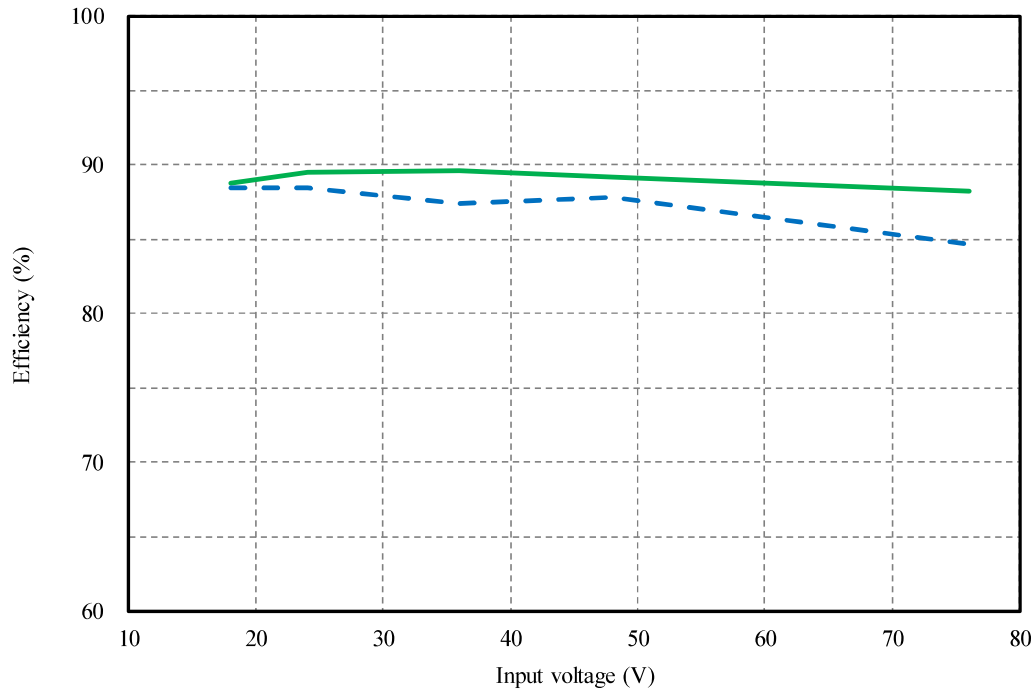

15V

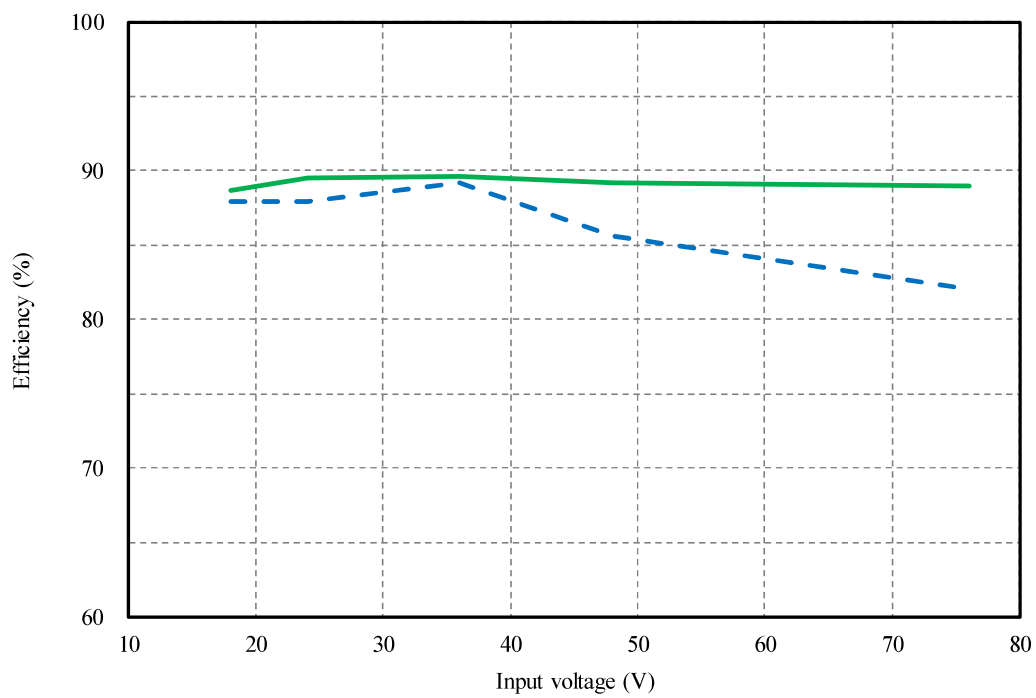

(5) 起動・遮断電圧特性 Start up and Drop out voltage characteristics

出力電圧 対 入力電圧

Output voltage vs. Input voltage

Conditions I_o : 100 %
 T_a : 25 °C

入力電流 対 入力電圧

Input current vs. Input voltage

Conditions I_o : 100 %
 T_a : 25 °C

3.3V

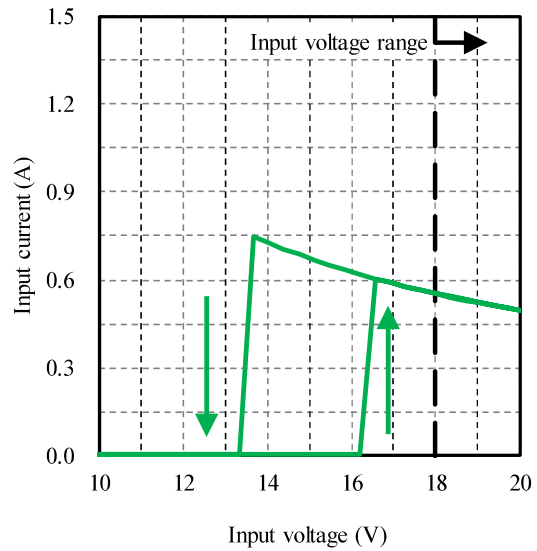
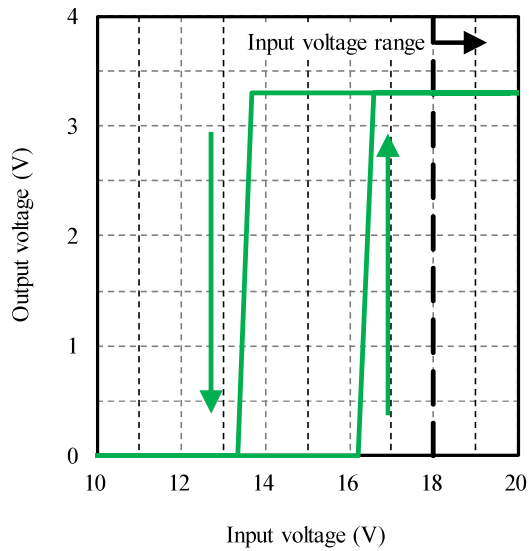

5V

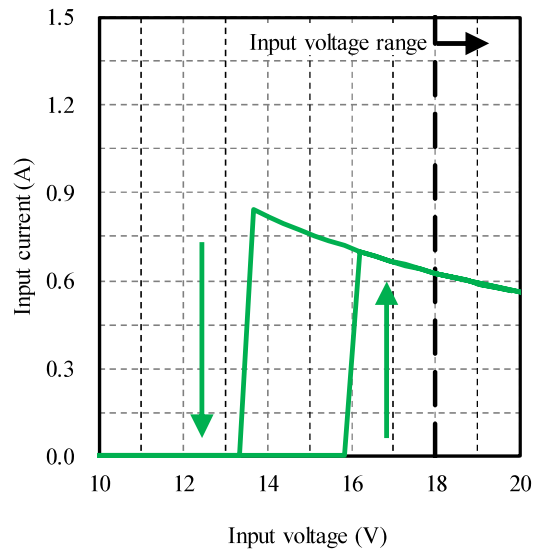
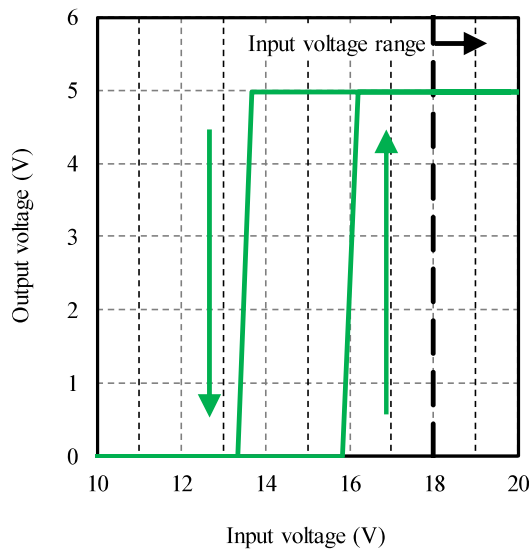

(5) 起動・遮断電圧特性 Start up and Drop out voltage characteristics

出力電圧 対 入力電圧

Output voltage vs. Input voltage

Conditions I_o : 100 %
 T_a : 25 °C

入力電流 対 入力電圧

Input current vs. Input voltage

Conditions I_o : 100 %
 T_a : 25 °C

12V

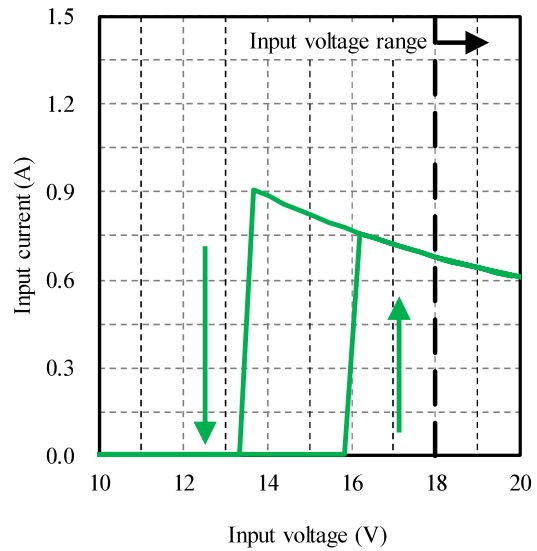
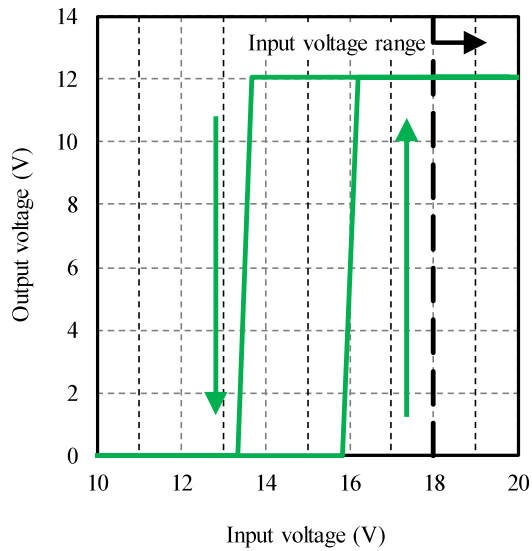

15V

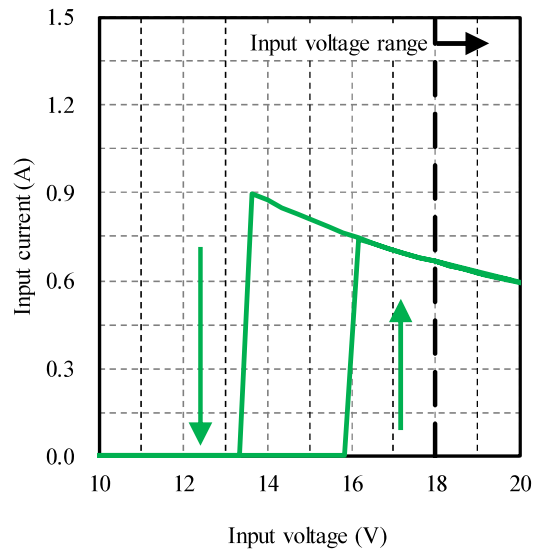
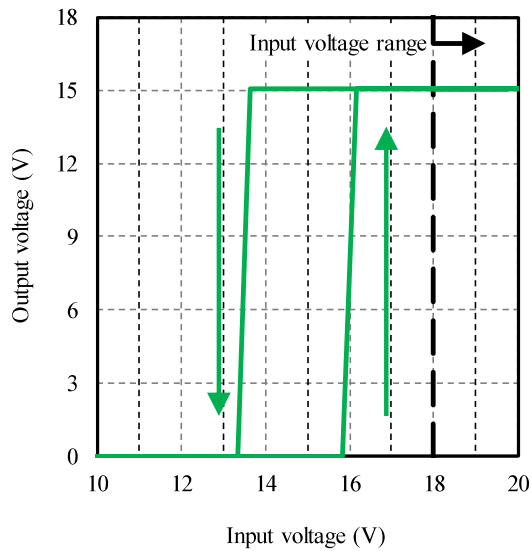

2-2. 待機電力特性 Standby power characteristics

Condition Ta : 25 °C

3.3V

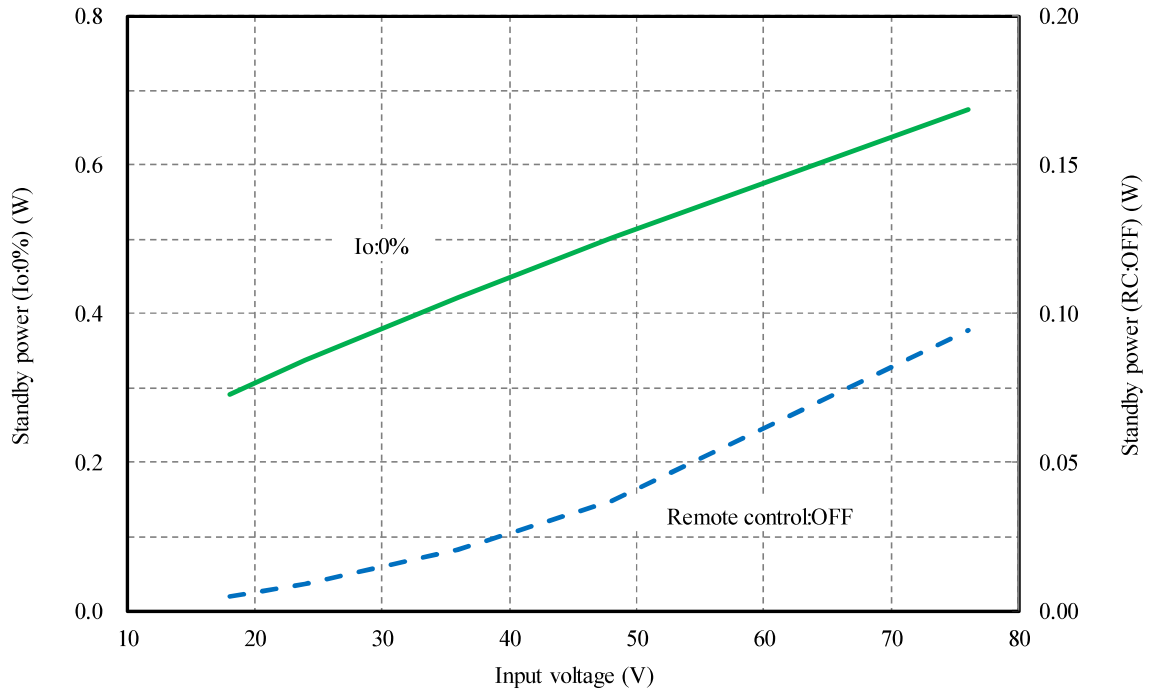

5V

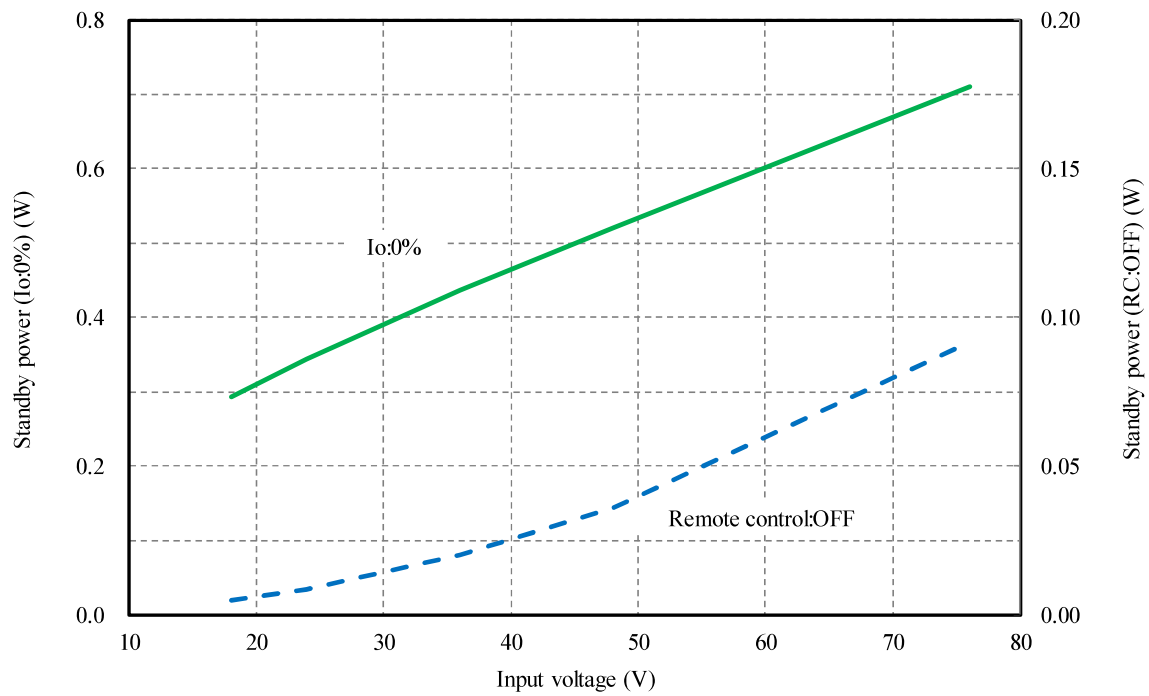

2-2. 待機電力特性 Standby power characteristics

Condition Ta : 25 °C

12V

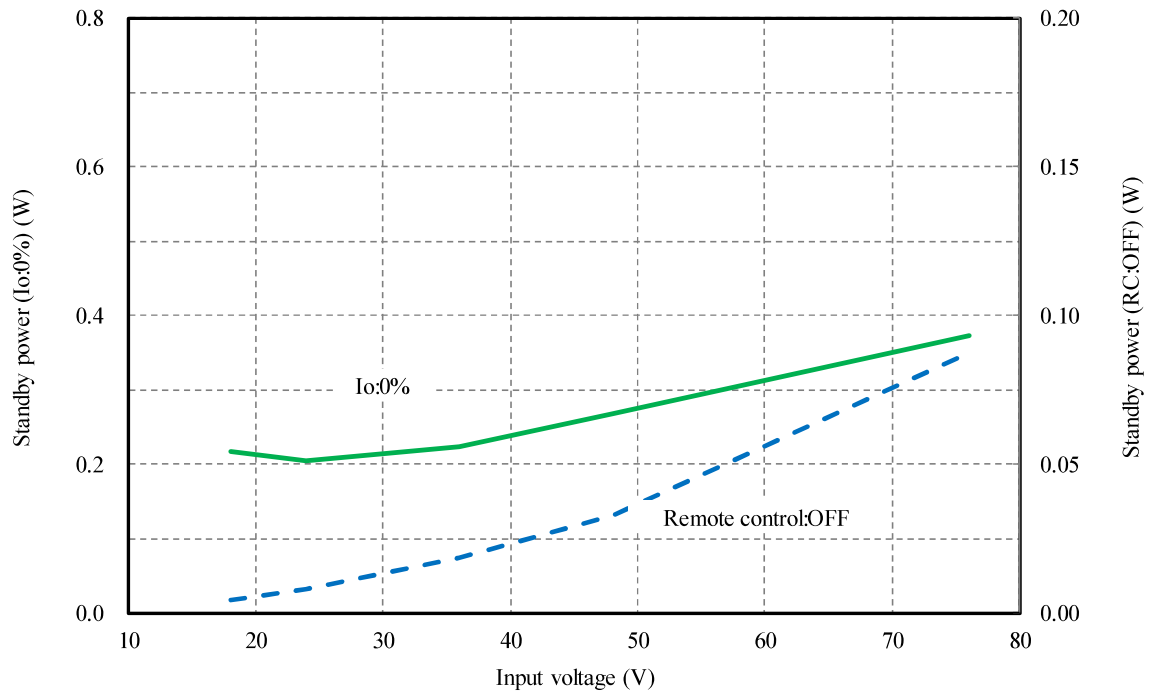

15V

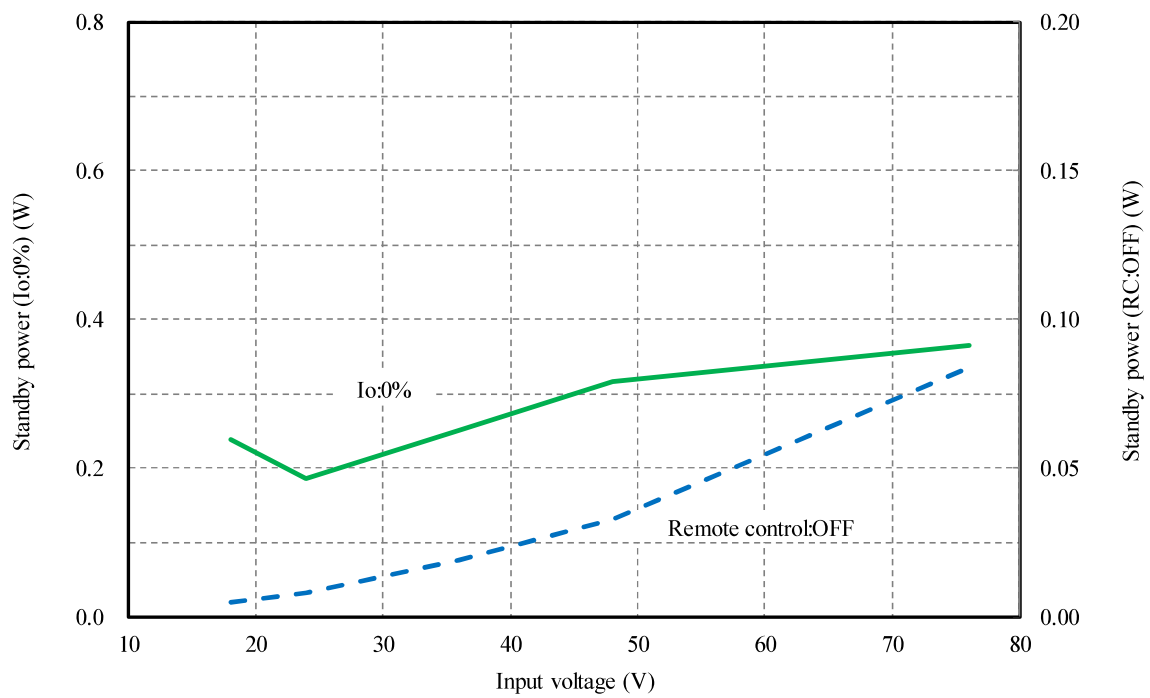

2-3. 通電ドリフト特性 Warm up voltage drift characteristics

Conditions Vin : 48 VDC
 Io : 100 %
 Ta : 25 °C

3.3V

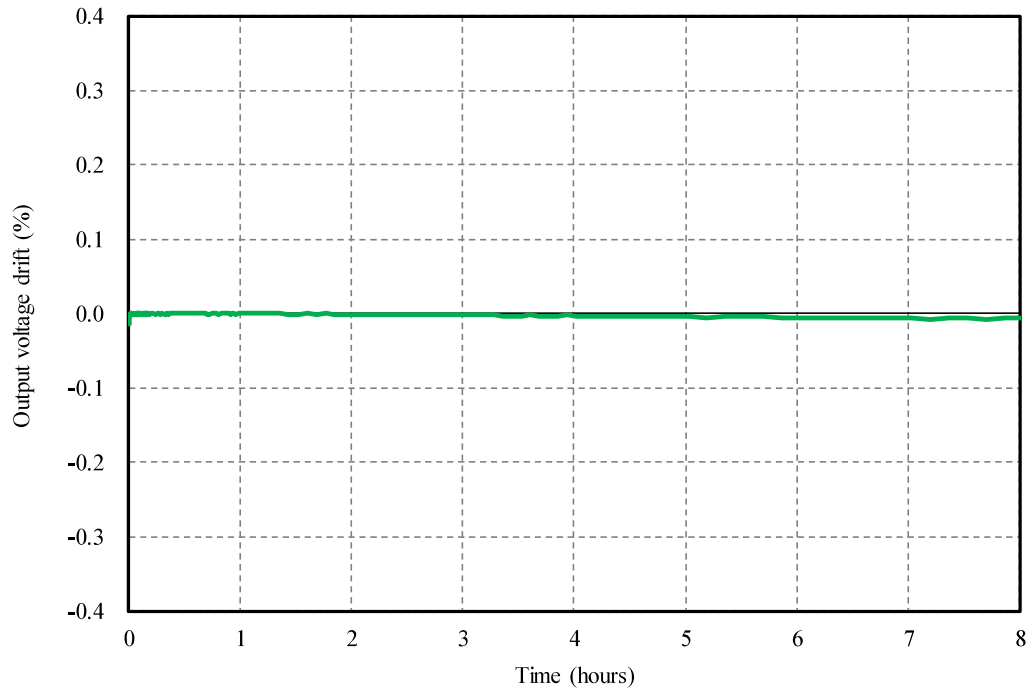

5V

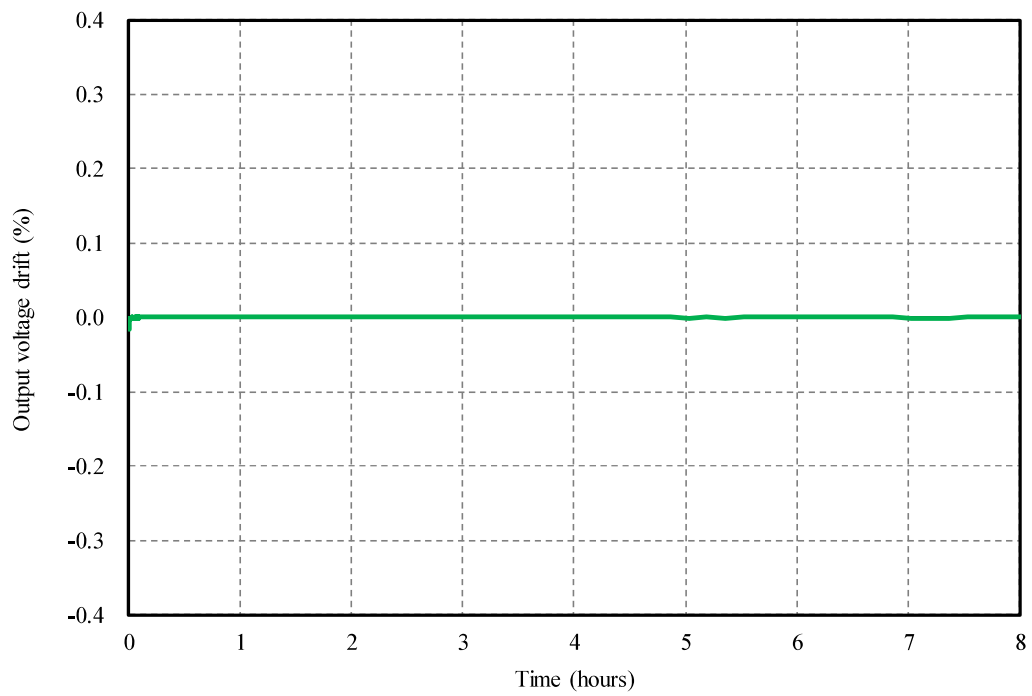

2-3. 通電ドリフト特性 Warm up voltage drift characteristics

Conditions Vin : 48 VDC
 Io : 100 %
 Ta : 25 °C

12V

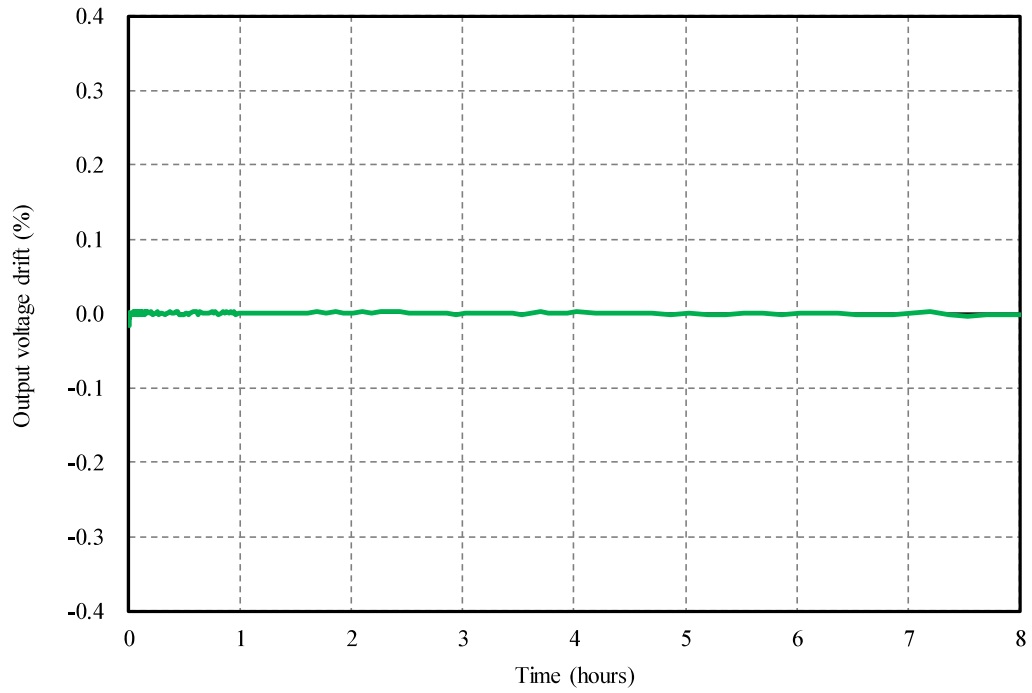

15V

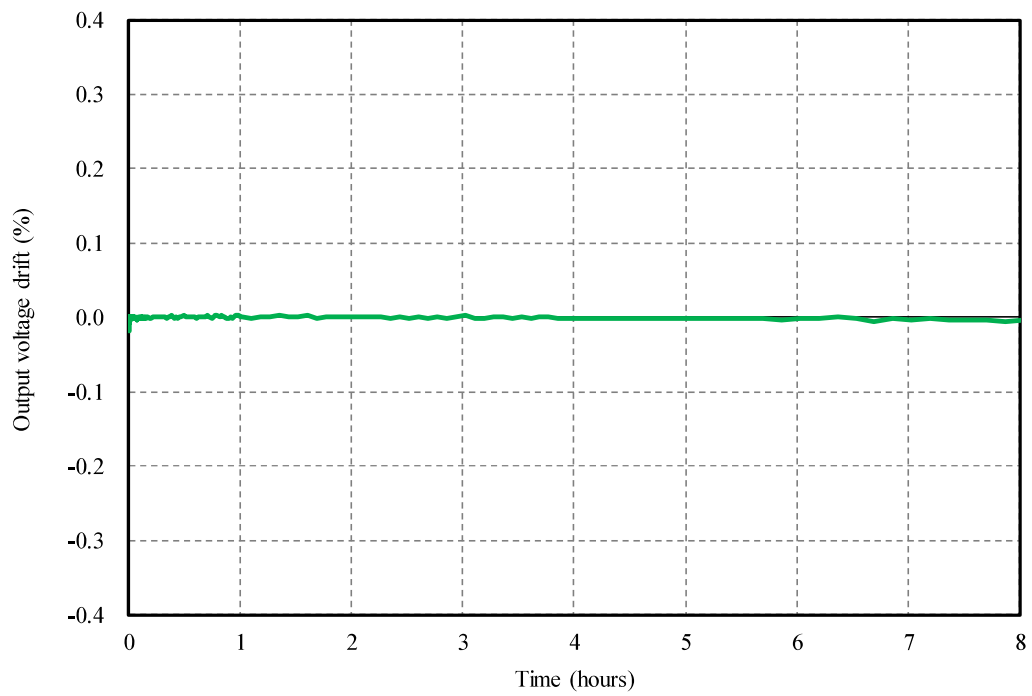

2-4. 過電流保護特性 Over current protection (OCP) characteristics

入力電圧依存性

Input voltage dependence

Conditions Vin : 18 VDC ———
 : 24 VDC - - -
 : 48 VDC ———
 : 76 VDC - - -
 Ta : 25 °C

周囲温度依存性

Ambient temperature dependence

Conditions Vin : 48 VDC
 Ta : -40 °C - - -
 : 25 °C ———
 : 60 °C - - -

3.3V

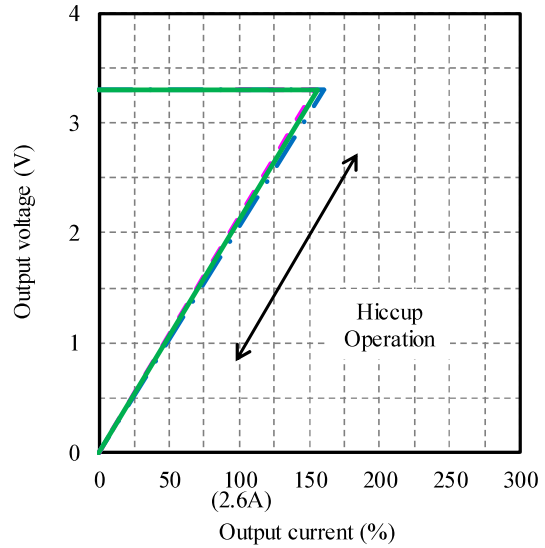
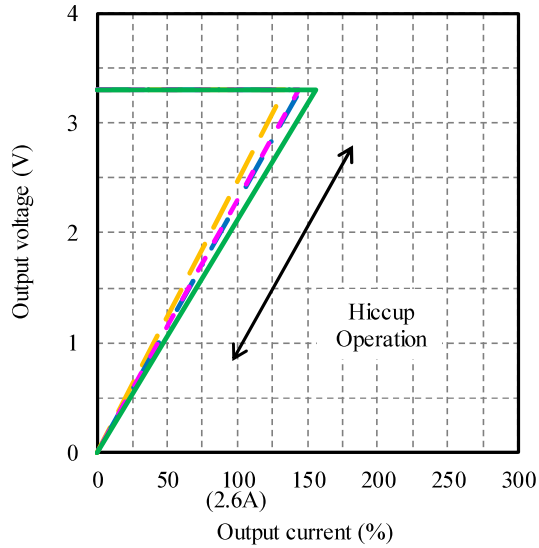

5V

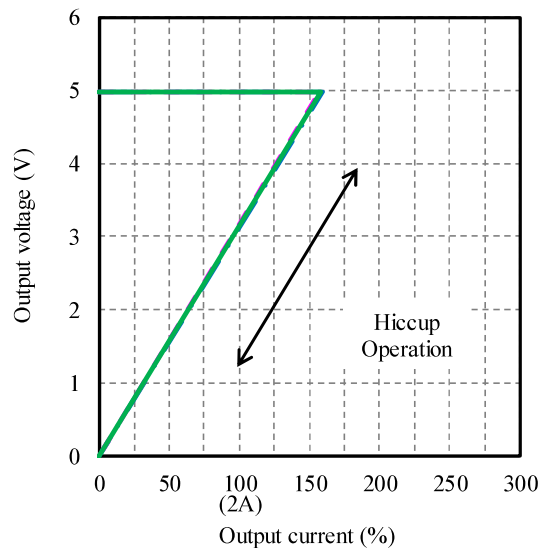
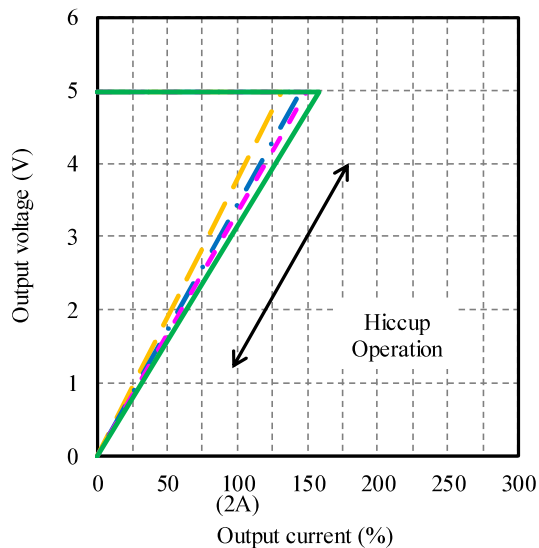

2-4. 過電流保護特性 Over current protection (OCP) characteristics

入力電圧依存性

Input voltage dependence

Conditions Vin : 18 VDC ———
 : 24 VDC - - -
 : 48 VDC ———
 : 76 VDC - - -
 Ta : 25 °C

周囲温度依存性

Ambient temperature dependence

Conditions Vin : 48 VDC
 Ta : -40 °C - - -
 : 25 °C ———
 : 65 °C - - -

12V

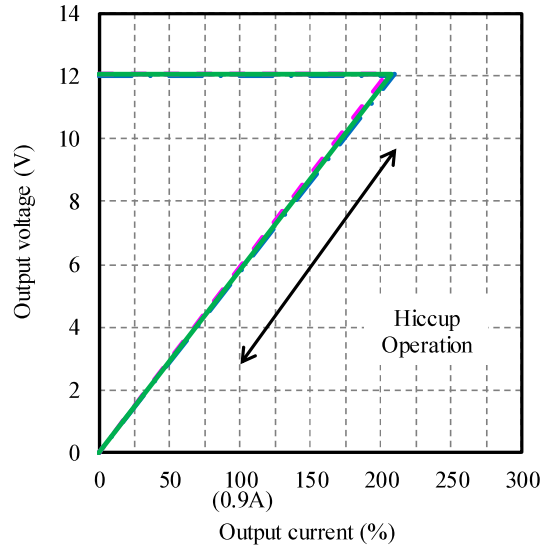
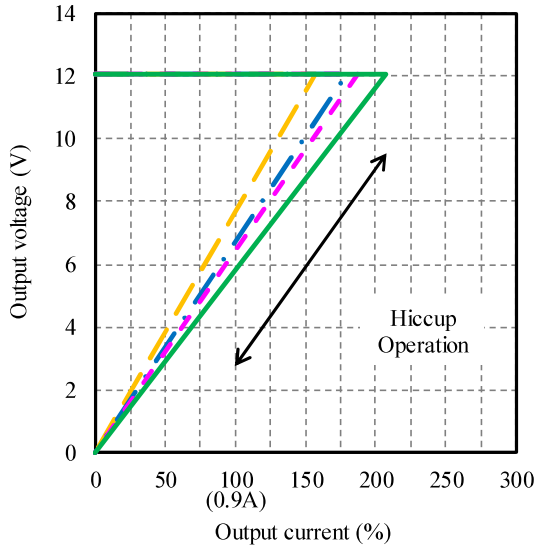

Conditions Vin : 18 VDC ———
 : 24 VDC - - -
 : 48 VDC ———
 : 76 VDC - - -
 Ta : 25 °C

Conditions Vin : 48 VDC
 Ta : -40 °C - - -
 : 25 °C ———
 : 70 °C - - -

15V

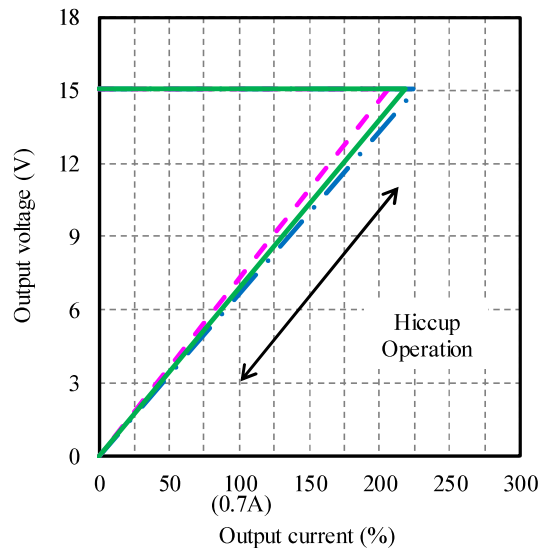
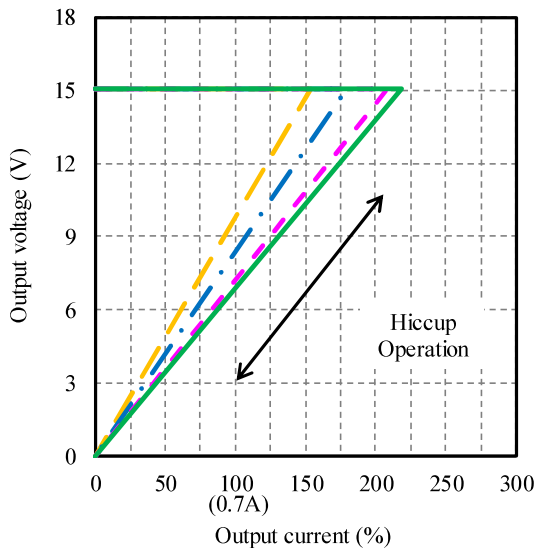

2-5. 出力立ち上がり・立ち下がり特性 Output rise and fall characteristics

Conditions V_{in} : 48 VDC
 I_o : 0 %
 T_a : 25 °C

3.3V

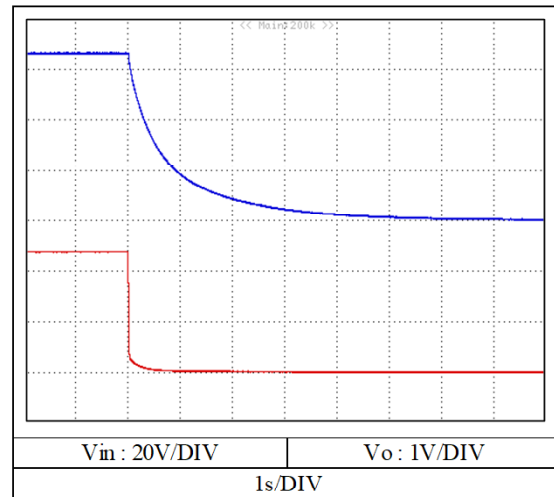
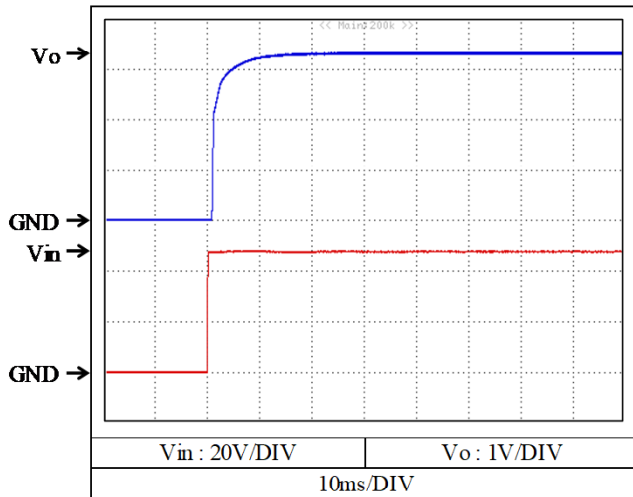

5V

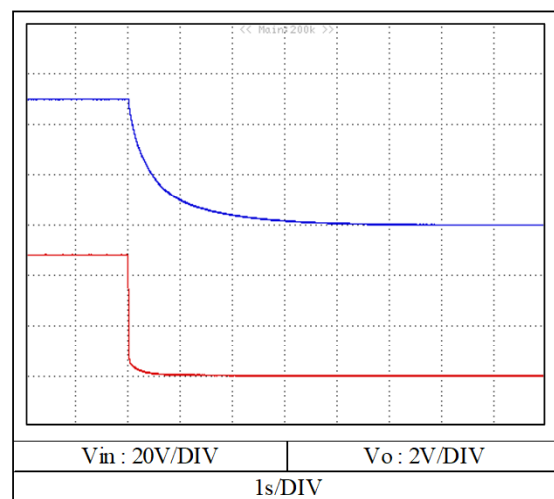
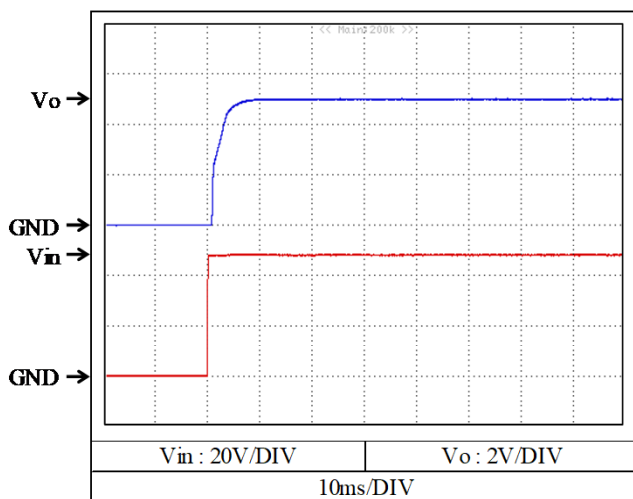

2-5. 出力立ち上がり・立ち下がり特性 Output rise and fall characteristics

Conditions V_{in} : 48 VDC
 I_o : 0 %
 T_a : 25 °C

12V

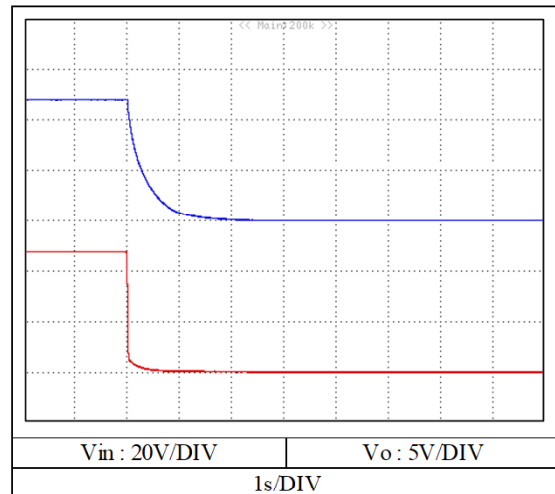
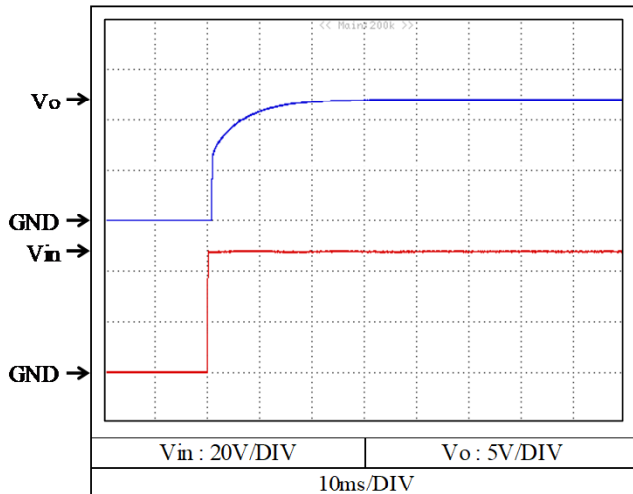

15V

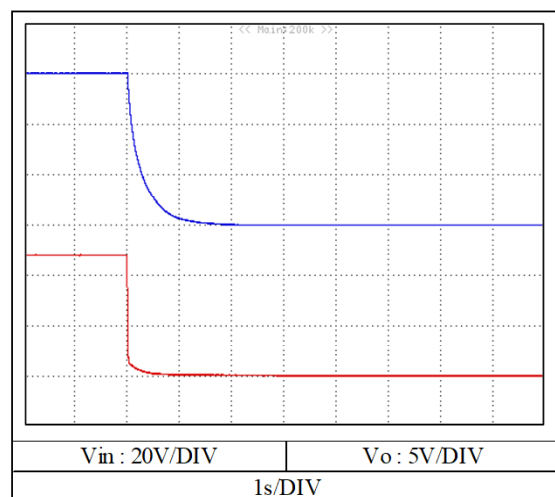
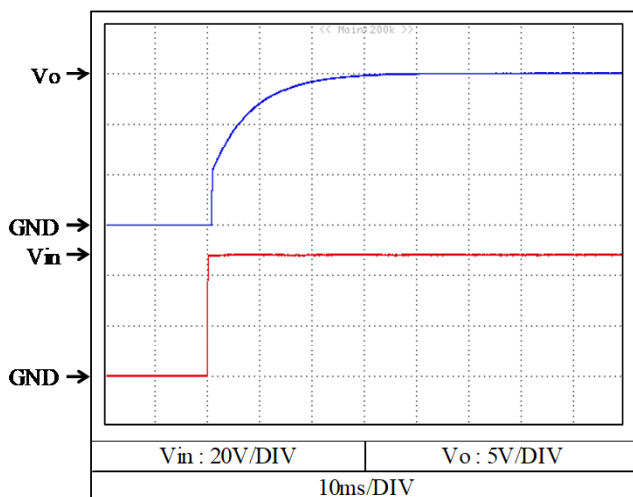

2-5. 出力立ち上がり・立ち下がり特性 Output rise and fall characteristics

Conditions V_{in} : 48 VDC
 I_o : 100 %
 T_a : 25 °C

3.3V

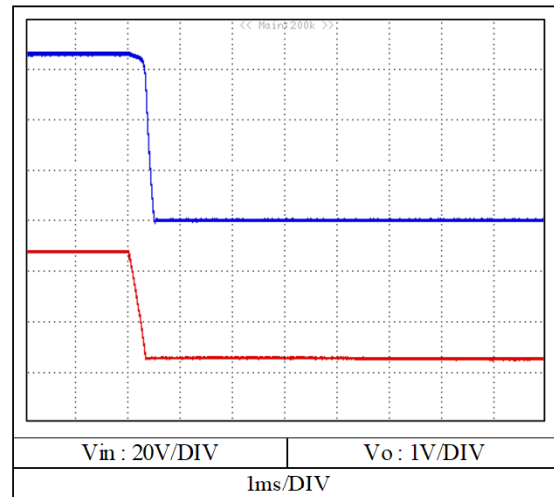
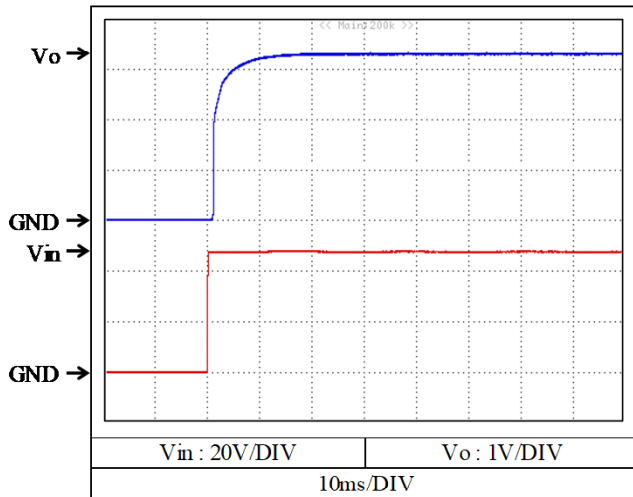

5V

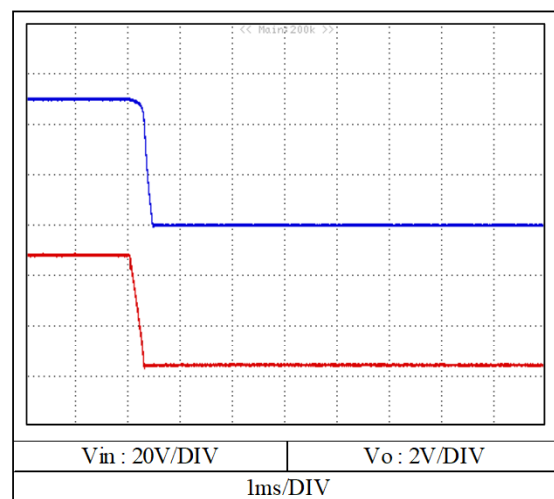
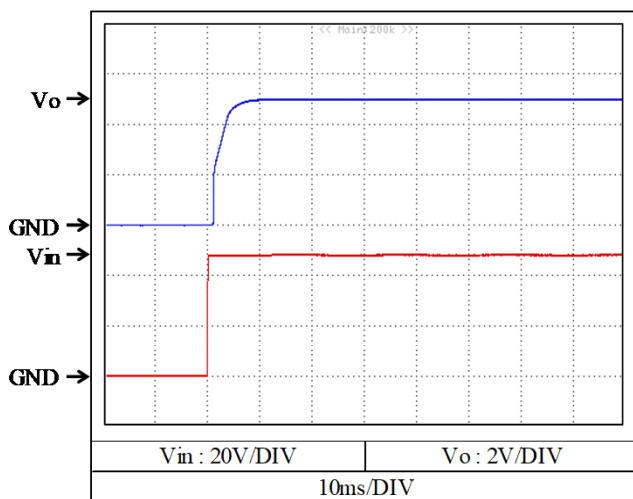

2-5. 出力立ち上がり・立ち下がり特性 Output rise and fall characteristics

Conditions V_{in} : 48 VDC
 I_o : 100 %
 T_a : 25 °C

12V

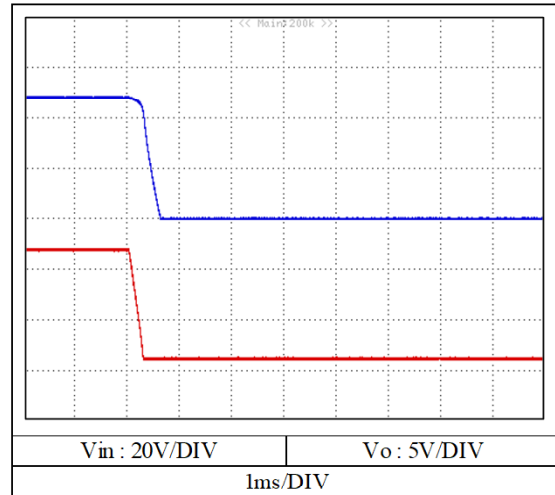
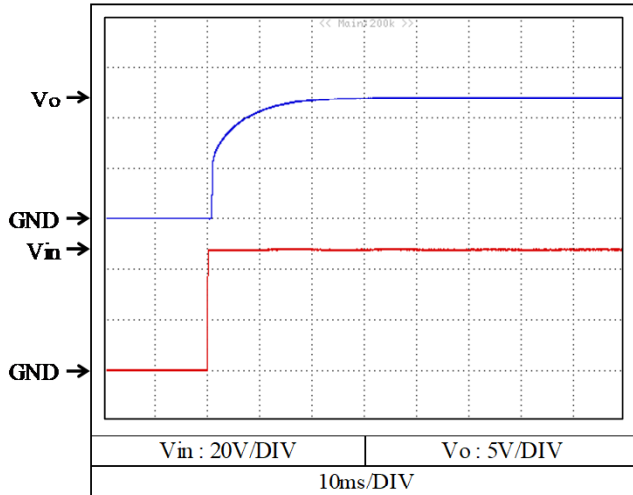

15V

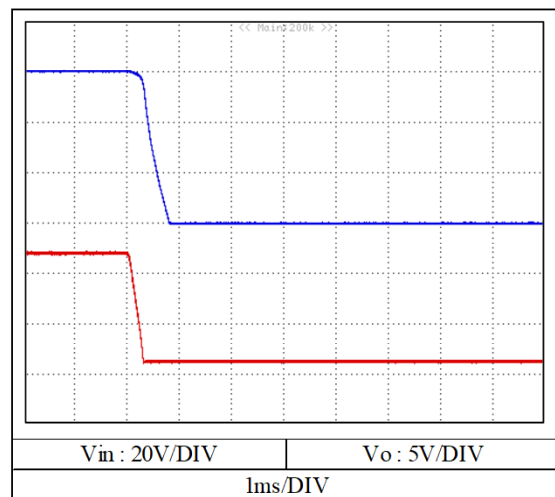
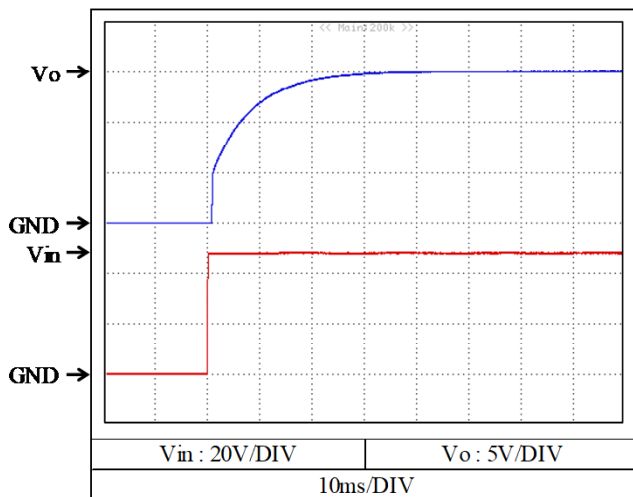

2-5. 出力立ち上がり・立ち下がり特性 (リモートON/OFFコントロール時)

Output rise and fall characteristics with REMOTE ON/OFF CONTROL

Conditions V_{in} : 48 VDC
 I_o : 0 %
 T_a : 25 °C

3.3V

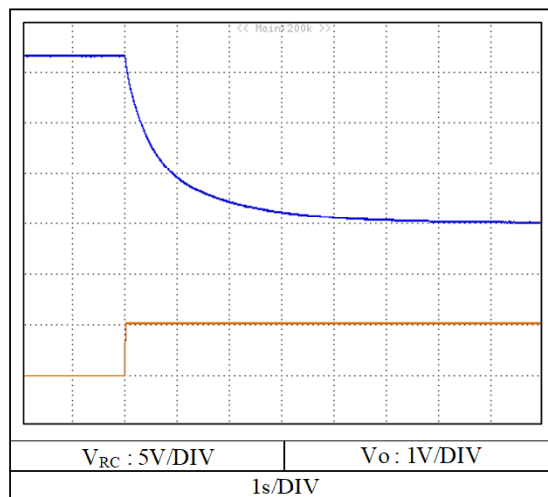
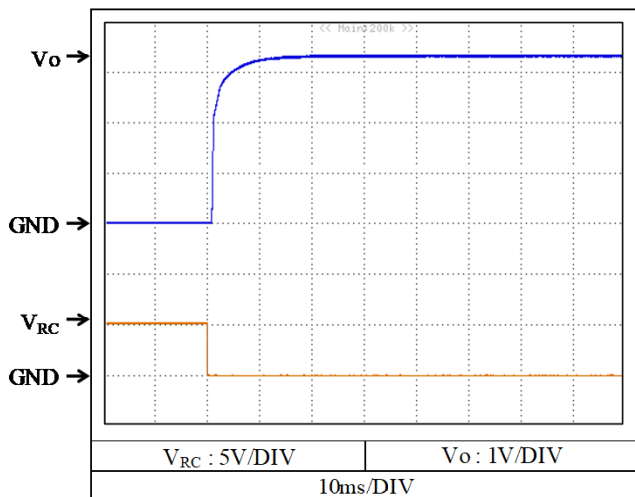

5V

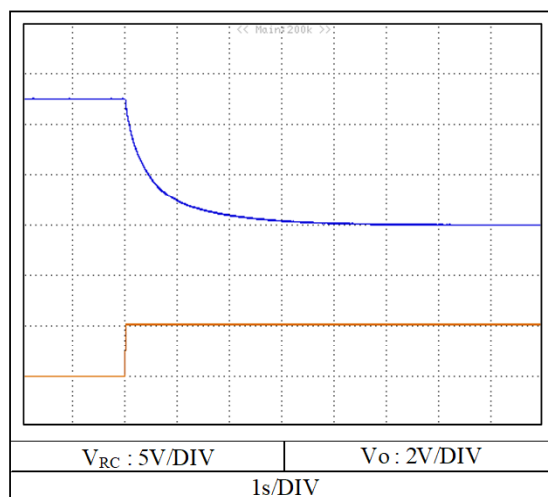
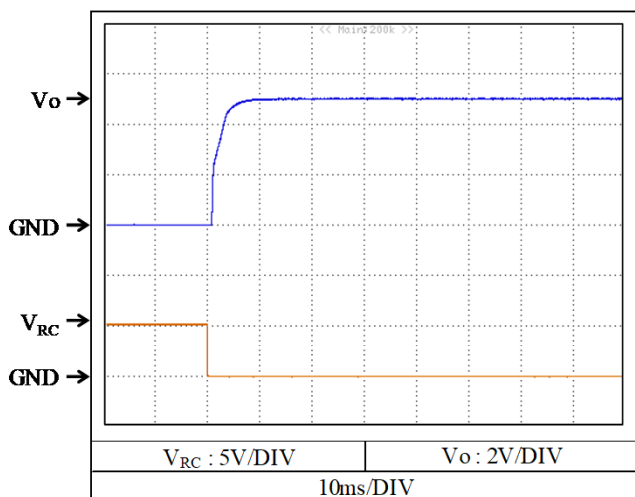

2-5. 出力立ち上がり・立ち下がり特性 (リモートON/OFFコントロール時)

Output rise and fall characteristics with REMOTE ON/OFF CONTROL

Conditions V_{in} : 48 VDC
 I_o : 0 %
 T_a : 25 °C

12V

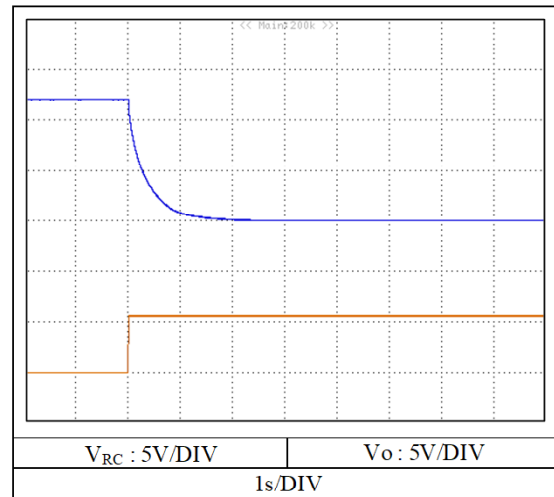
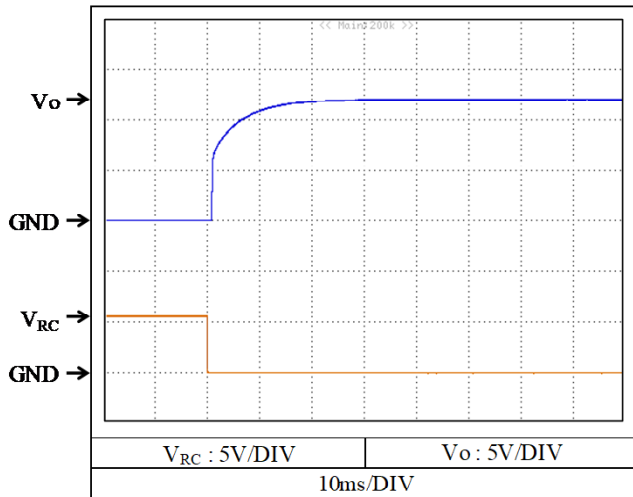

15V

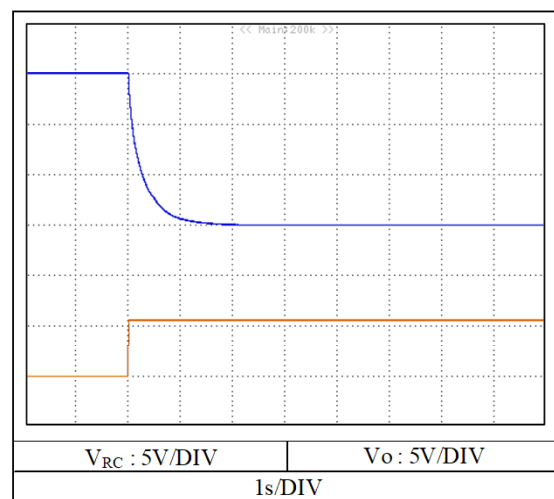
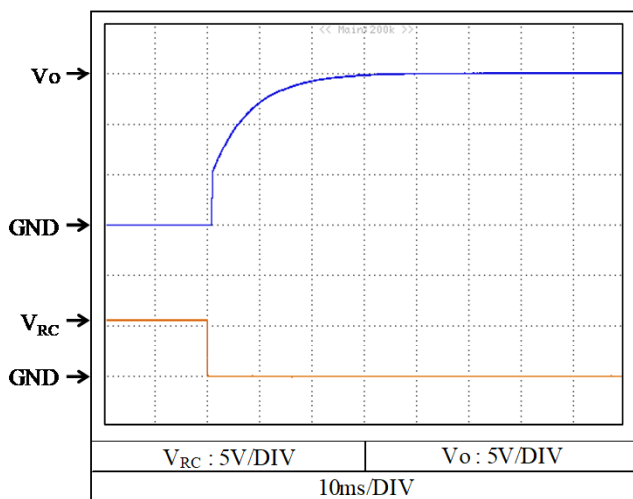

2-5. 出力立ち上がり・立ち下がり特性 (リモートON/OFFコントロール時)

Output rise and fall characteristics with REMOTE ON/OFF CONTROL

Conditions V_{in} : 48 VDC
 I_o : 100 %
 T_a : 25 °C

3.3V

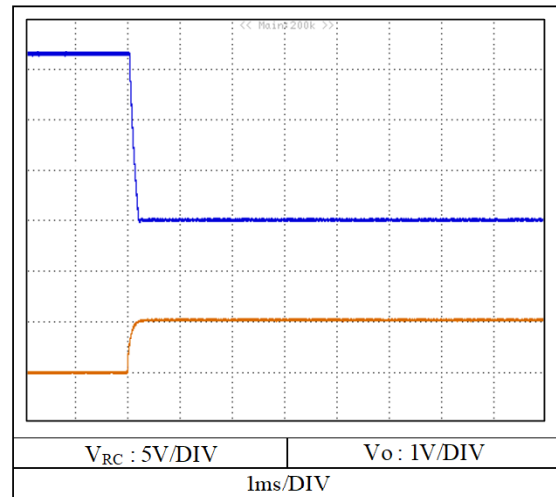
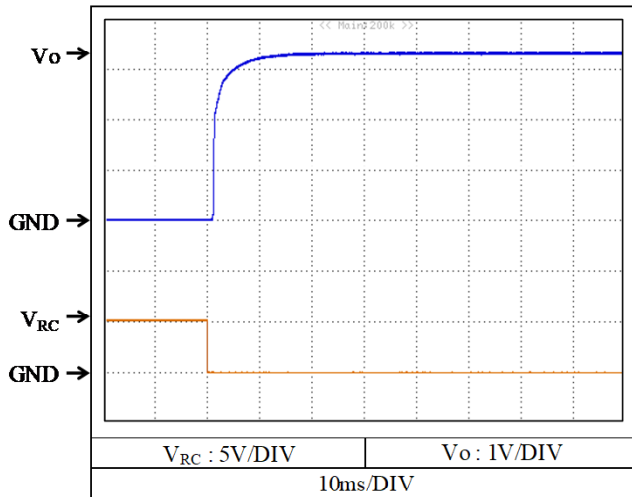

5V

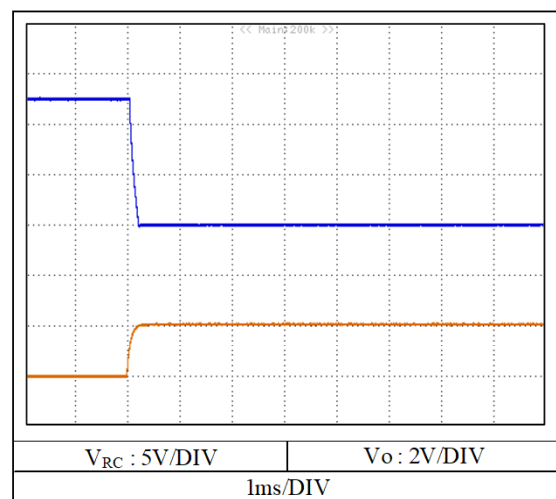
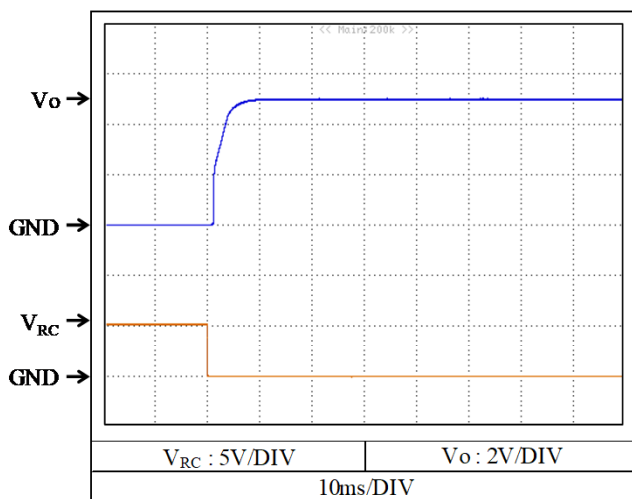

2-5. 出力立ち上がり・立ち下がり特性 (リモートON/OFFコントロール時)

Output rise and fall characteristics with REMOTE ON/OFF CONTROL

Conditions V_{in} : 48 VDC
 I_o : 100 %
 T_a : 25 °C

12V

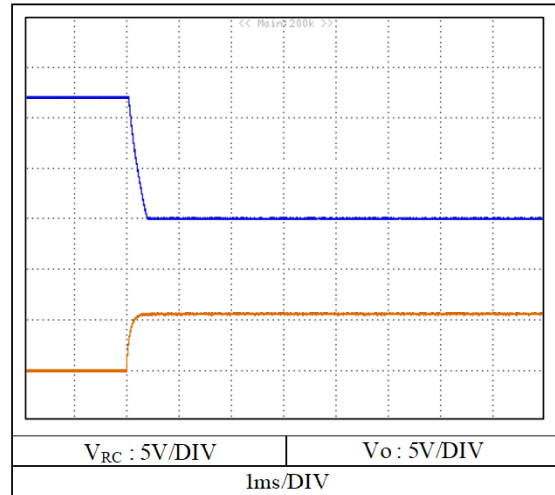
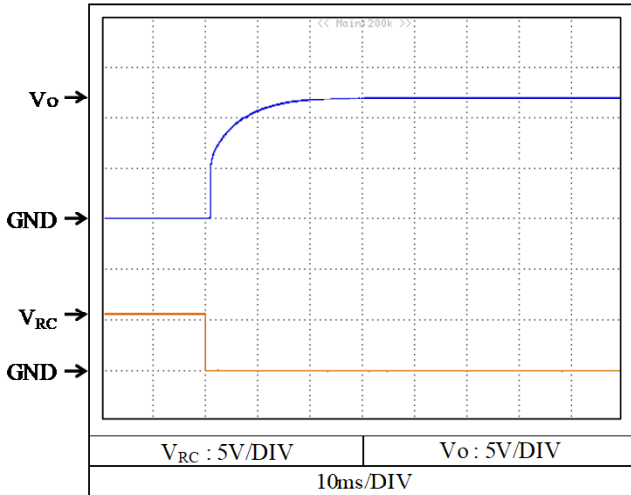

15V

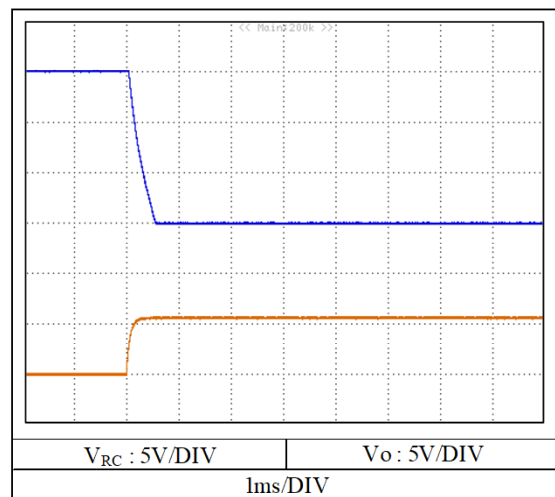
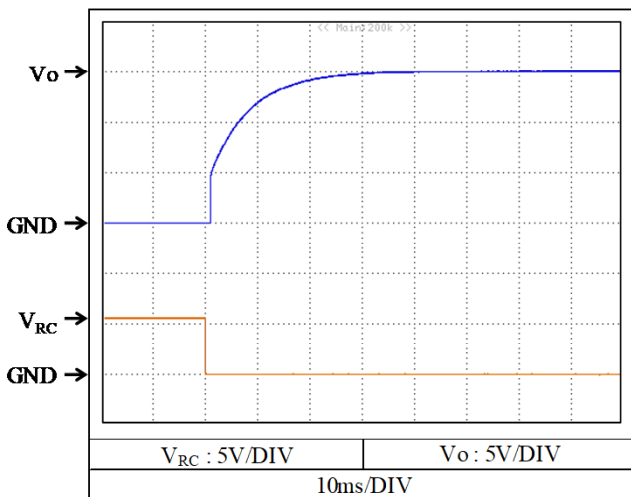

2-6. 過渡応答(負荷急変)特性 Dynamic load response characteristics

Conditions V_{in} : 48 VDC
 T_a : 25 °C

3.3V

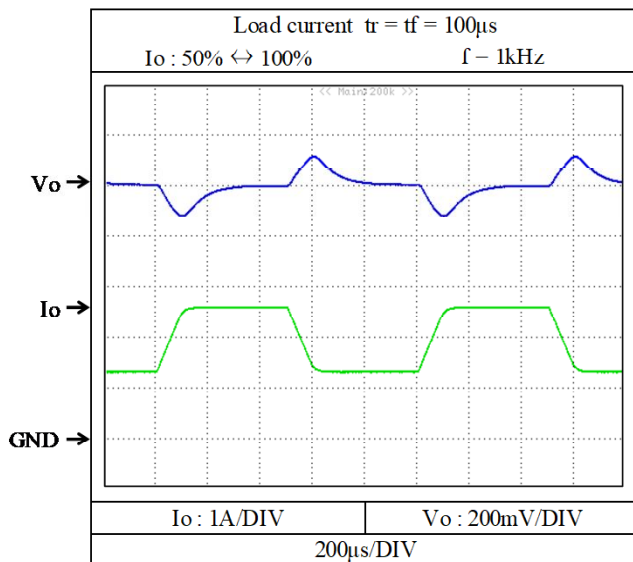

5V

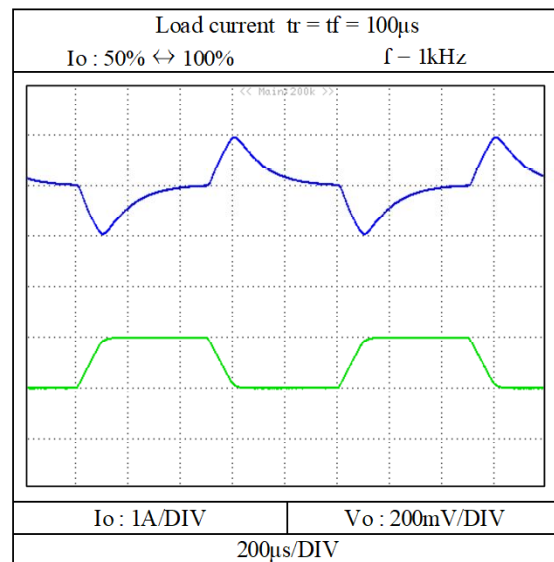

12V

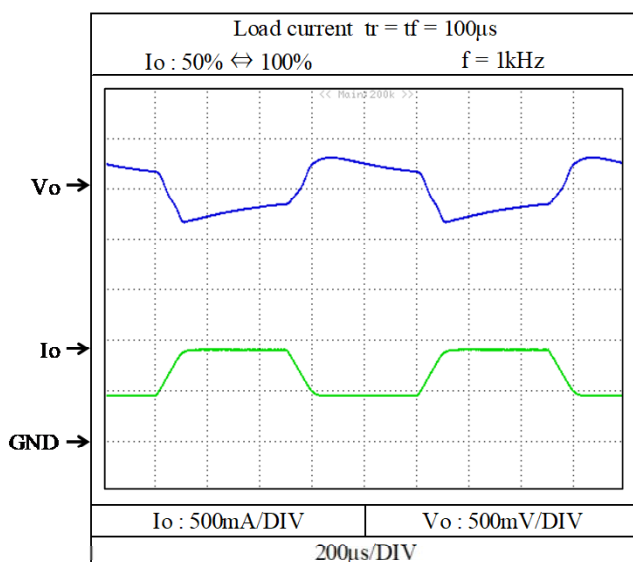

15V

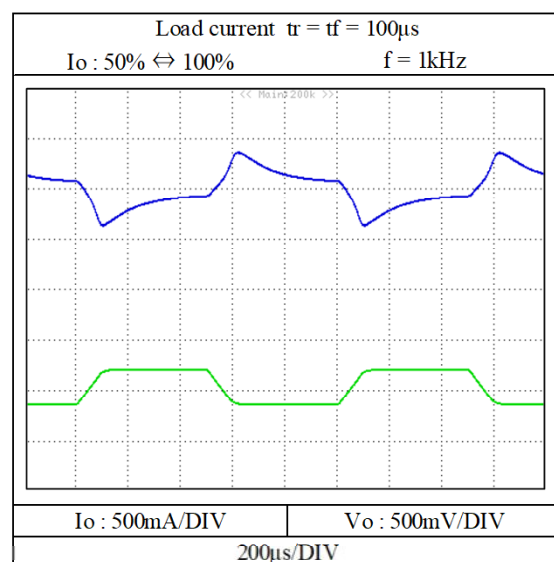

2-7. 入力サージ電流(突入電流)特性 Inrush current characteristics

Conditions V_{in} : 48 VDC
 I_o : 100 %
 T_a : 25 °C

CCG10-48-05S

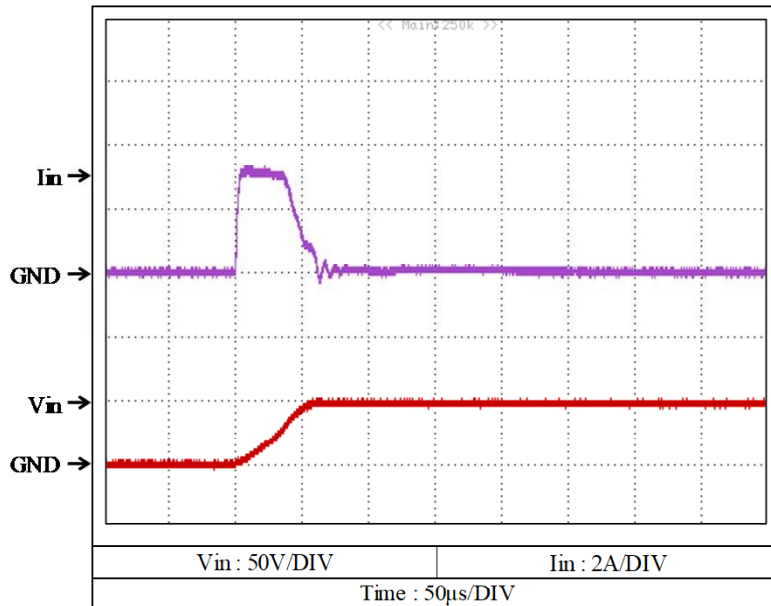

CCG10-48-xxSの入力サージ電流特性は CCG10-48-05S と同等です。
 CCG10-48-xxS have the same Inrush current characteristics as CCG10-48-05S data.

2-8. 出力リップルノイズ波形 Output ripple and noise waveform

Conditions V_{in} : 48 VDC
 I_o : 100 %
 T_a : 25 °C

3.3V

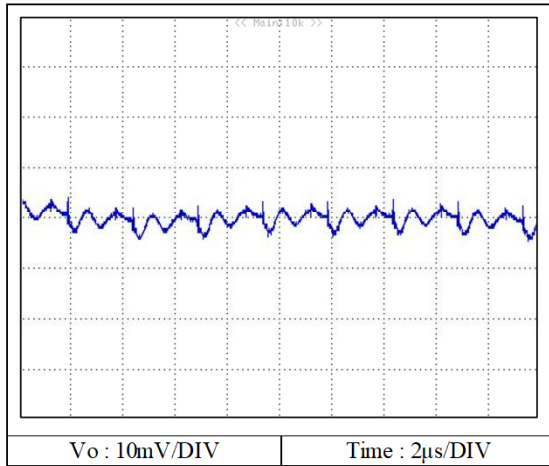

5V

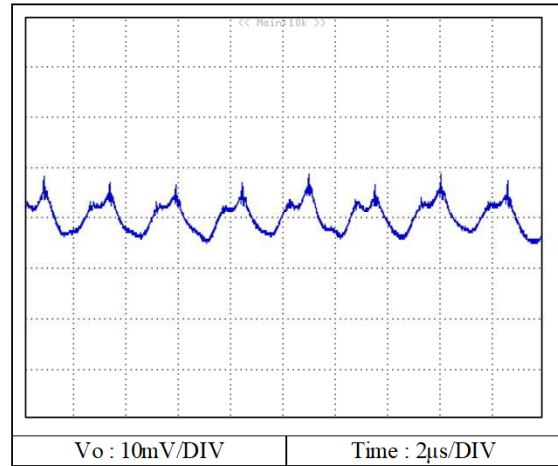

12V

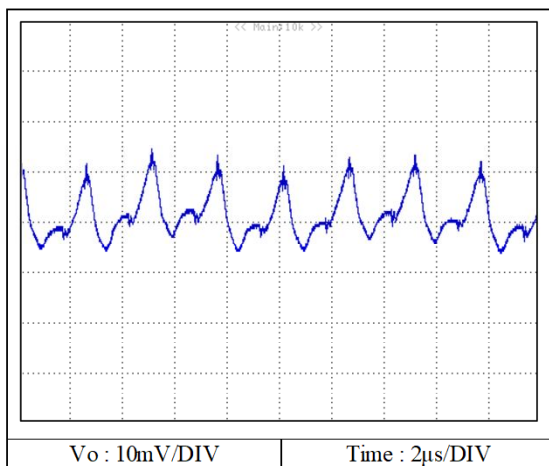

15V

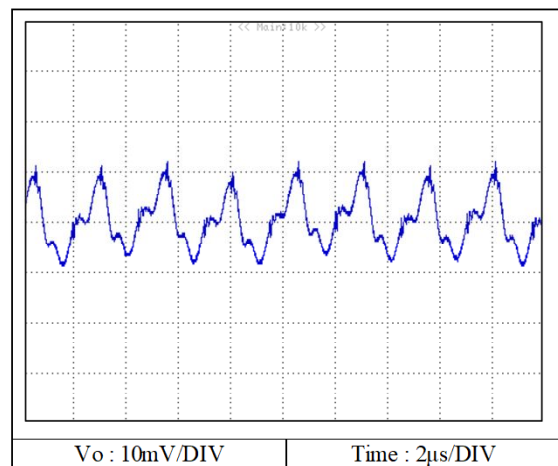

2-9. EMI特性 Electro-Magnetic Interference characteristics

(a) 雑音端子電圧 (帰還ノイズ) Conducted Emission Noise

Conditions Vin : 48 VDC
 Io : 100 %
 Ta : 25 °C

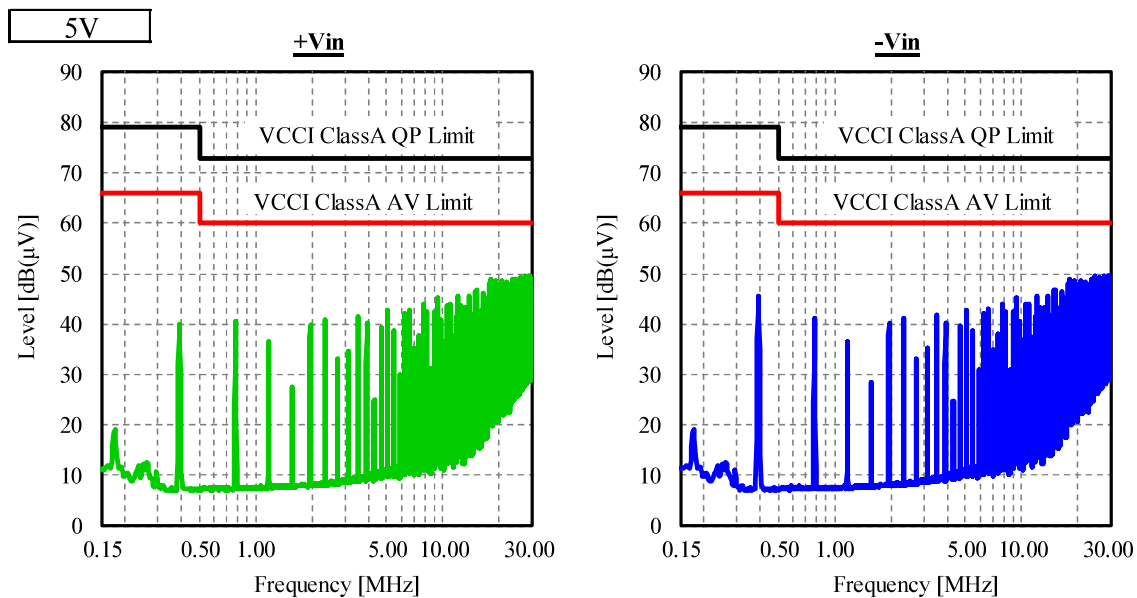
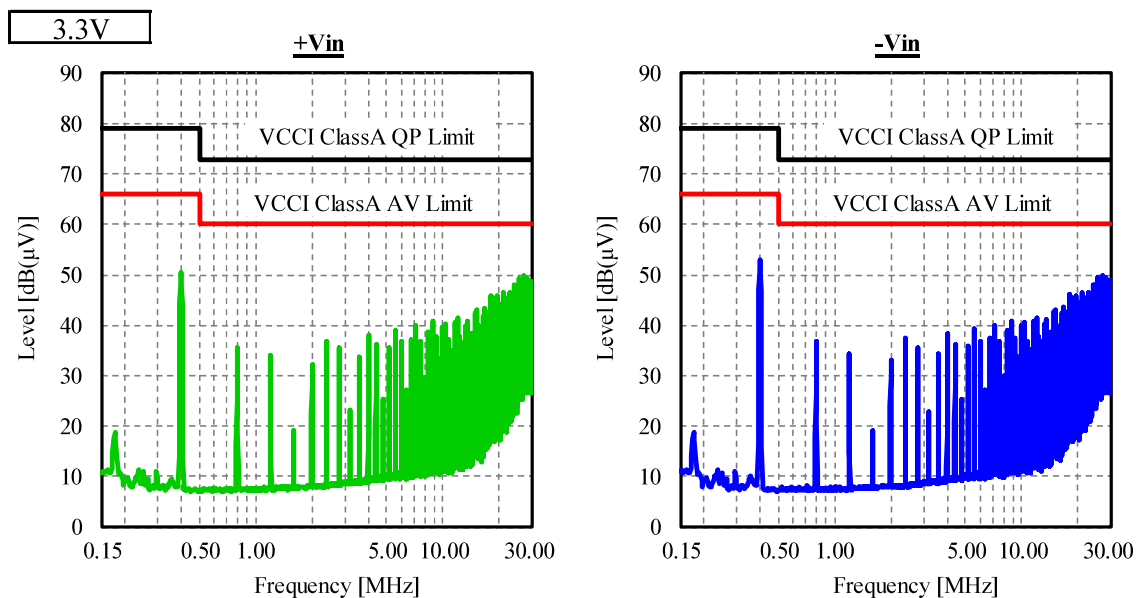

表示はQP値
 Indication is QP values.

2-9. EMI特性 Electro-Magnetic Interference characteristics

(a) 雑音端子電圧 (帰還ノイズ) Conducted Emission Noise

Conditions Vin : 48 VDC
 Io : 100 %
 Ta : 25 °C

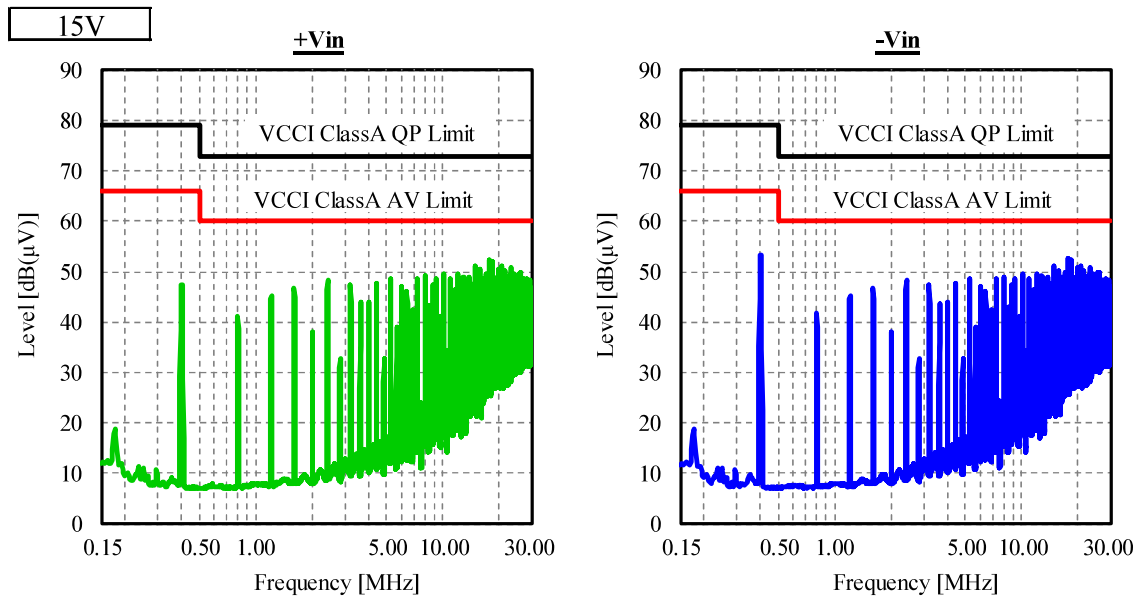
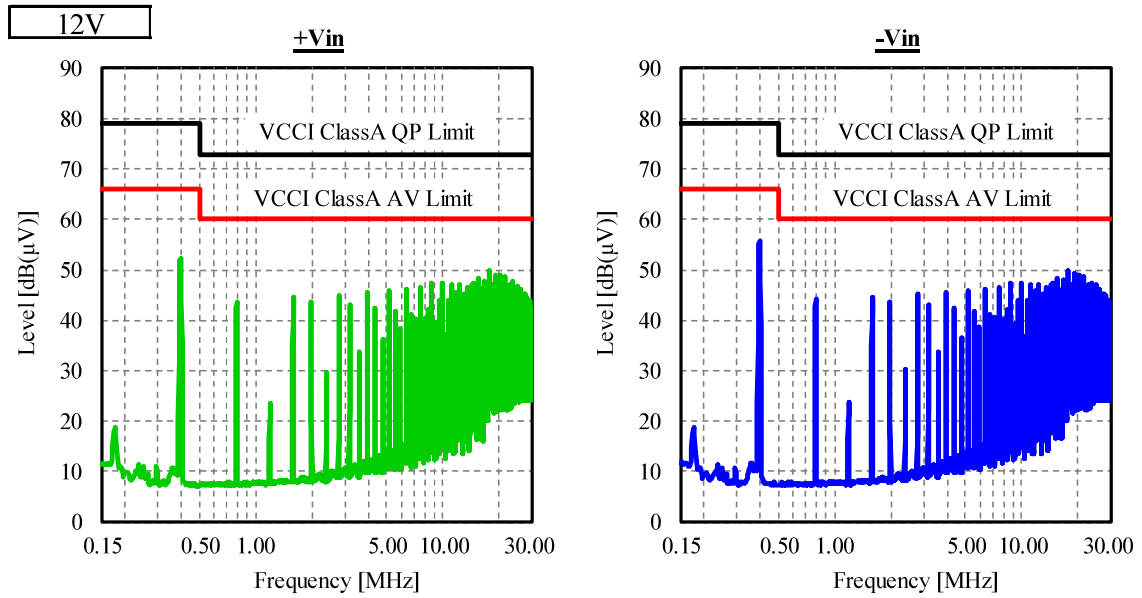

表示はQP値
 Indication is QP values.

2-9. EMI特性 Electro-Magnetic Interference characteristics
 (b) 雑音電界強度 (輻射ノイズ) Radiated Emission Noise

Conditions Vin : 48 VDC
 Io : 100 %
 Ta : 25 °C

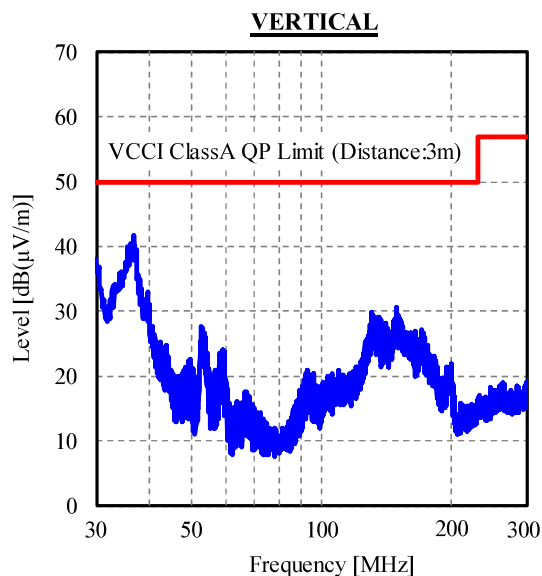
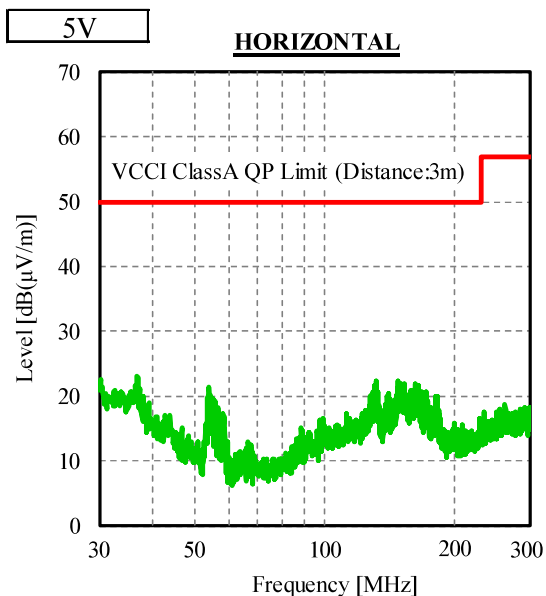
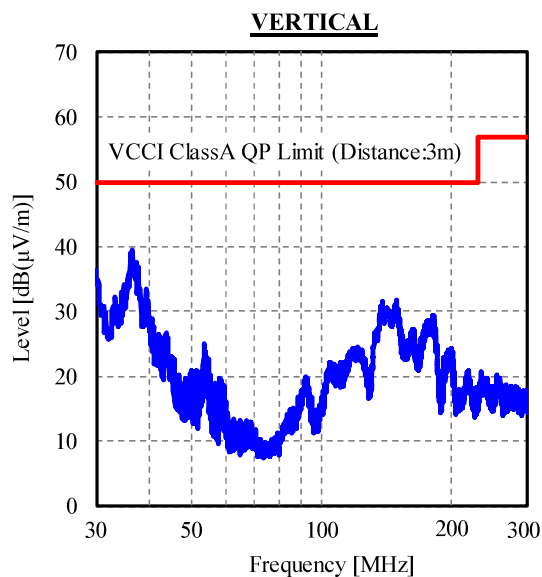
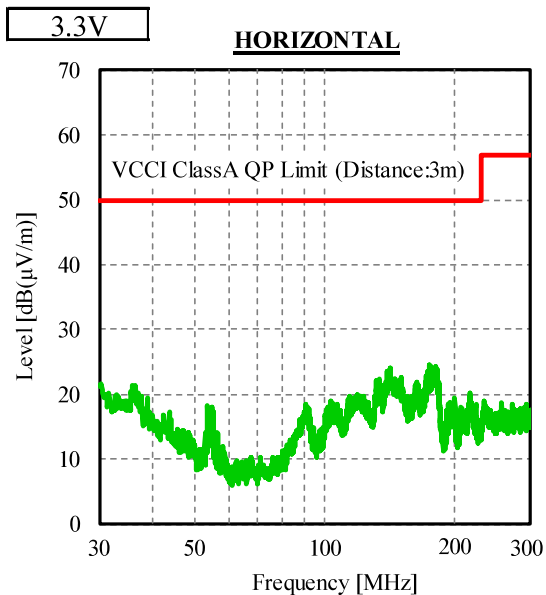

表示はピーク値
 Indication is peak values.

2-9. EMI特性 Electro-Magnetic Interference characteristics
 (b) 雑音電界強度 (輻射ノイズ) Radiated Emission Noise

Conditions Vin : 48 VDC
 Io : 100 %
 Ta : 25 °C

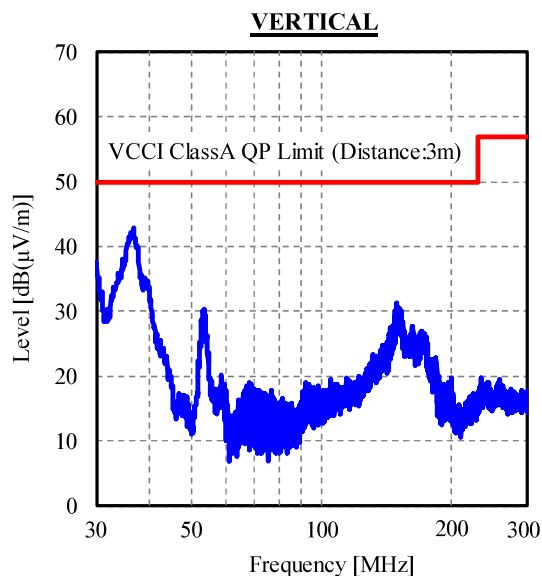
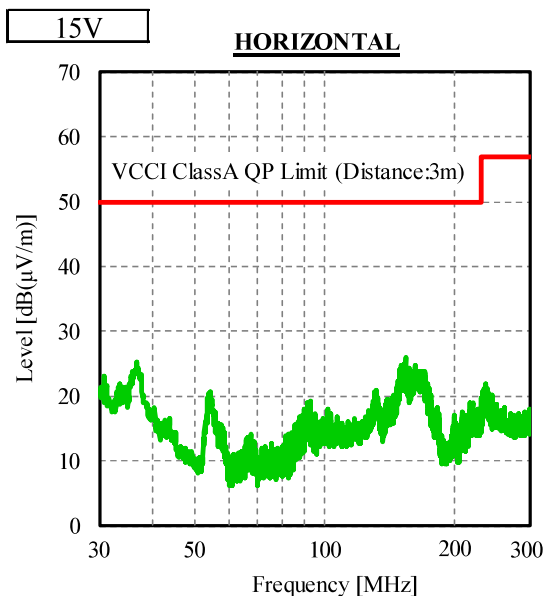
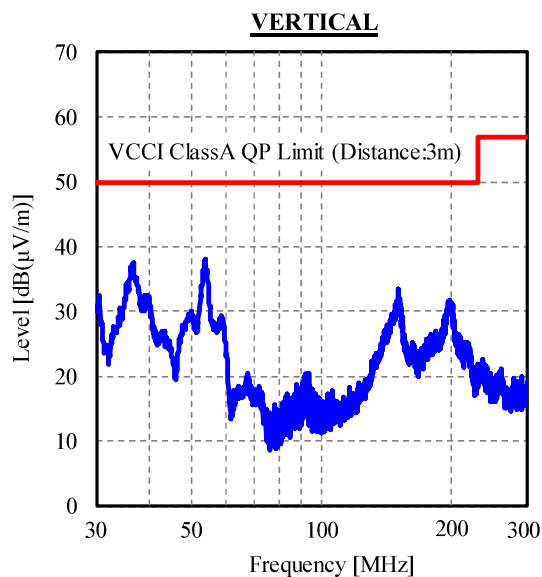
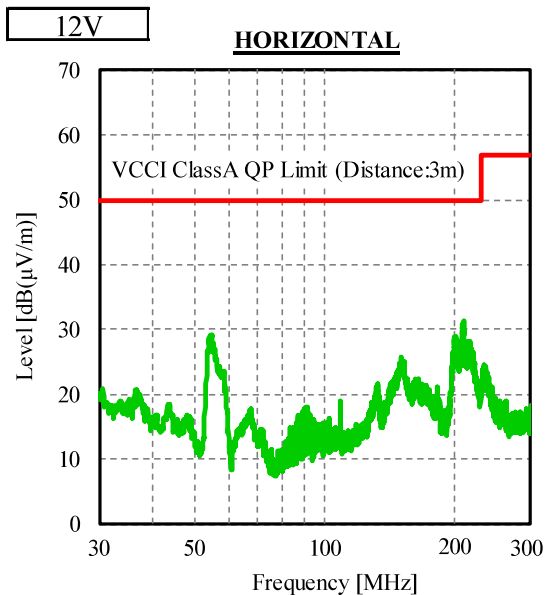

表示はピーク値
 Indication is peak values.