

CCG1R5-48-xxS

EVALUATION DATA

型式データ

INDEX

	PAGE
1. 測定方法 Evaluation Method	
1-1. 測定回路 Measurement Circuits	3
(1) 静特性、待機電力特性、通電ドリフト特性、その他特性 Steady state, Standby power, Warm up voltage drift and Other characteristics	
(2) 入力サージ電流(突入電流)波形 Inrush current waveform	
(3) 出力リップルノイズ電圧、波形 Output ripple and noise voltage and waveform	
(4) EMI特性 Electro-Magnetic Interference characteristics	
1-2. 使用測定機器 List of equipment used	5
2. 特性データ Characteristics	
2-1. 静特性 Steady state characteristics	
(1) 入力・負荷・温度変動 Regulation - line and load, Temperature drift	6
(2) 出力電圧・出力リップルノイズ電圧 対 入力電圧 Output voltage and Output ripple and noise voltage vs. Input voltage	7
(3) 入力電流・効率 対 出力電流 Input current and Efficiency vs. Output current	9
(4) 効率 対 入力電圧 Efficiency vs. Input voltage	11
(5) 起動・遮断電圧特性 Start up and Drop out voltage characteristics	13
2-2. 待機電力特性 Standby power characteristics	15
2-3. 通電ドリフト特性 Warm up voltage drift characteristics	17
2-4. 過電流保護特性 Over current protection (OCP) characteristics	19
2-5. 出力立ち上がり・立ち下がり特性 Output rise and fall characteristics	21
2-6. 過渡応答(負荷急変)特性 Dynamic load response characteristics	29
2-7. 入力サージ電流(突入電流)特性 Inrush current characteristics	30
2-8. 出力リップルノイズ波形 Output ripple and noise waveform	31
2-9. EMI特性 Electro-Magnetic Interference characteristics	32

使用記号 Terminology used

	定義	Definition
V_{in} 入力電圧	Input voltage
V_o 出力電圧	Output voltage
V_{RC} RC電圧	RC voltage
I_{in} 入力電流	Input current
I_o 出力電流	Output current
T_a 周囲温度	Ambient temperature
f 周波数	Frequency

※ 当社測定条件における結果であり、参考値としてお考え願います。
Test results are reference data based on our measurement condition.

1. 測定方法 Evaluation Method

1-1. 測定回路 Measurement Circuits

(1) 静特性、待機電力特性、通電ドリフト特性、その他特性

Steady state, Standby power, Warm up voltage drift and Other characteristics

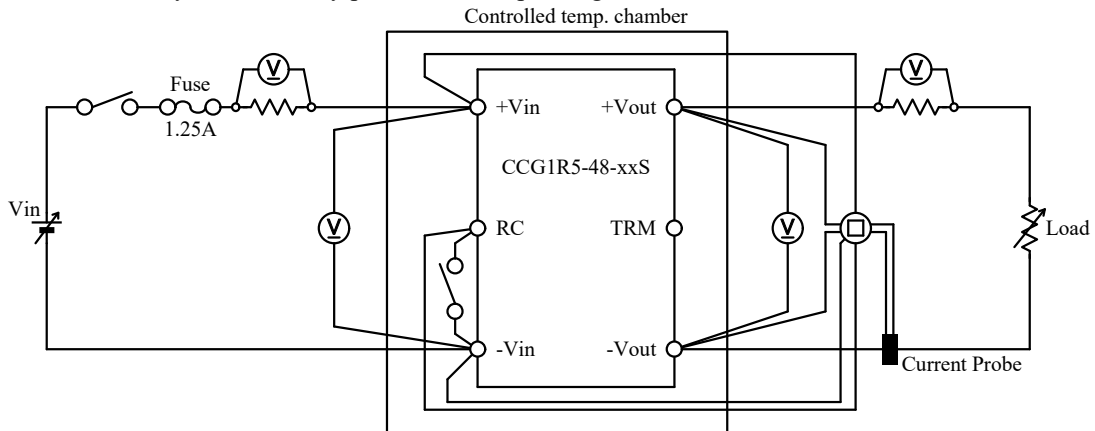

(2) 入力サージ電流(突入電流)波形 Inrush current waveform

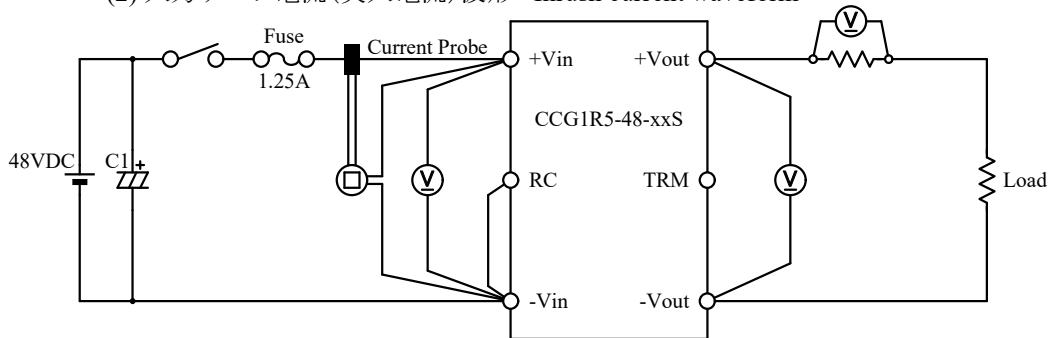

(3) 出力リップルノイズ電圧、波形 Output ripple and noise voltage and waveform

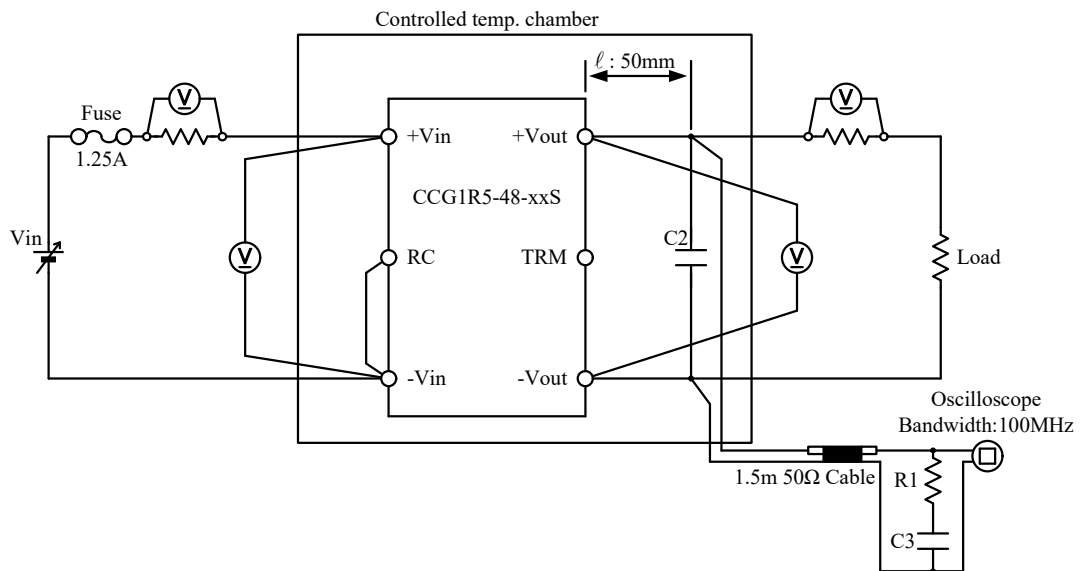

- | | |
|-------------------|------------------------|
| C1 : 4000 μ F | Electrolytic Capacitor |
| C2 : 1 μ F | Ceramic Capacitor |
| C3 : 4700pF | Ceramic Capacitor |
| R1 : 50 Ω | |

(4) EMI特性 Electro-Magnetic Interference characteristics

(a) 雑音端子電圧(帰還ノイズ) Conducted Emission Noise

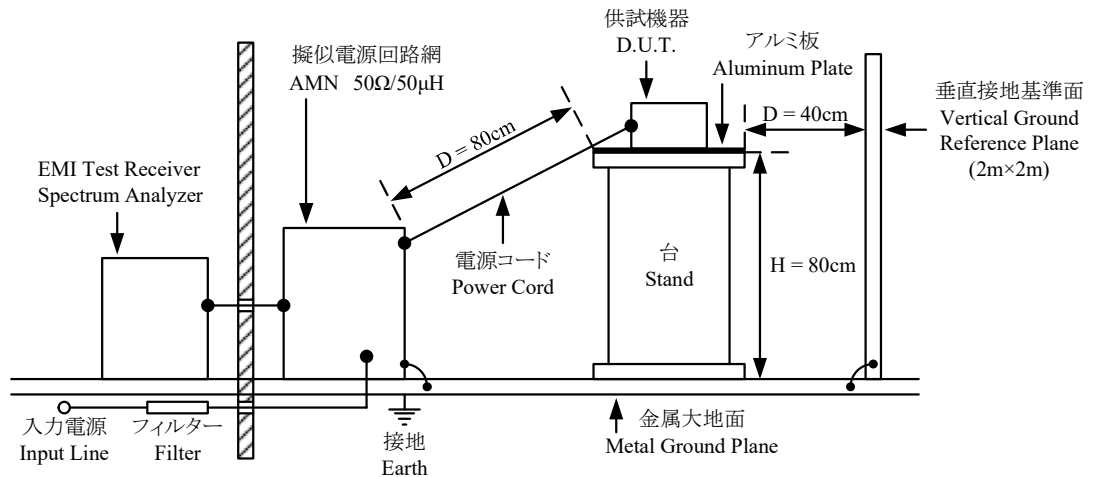

(b) 雑音電界強度(輻射ノイズ) Radiated Emission Noise

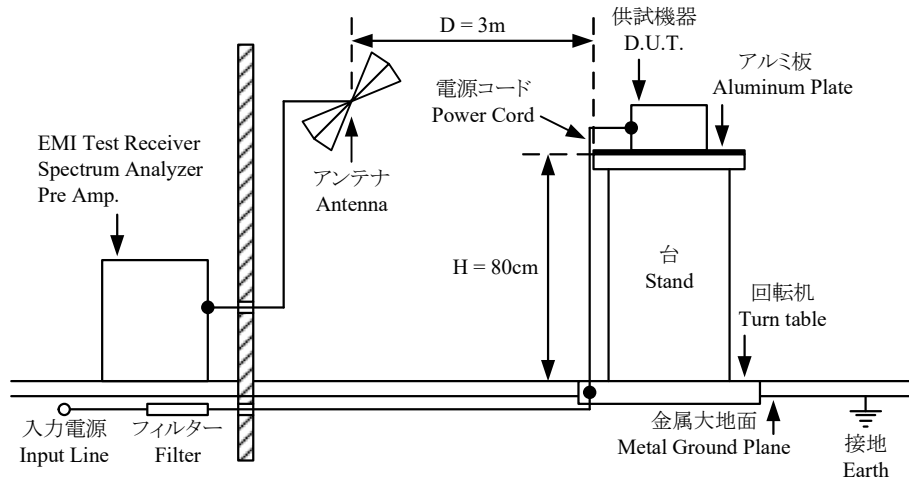

VCCI class A 対応アプリケーション VCCI class A application system

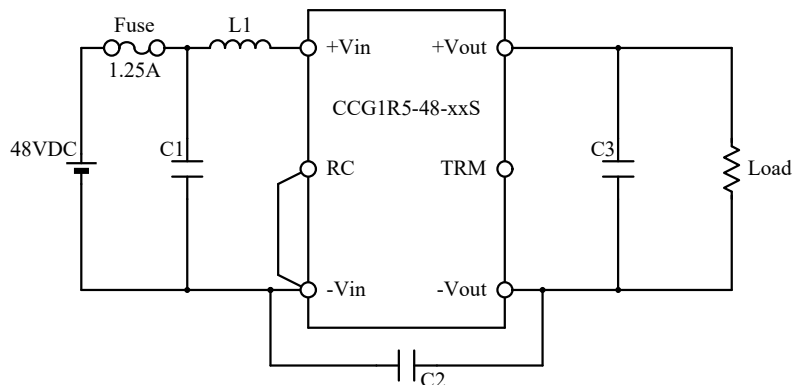

- | | | |
|-----------------|------------------------|-------------------------|
| C1 : 100V 2.2μF | Ceramic Capacitor | (C3216X7S2A225K, TDK) |
| C2 : 2kV 1000pF | Ceramic Capacitor | (C4520X7R3D102K, TDK) |
| C3 : 25V 10μF | Ceramic Capacitor | (C3216X7R1E106K, TDK) |
| L1 : 22μH 650mA | Normal Mode Choke Coil | (LQH32PB220MNC, MURATA) |

1-2. 使用測定機器 List of equipment used

	EQUIPMENT USED	MANUFACTURER	MODEL NO.
1	DIGITAL STORAGE OSCILLOSCOPE	YOKOGAWA ELECT.	DL1740E / DL1740EL
2	DIGITAL MULTIMETER	AGILENT	34970A
3	CURRENT PROBE	YOKOGAWA ELECT.	701932
4	CURRENT PROBE	AGILENT	N2774A
5	SHUNT RESISTER	YOKOGAWA ELECT.	2215
6	DYNAMIC DUMMY LOAD	KIKUSUI	PLZ-164WL
7	CVCF	NF	ES10000S
8	DC POWER SUPPLY	TDK-Lambda	GEN80-9.5 / GENH80-9.5
9	DC POWER SUPPLY	TAKASAGO	EX-750H2
10	CONTROLLED TEMP. CHAMBER	ESPEC	SU-261 / SU-262
11	EMI TEST RECEIVER / SPECTRUM ANALYZER	ROHDE & SCHWARZ	ESR3
12	PRE AMP.	SONOMA	310N
13	AMN	KIKUSUI	KNW-242C
14	ANTENNA	SCHWARZBECK	BBA9106/VHA9103
15	ANTENNA	SCHWARZBECK	UHALP9107

2. 特性データ Characteristics

2-1. 静特性 Steady state characteristics

(1) 入力・負荷・温度変動 Regulation - line and load, Temperature drift

3.3V

1. Regulation - line and load

Condition Ta : 25 °C

Io \ Vin	18VDC	24VDC	48VDC	76VDC	Line regulation	
0%	3.2985V	3.2986V	3.2986V	3.2986V	0.1mV	0.003%
50% (0.2A)	3.2983V	3.2983V	3.2984V	3.2984V	0.1mV	0.003%
100% (0.4A)	3.2981V	3.2982V	3.2982V	3.2982V	0.1mV	0.003%
Load regulation	0.4mV	0.4mV	0.4mV	0.4mV		
	0.012%	0.012%	0.012%	0.012%		

2. Temperature drift

Conditions Vin : 48 VDC

Io : 100 %

Ta	-40°C	25°C	85°C	Temperature stability	
Vo	3.3004V	3.2982V	3.2956V	4.8mV	0.145%

5V

1. Regulation - line and load

Condition Ta : 25 °C

Io \ Vin	18VDC	24VDC	48VDC	76VDC	Line regulation	
0%	5.0162V	5.0163V	5.0164V	5.0164V	0.2mV	0.004%
50% (0.15A)	5.0161V	5.0162V	5.0164V	5.0165V	0.4mV	0.008%
100% (0.3A)	5.0163V	5.0164V	5.0165V	5.0167V	0.4mV	0.008%
Load regulation	0.2mV	0.2mV	0.1mV	0.3mV		
	0.004%	0.004%	0.002%	0.006%		

2. Temperature drift

Conditions Vin : 48 VDC

Io : 100 %

Ta	-40°C	25°C	85°C	Temperature stability	
Vo	5.0062V	5.0165V	5.0266V	20.4mV	0.408%

12V

1. Regulation - line and load

Condition Ta : 25 °C

Io \ Vin	18VDC	24VDC	48VDC	76VDC	Line regulation	
0%	12.0579V	12.0579V	12.0581V	12.0579V	0.2mV	0.002%
50% (0.065A)	12.0570V	12.0574V	12.0577V	12.0574V	0.7mV	0.006%
100% (0.13A)	12.0571V	12.0573V	12.0574V	12.0574V	0.3mV	0.002%
Load regulation	0.9mV	0.6mV	0.7mV	0.5mV		
	0.007%	0.005%	0.006%	0.004%		

2. Temperature drift

Conditions Vin : 48 VDC

Io : 100 %

Ta	-40°C	25°C	85°C	Temperature stability	
Vo	12.0720V	12.0574V	12.0466V	25.4mV	0.212%

15V

1. Regulation - line and load

Condition Ta : 25 °C

Io \ Vin	18VDC	24VDC	48VDC	76VDC	Line regulation	
0%	15.1673V	15.1671V	15.1674V	15.1668V	0.6mV	0.004%
50% (0.05A)	15.1661V	15.1663V	15.1667V	15.1666V	0.6mV	0.004%
100% (0.1A)	15.1659V	15.1663V	15.1663V	15.1664V	0.5mV	0.003%
Load regulation	1.4mV	0.8mV	1.1mV	0.4mV		
	0.009%	0.005%	0.007%	0.003%		

2. Temperature drift

Conditions Vin : 48 VDC

Io : 100 %

Ta	-40°C	25°C	85°C	Temperature stability	
Vo	15.1785V	15.1663V	15.1358V	42.7mV	0.285%

(2) 出力電圧・出力リップルノイズ電圧 対 入力電圧

Output voltage and Output ripple and noise voltage vs. Input voltage

Conditions I_o : 100 %
 T_a : -40 °C
 : 25 °C
 : 85 °C

3.3V

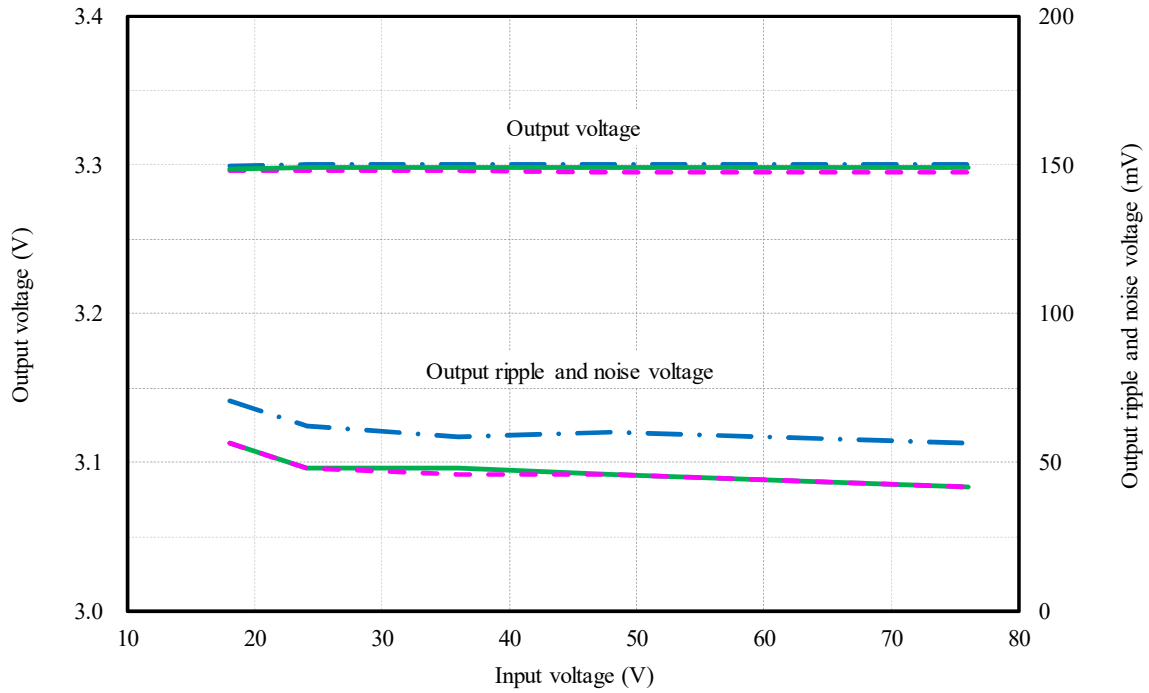

5V

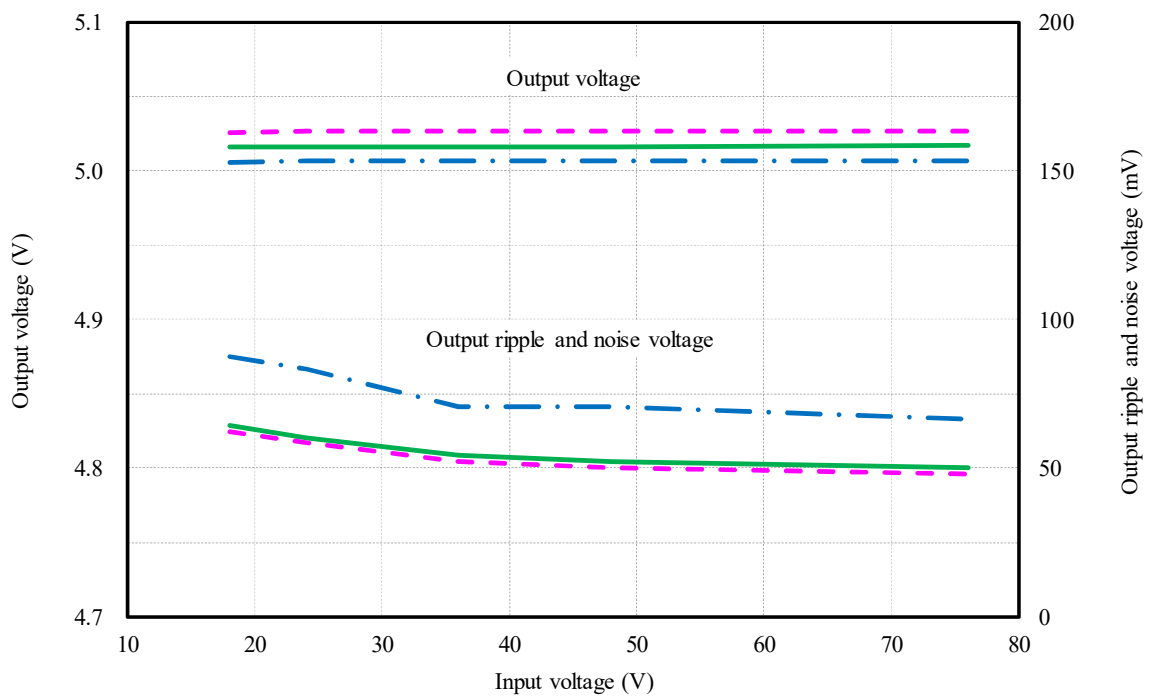

(2) 出力電圧・出力リップルノイズ電圧 対 入力電圧

Output voltage and Output ripple and noise voltage vs. Input voltage

Conditions Io : 100 %
 Ta : -40 °C
 : 25 °C
 : 85 °C

12V

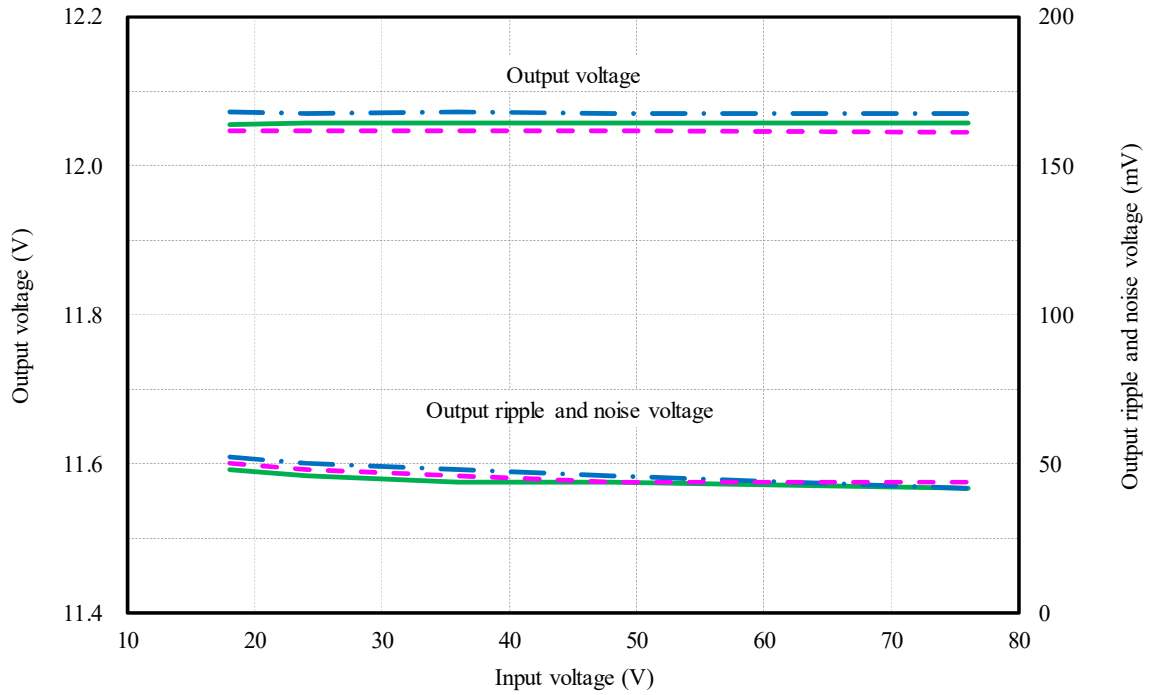

15V

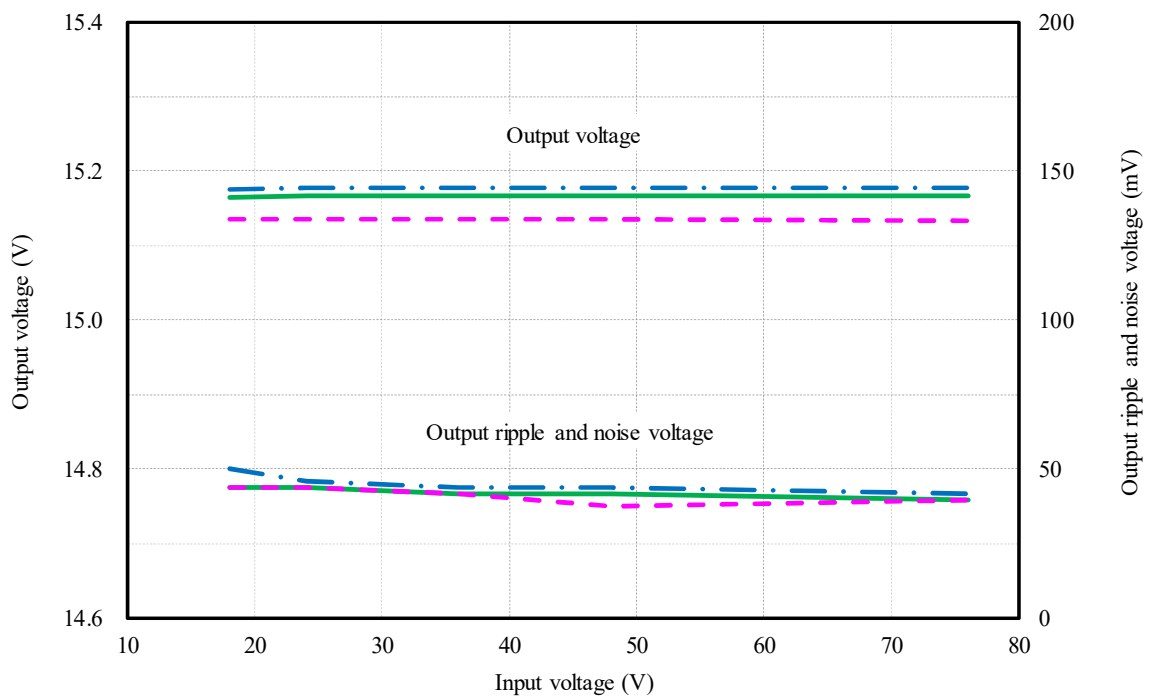

(3) 入力電流・効率 対 出力電流 Input current and Efficiency vs. Output current

Conditions Vin : 18 VDC ——— (Yellow dashed)
 : 24 VDC - · - · (Blue dash-dot)
 : 48 VDC ——— (Green solid)
 : 76 VDC - · - · (Magenta dash-dot)
 Ta : 25 °C

3.3V

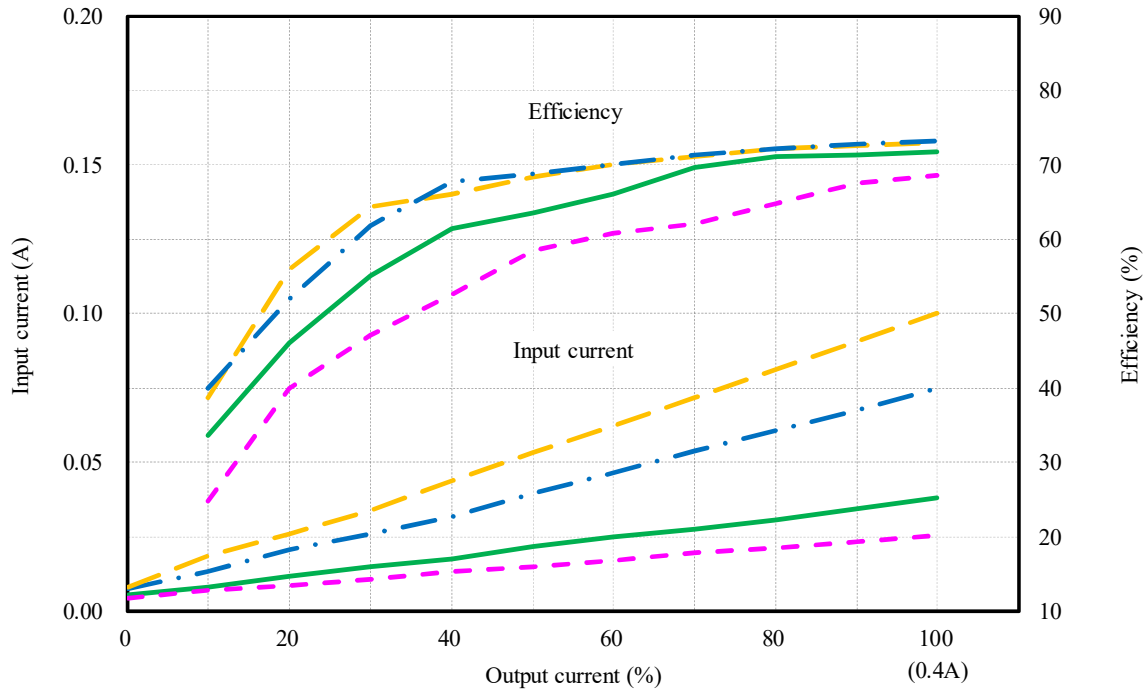

5V

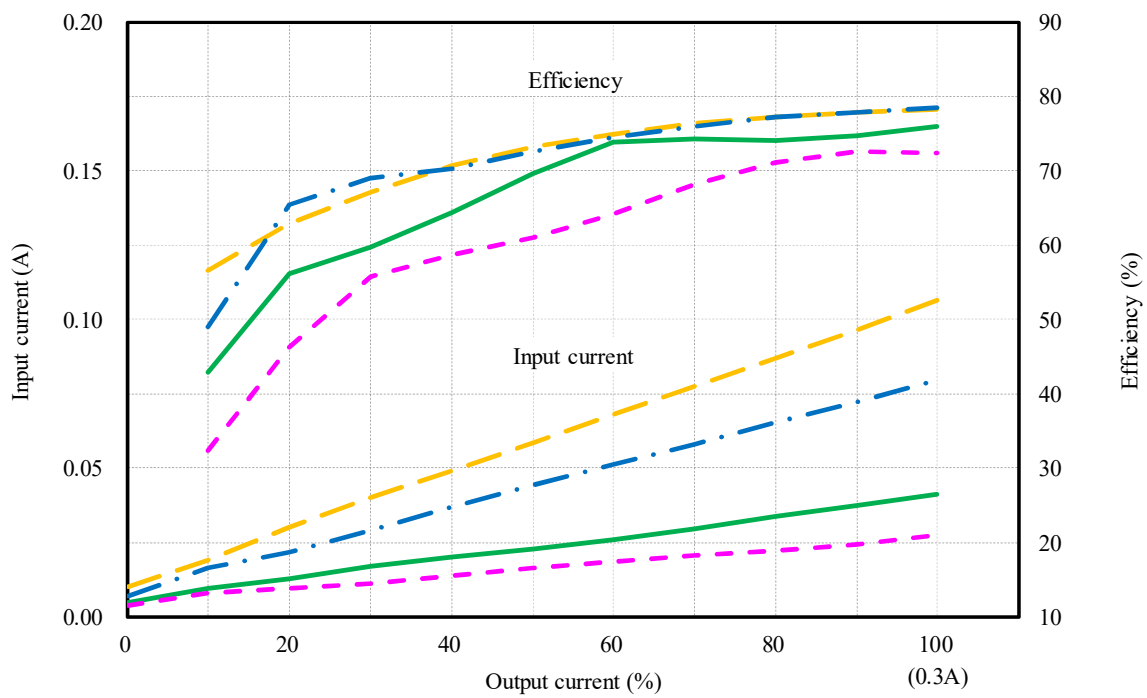

(3) 入力電流・効率 対 出力電流 Input current and Efficiency vs. Output current

Conditions Vin : 18 VDC ————
 : 24 VDC - · - · -
 : 48 VDC ————
 : 76 VDC - - - -
 Ta : 25 °C

12V

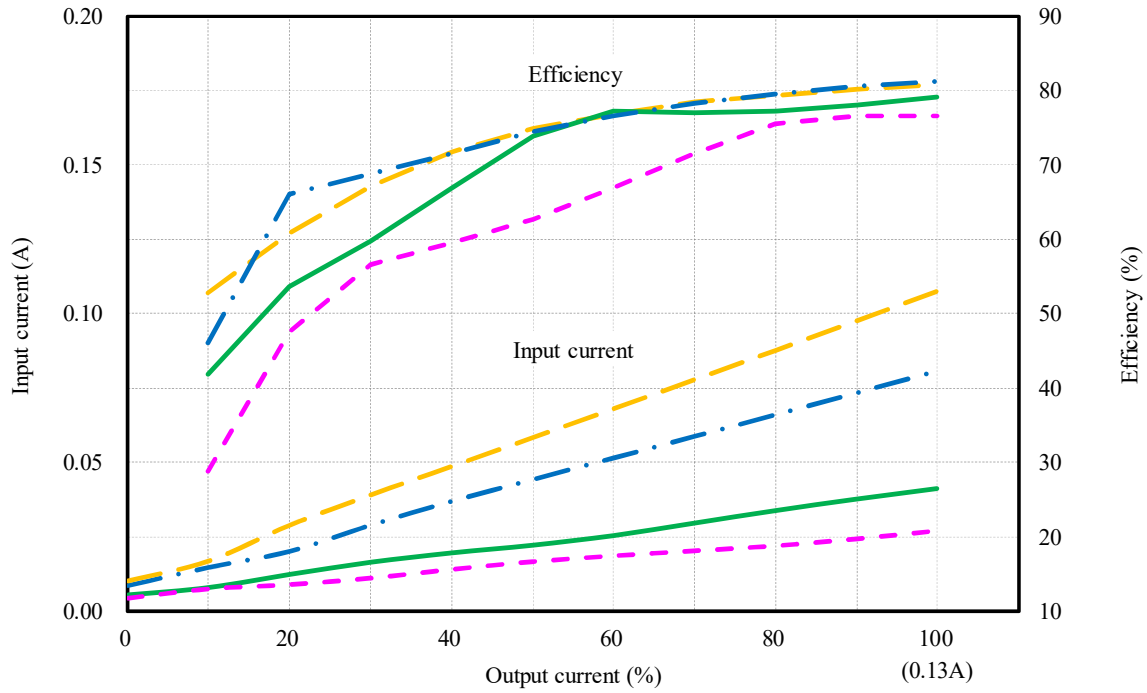

15V

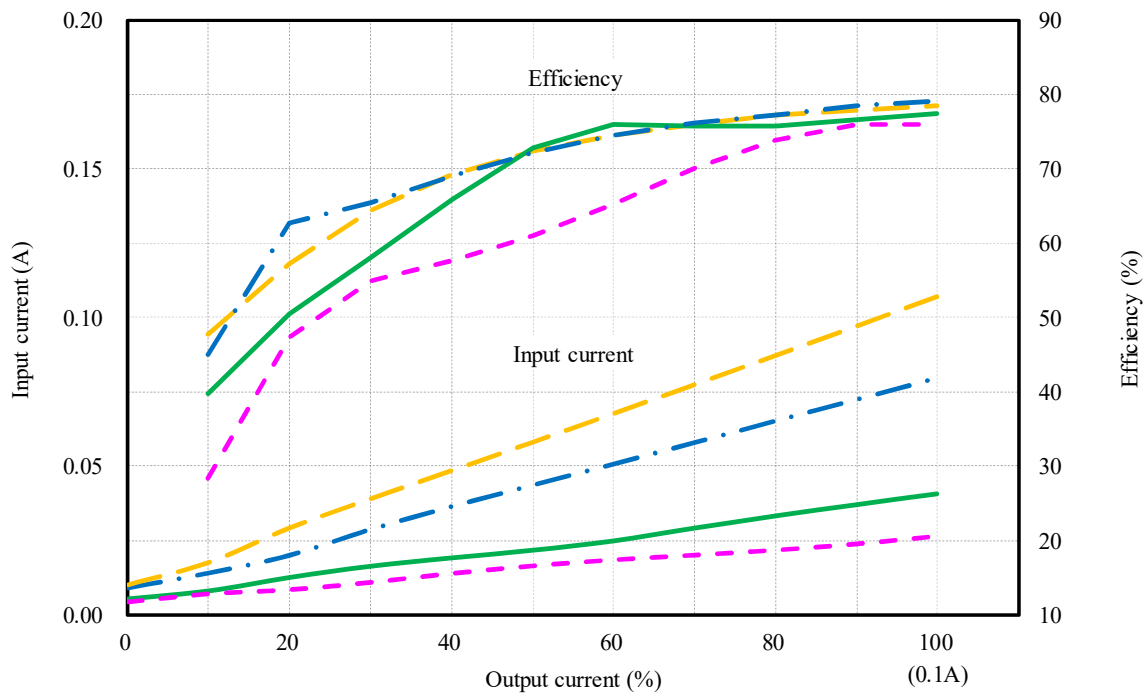

(4) 効率 対 入力電圧 Efficiency vs. Input voltage

Conditions Io : 50 % ---
 : 100 % —
 Ta : 25 °C

3.3V

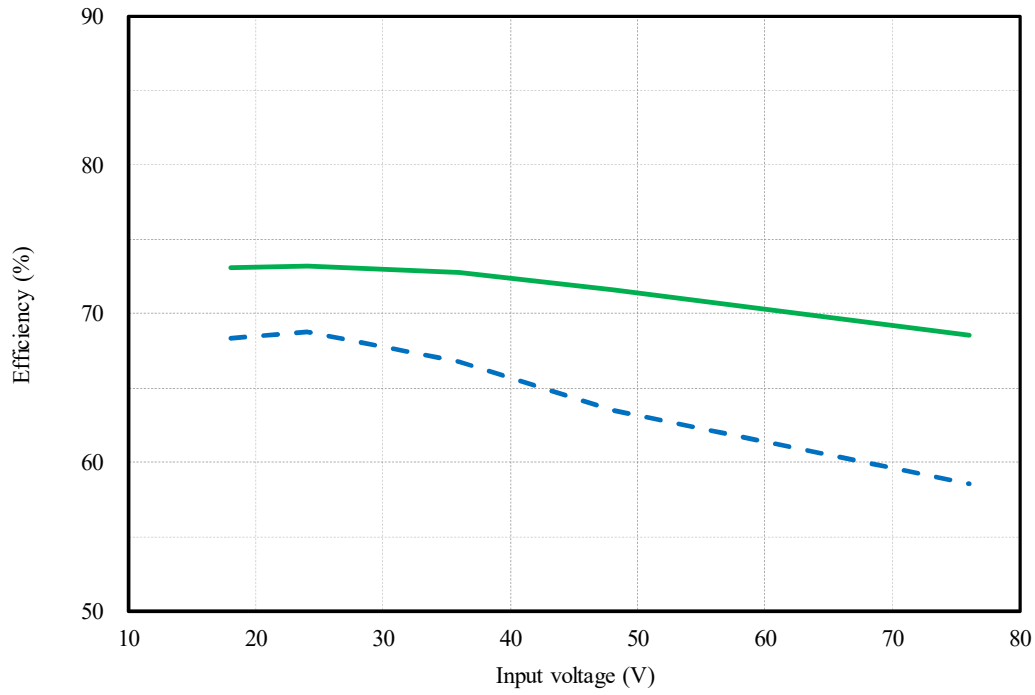

5V

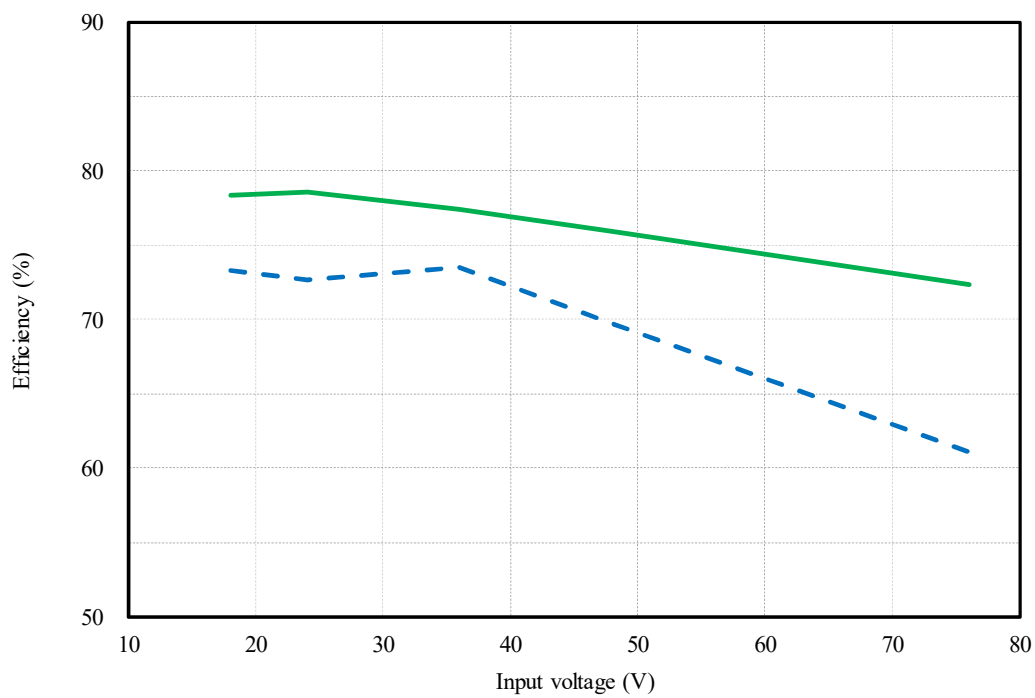

(4) 効率 対 入力電圧 Efficiency vs. Input voltage

Conditions Io : 50 % ---
 : 100 % —
 Ta : 25 °C

12V

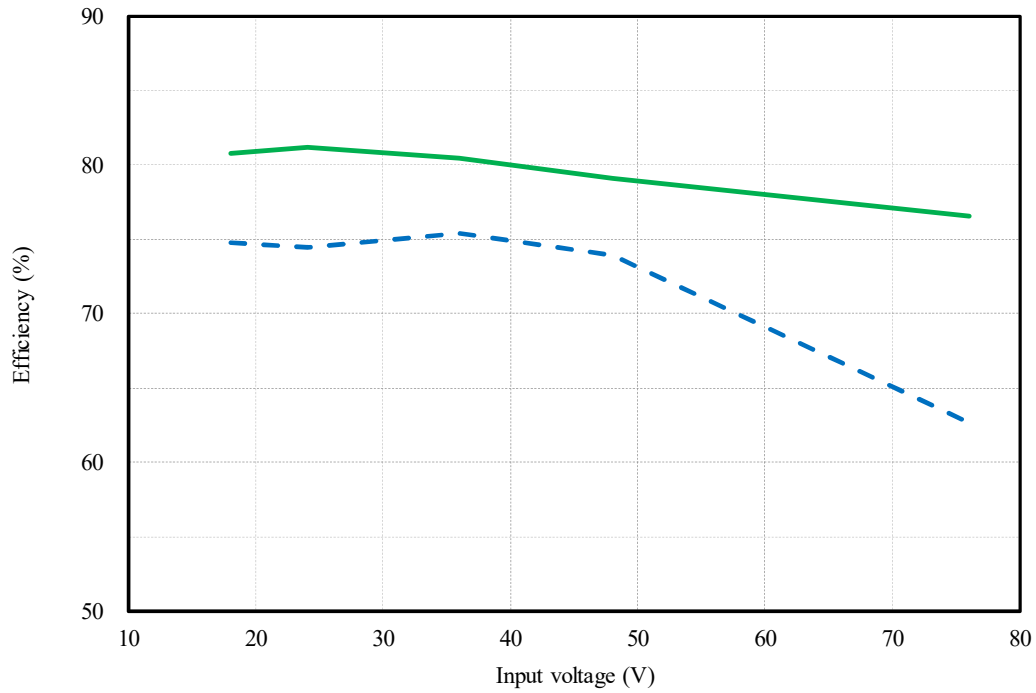

15V

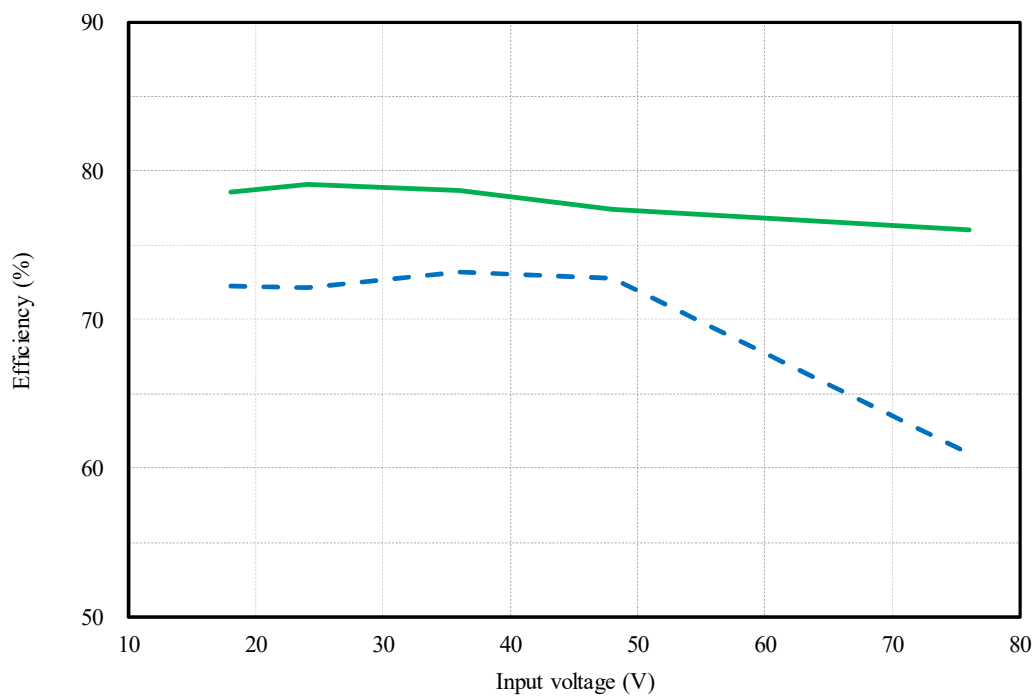

(5) 起動・遮断電圧特性 Start up and Drop out voltage characteristics

出力電圧 対 入力電圧

Output voltage vs. Input voltage

Conditions I_o : 100 %
 T_a : 25 °C

入力電流 対 入力電圧

Input current vs. Input voltage

Conditions I_o : 100 %
 T_a : 25 °C

3.3V

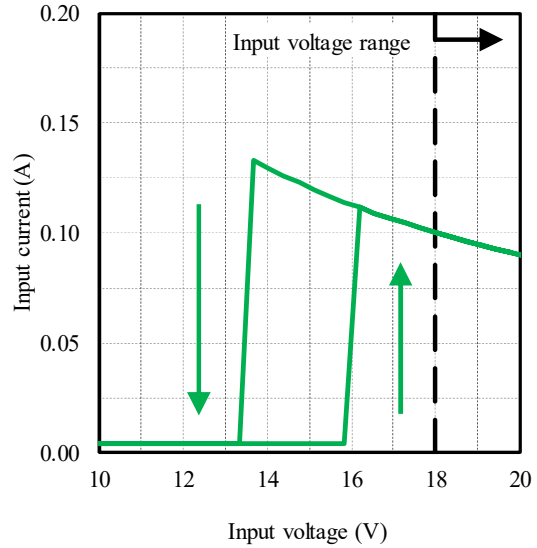
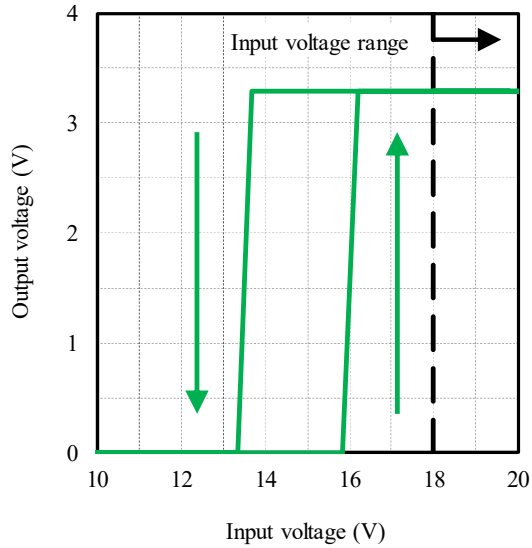

5V

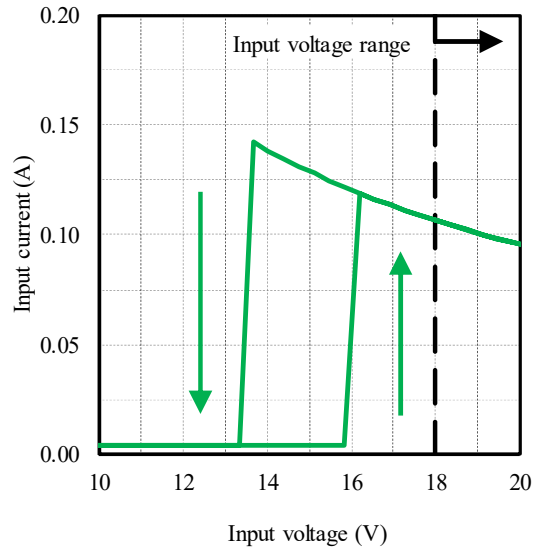
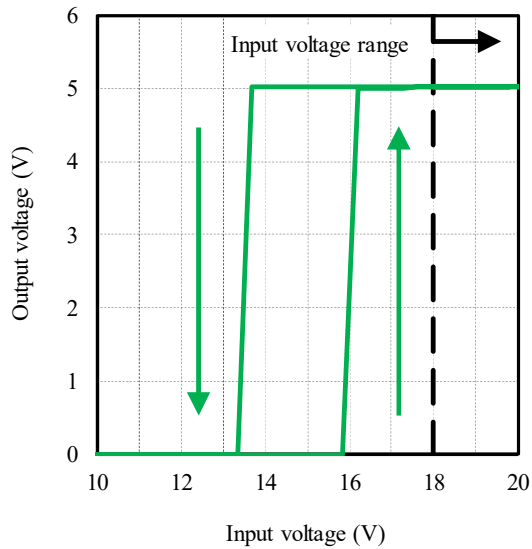

(5) 起動・遮断電圧特性 Start up and Drop out voltage characteristics

出力電圧 対 入力電圧

Output voltage vs. Input voltage

Conditions I_o : 100 %
 T_a : 25 °C

入力電流 対 入力電圧

Input current vs. Input voltage

Conditions I_o : 100 %
 T_a : 25 °C

12V

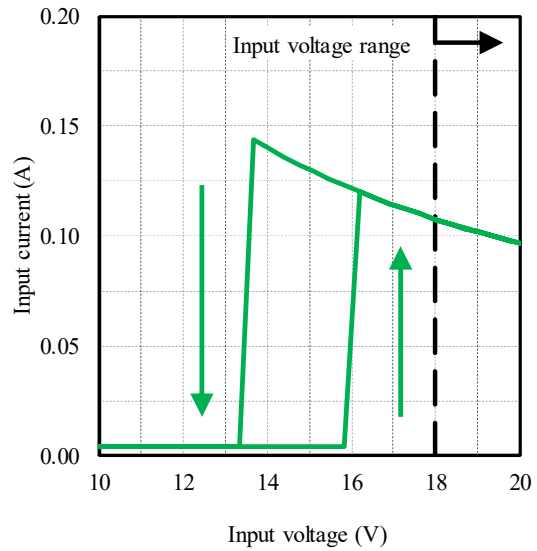
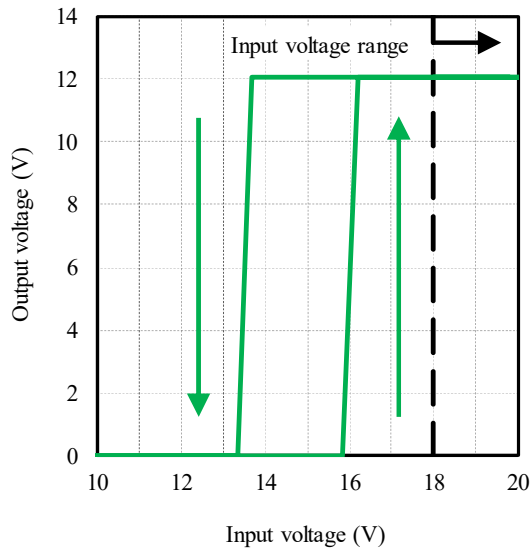

15V

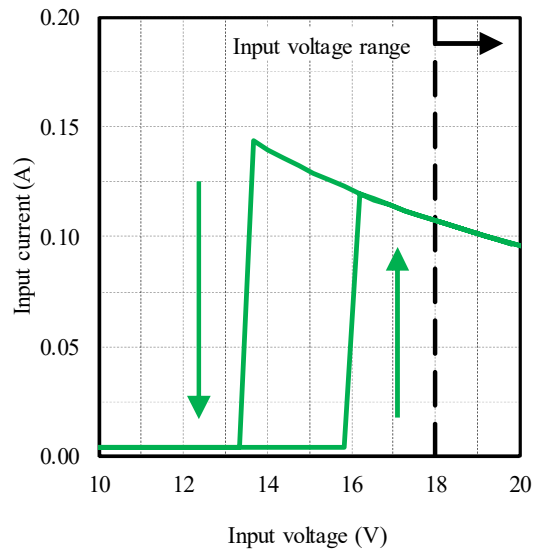
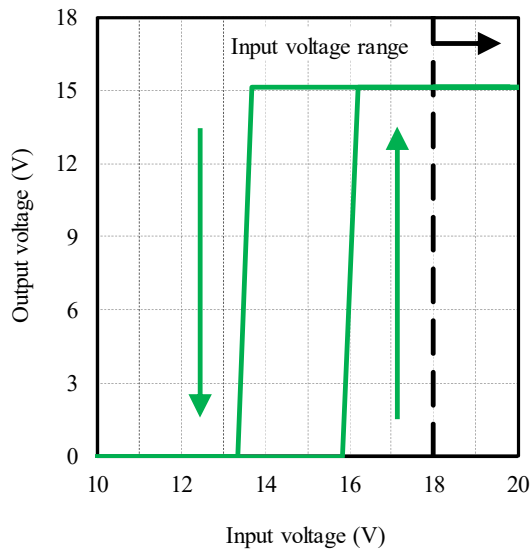

2-2. 待機電力特性 Standby power characteristics

Condition Ta : 25 °C

3.3V

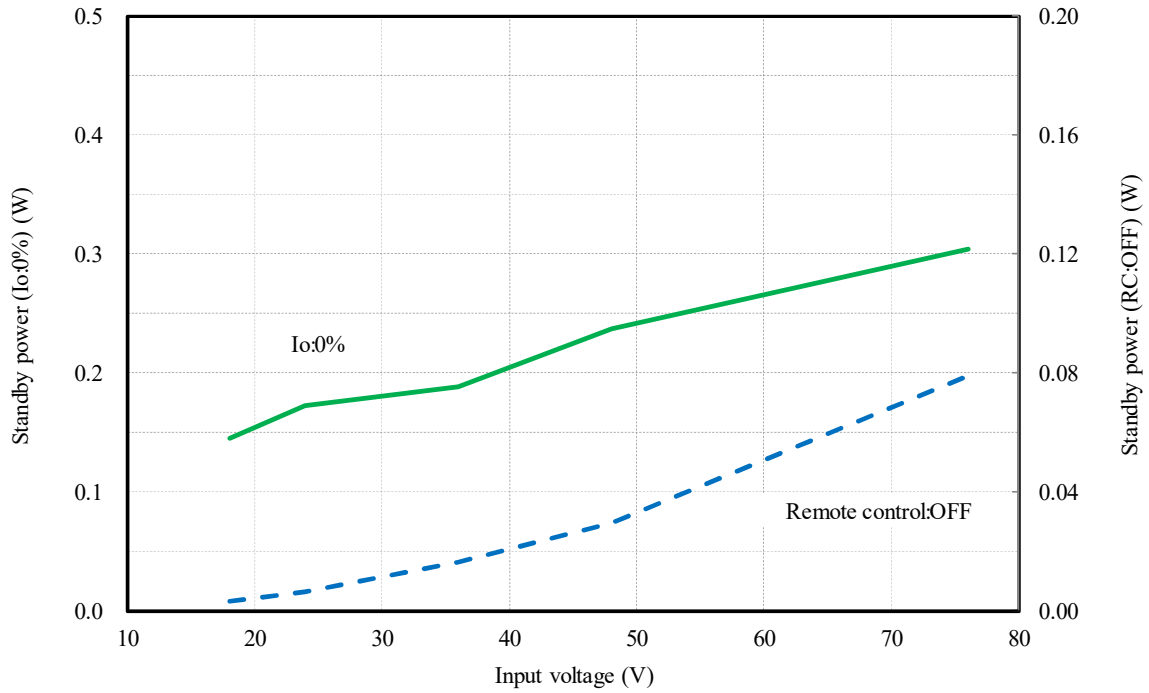

5V

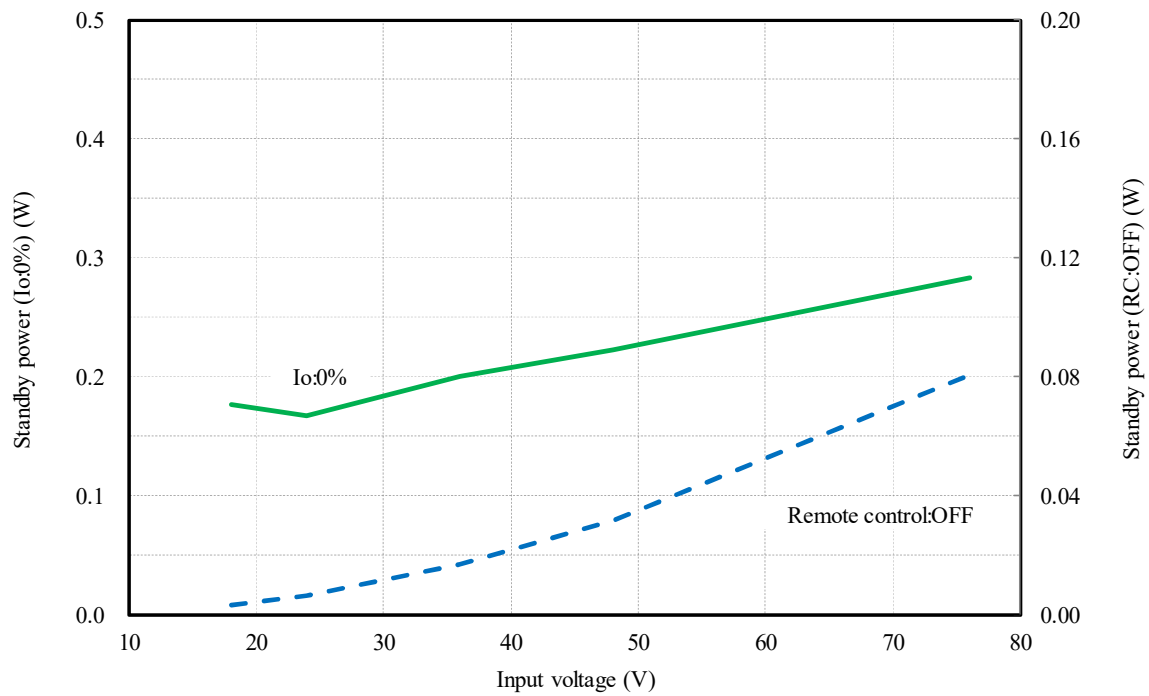

2-2. 待機電力特性 Standby power characteristics

Condition Ta : 25 °C

12V

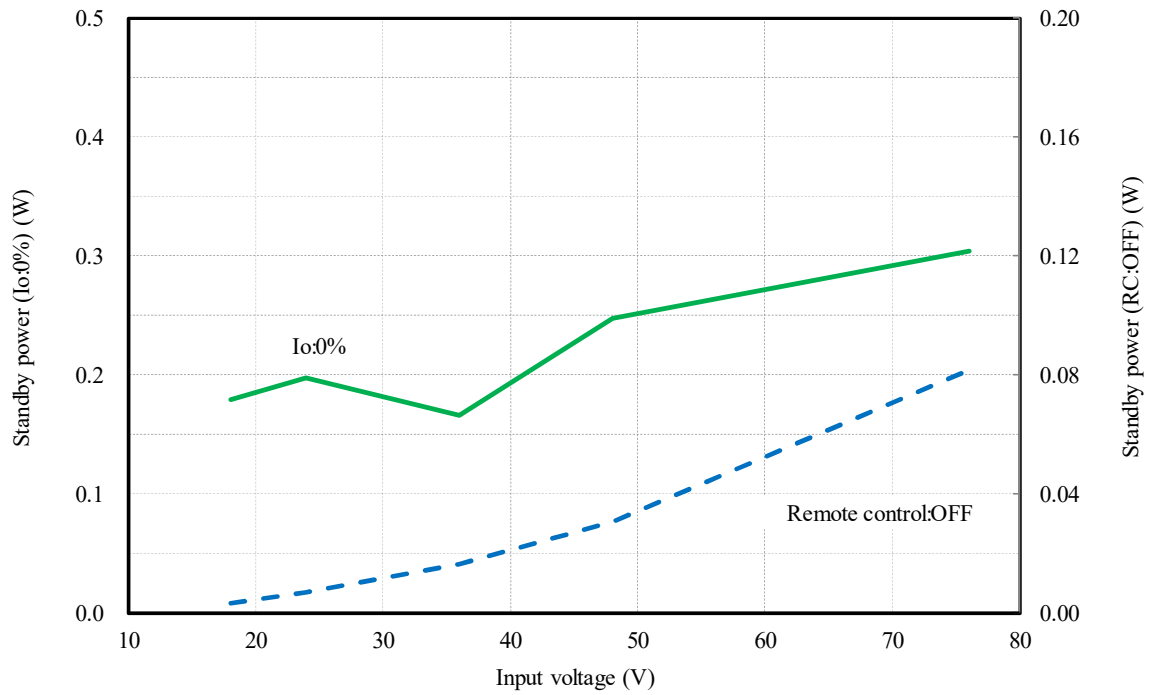

15V

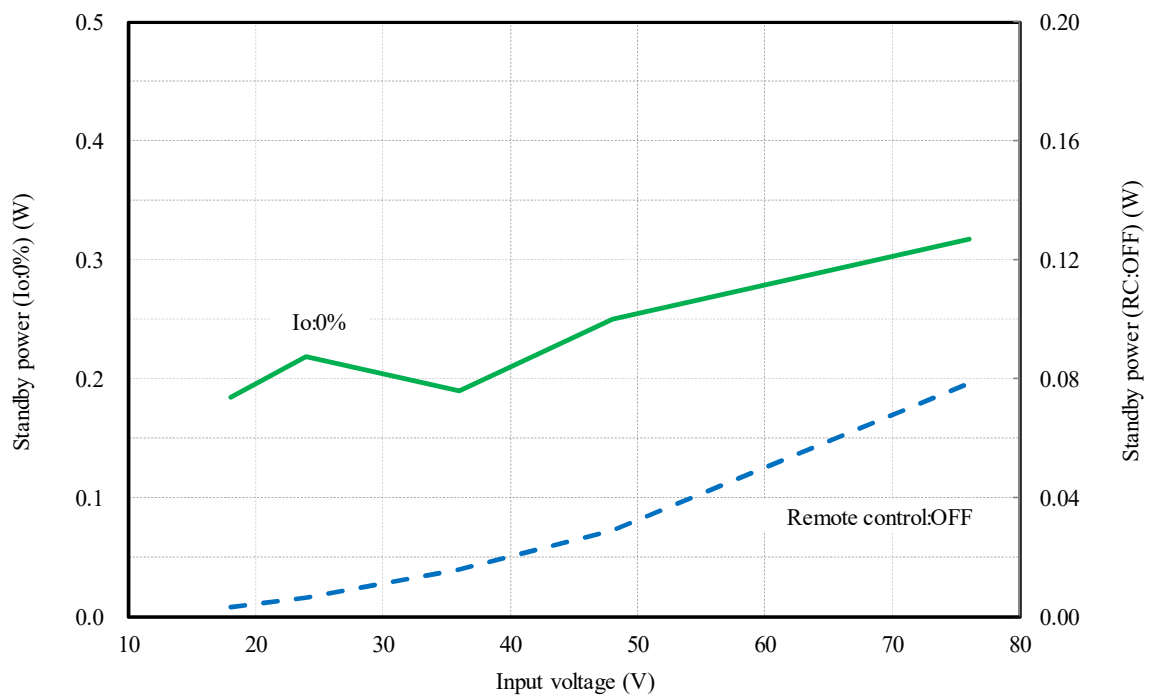

2-3. 通電ドリフト特性 Warm up voltage drift characteristics

Conditions Vin : 48 VDC
Io : 100 %
Ta : 25 °C

3.3V

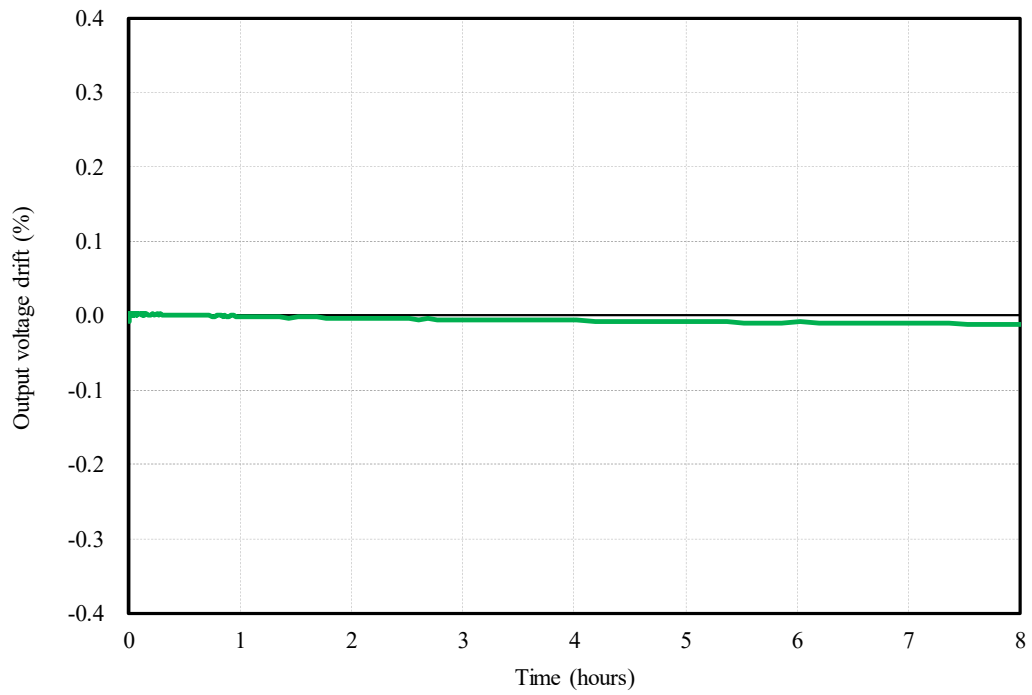

5V

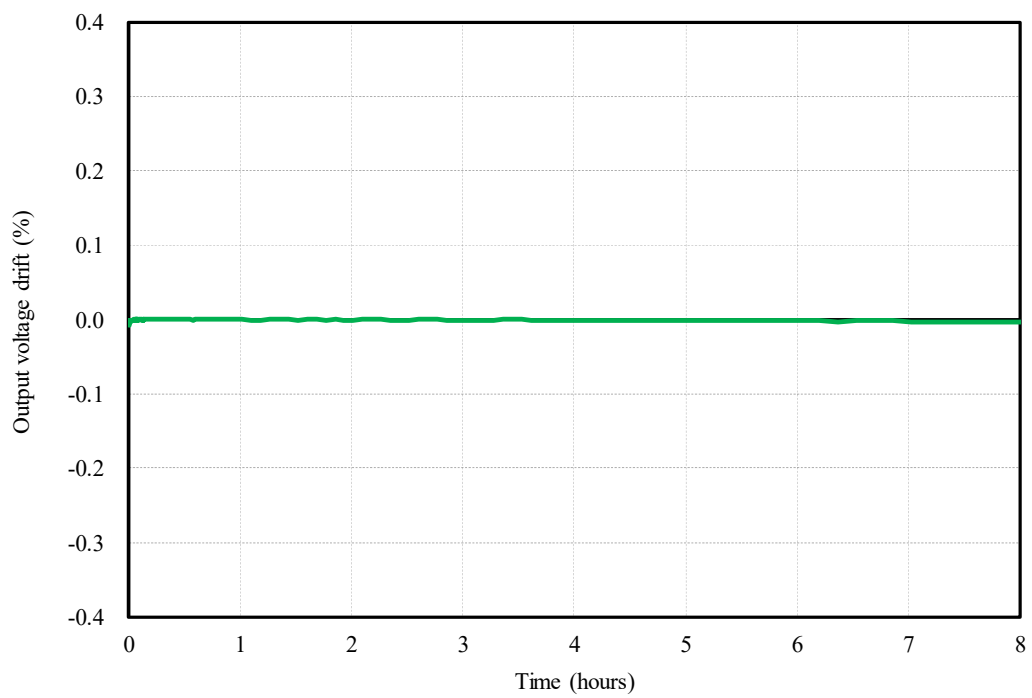

2-3. 通電ドリフト特性 Warm up voltage drift characteristics

Conditions Vin : 48 VDC
Io : 100 %
Ta : 25 °C

12V

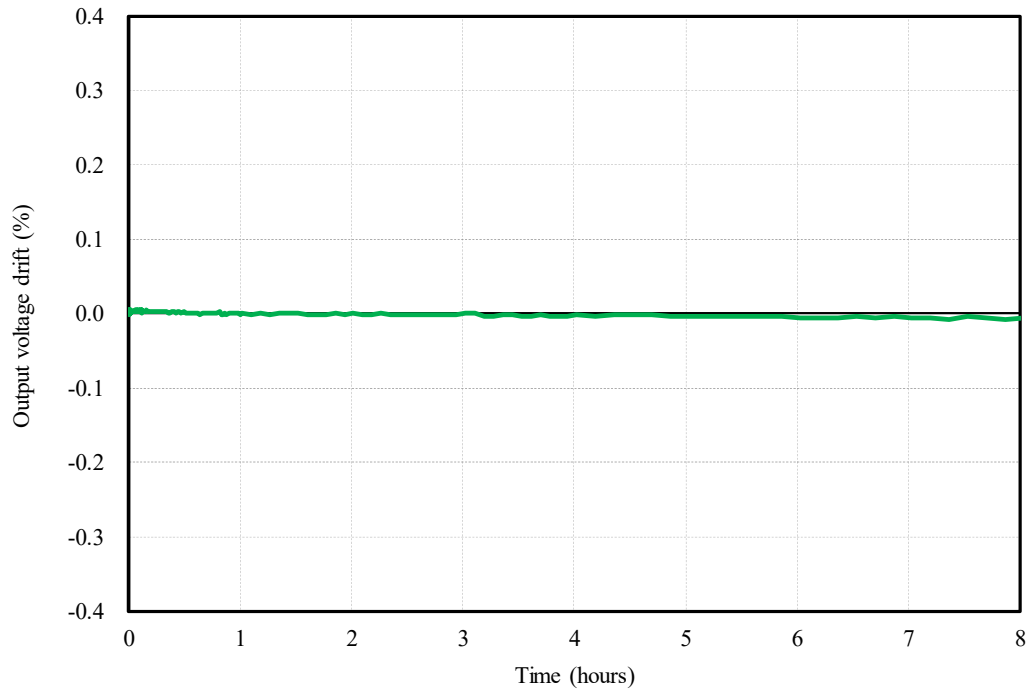

15V

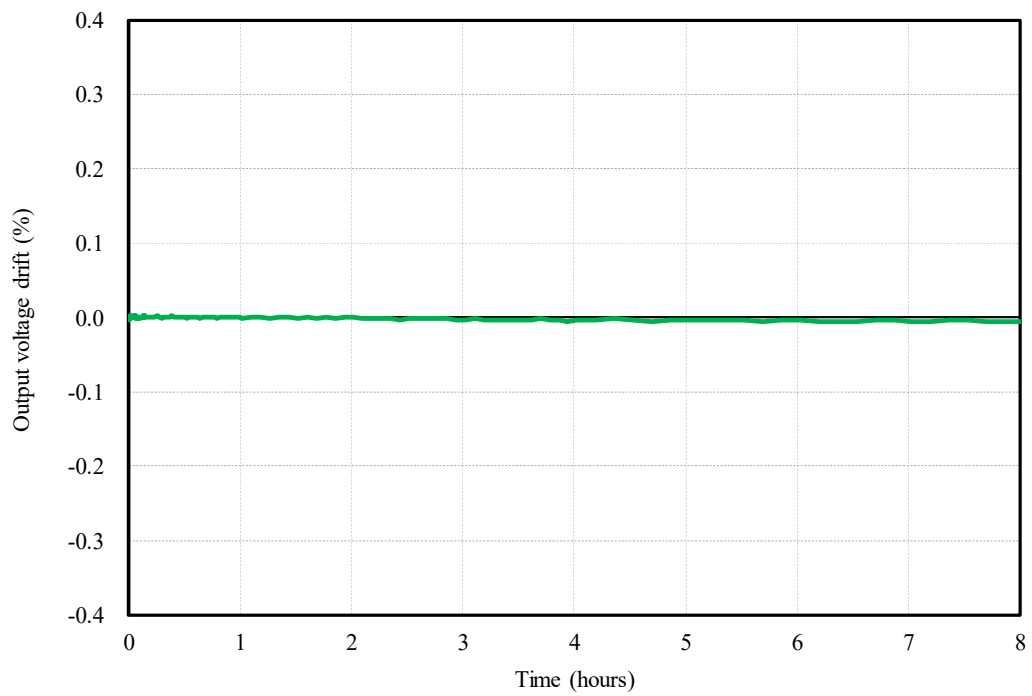

2-4. 過電流保護特性 Over current protection (OCP) characteristics

入力電圧依存性

Input voltage dependence

Conditions Vin : 18 VDC ———
 : 24 VDC - - -
 : 48 VDC ———
 : 76 VDC - - -
 Ta : 25 °C

周囲温度依存性

Ambient temperature dependence

Conditions Vin : 48 VDC
 Ta : -40 °C - - -
 : 25 °C ———
 : 85 °C - - -

3.3V

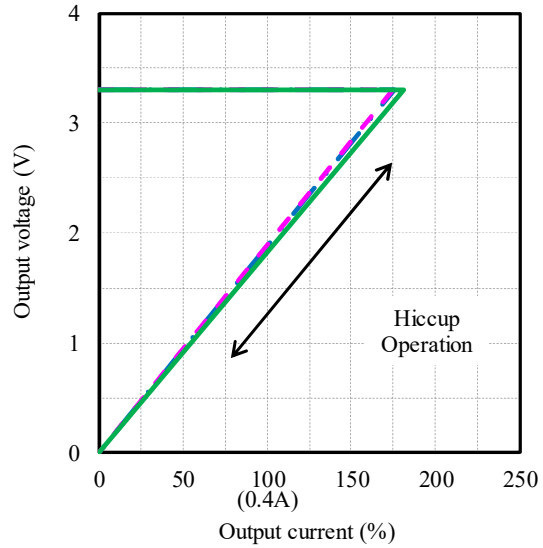
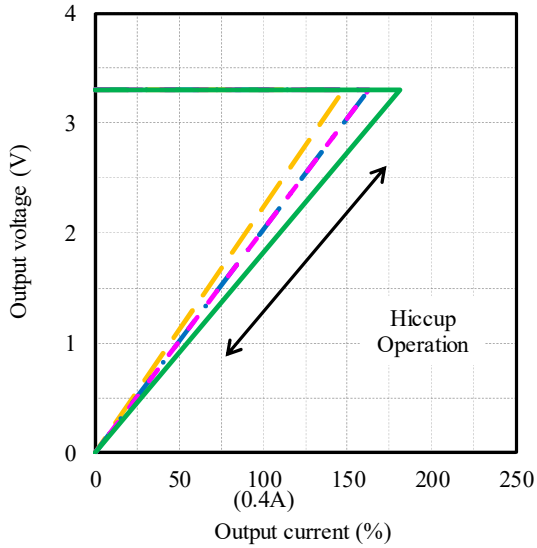

5V

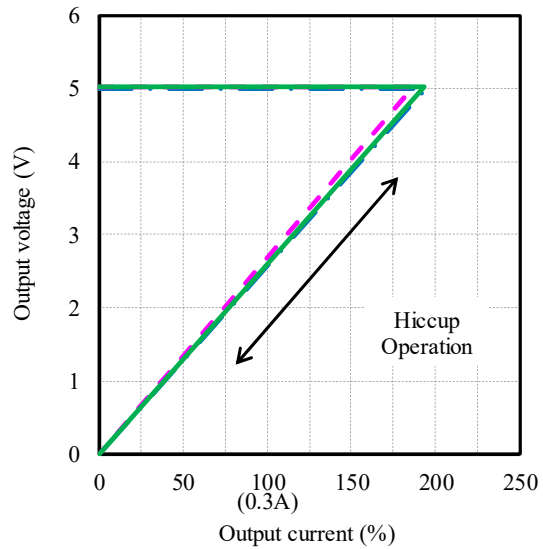
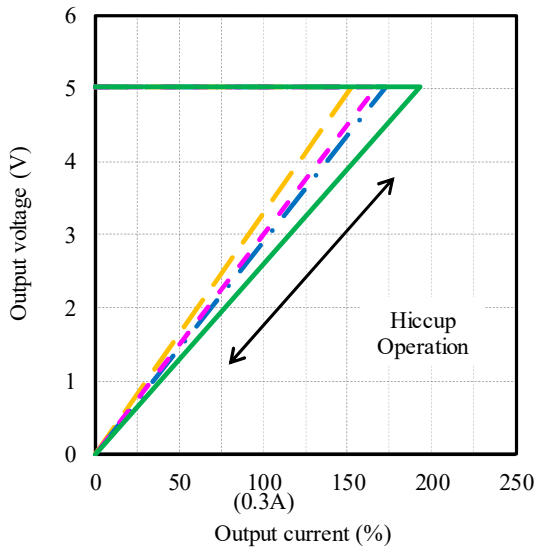

2-4. 過電流保護特性 Over current protection (OCP) characteristics

入力電圧依存性

Input voltage dependence

Conditions Vin : 18 VDC ———
 : 24 VDC - - -
 : 48 VDC ———
 : 76 VDC - - -
 Ta : 25 °C

周囲温度依存性

Ambient temperature dependence

Conditions Vin : 48 VDC
 Ta : -40 °C - - -
 : 25 °C ———
 : 85 °C - - -

12V

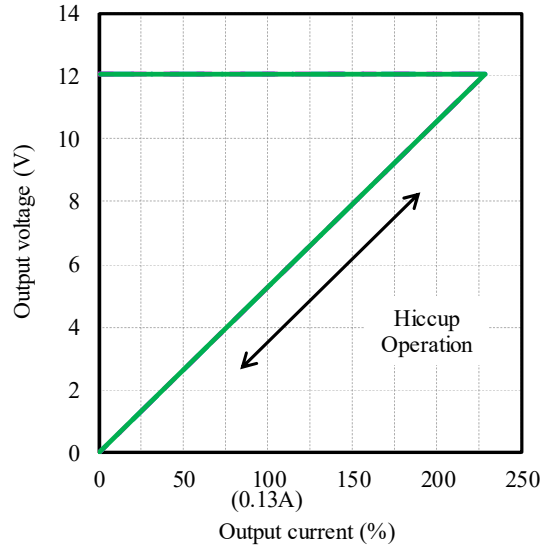
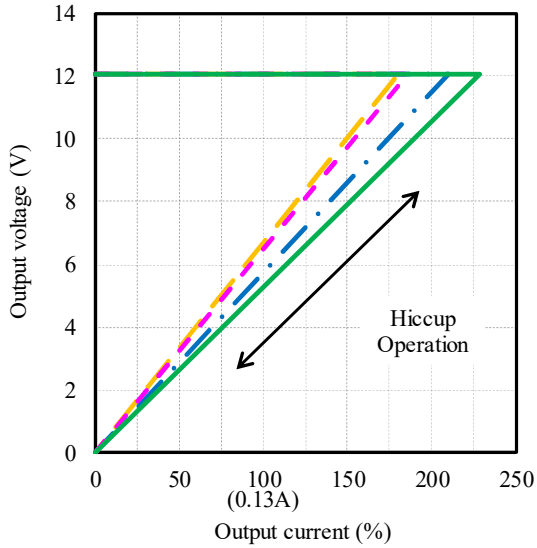

15V

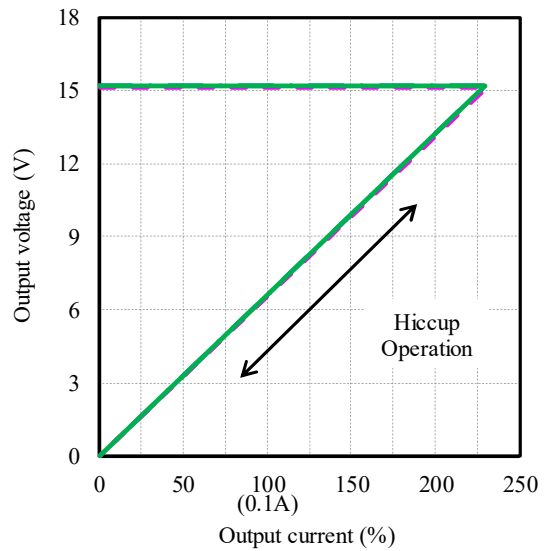
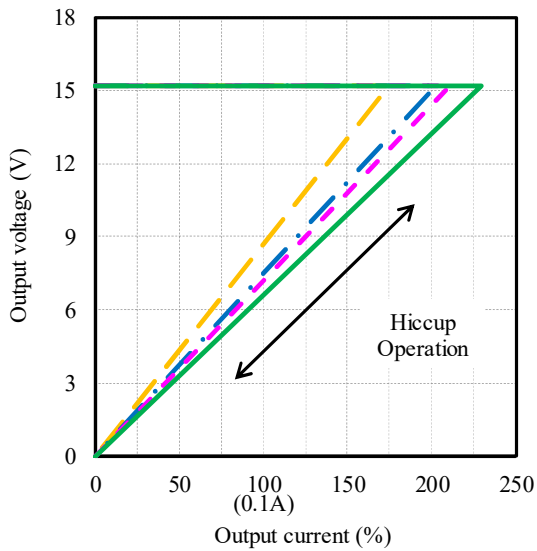

2-5. 出力立ち上がり・立ち下がり特性 Output rise and fall characteristics

Conditions V_{in} : 48 VDC
 I_o : 0 %
 T_a : 25 °C

3.3V

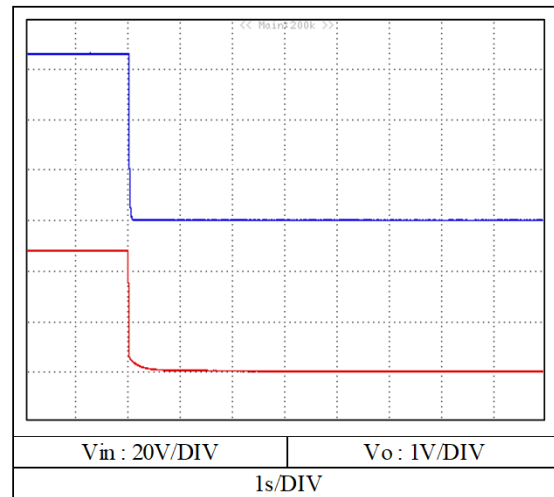
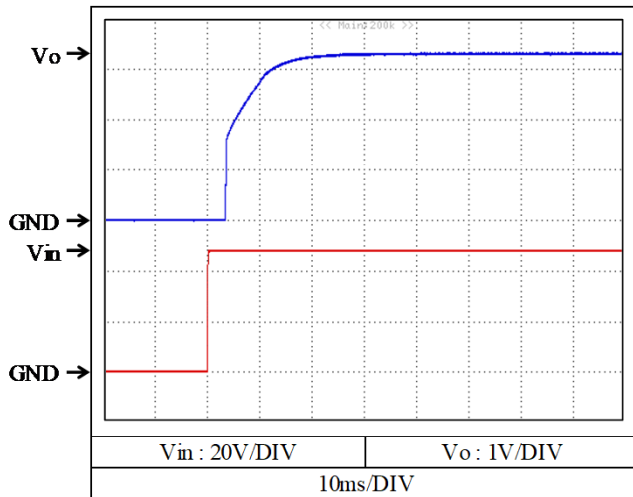

5V

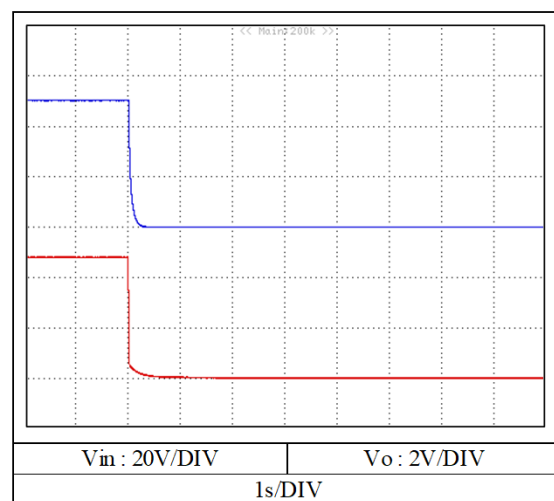
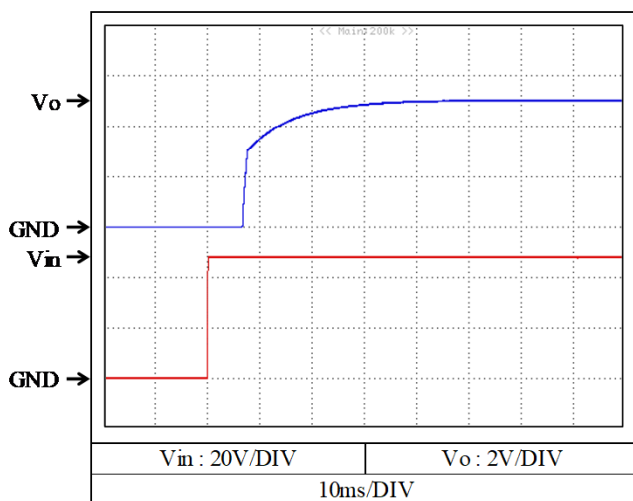

2-5. 出力立ち上がり・立ち下がり特性 Output rise and fall characteristics

Conditions V_{in} : 48 VDC
 I_o : 0 %
 T_a : 25 °C

12V

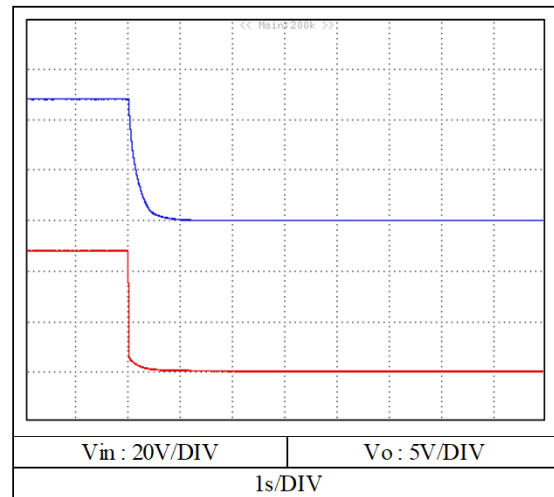
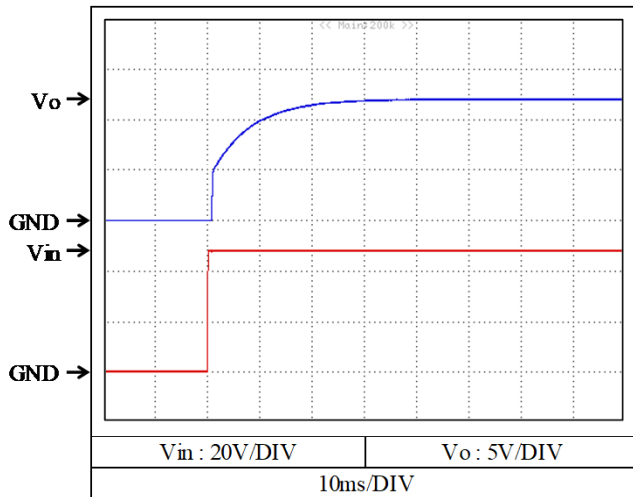

15V

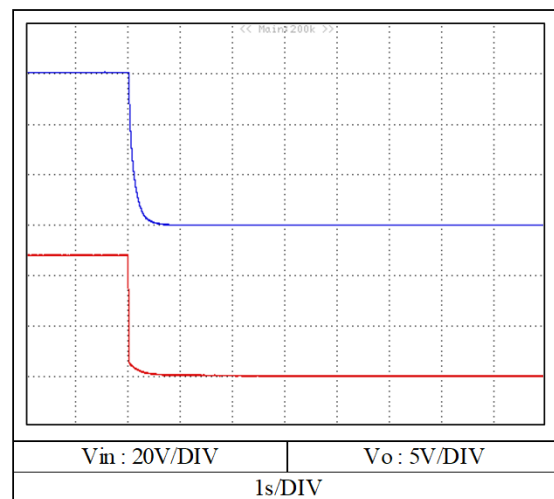
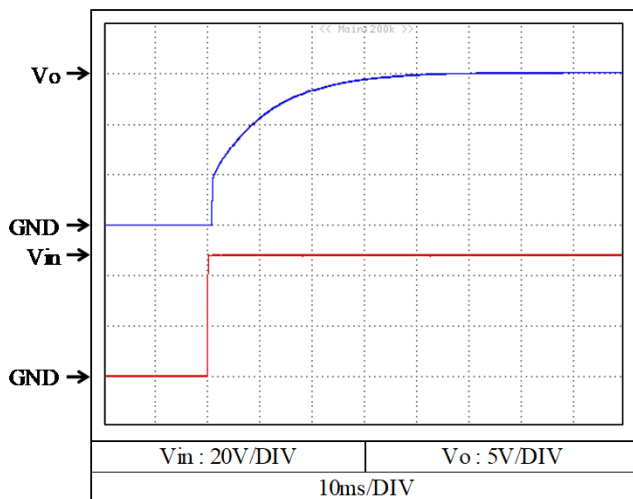

2-5. 出力立ち上がり・立ち下がり特性 Output rise and fall characteristics

Conditions V_{in} : 48 VDC
 I_o : 100 %
 T_a : 25 °C

3.3V

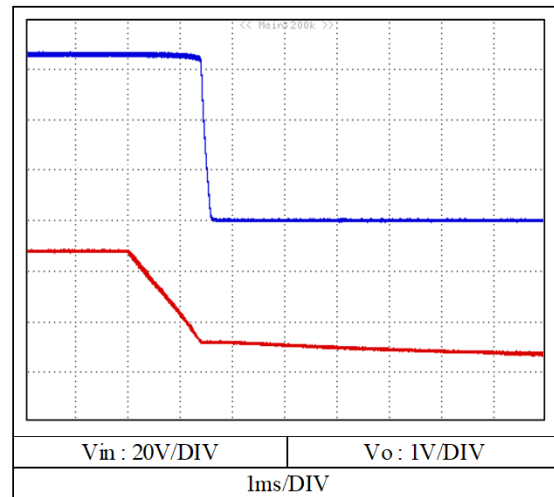
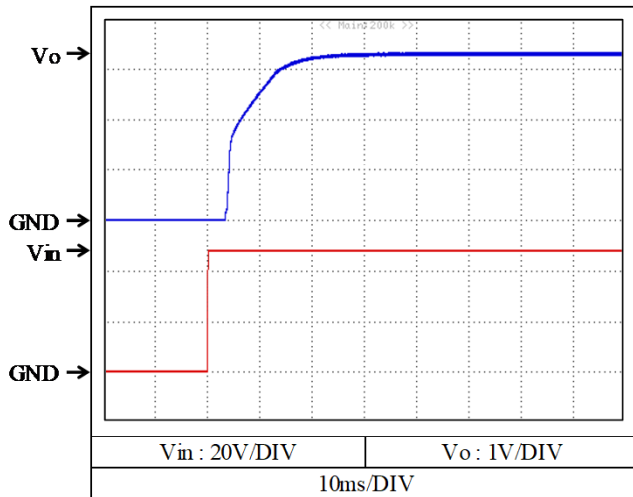

5V

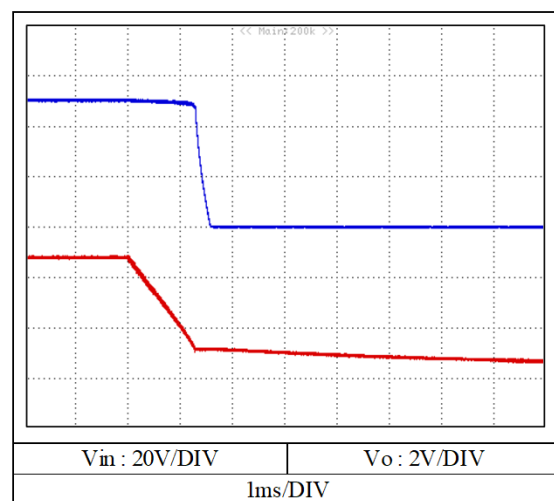
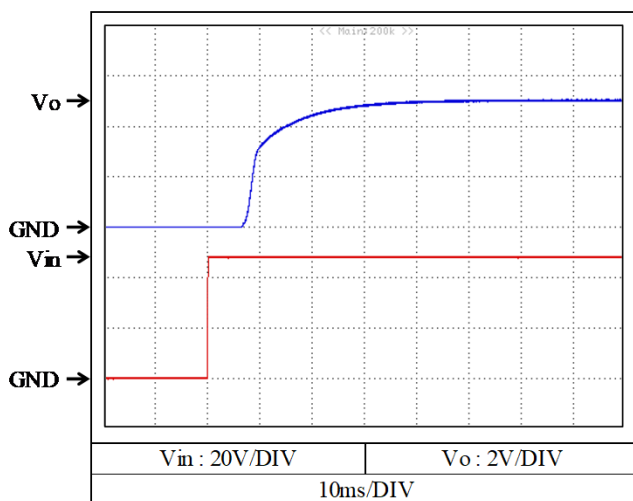

2-5. 出力立ち上がり・立ち下がり特性 Output rise and fall characteristics

Conditions V_{in} : 48 VDC
 I_o : 100 %
 T_a : 25 °C

12V

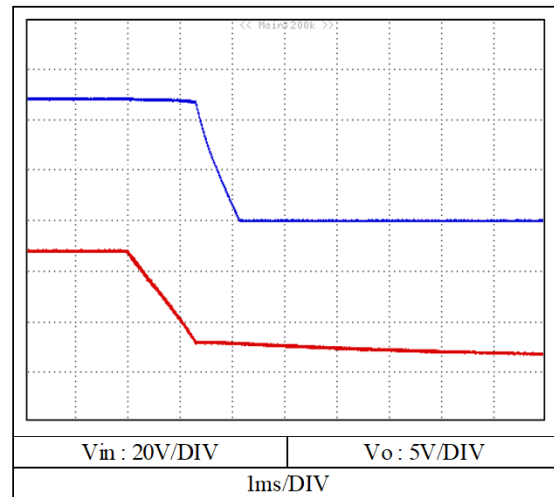
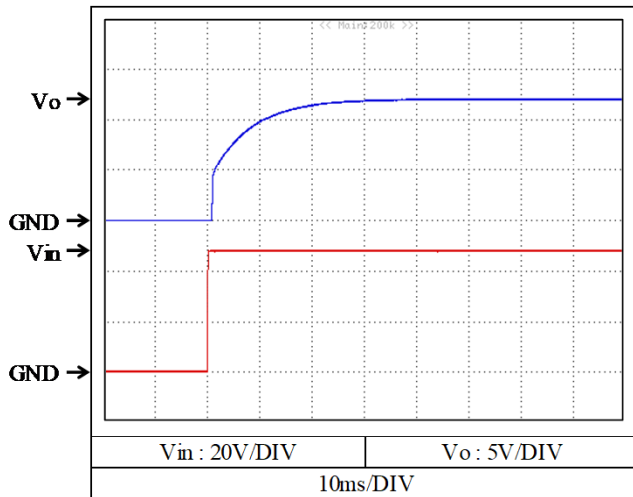

15V

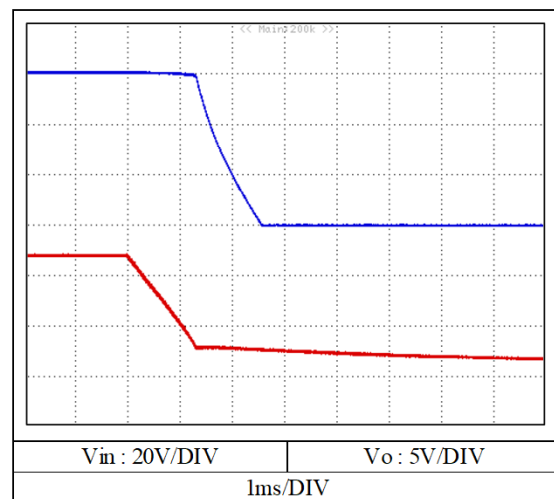
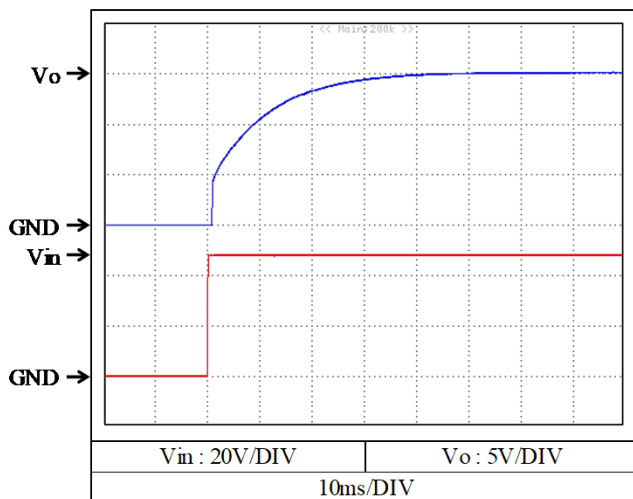

2-5. 出力立ち上がり・立ち下がり特性 (リモートON/OFFコントロール時)

Output rise and fall characteristics with REMOTE ON/OFF CONTROL

Conditions V_{in} : 48 VDC
 I_o : 0 %
 T_a : 25 °C

3.3V

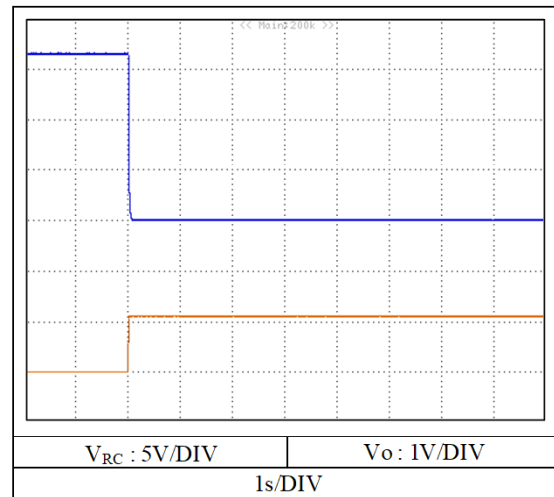
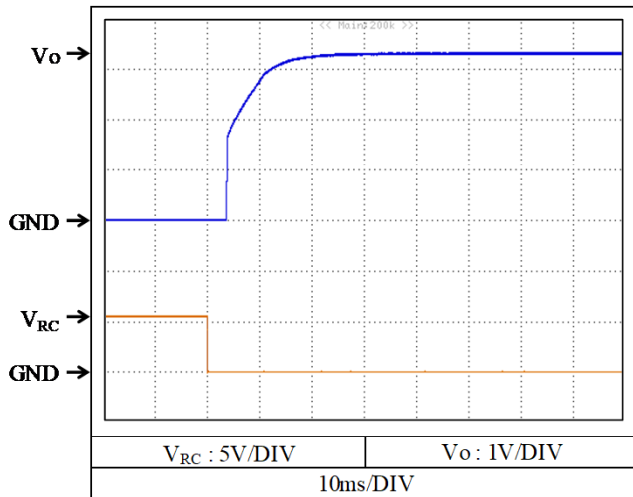

5V

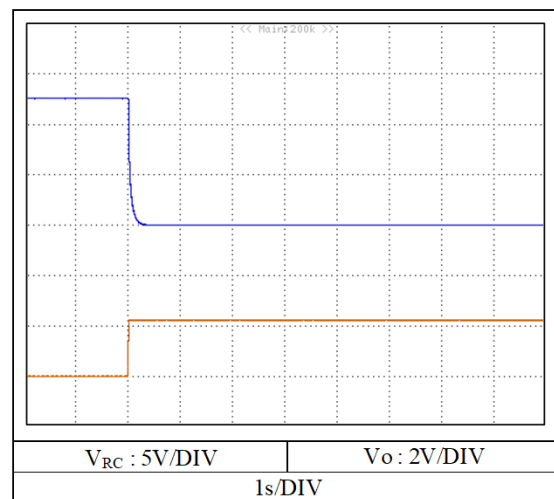
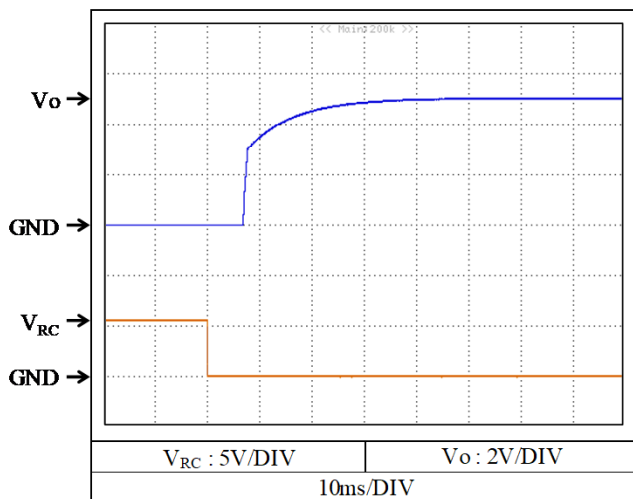

2-5. 出力立ち上がり・立ち下がり特性 (リモートON/OFFコントロール時)

Output rise and fall characteristics with REMOTE ON/OFF CONTROL

Conditions V_{in} : 48 VDC
 I_o : 0 %
 T_a : 25 °C

12V

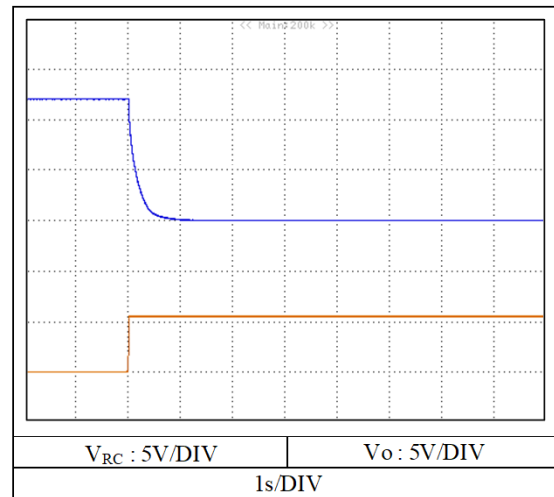
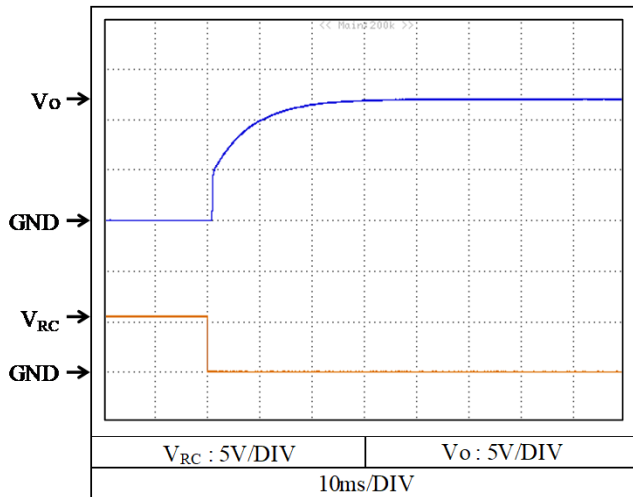

15V

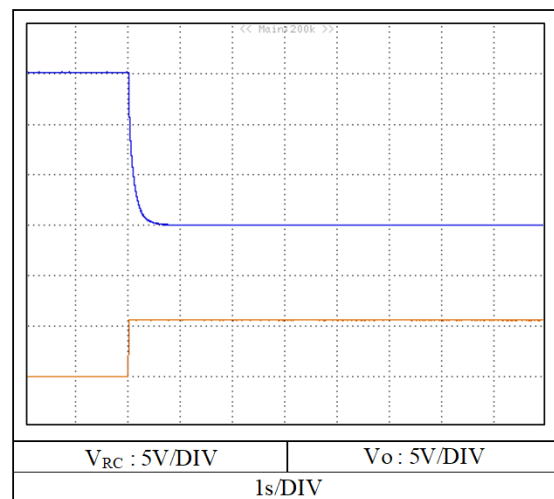
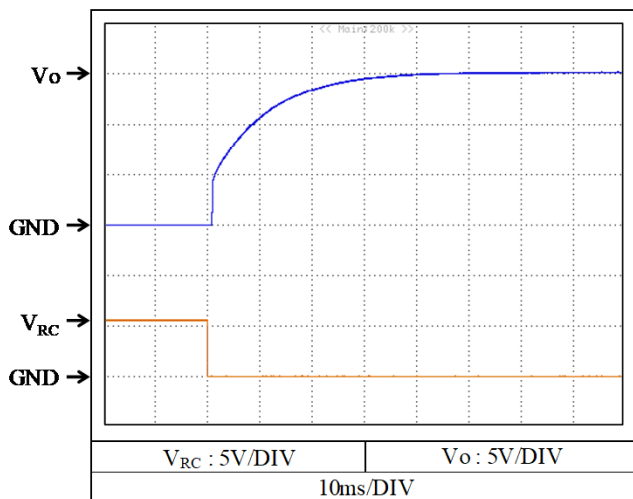

2-5. 出力立ち上がり・立ち下がり特性 (リモートON/OFFコントロール時)

Output rise and fall characteristics with REMOTE ON/OFF CONTROL

Conditions V_{in} : 48 VDC
 I_o : 100 %
 T_a : 25 °C

3.3V

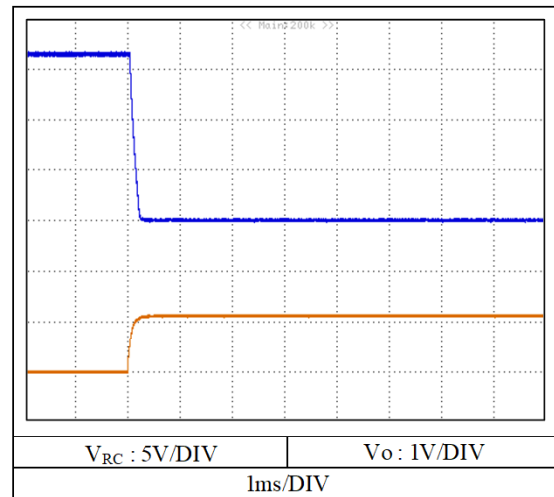
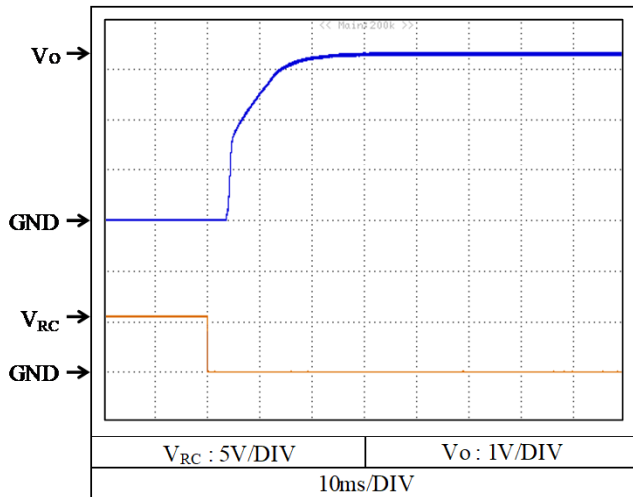

5V

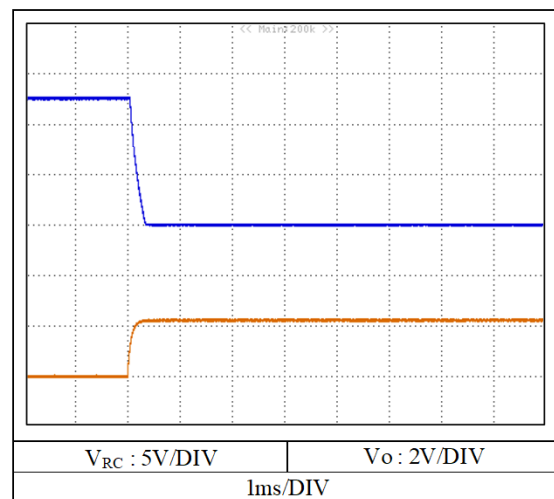
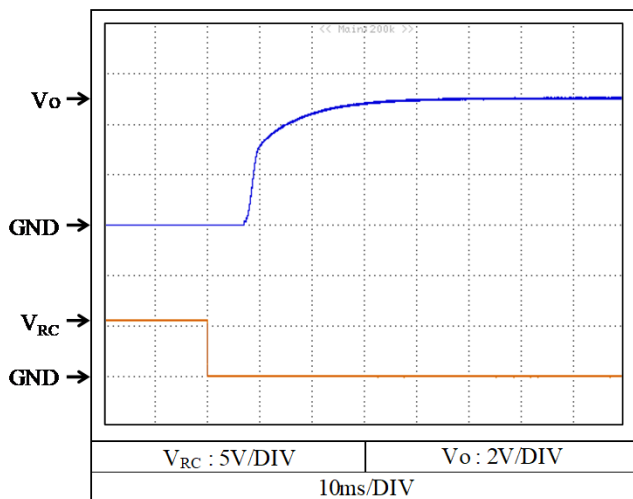

2-5. 出力立ち上がり・立ち下がり特性 (リモートON/OFFコントロール時)

Output rise and fall characteristics with REMOTE ON/OFF CONTROL

Conditions V_{in} : 48 VDC
 I_o : 100 %
 T_a : 25 °C

12V

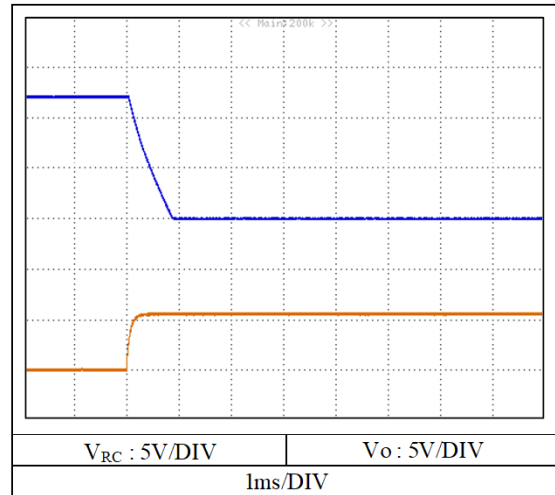
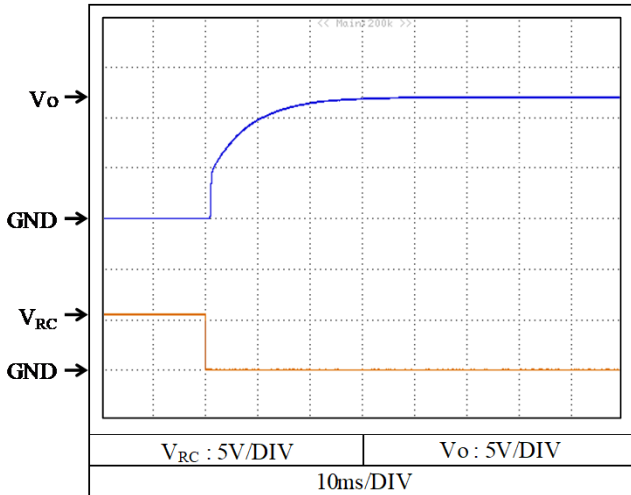

15V

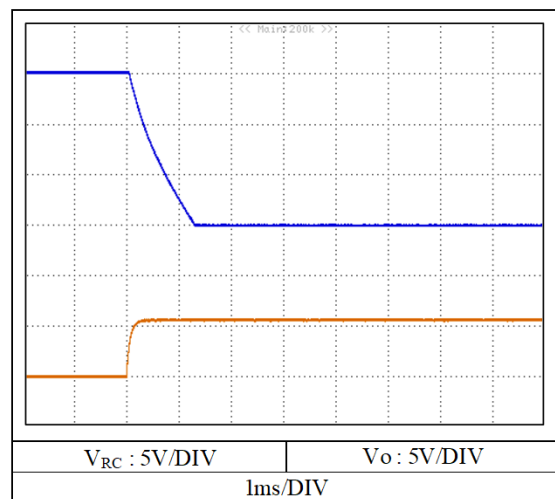
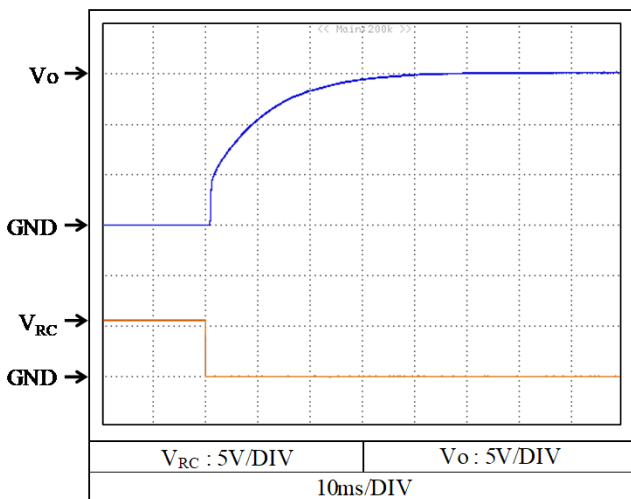

2-6. 過渡応答(負荷急変)特性 Dynamic load response characteristics

Conditions V_{in} : 48 VDC
 T_a : 25 °C

3.3V

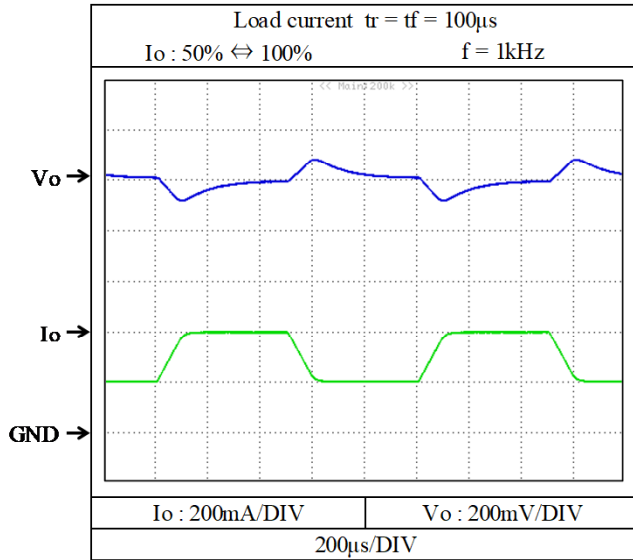

5V

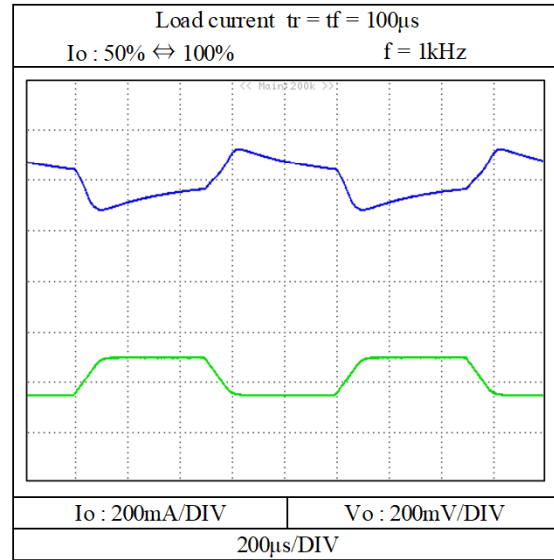

12V

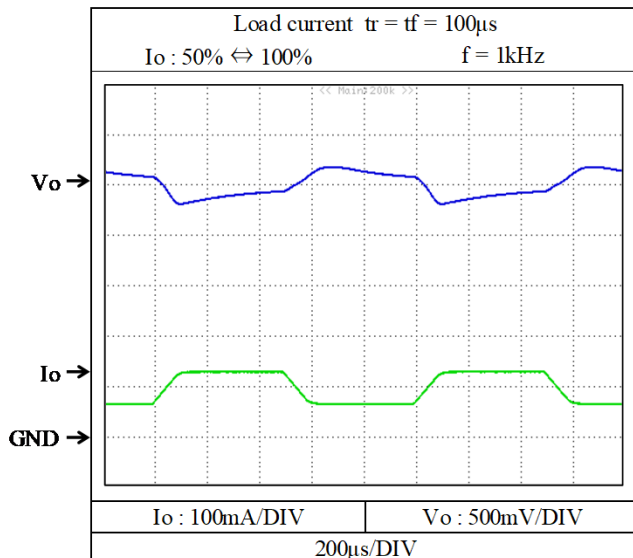

15V

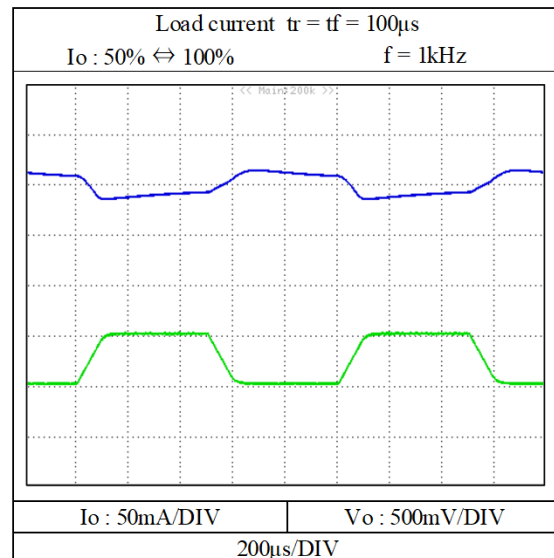

2-7. 入力サージ電流(突入電流)特性 Inrush current characteristics

Conditions V_{in} : 48 VDC
 I_o : 100 %
 T_a : 25 °C

CCG3-48-05S

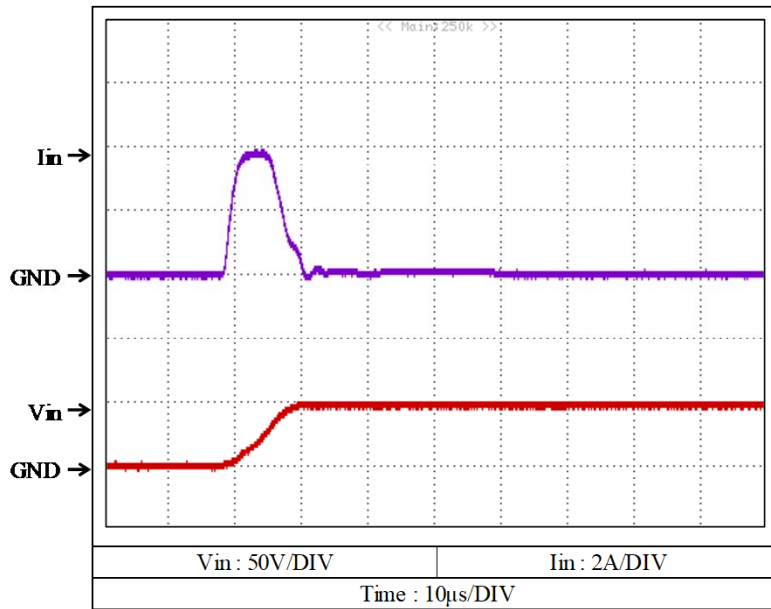

CCG1R5-48-xxSの入力サージ電流特性は CCG3-48-05S と同等です。
 CCG1R5-48-xxS have the same Inrush current characteristics as CCG3-48-05S data.

2-8. 出力リップルノイズ波形 Output ripple and noise waveform

Conditions V_{in} : 48 VDC
 I_o : 100 %
 T_a : 25 °C

3.3V

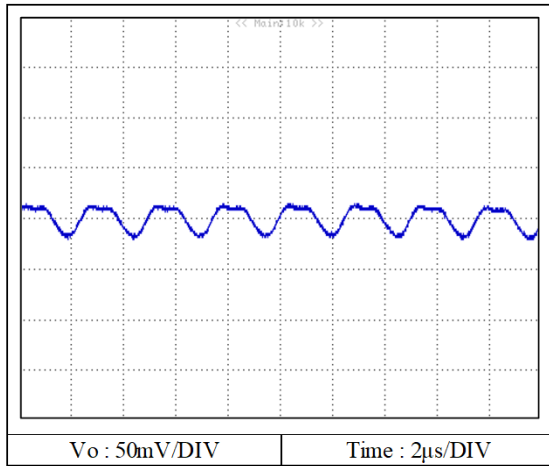

5V

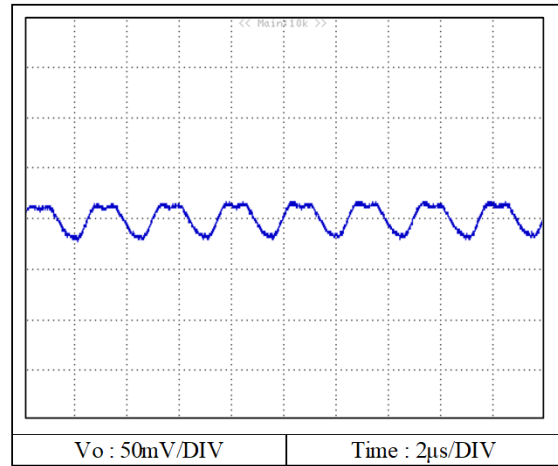

12V

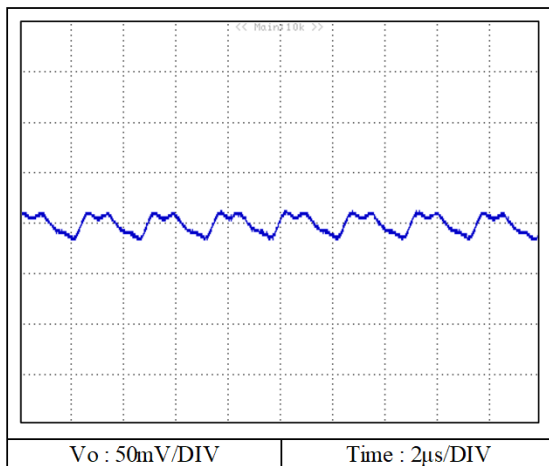

15V

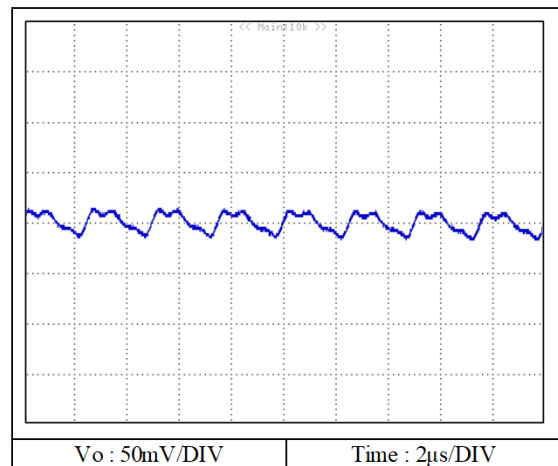

2-9. EMI特性 Electro-Magnetic Interference characteristics

(a) 雑音端子電圧 (帰還ノイズ) Conducted Emission Noise

Conditions Vin : 48 VDC
 Io : 100 %
 Ta : 25 °C

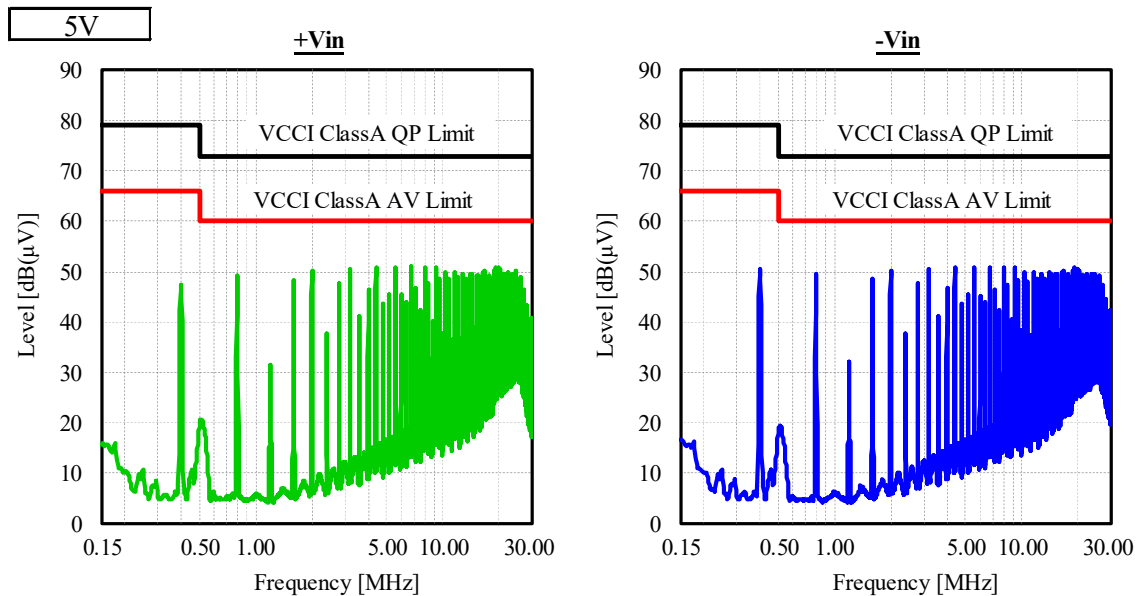
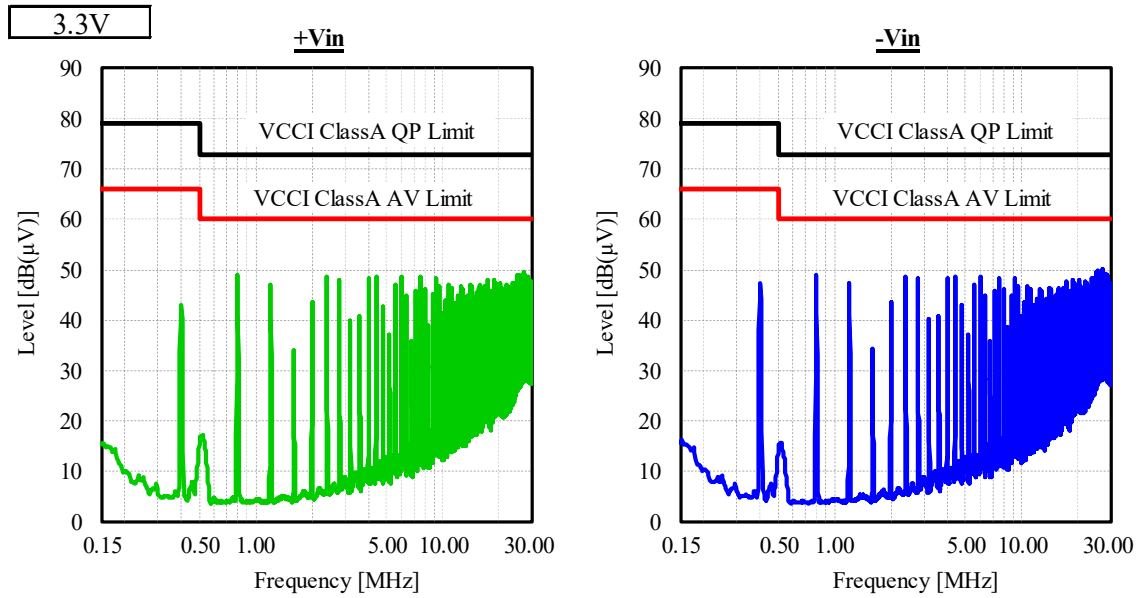

表示はQP値
 Indication is QP values.

2-9. EMI特性 Electro-Magnetic Interference characteristics

(a) 雑音端子電圧 (帰還ノイズ) Conducted Emission Noise

Conditions Vin : 48 VDC
Io : 100 %
Ta : 25 °C

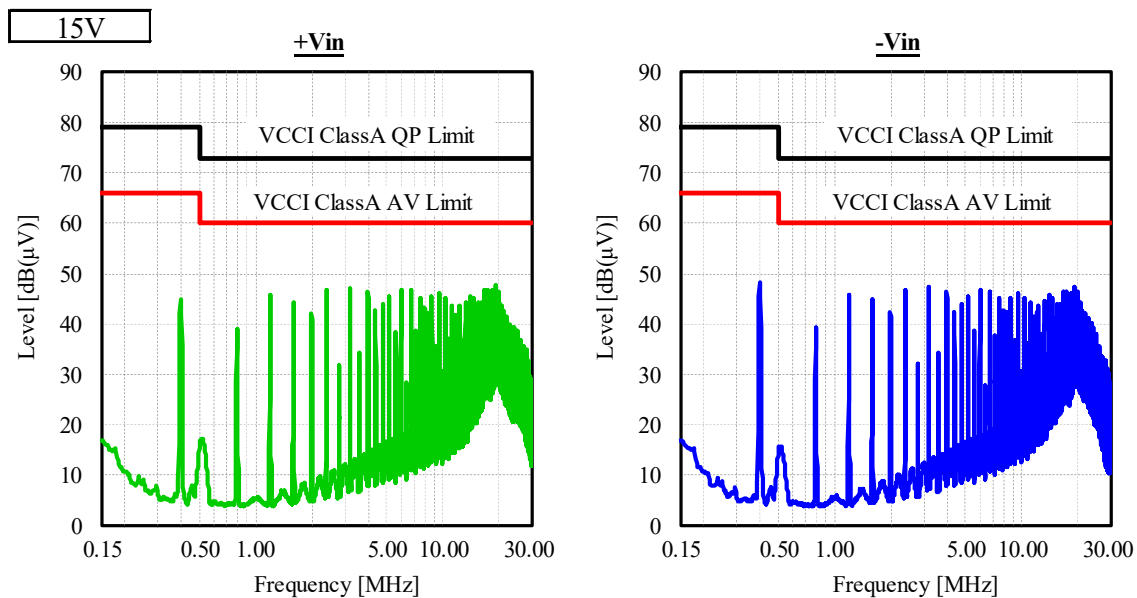
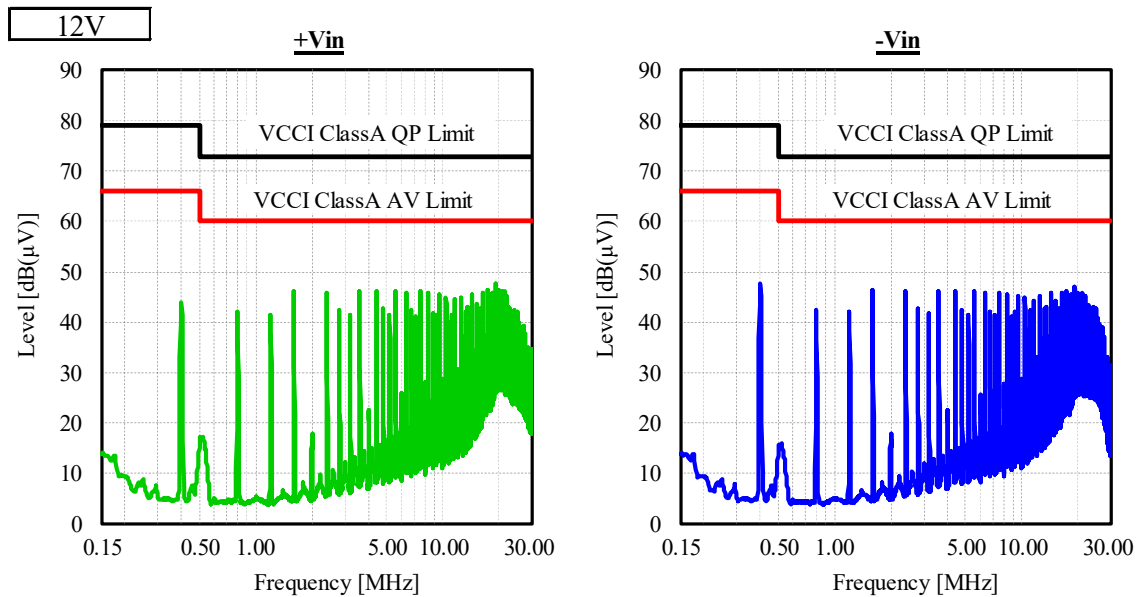

表示はQP値
Indication is QP values.

2-9. EMI特性 Electro-Magnetic Interference characteristics
 (b) 雑音電界強度 (輻射ノイズ) Radiated Emission Noise

Conditions Vin : 48 VDC
 Io : 100 %
 Ta : 25 °C

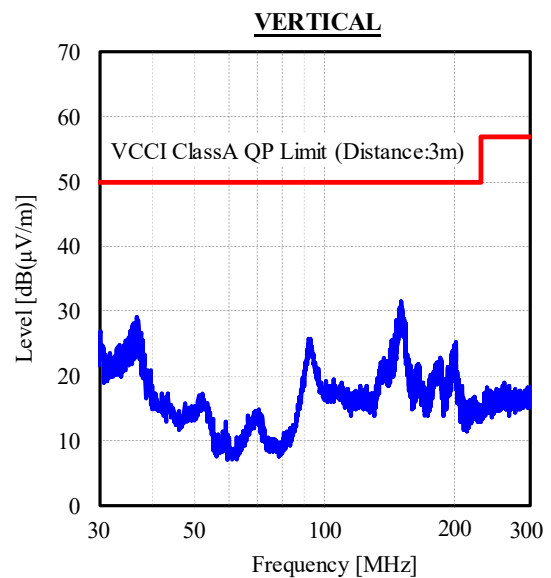
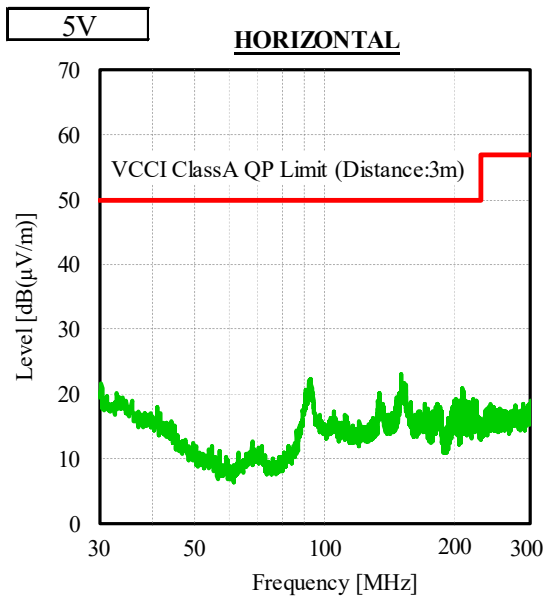
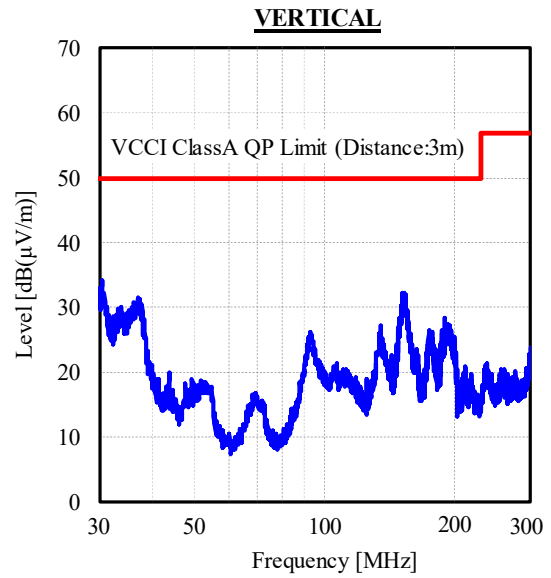
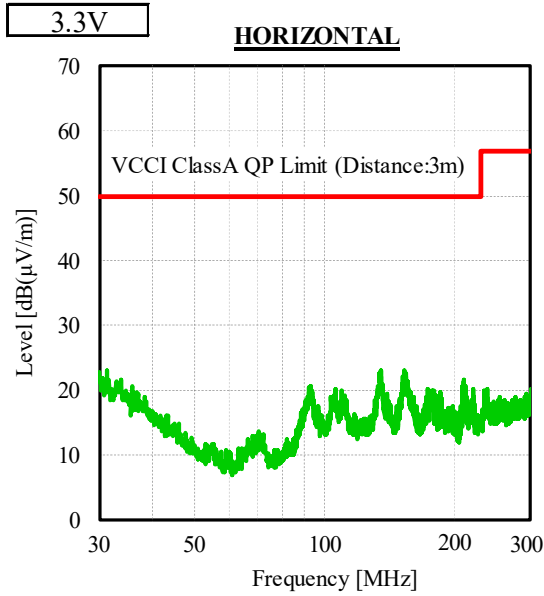

表示はピーク値
 Indication is peak values.

2-9. EMI特性 Electro-Magnetic Interference characteristics
 (b) 雑音電界強度 (輻射ノイズ) Radiated Emission Noise

Conditions Vin : 48 VDC
 Io : 100 %
 Ta : 25 °C

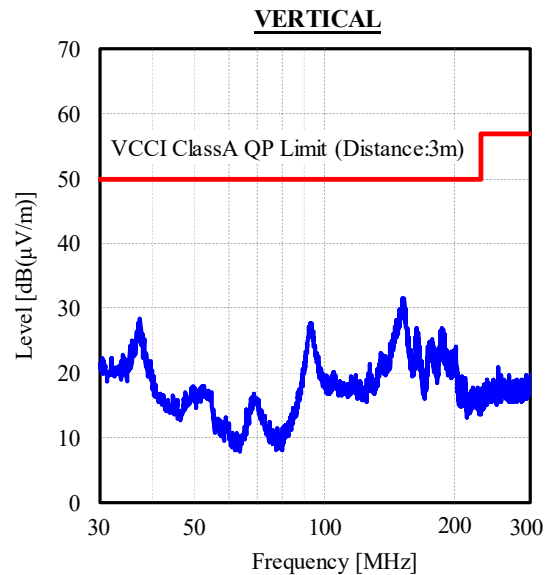
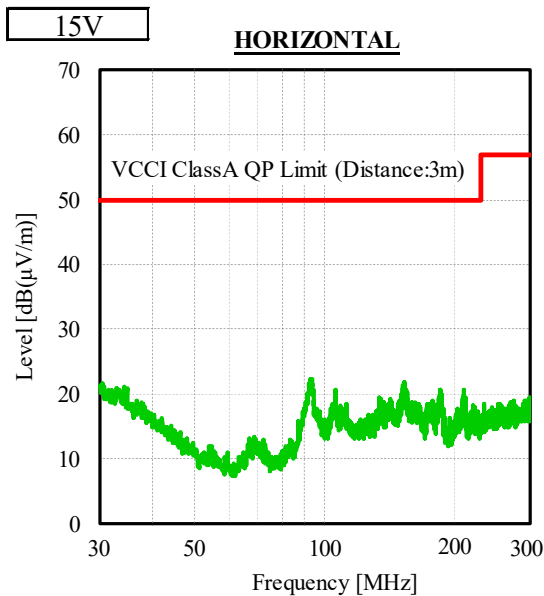
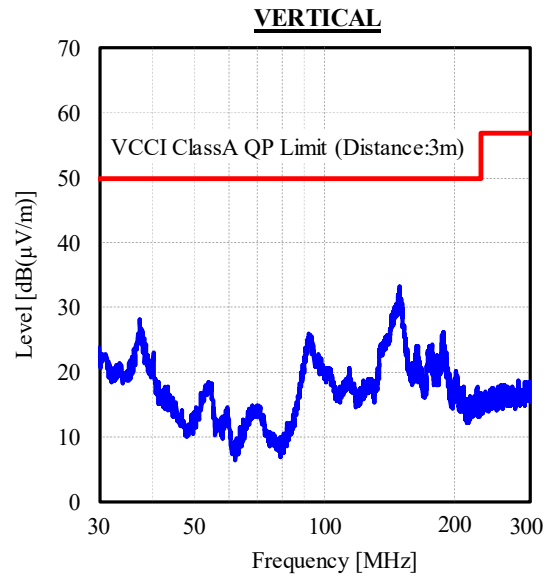
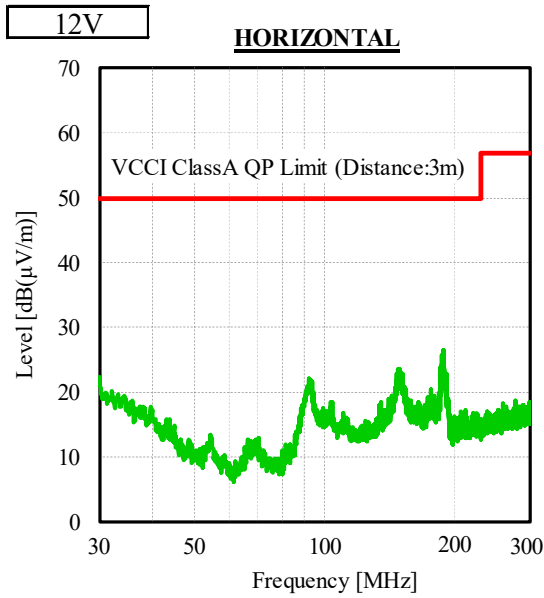

表示はピーク値
 Indication is peak values.