

PAH75S48-*

QUALITY TEST DATA



POWER MODULE

DRAWING NO. : PA549-53-01		
NLS R&D		
PREPARED	CHECKED	APPROVED
<i>Chloe</i> 3/9/99	<i>Anna</i> 3/9/99	<i>[Signature]</i> 3/9/99
DATE ISSUE : 3/9/99		

1. Evaluation Method	PAGE
1 - 1 Circuit used for determination	T - 1
(1) Steady state data	
(2) Warm up voltage drift characteristics	
(3) Over current protection (O.C.P.) characteristics	
(4) Over voltage protection (O.V.P.) characteristics	
(5) Output rise characteristics	
(6) Output fall characteristics	
(7) Output rise characteristics with ON / OFF control (negative logic)	
(8) Output fall characteristics with ON / OFF control (negative logic)	
(9) Dynamic load response characteristics	
(10) Inrush current waveform	
(11) Output-ripple , noise waveform	
(12) Leakage current characteristics	
(13) Dynamic line response characteristics	
(14) AC input response	
(15) Input reflected current	
1 - 2 List of equipment used	T - 6
2. Characteristics	
2 - 1 Steady state data	T - 7
(1) Regulation - line and load , temp. drift	
(2) Output voltage and ripple voltage v.s. input voltage	
(3) Efficiency and input current v.s.output current	
(4) Efficiency v.s. input voltage	
2 - 2 Warm up voltage drift characteristics	T - 11
2 - 3 Over current protection (O.C.P.) characteristics	T - 12
2 - 4 Over voltage protection (O.V.P.) characteristics	T - 14
2 - 5 Output rise characteristics	T - 15
2 - 6 Output fall characteristics	T - 17
2 - 7 Output rise characteristics with ON / OFF control (negative logic)	T - 19
2 - 8 Output fall characteristics with ON / OFF control (negative logic)	T - 21
2 - 9 Dynamic load response characteristics	T - 23
2 - 10 Inrush current waveform	T - 26
2 - 11 Output-ripple , noise waveform	T - 27
2 - 12 Leakage current characteristics	T - 30
2 - 13 Dynamic line response characteristics	T - 31
2 - 14 AC input response	T - 32
2 - 15 Input reflected current	T - 33

Terminology used

Vin - Input Voltage	Iout - Output Current
Vout - Output Voltage	Tp - Base-Plate Temperature
Iin - Input Current	Tr - Load Rise-Time
	Tf - Load Fall-Time

1. EVALUATION METHOD

1 - 1 Circuit used for determination

(1) Steady state data

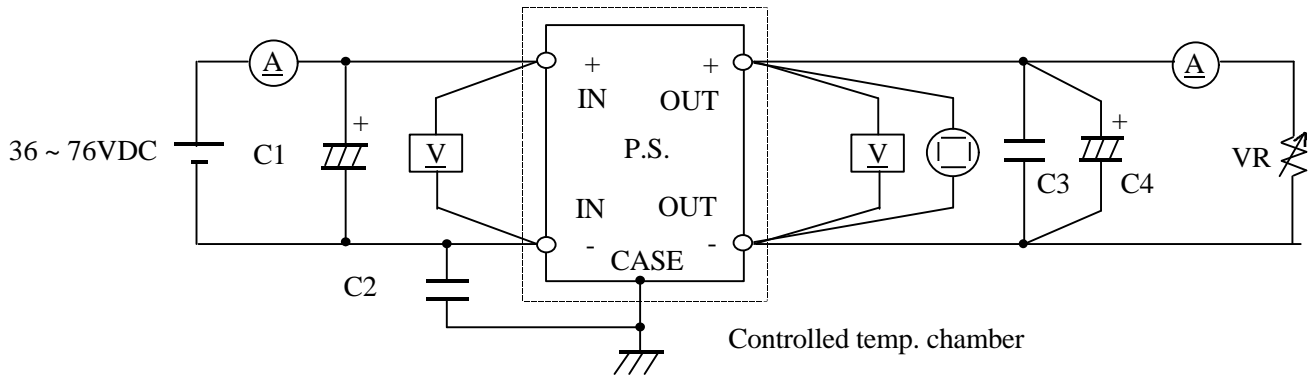

(i) $T_p = -20^{\circ}\text{C} \sim 100^{\circ}\text{C}$

C1 : 33 μF Electrolytic Capacitor

C2 : 4700pF Ceramic Capacitor

C3 : 1 μF Ceramic Capacitor

C4 : 3.3V&5V - 2200 μF Electrolytic Capacitor

12V&15V - 470 μF Electrolytic Capacitor

24V&28V - 220 μF Electrolytic Capacitor

(ii) $T_p = -40^{\circ}\text{C} \sim 100^{\circ}\text{C}$

C1 : 33 μF Ceramic Capacitor or equivalent capacitor such as 100V 6.8 μF x 5 pcs

C4 : 2 pieces of the above recommended value

(2) Warm up voltage drift characteristics

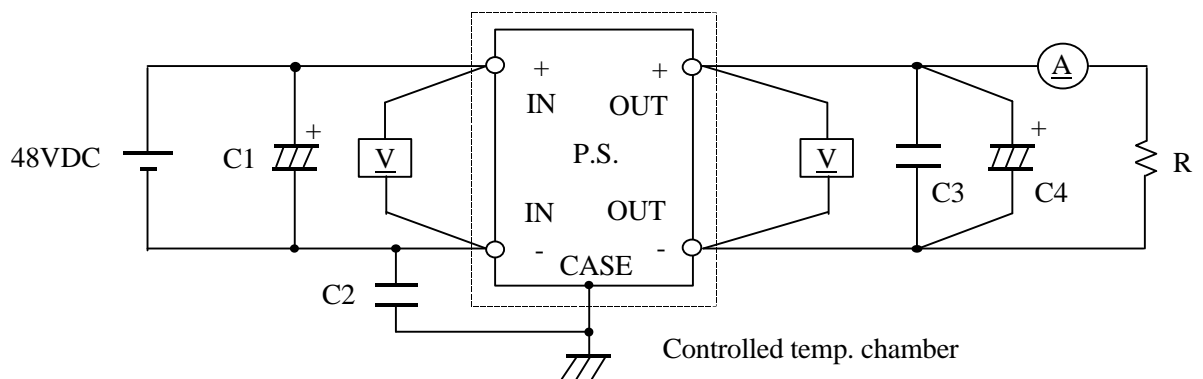

C1 : 33 μF Electrolytic Capacitor

C2 : 4700pF Ceramic Capacitor

C3 : 1 μF Ceramic Capacitor

C4 : 3.3V&5V - 2200 μF Electrolytic Capacitor

12V&15V - 470 μF Electrolytic Capacitor

24V&28V - 220 μF Electrolytic Capacitor

(3) Over current protection (O.C.P.) characteristics

Same as steady state data

(4) Over voltage protection (O.V.P.) characteristics

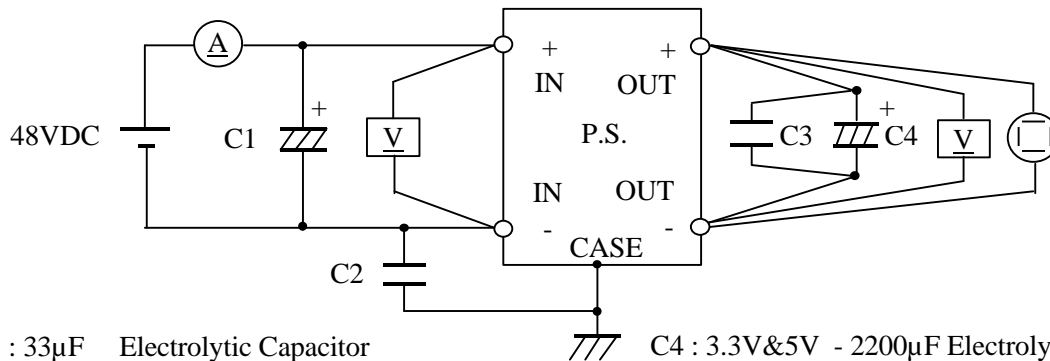

C1 : 33 μ F Electrolytic Capacitor
 C2 : 4700pF Ceramic Capacitor
 C3 : 1 μ F Ceramic Capacitor

C4 : 3.3V&5V - 2200 μ F Electrolytic Capacitor
 12V&15V - 470 μ F Electrolytic Capacitor
 24V&28V - 220 μ F Electrolytic Capacitor

(5) Output rise characteristics

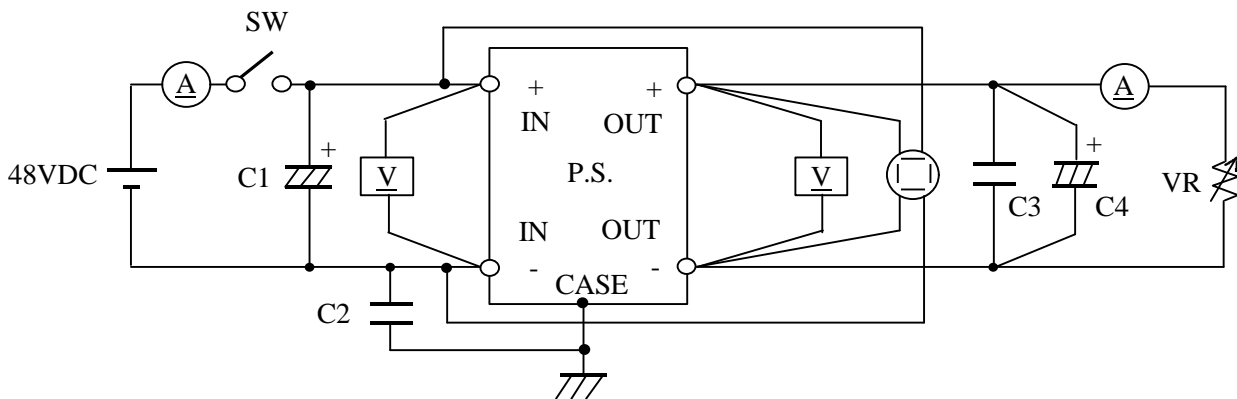

C1 : 33 μ F Electrolytic Capacitor
 C2 : 4700pF Ceramic Capacitor
 C3 : 1 μ F Ceramic Capacitor

C4 : 3.3V&5V - 2200 μ F Electrolytic Capacitor
 12V&15V - 470 μ F Electrolytic Capacitor
 24V&28V - 220 μ F Electrolytic Capacitor

(6) Output fall characteristics

Same as Output rise characteristics

(7) Output rise characteristics with on/off control

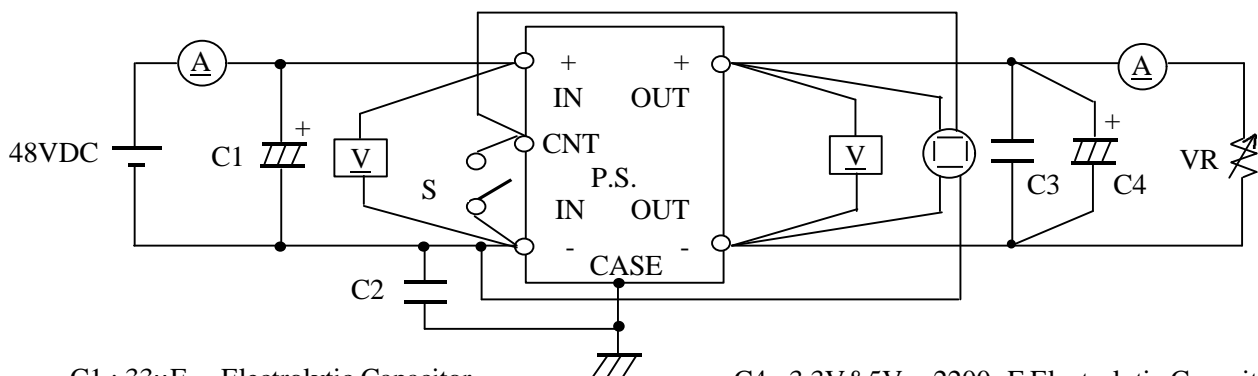

C1 : 33 μ F Electrolytic Capacitor
 C2 : 4700pF Ceramic Capacitor
 C3 : 1 μ F Ceramic Capacitor

C4 : 3.3V&5V - 2200 μ F Electrolytic Capacitor
 12V&15V - 470 μ F Electrolytic Capacitor
 24V&28V - 220 μ F Electrolytic Capacitor

(8) Output fall characteristics with on/off control
 Same as Output rise characteristics with on/off control

(9) Dynamic load response characteristics

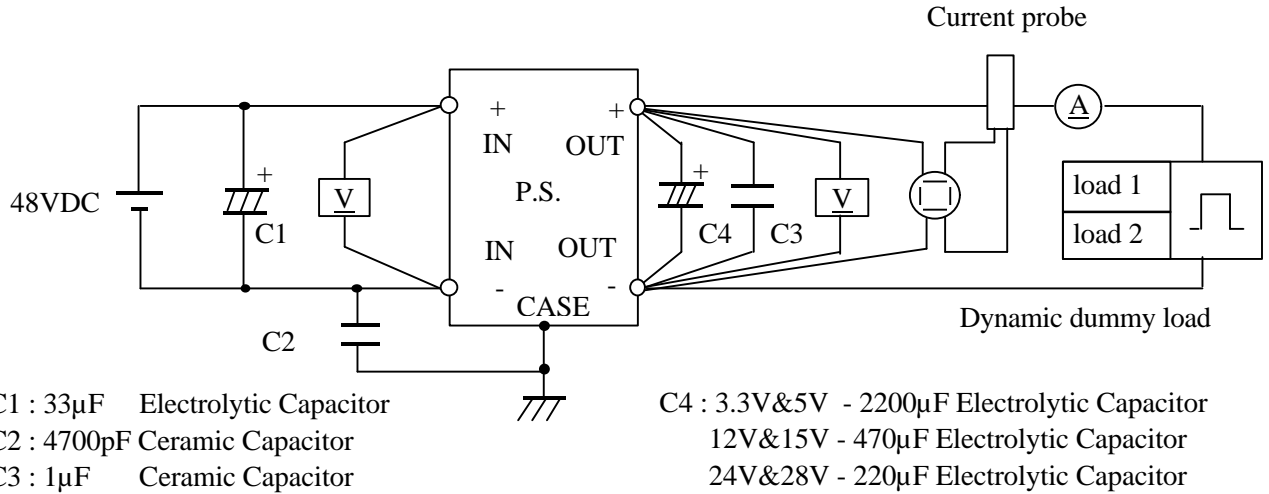

(10) Inrush current waveform

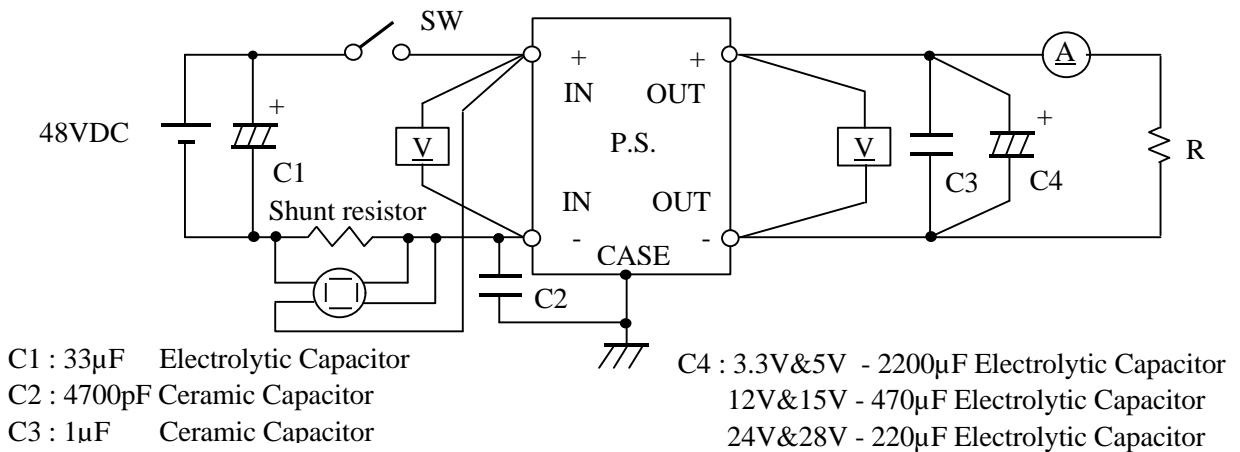

(11) Output-ripple , noise waveform
 NORMAL MODE (EIAJ Standard RC-9002A)

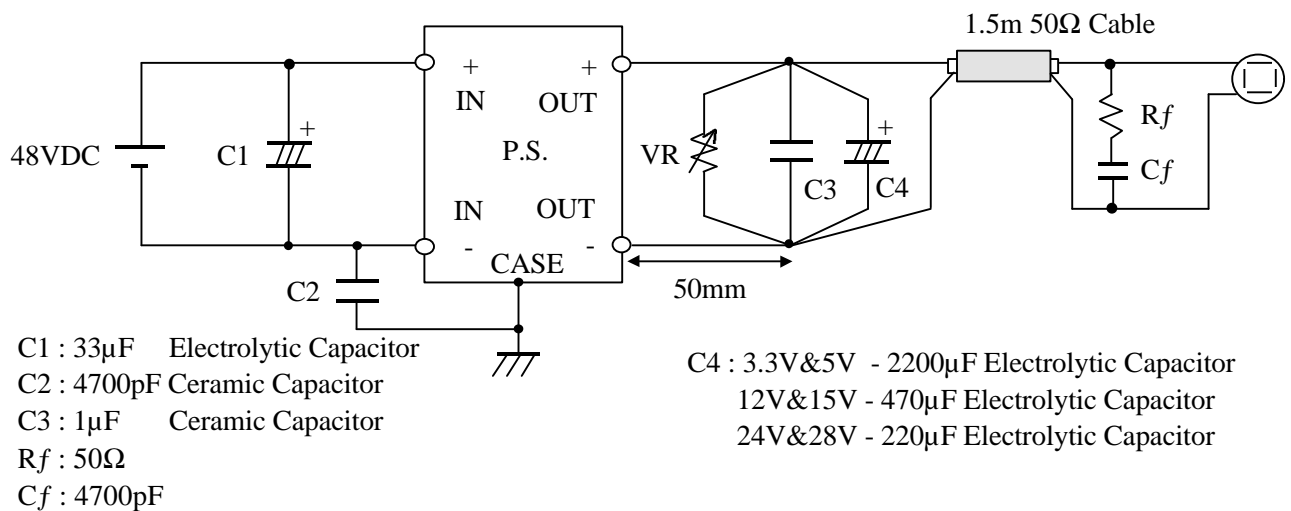

(11) Output-ripple , noise waveform

NORMAL + COMMON MODE

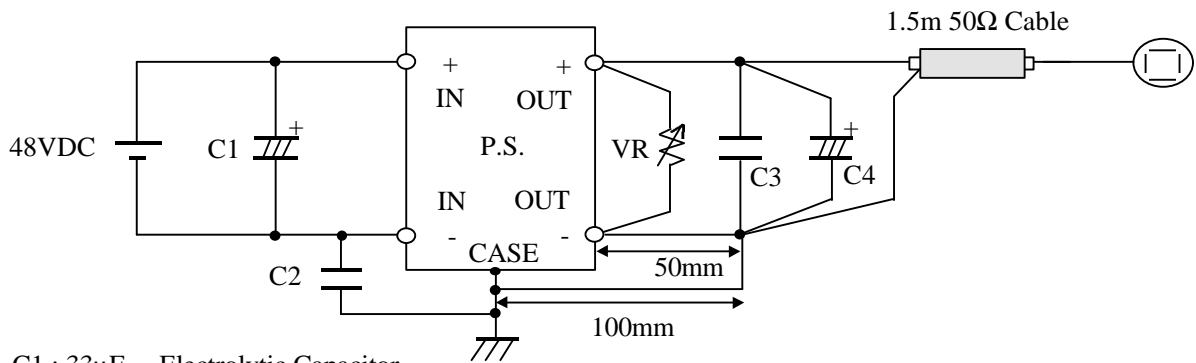

C1 : 33µF Electrolytic Capacitor
 C2 : 4700pF Ceramic Capacitor
 C3 : 1µF Ceramic Capacitor

C4 : 3.3V&5V - 2200µF Electrolytic Capacitor
 12V&15V - 470µF Electrolytic Capacitor
 24V&28V - 220µF Electrolytic Capacitor

(12) Leakage current characteristics

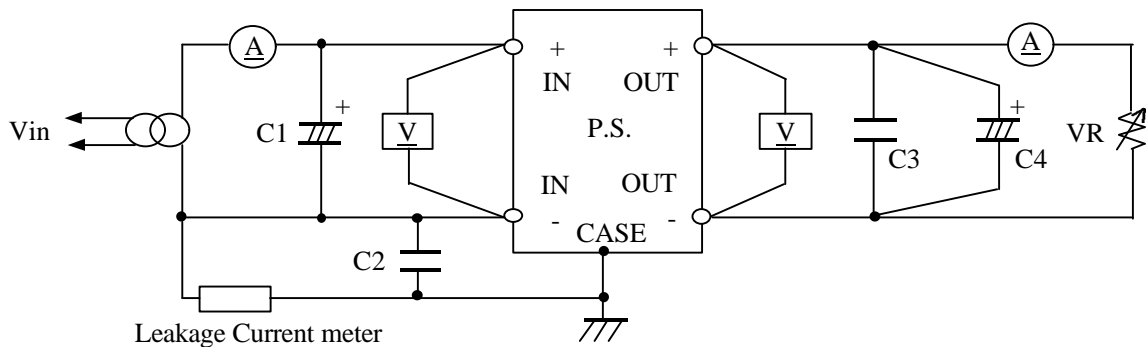

C1 : 33µF Electrolytic Capacitor
 C2 : 4700pF Ceramic Capacitor
 C3 : 1µF Ceramic Capacitor

C4 : 3.3V&5V - 2200µF Electrolytic Capacitor
 12V&15V - 470µF Electrolytic Capacitor
 24V&28V - 220µF Electrolytic Capacitor

(13) Dynamic line characteristics

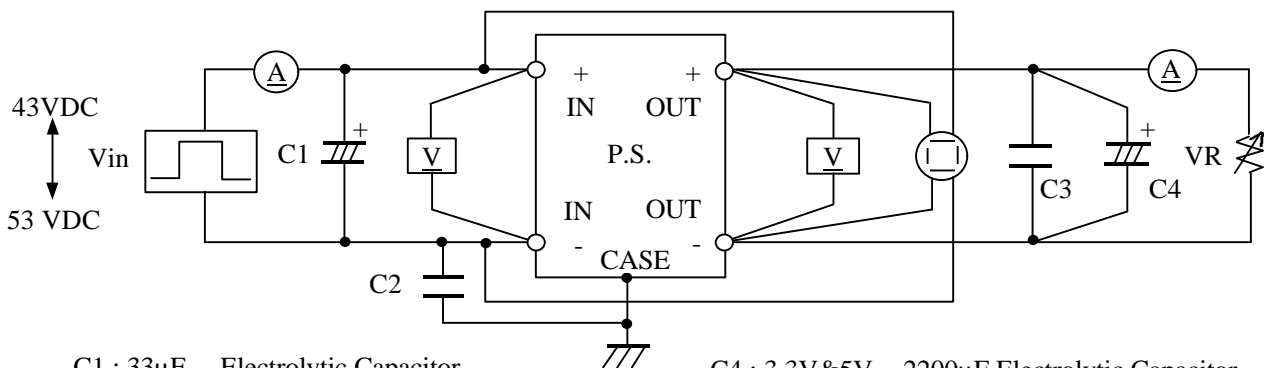

C1 : 33µF Electrolytic Capacitor
 C2 : 4700pF Ceramic Capacitor
 C3 : 1µF Ceramic Capacitor

C4 : 3.3V&5V - 2200µF Electrolytic Capacitor
 12V&15V - 470µF Electrolytic Capacitor
 24V&28V - 220µF Electrolytic Capacitor

(14) AC input response characteristics

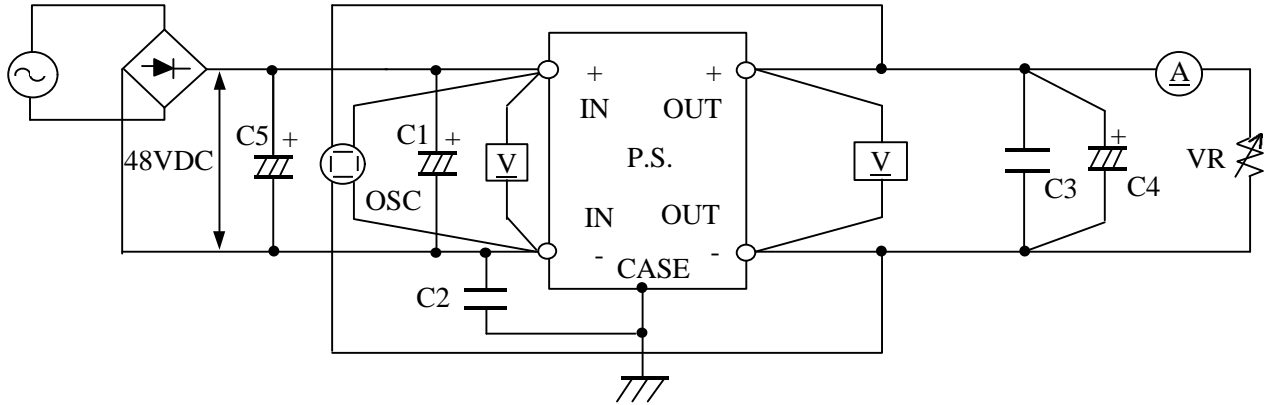

C1 : 33 μ F Electrolytic Capacitor
 C2 : 4700pF Ceramic Capacitor
 C3 : 1 μ F Ceramic Capacitor
 C5 : 560 μ F Electrolytics Capacitor

C4 : 3.3V&5V - 2200 μ F Electrolytic Capacitor
 12V&15V - 470 μ F Electrolytic Capacitor
 24V&28V - 220 μ F Electrolytic Capacitor

(15) Input Reflected current characteristics

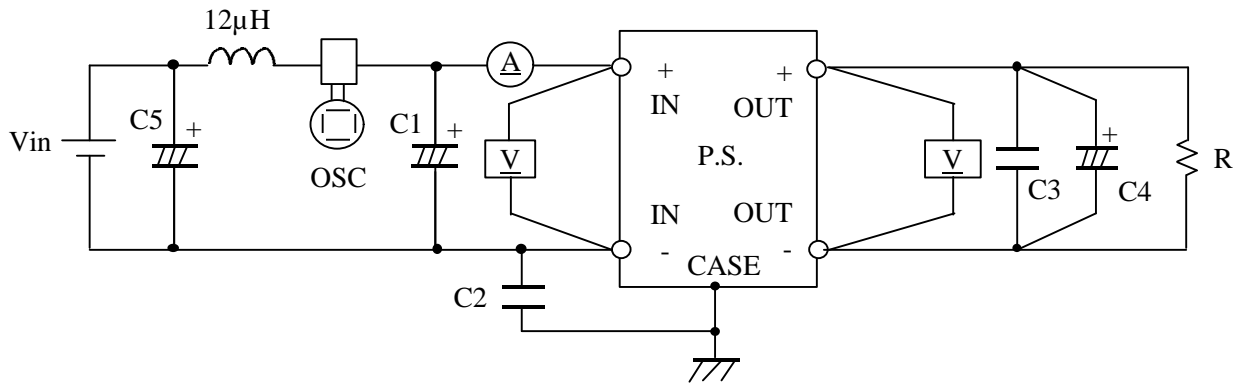

C1 : 33 μ F Electrolytic Capacitor
 C2 : 4700pF Ceramic Capacitor
 C3 : 1 μ F Ceramic Capacitor
 C5 : 220 μ F Elerctrolytic Capacitor

C4 : 3.3V&5V - 2200 μ F Electrolytic Capacitor
 12V&15V - 470 μ F Electrolytic Capacitor
 24V&28V - 220 μ F Electrolytic Capacitor

1-2 List of equipment used

No	Description	Manufacturer	Model No.
1	Oscilloscope	TEKTRONIX	2465B
2		HITACHI	V-1050F
3	Digital oscilloscope	YEW	DL2140
4		HITACHI	VC-6041
5	Digital volt meter	IWATSU	VDAC 7411
6	DC ampere meter	YOKOGAWA ELEC.	2051
7	Dynamic dummy load	TAKAMIZAWA	PSA-150D
8	Variable resistive load	MATSUNAGA	44/11 Ω
9	Variable resistive load	MATSUNAGA	2.4/0.6 Ω
10	Controlled temp . chamber	TABAI	PL-2GM
11	Shunt resistor	KUWANO	100mV , 1A
12	Current probe amplifier	TEKTRONIX	TM503
13	Current probe	TEKTRONIX	A6303
14	AC power source / Analyzer	HEWLETT PACKARD	6813A
15	Leakage current tester	SIMPSON	229-2

2. CHARACTERISTICS

2-1 Steady State Data

(1) Regulation - Line and Load, Temperature Drift

5 V

Regulation - Line and Load Tp = 25°C

Iout \ Vin	36 VDC	48 VDC	76 VDC	Line Regulation	
	0%	5.050V	5.051V	5.051V	1 mV
50%	5.049V	5.050V	5.049V	1 mV	0.020%
100%	5.049V	5.049V	5.049V	0 mV	0.000%
Load Regulation	1 mV	2mV	2mV		
	0.020%	0.040%	0.040%		

Temperature Drift Vin = 48VDC
Iout = 100%

Tp	-40°C	25°C	100°C	Temp. Stability	
Vout	5.034V	5.056V	5.053V	22 mV	0.44%

12 V

Regulation - Line and Load Tp = 25°C

Iout \ Vin	36 VDC	48 VDC	76 VDC	Line Regulation	
	0%	12.022V	12.018V	12.017V	5 mV
50%	12.024V	12.024V	12.023V	1 mV	0.008%
100%	12.025V	12.024V	12.023V	2 mV	0.017%
Load Regulation	3 mV	6 mV	6 mV		
	0.025%	0.050%	0.050%		

Temperature Drift Vin = 48VDC
Iout = 100%

Tp	-40°C	25°C	100°C	Temp. Stability	
Vout	11.995V	12.030V	12.004V	35 mV	0.29%

24 V

Regulation - Line and Load Tp = 25°C

Iout \ Vin	36 VDC	48 VDC	76 VDC	Line Regulation	
	0%	24.009V	24.007V	24.004V	5 mV
50%	24.011V	24.011V	24.009V	2 mV	0.008%
100%	24.013V	24.011V	24.010V	3 mV	0.012%
Load Regulation	4 mV	4 mV	6 mV		
	0.017%	0.017%	0.025%		

Temperature Drift Vin = 48VDC
Iout = 100%

Tp	-40°C	25°C	100°C	Temp. Stability	
Vout	23.958V	24.028V	23.929V	99 mV	0.41%

2. CHARACTERISTICS

2-1 Steady State Data

(2) Output Voltage And Ripple Voltage V.S. Input Voltage

Condition : $I_{out} = 100\%$
 $T_p = -40^\circ\text{C}$ ———
 $T_p = 25^\circ\text{C}$ - - - - -
 $T_p = 100^\circ\text{C}$ ······

5 V

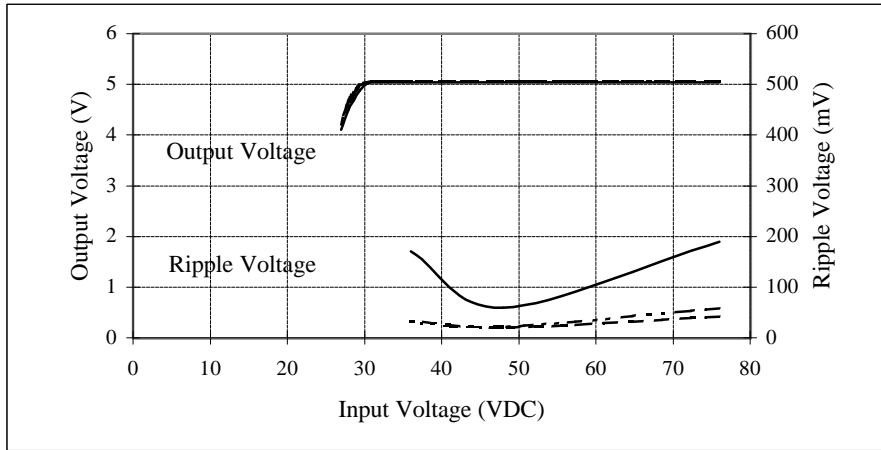

12 V

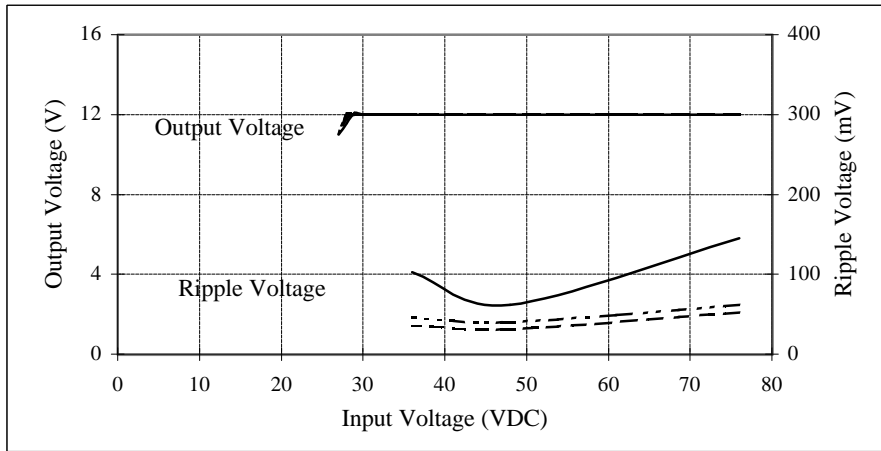

24 V

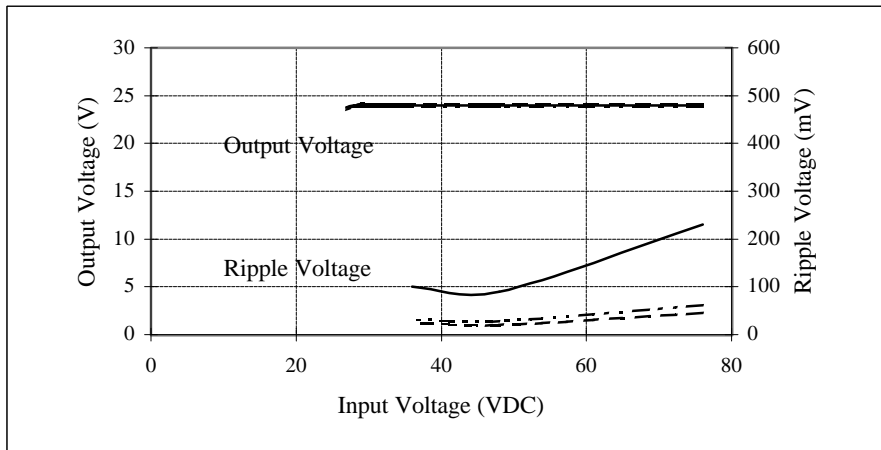

2. CHARACTERISTICS

2-1 Steady State Data

(3) Efficiency And Input Current V.S. Output Current

Condition : $V_{in} = 36\text{ VDC}$ ———
 $= 48\text{ VDC}$ - - - -
 $= 76\text{ VDC}$ - · - · -
 $T_p = 25^\circ\text{C}$

5 V

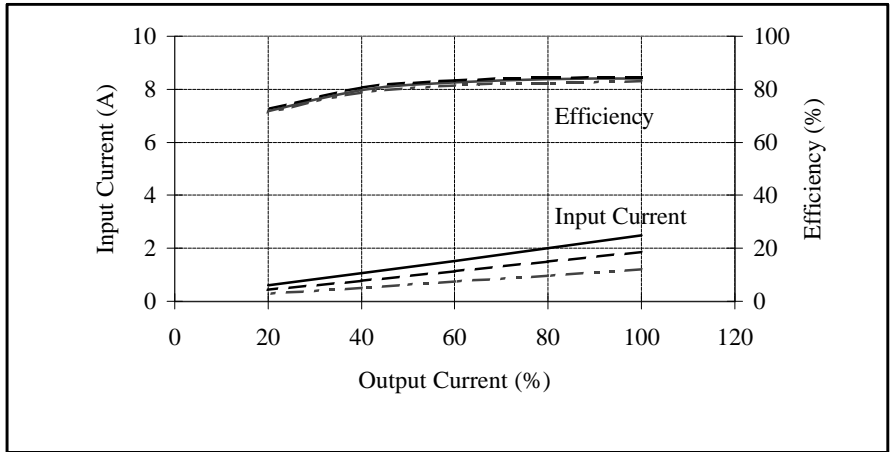

12 V

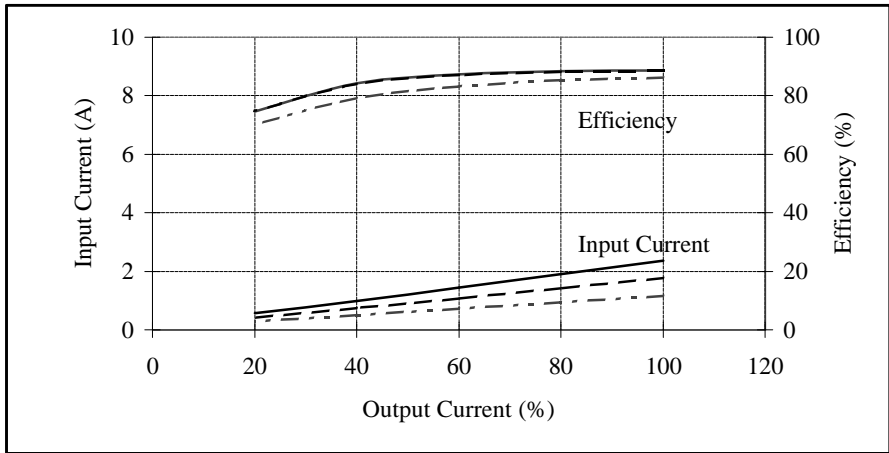

24 V

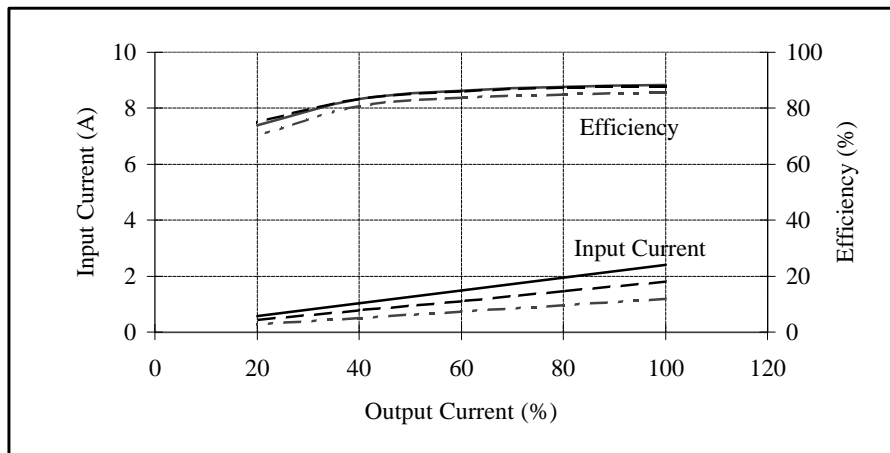

2. CHARACTERISTICS

2-1 Steady State Data

(4) Efficiency v.s. Input Voltage

Condition : Iout = 100%

Tp = 25°C

5 V

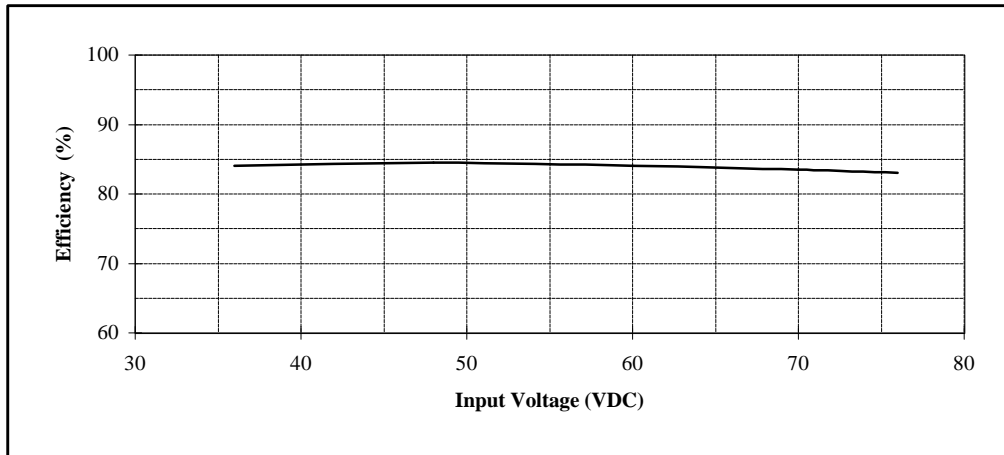

12 V

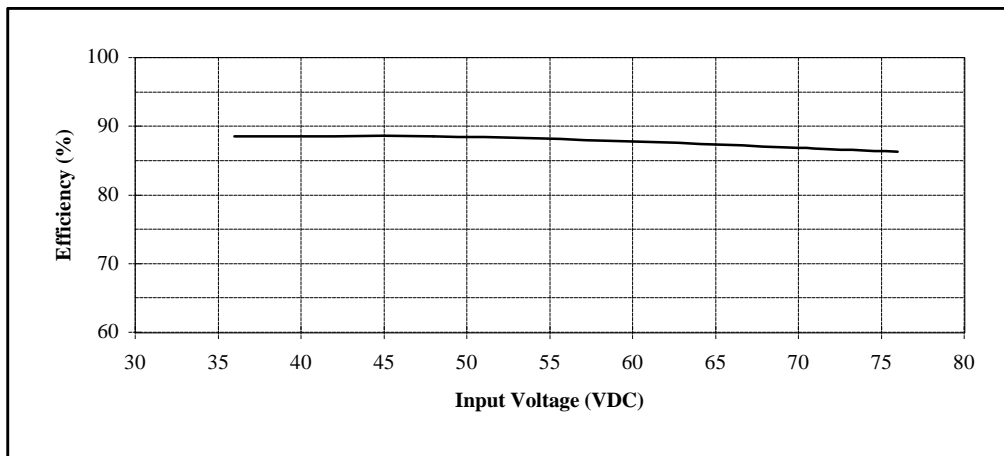

24 V

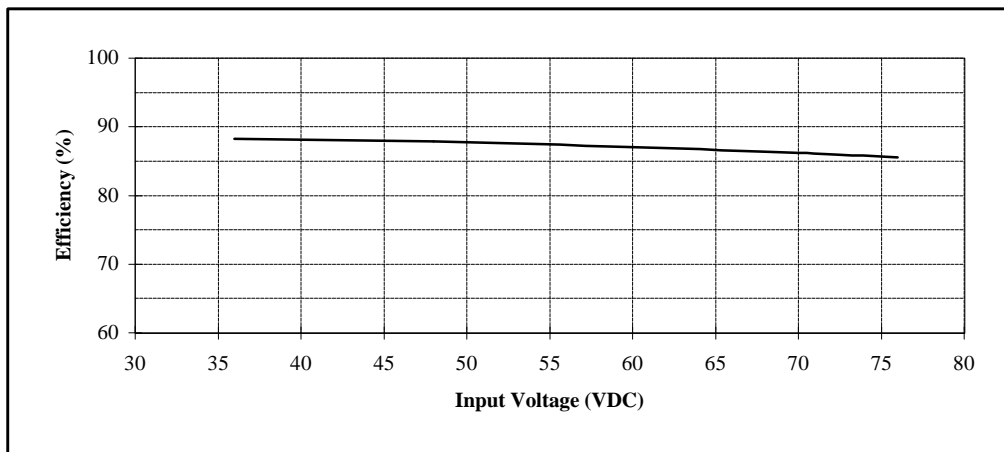

2-2 Warm Up Voltage Drift Characteristics

Condition : $V_{in} = 48 \text{ V DC}$
 $I_{out} = 100 \%$
 $T_p = 25^\circ\text{C}$

5 V

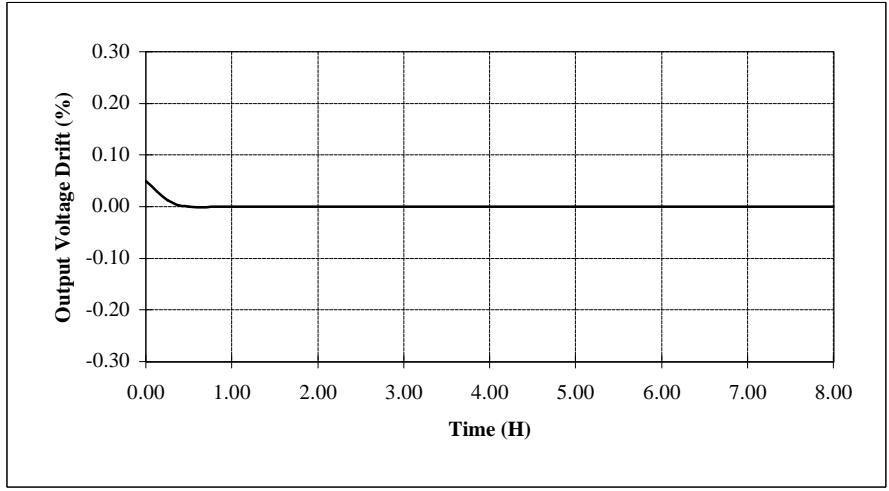

12 V

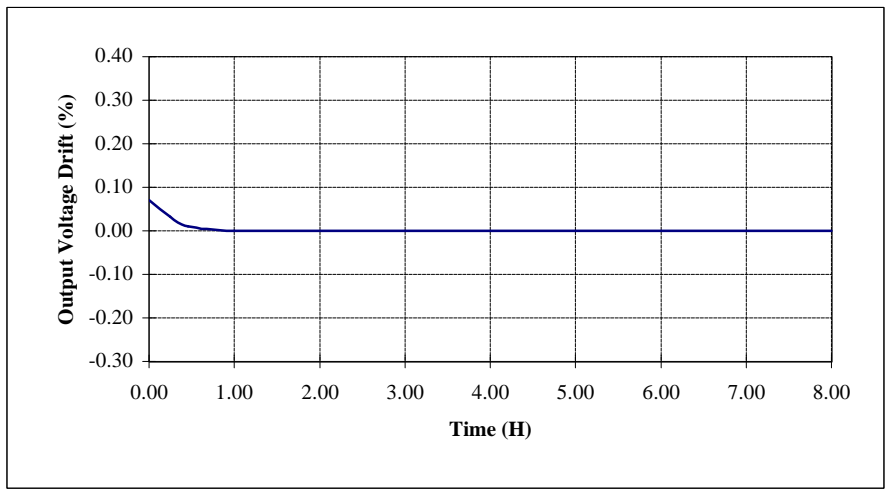

24 V

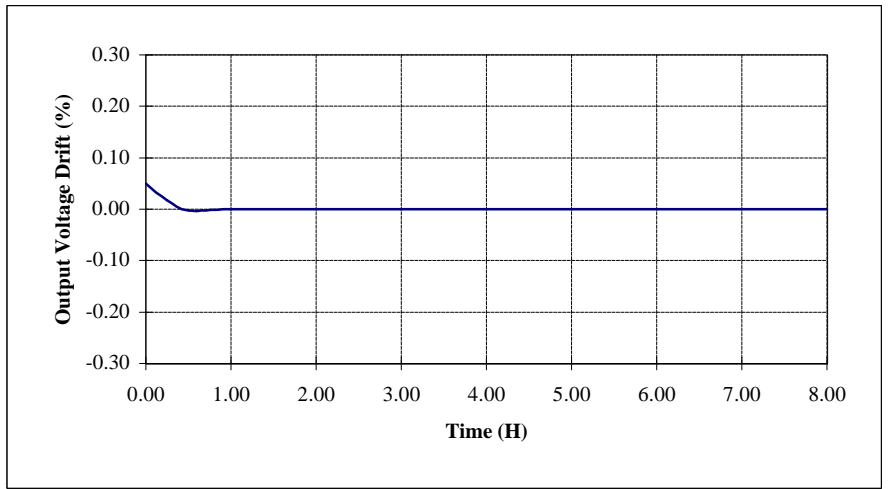

PAH75S48-*

2-3 O.C.P. Charateristics

Condition : $V_{in} = 36 \text{ VDC}$ ———
 $V_{in} = 48 \text{ VDC}$ - - - - -
 $V_{in} = 76 \text{ VDC}$ - · - · -
 $T_p = 25^\circ\text{C}$

5 V

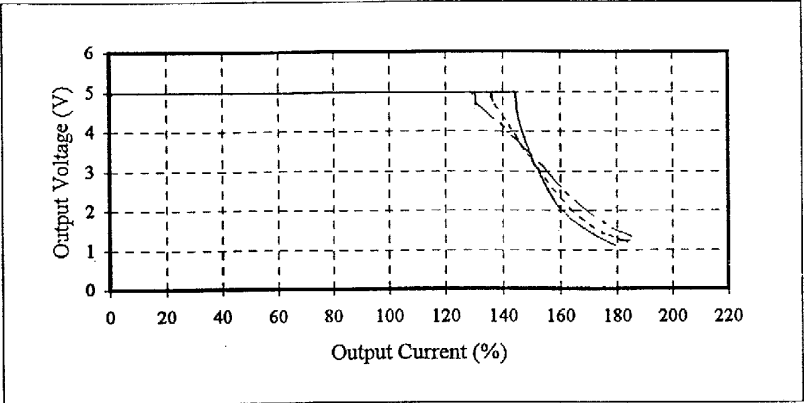

12 V

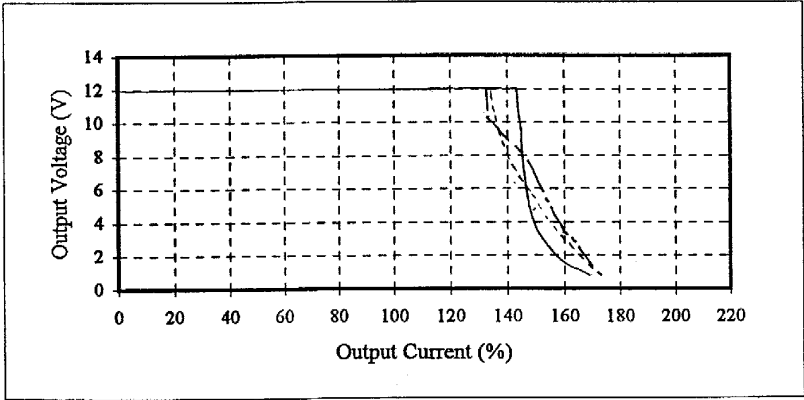

24 V

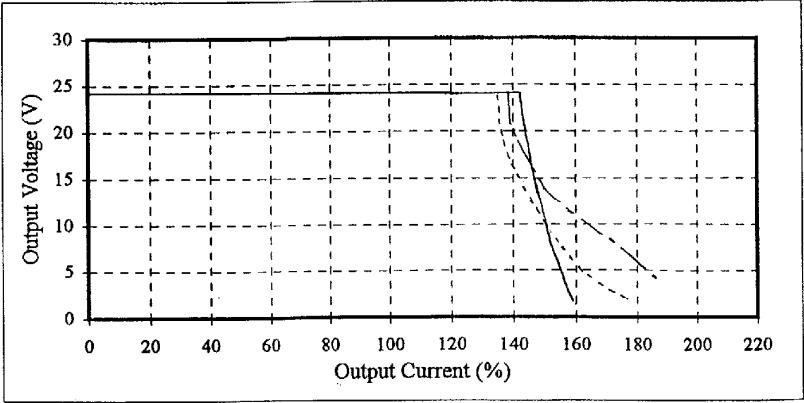

PAH75S48-*

O.C.P. Characteristics

Condition : $T_p = -40^\circ\text{C}$ ———
 $T_p = 25^\circ\text{C}$ - - - - -
 $T_p = 100^\circ\text{C}$ - · - · - ·
 $V_{in} = 48 \text{ VDC}$

5V

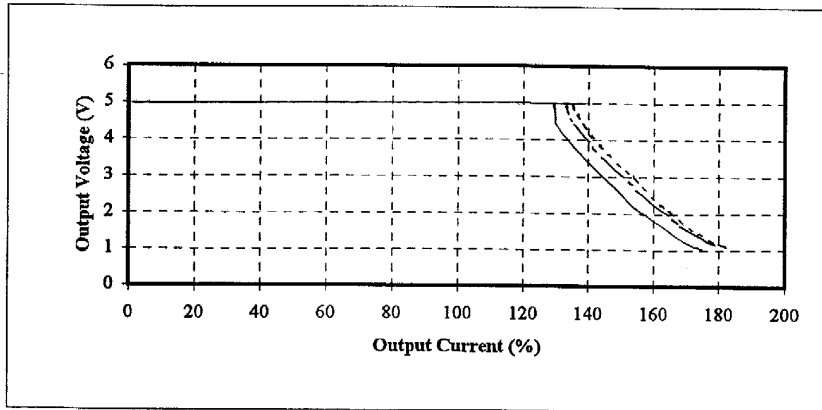

12V

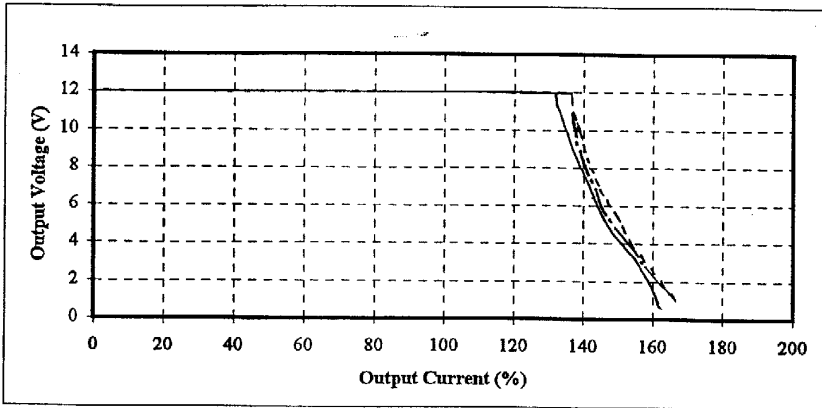

24 V

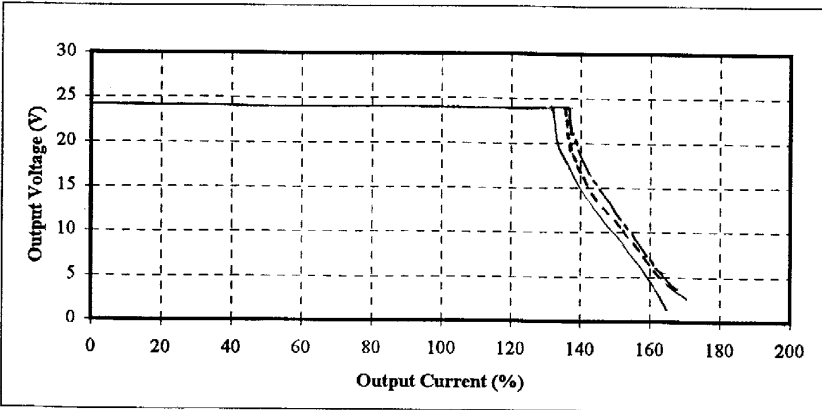

2-4 O.V.P. Characteristics

Condition : $V_{in} = 48 \text{ V DC}$
 $I_{out} = 0 \%$
 $T_p = 25^\circ\text{C}$

5 V

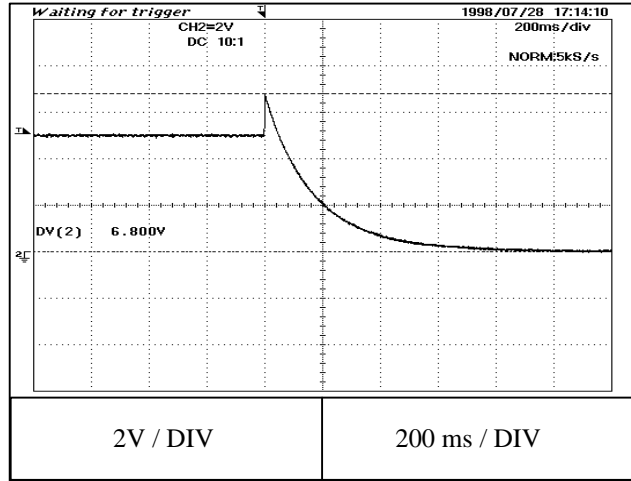

← OVP
Trip Point

12 V

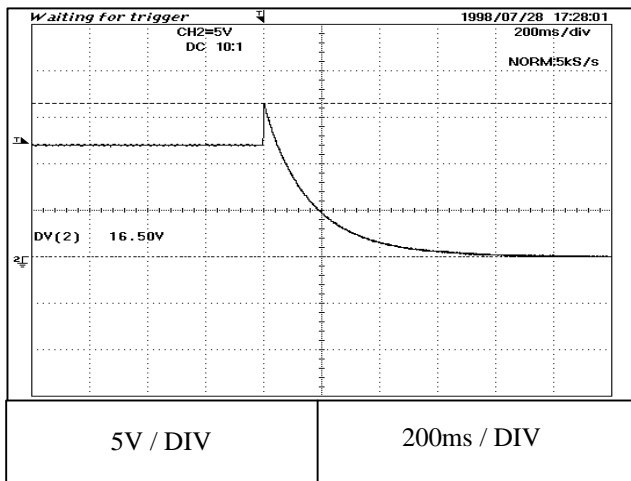

← OVP
Trip Point

24 V

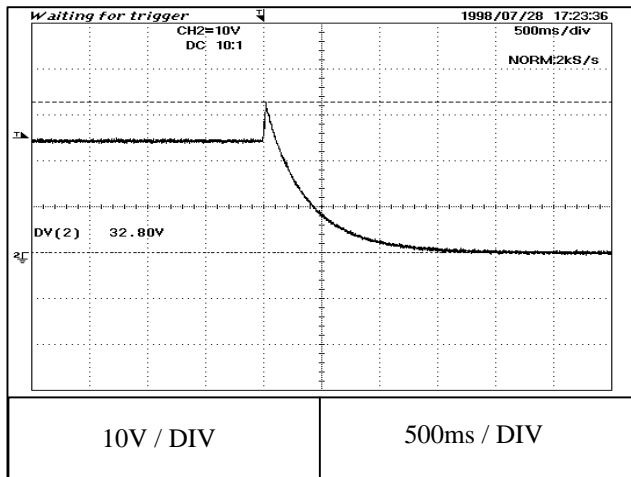

← OVP
Trip Point

2-5 Output Rise Characteristics

Condition : $V_{in} = 48\text{ V DC}$
 $I_{out} = 0\%$
 $T_p = 25^\circ\text{C}$

5 V

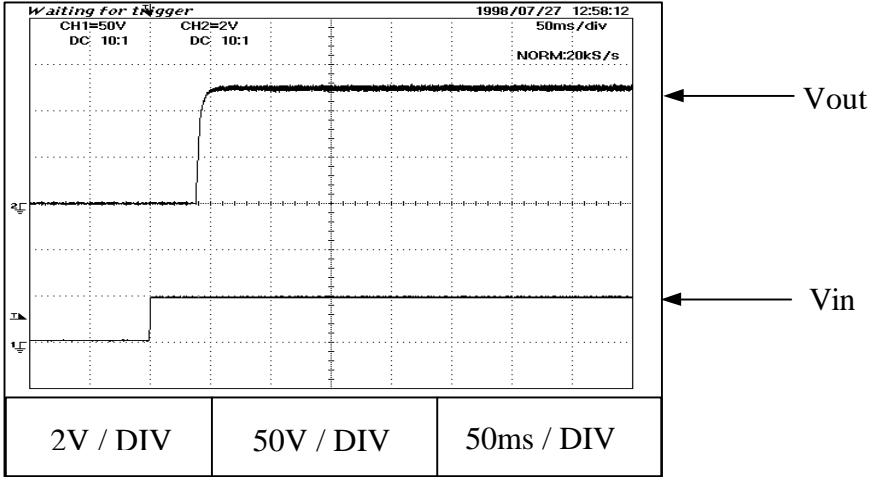

12 V

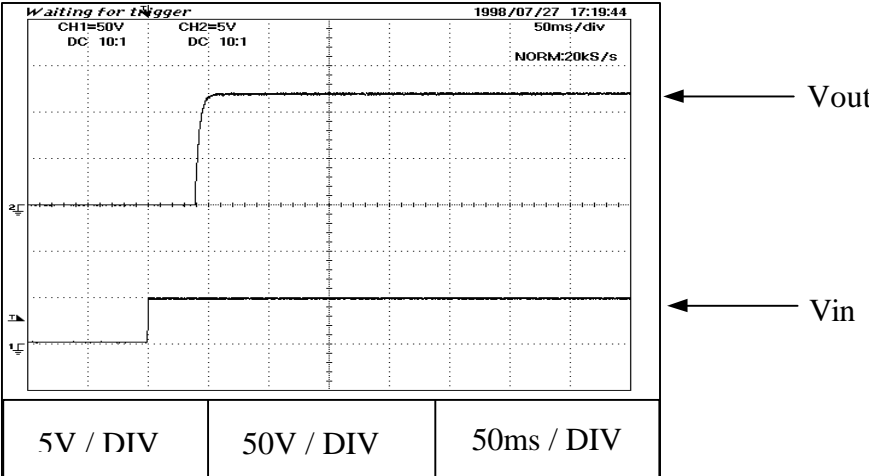

24 V

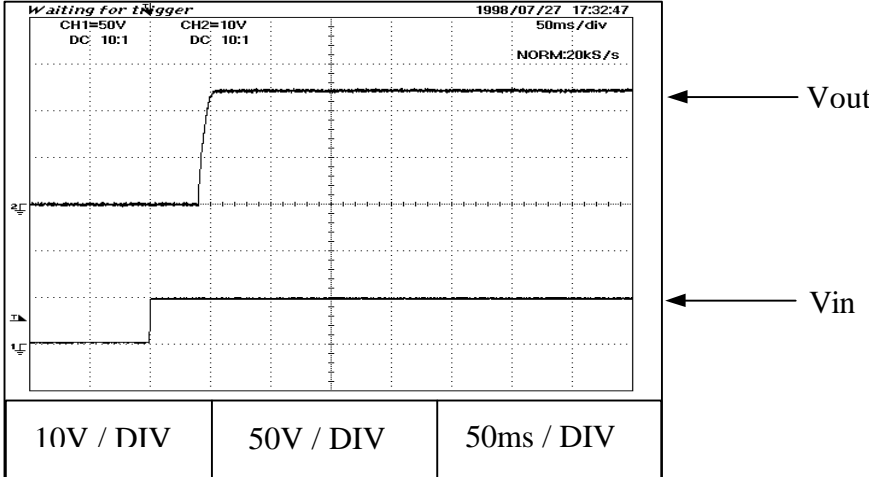

Output Rise Characteristics

Condition : $V_{in} = 48\text{ V DC}$
 $I_{out} = 100\%$
 $T_p = 25^\circ\text{C}$

5 V

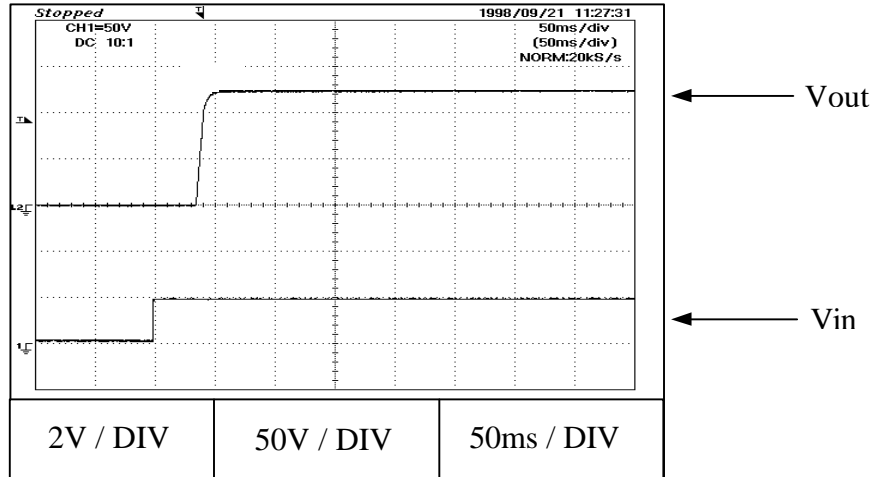

12 V

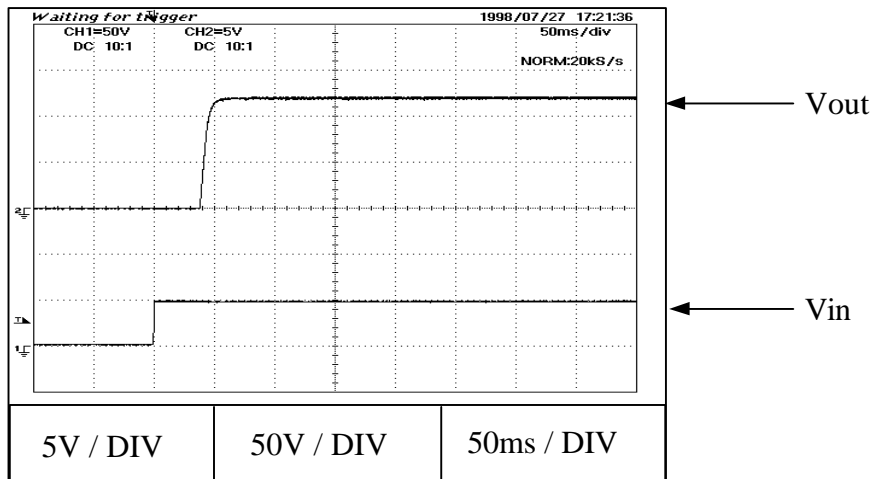

24 V

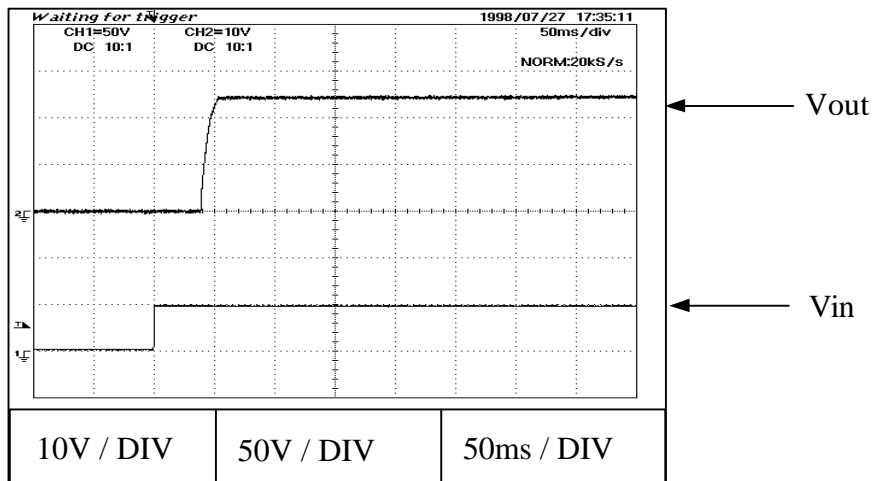

2-6 Output Fall Characteristics

Condition : $V_{in} = 48\text{ V DC}$
 $I_{out} = 0\%$
 $T_p = 25^\circ\text{C}$

5 V

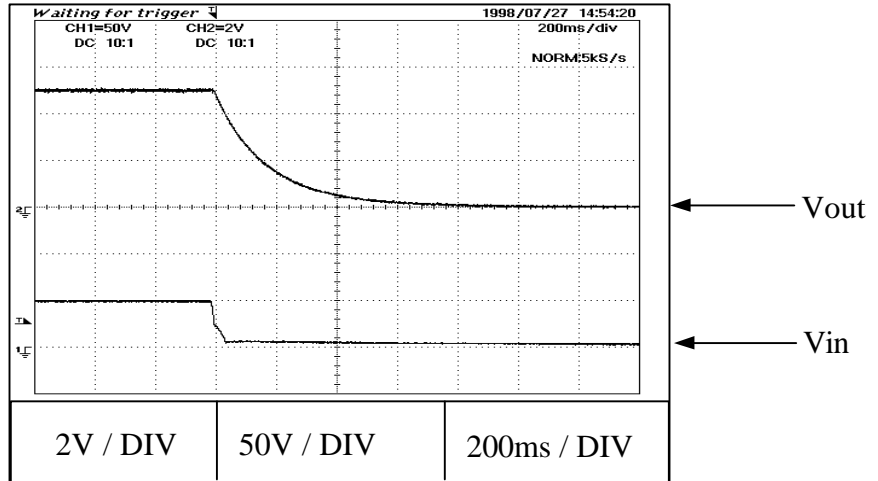

12 V

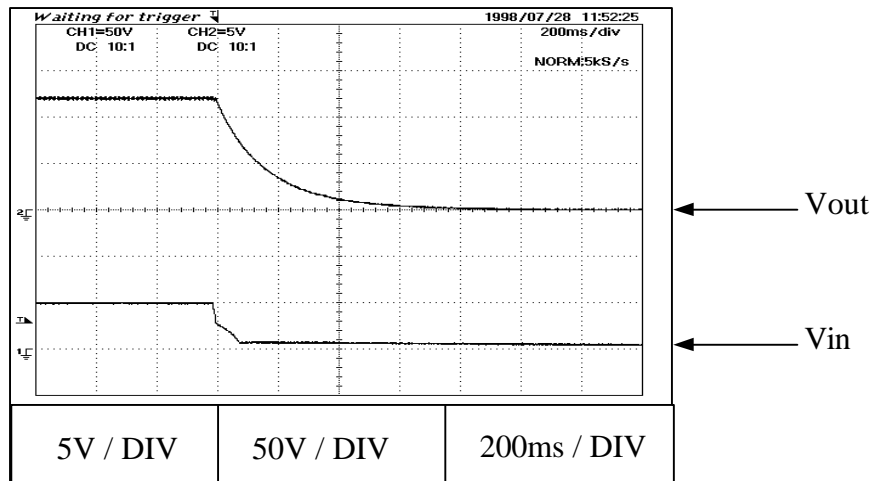

24 V

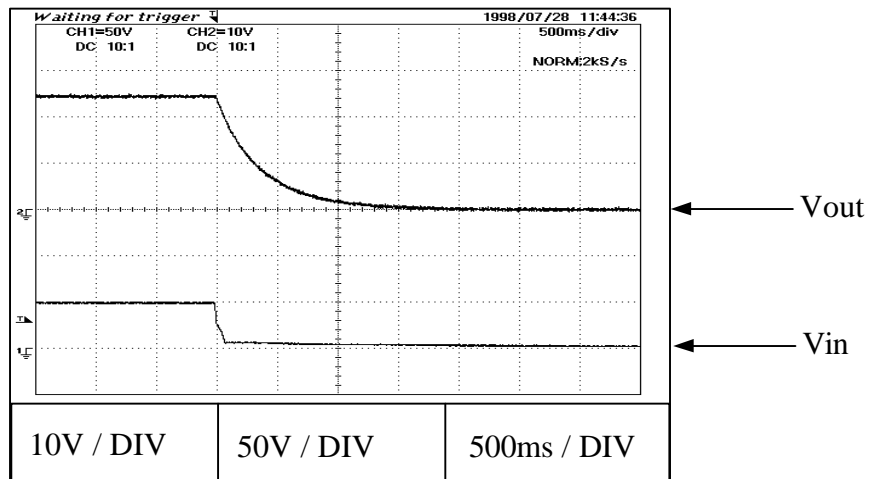

Output Fall Characteristics

Condition : $V_{in} = 48\text{ V DC}$
 $I_{out} = 100\%$
 $T_p = 25^\circ\text{C}$

5 V

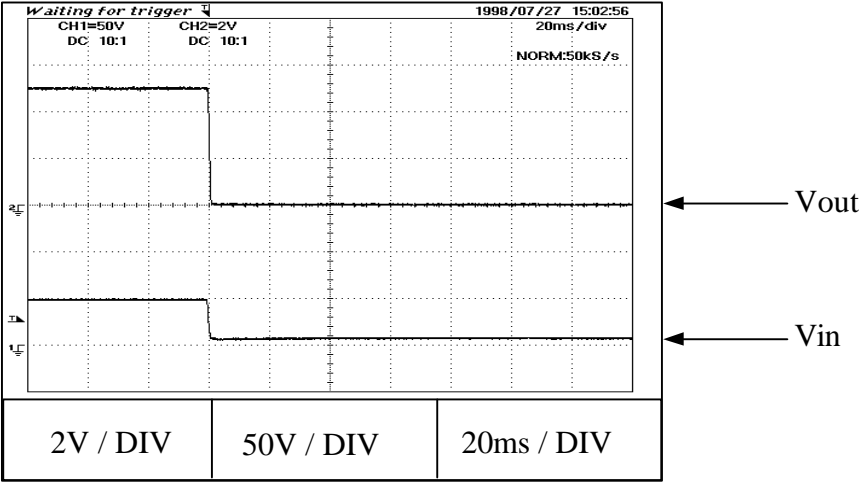

12 V

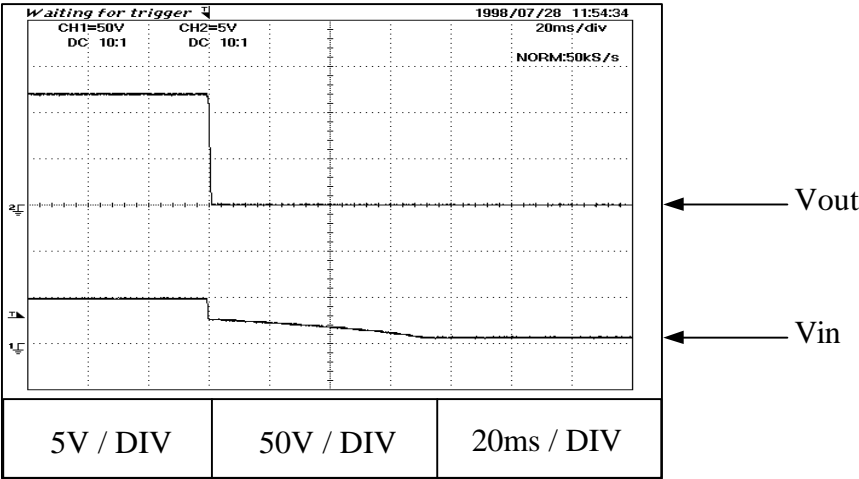

24 V

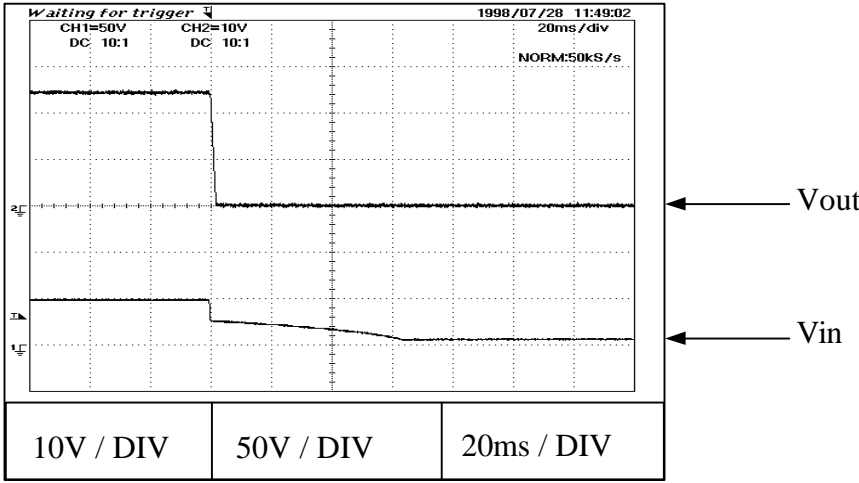

2-7 Output Rise With On/Off Characteristics
(Negative logic)

Condition : $V_{in} = 48 \text{ V DC}$
 $I_{out} = 0 \%$
 $T_p = 25^\circ\text{C}$

5 V

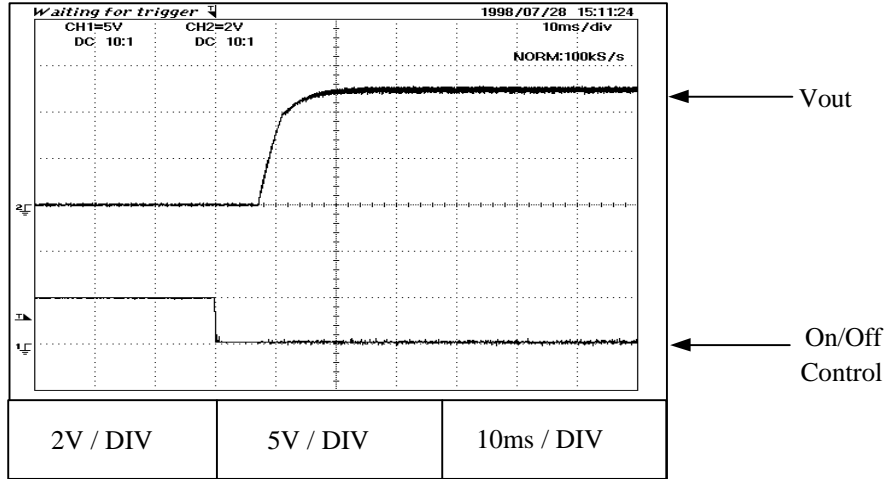

12 V

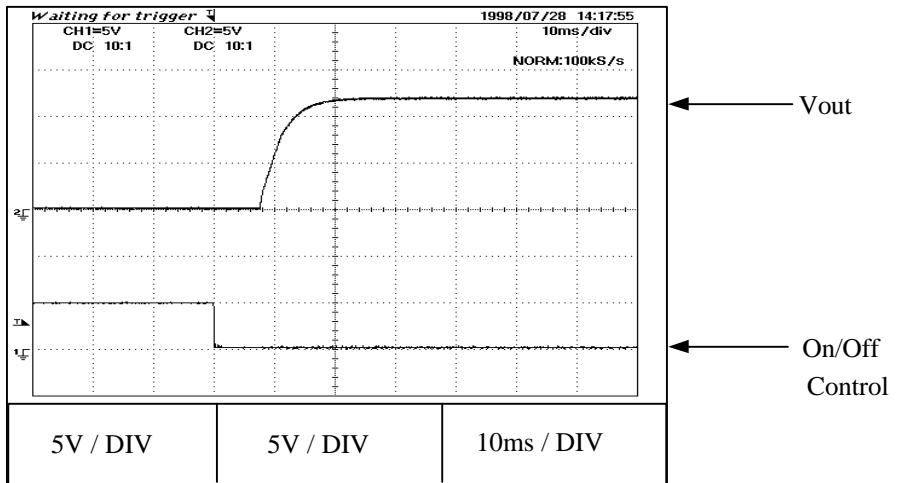

24 V

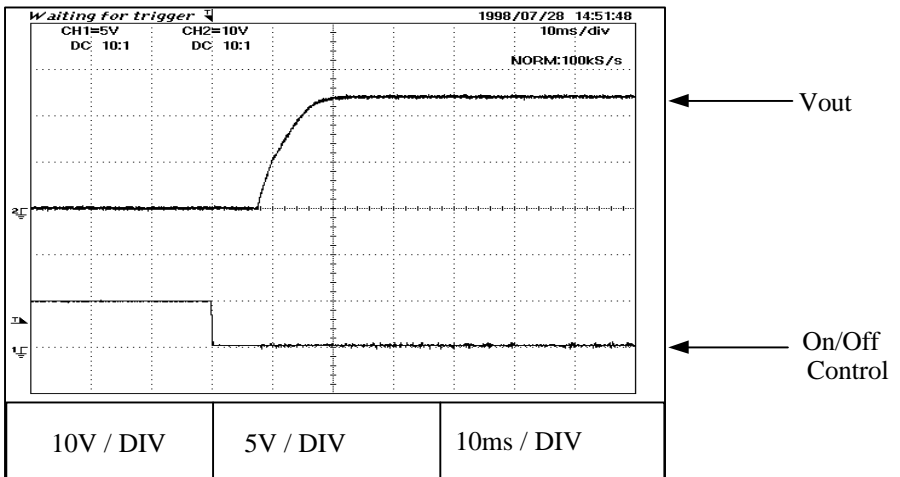

Output Rise With On/Off Characteristics

(Negative logic)

Condition : $V_{in} = 48 \text{ V DC}$
 $I_{out} = 100 \%$
 $T_p = 25^\circ\text{C}$

5 V

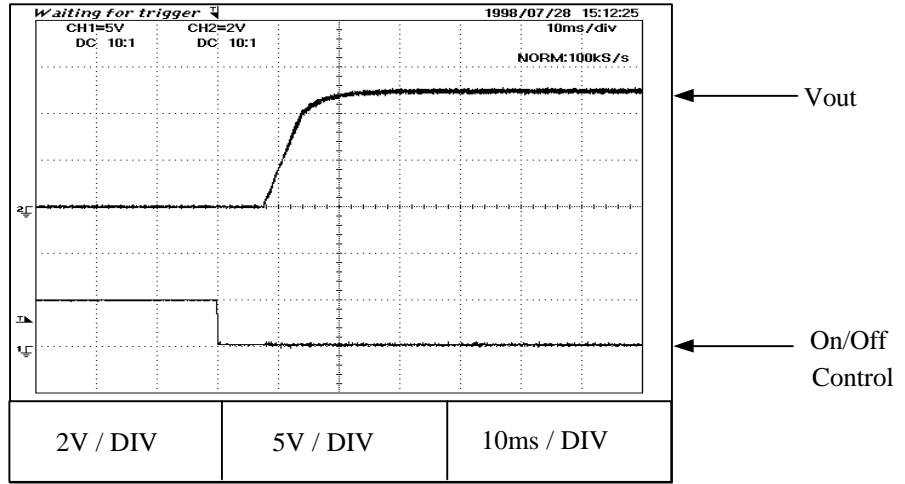

12 V

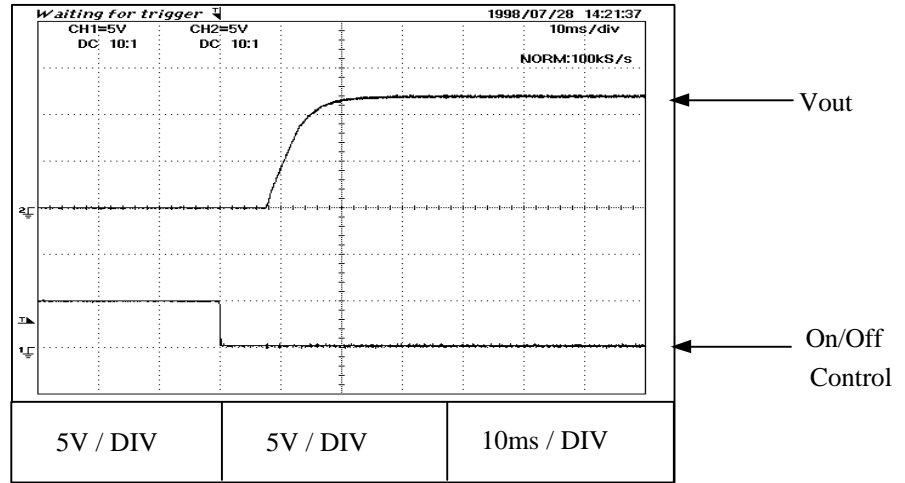

24 V

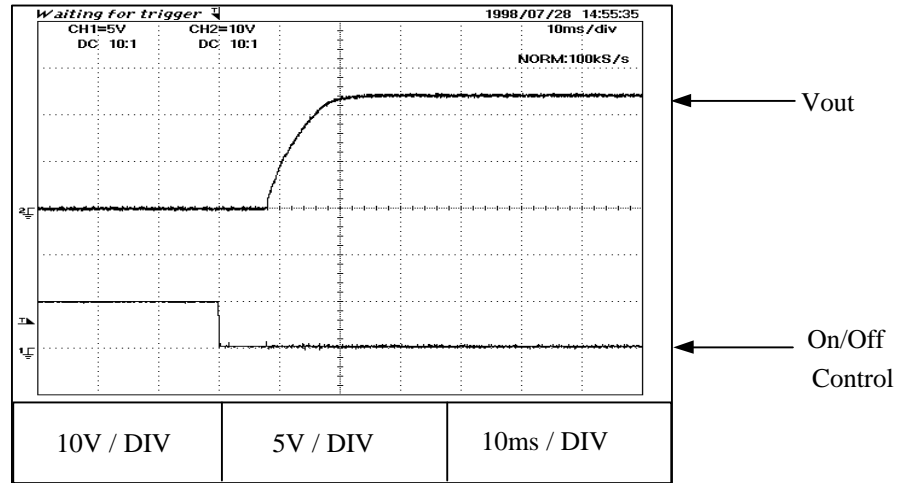

2-8 Output Fall With On/Off Characteristics
(Negative logic)

Condition : $V_{in} = 48 \text{ V DC}$
 $I_{out} = 0 \%$
 $T_p = 25^\circ\text{C}$

5 V

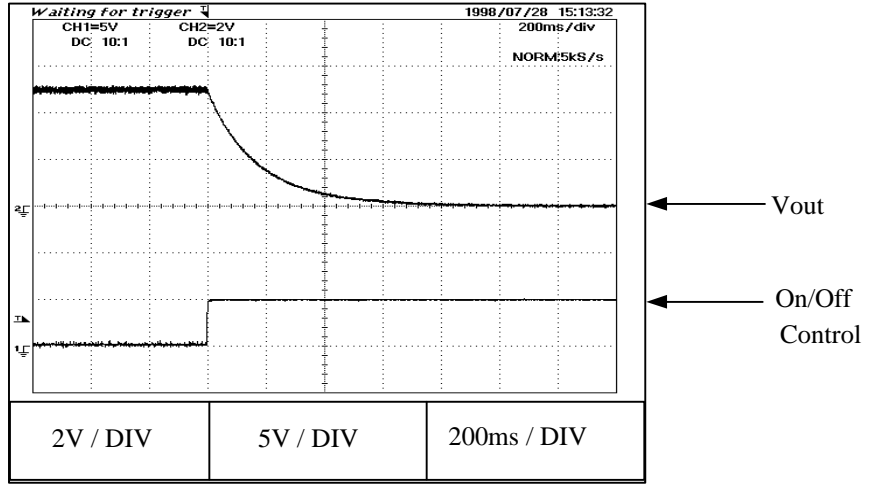

12 V

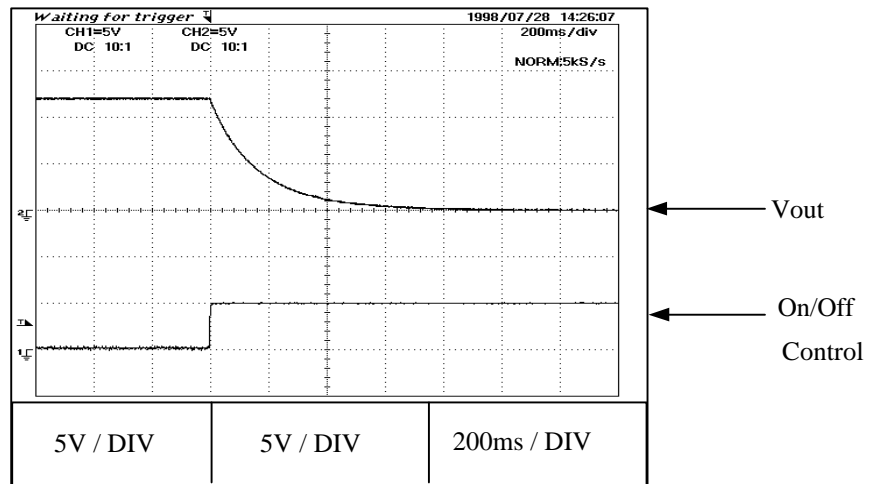

24 V

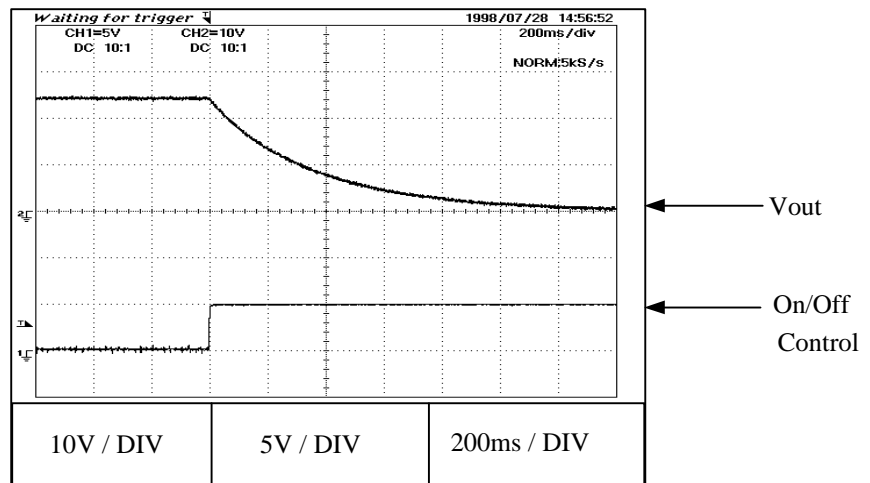

PAH75S48-*

Output Fall With On/Off Characteristics

(Negative logic)

Condition : $V_{in} = 48 \text{ V DC}$
 $I_{out} = 100 \%$
 $T_p = 25^\circ\text{C}$

5 V

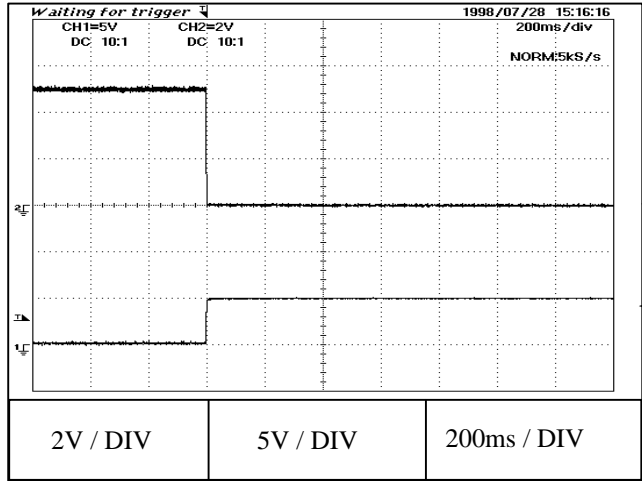

← Vout
 ← On/Off Control

12 V

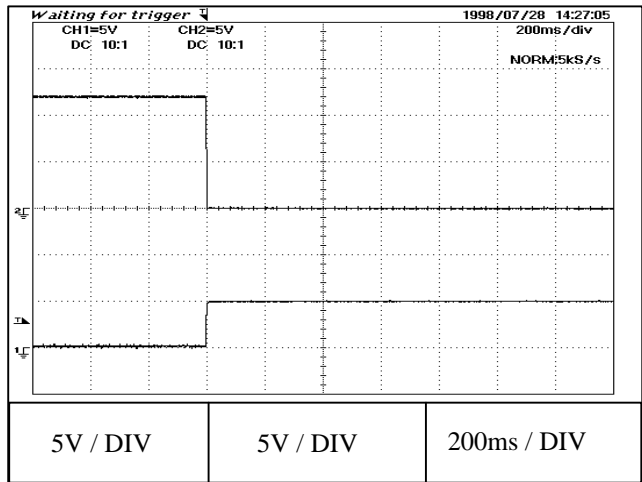

← Vout
 ← On/Off Control

24 V

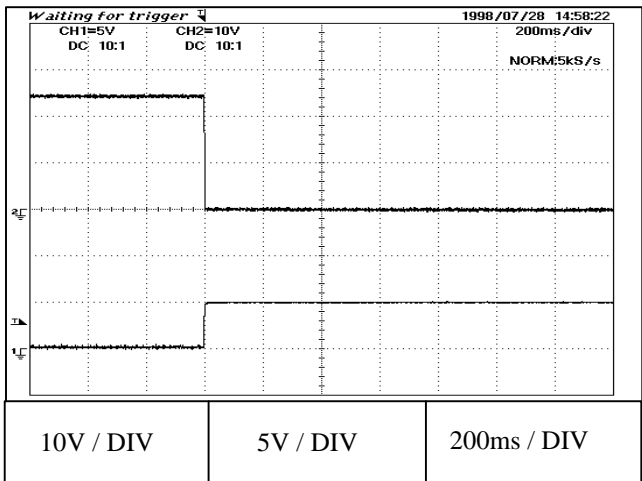

← Vout
 ← On/Off Control

2-9 Dynamic Load Response Characteristics

Condition : $V_{in} = 48 \text{ VDC}$
 $T_p = 25^\circ\text{C}$

5 V

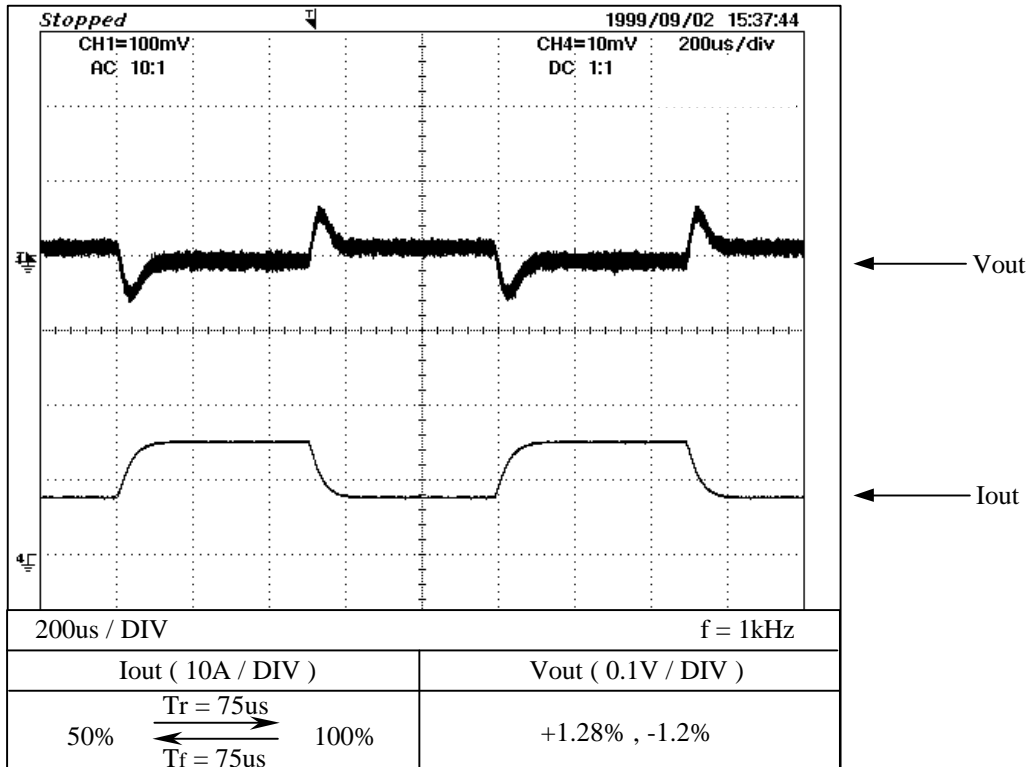
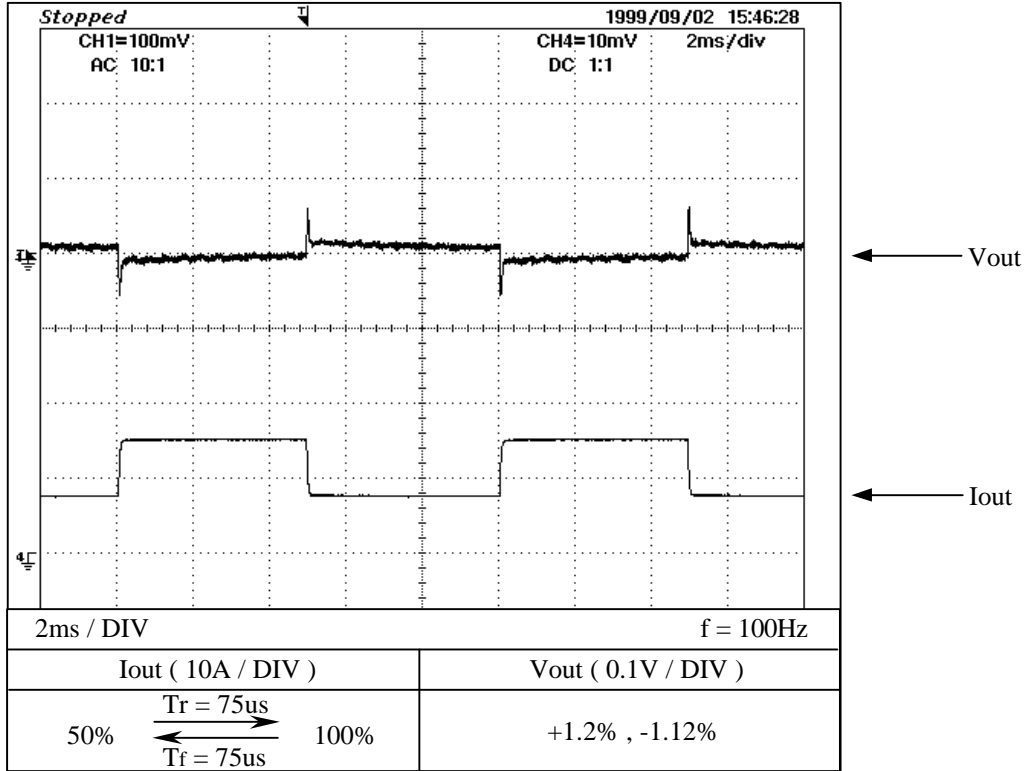

Dynamic Load Response Characteristics

Condition : $V_{in} = 48 \text{ VDC}$
 $T_p = 25^\circ\text{C}$

12 V

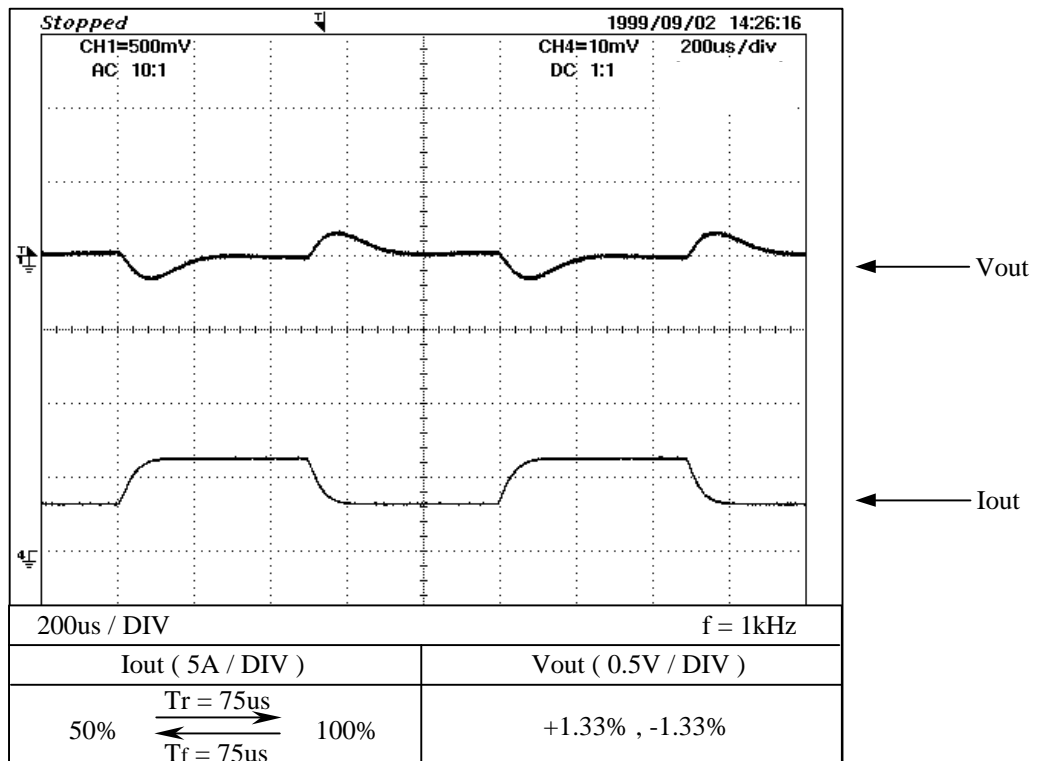
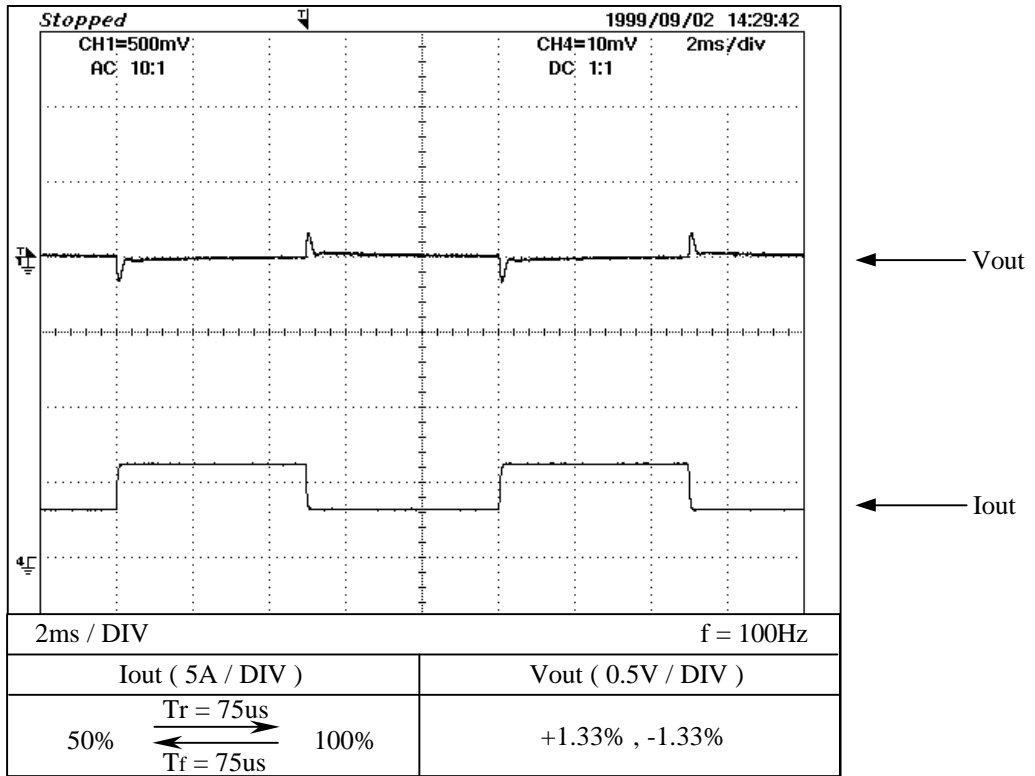

Dynamic Load Response Characteristics

Condition : $V_{in} = 48 \text{ VDC}$
 $T_p = 25^\circ\text{C}$

24 V

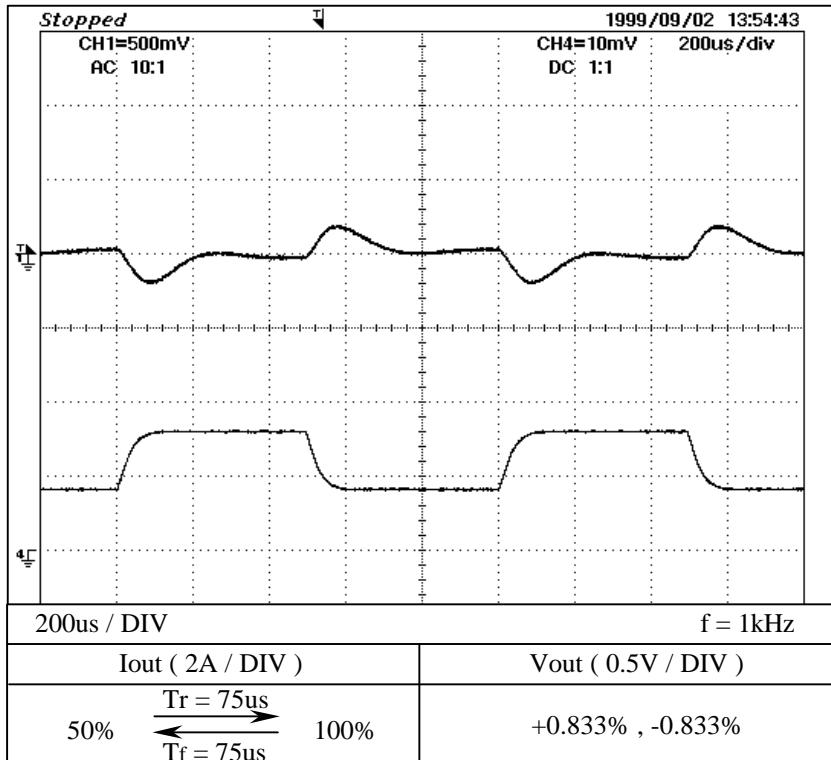
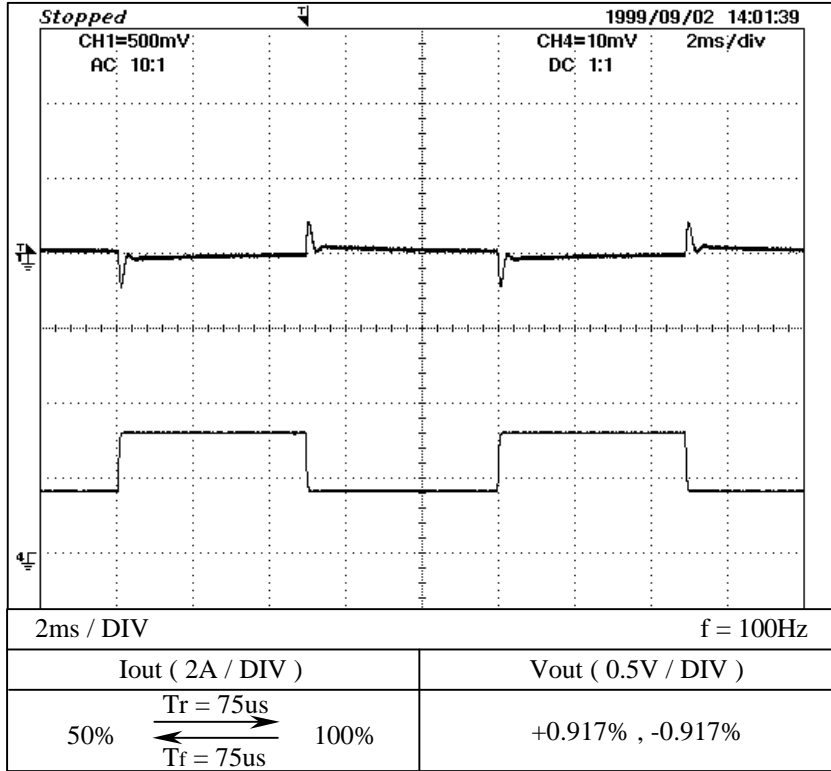

2-10 Inrush Current Waveform

Condition : $V_{in} = 48 \text{ V DC}$
 $I_{out} = 100 \%$
 $T_p = 25^\circ\text{C}$

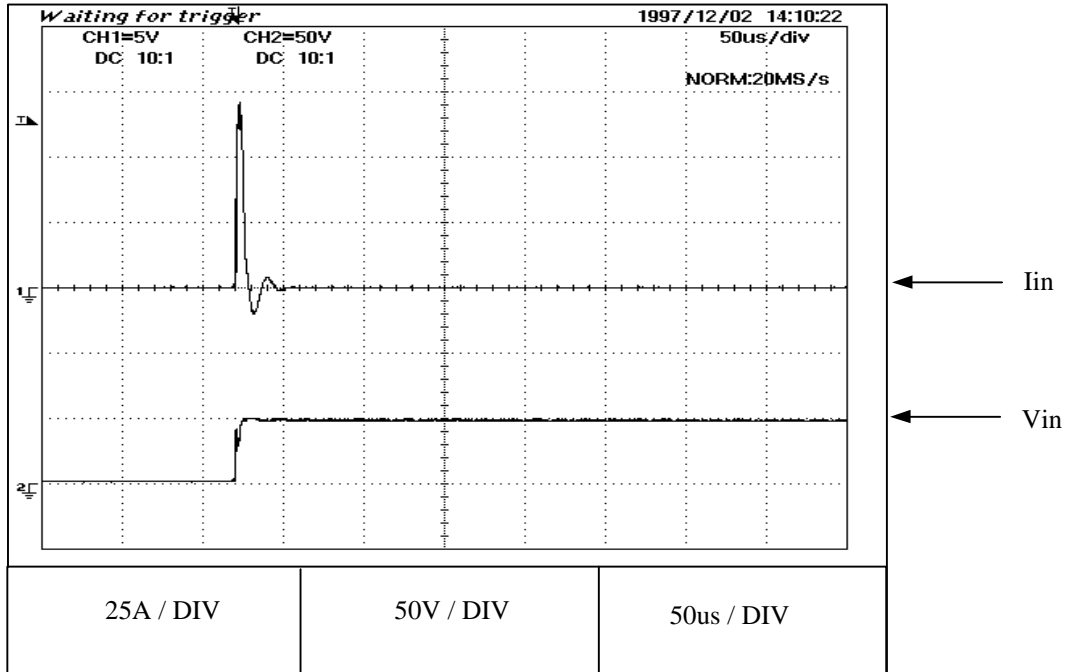

2-11 Output - Ripple & Noise Waveform

Condition : $V_{in} = 48V DC$
 $I_{out} = 100\%$
 $T_p = 25^{\circ}C$

5 V

NORMAL MODE

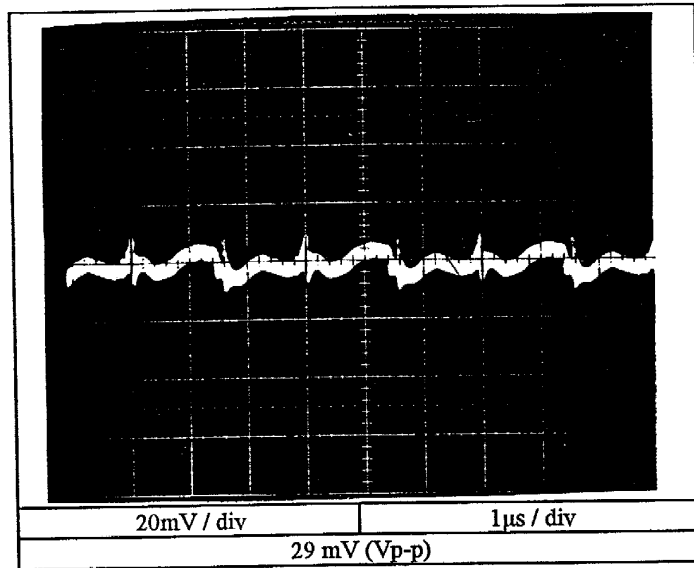

NORMAL + COMMON MODE

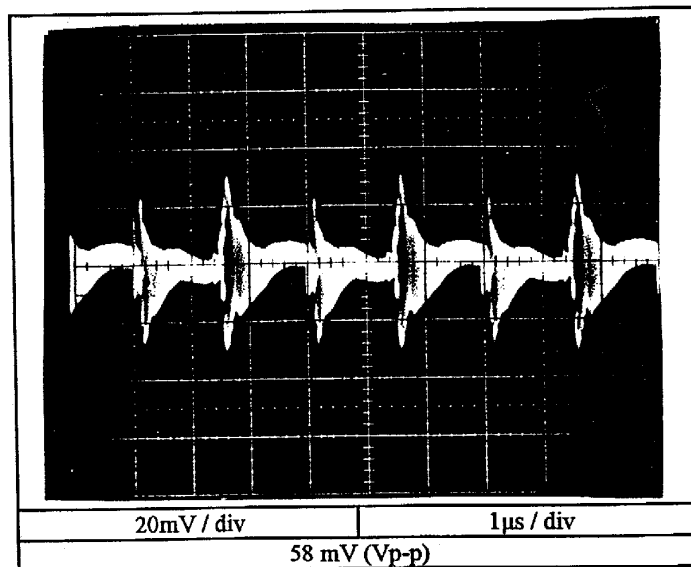

PAH75S48-*

Output - Ripple & Noise Waveform

Condition : $V_{in} = 48V DC$
 $I_{out} = 100\%$
 $T_p = 25^{\circ}C$

12 V

NORMAL MODE

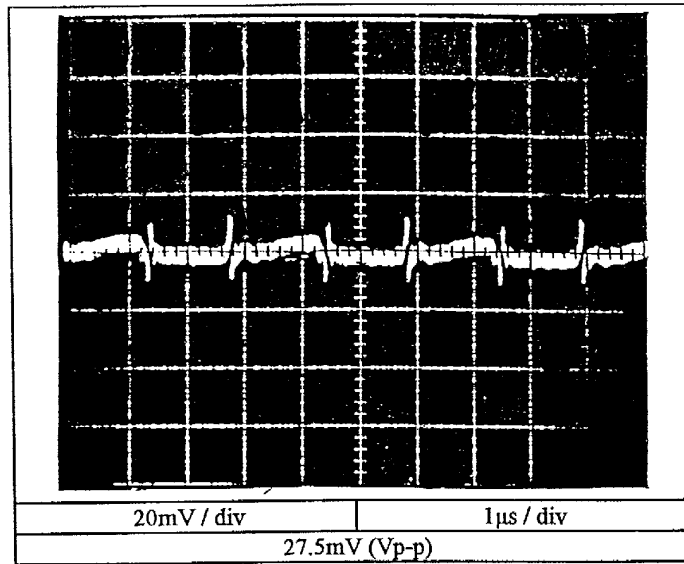

NORMAL + COMMON MODE

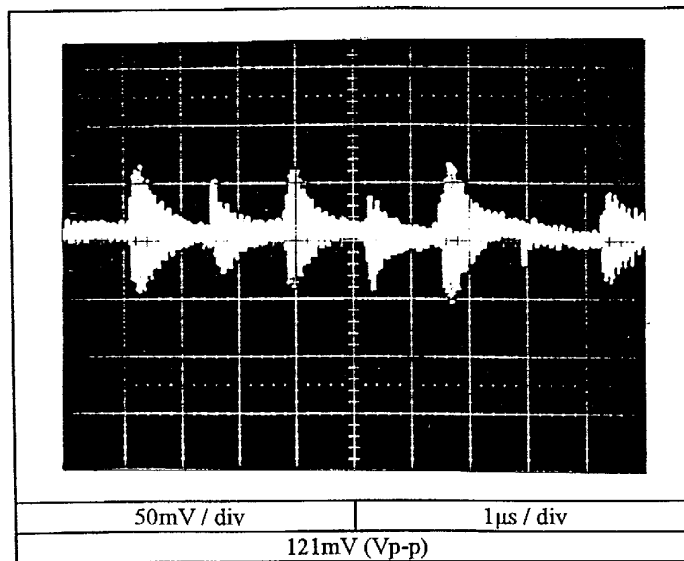

PAH75S48-*

Output - Ripple & Noise Waveform

Condition : $V_{in} = 48V DC$
 $I_{out} = 100\%$
 $T_p = 25^{\circ}C$

24 V

NORMAL MODE

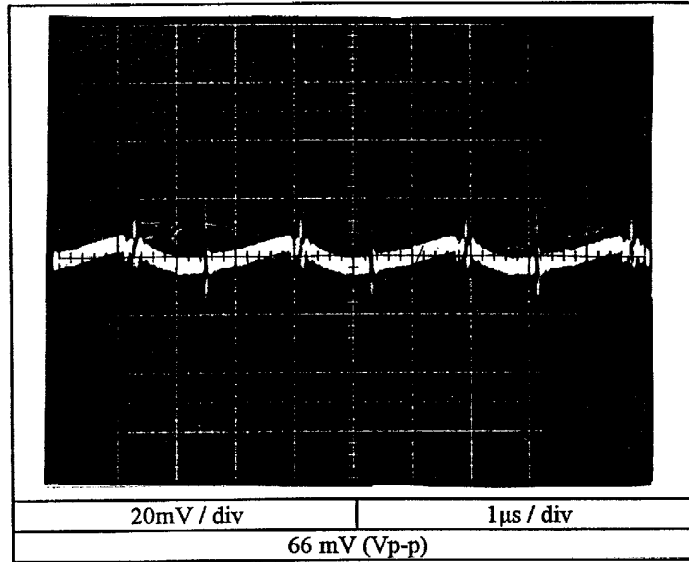

NORMAL + COMMON MODE

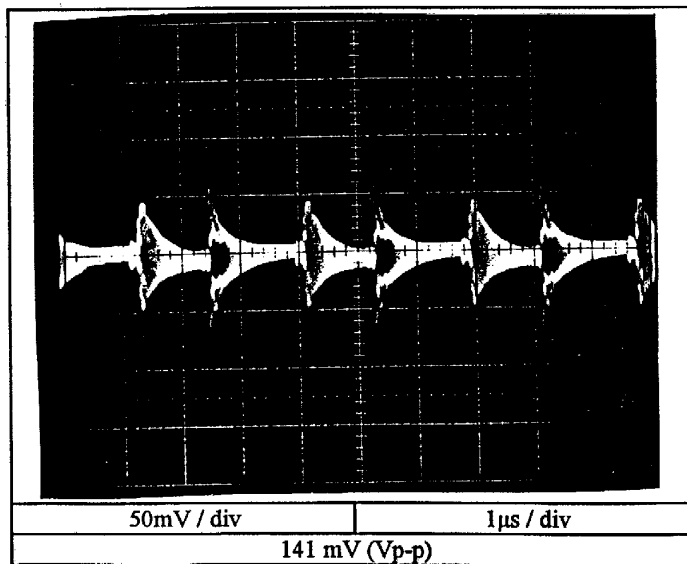

2-12 Leakage Current Characteristics

Condition : Iout = 100%
Tp= 25°C

5V

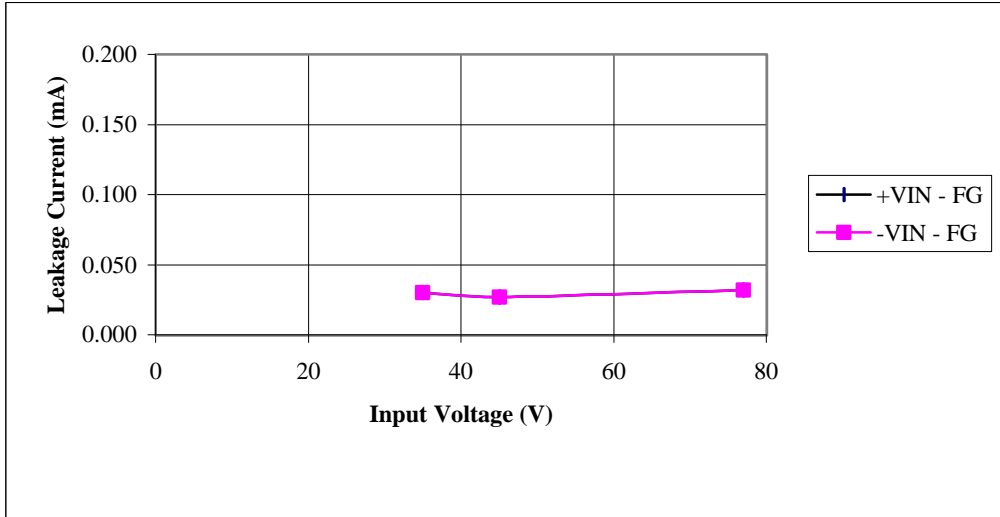

12V

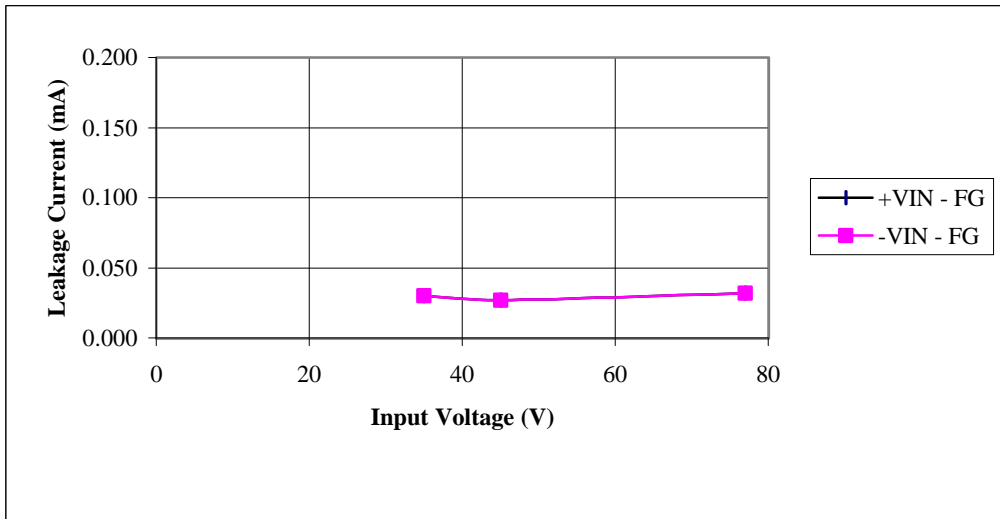

24V

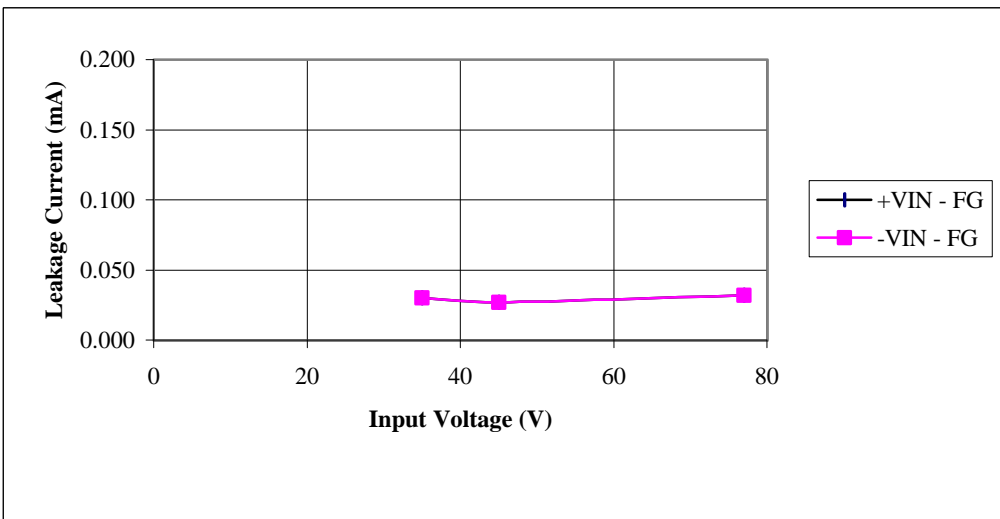

2-13 Dynamic Line Response Characteristics

Condition : $V_{in} = 43 \rightleftharpoons 53VDC$
 $I_{out} = 100\%$
 $T_p = 25^{\circ}C$

5 V

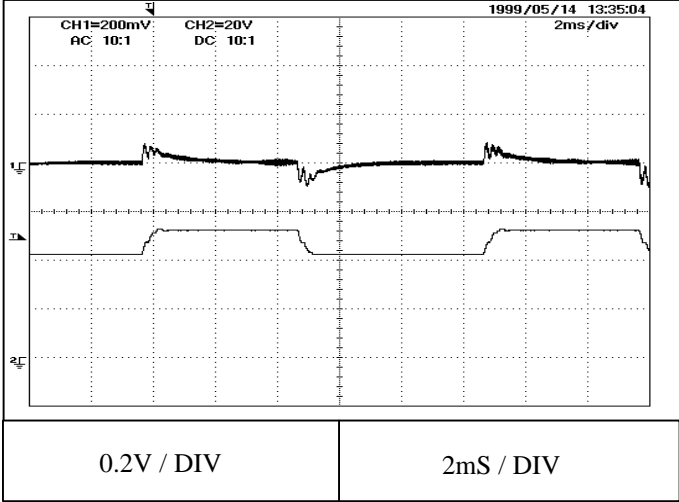

← Vout
← Vin

12 V

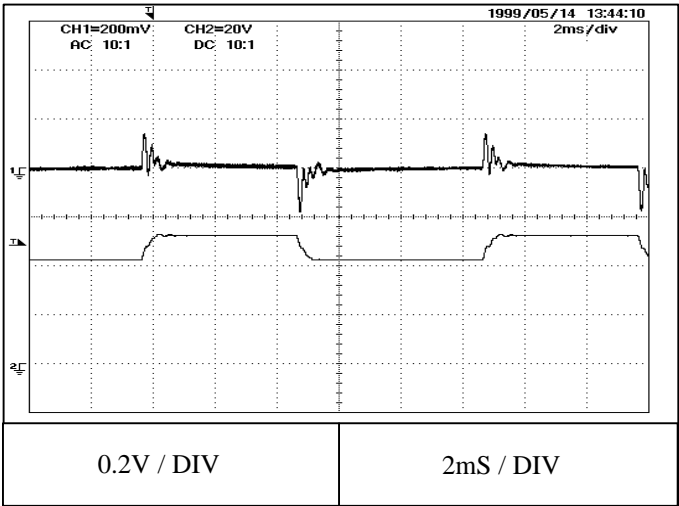

← Vout
← Vin

24 V

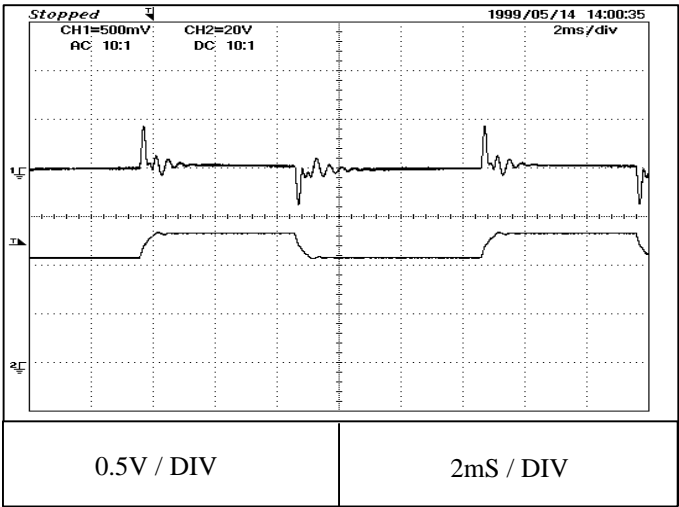

← Vout
← Vin

2-14 AC Input Response

Condition : $V_{in} = 48 \text{ VDC}$
 $I_{out} = 100\%$
 $T_p = 25^\circ\text{C}$

5V

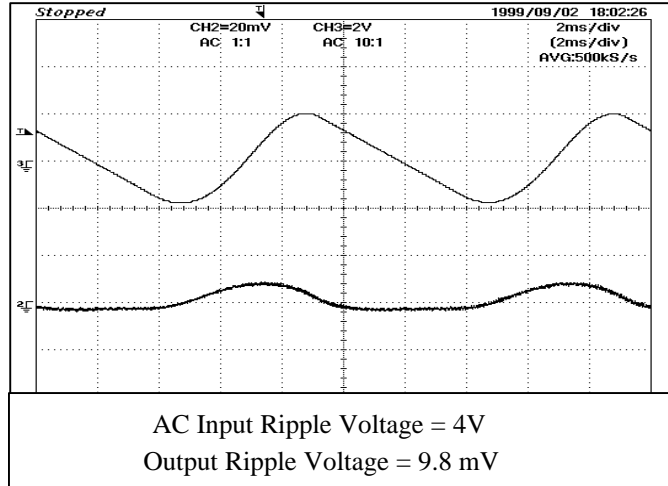

Input Waveform

Output Waveform

12V

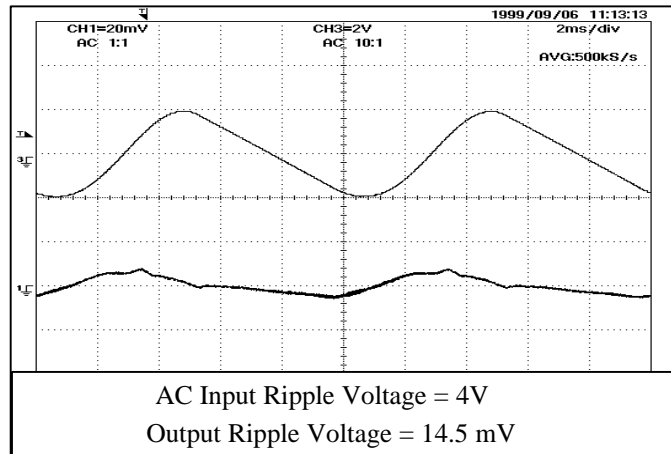

Input Waveform

Output Waveform

24V

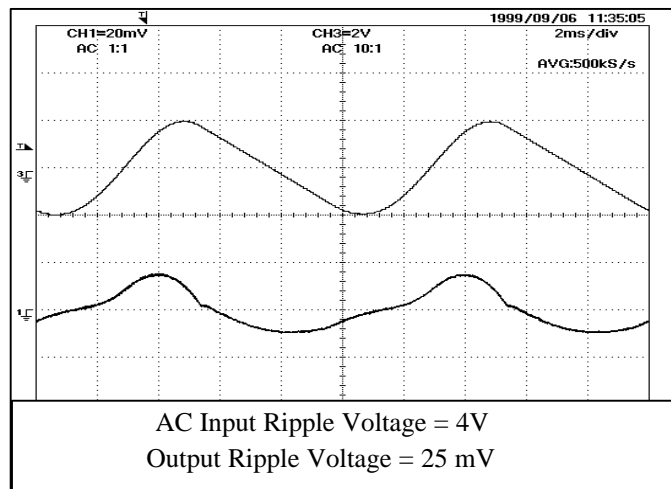

Input Waveform

Output Waveform

2-15 INPUT REFLECTED CURRENT

Condition : $V_{in} = 48 \text{ VDC}$
 $I_{out} = 100\%$
 $T_p = 25^\circ\text{C}$

5 V

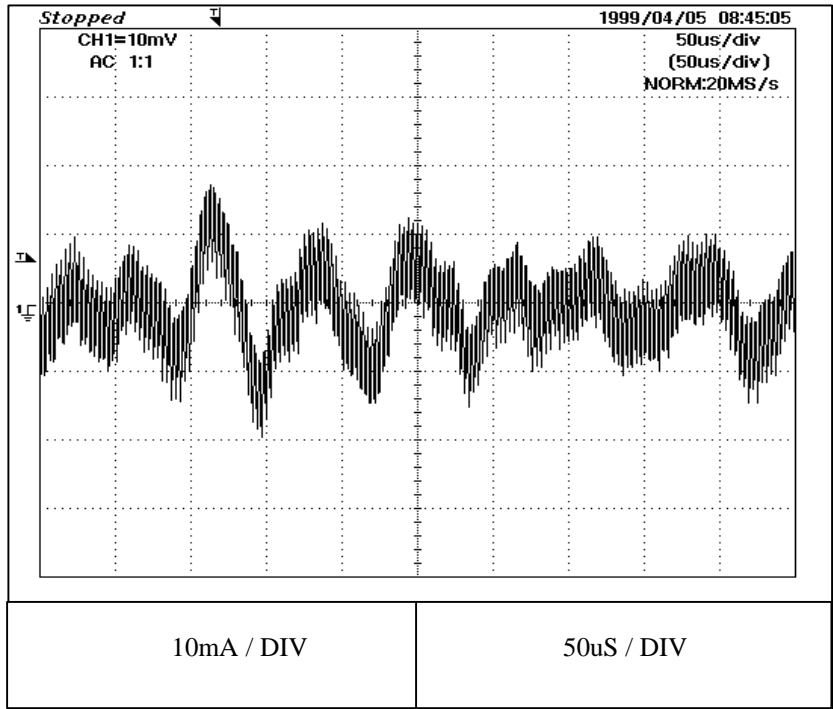
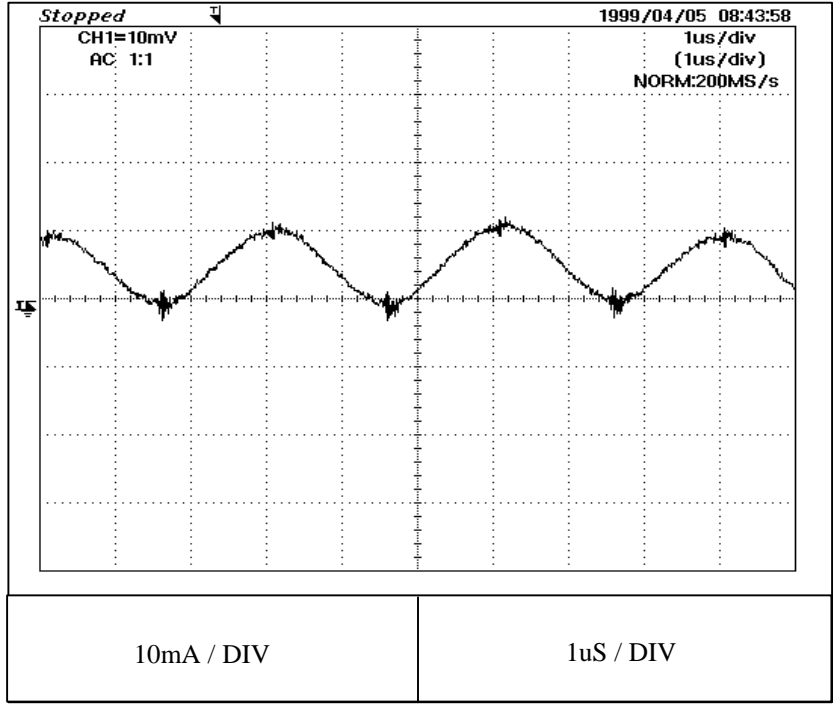

2-15 INPUT REFLECTED CURRENT

Condition : $V_{in} = 48 \text{ VDC}$
 $I_{out} = 100\%$
 $T_p = 25^\circ\text{C}$

12 V

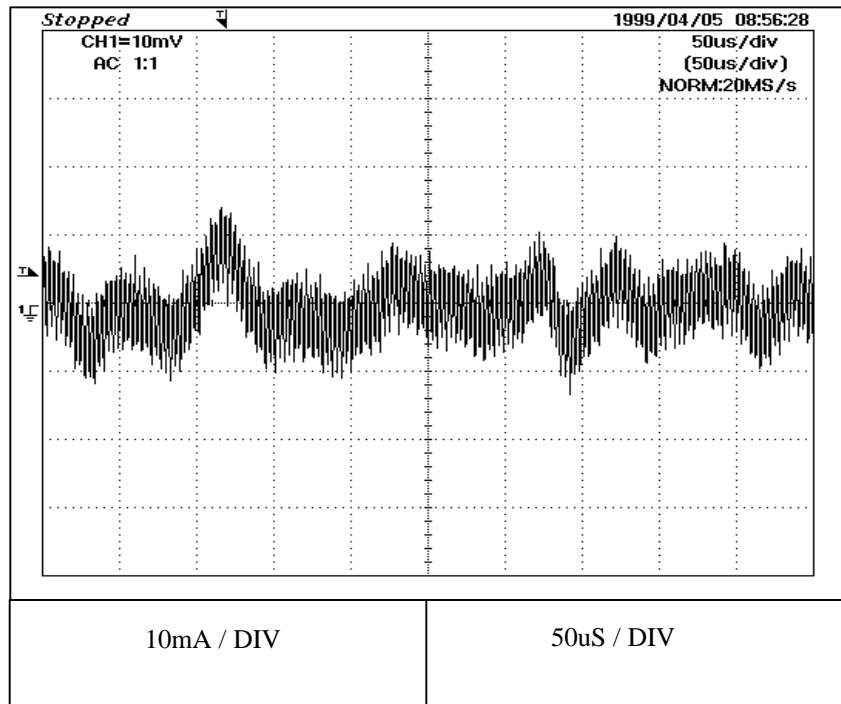
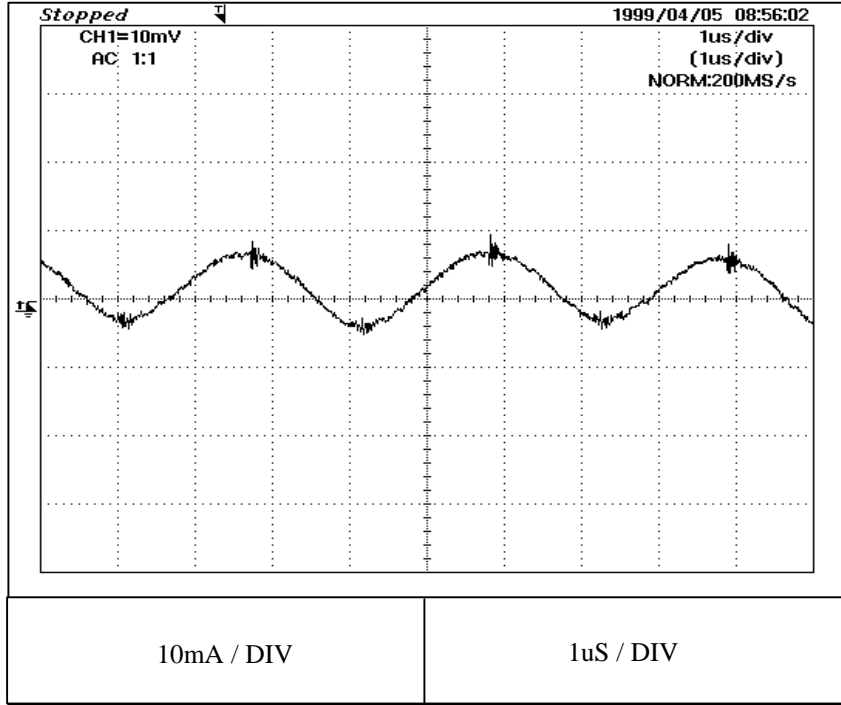

2-15 INPUT REFLECTED CURRENT

Condition Vin = 48 VDC
Iout = 100%
Tp = 25°C

24 V

