

PSS6-24- \*

# EVALUATION DATA

## 型式データ

DWG.No. C190-53-01B		
承認	査閲	担当
<i>H. Kimachi</i>	<i>K. Nakada</i>	<i>M. Nagai</i>
<i>3. Dec. '10</i>	<i>3. Dec. '10</i>	<i>3. Dec. '10</i>

DENSEI-LAMBDA

## INDEX

1. 測定方法	Evaluation Method	PAGE
1.1	測定回路 Circuits used for determination .....	T-1~5
	(1) 静特性 Steady state data	
	(2) 通電ドリフト特性 Warm up voltage drift characteristics	
	(3) 過電流保護特性 Over current protection (OCP) characteristics	
	(4) 出力立ち上がり特性 Output rise characteristics	
	(5) 出力立ち下がり特性 Output fall characteristics	
	(6) 出力立ち上がり特性 (ON/OFFコントロール時) Output rise characteristics with ON/OFF CONTROL	
	(7) 出力立ち下がり特性 (ON/OFFコントロール時) Output fall characteristics with ON/OFF CONTROL	
	(8) 過渡応答 (負荷急変) 特性 Dynamic load response characteristics	
	(9) 入力サージ電流 (突入電流) 特性 Inrush current characteristics	
	(10) 出力リップル、ノイズ波形 Output ripple and noise waveform	
	(11) スイッチング周波数対出力電力 Switching frequency v.s. output power	
	(12) EMI特性 Electro-Magnetic Interference characteristics	
1.2	使用測定機器 List of equipments used .....	T-6
2.	特性データ Characteristics	
2.1	(1) 入力・負荷・温度変動 Regulation - line and load, temperature drift .....	T-7~8
	(2) 出力電圧・リップル電圧対入力電圧 Output voltage and ripple voltage v.s. input voltage .....	T-9~10
	(3) 効率・入力電流対出力電流 Efficiency and input current v.s. output current .....	T-11~12
	(4) 効率対入力電圧 Efficiency v.s. input voltage .....	T-13~14
2.2	通電ドリフト特性 Warm up voltage drift characteristics .....	T-15
2.3	過電流保護特性 Over current protection (OCP) characteristics .....	T-16~17
2.4	出力立ち上がり特性 Output rise characteristics .....	T-18~19
2.5	出力立ち下がり特性 Output fall characteristics .....	T-20~21
2.6	出力立ち上がり特性 (ON/OFFコントロール時) Output rise characteristics with ON/OFF CONTROL .....	T-22~23
2.7	出力立ち下がり特性 (ON/OFFコントロール時) Output fall characteristics with ON/OFF CONTROL .....	T-24~25
2.8	過渡応答 (負荷急変) 特性 Dynamic load response characteristics .....	T-26~27

2.9 入力サージ電流 (突入電流) 特性	Inrush current waveform .....	T-28
2.10 出力リップル、ノイズ波形	Output ripple and noise waveform .....	T-29
2.11 スイッチング周波数対出力電力	Switching frequency v.s. output power .....	T-30
2.12 EMI特性	Electro-Magnetic Interference characteristics	
	VCCI class A 対応アプリケーションシステム	
	VCCI class A application system .....	T-31~32

#### 使用記号 Terminology used

	Definition		
Vin	.....	入力電圧	Input Voltage
Vout	.....	出力電圧	Output Voltage
Von/off	.....	ON/OFF電圧	ON/OFF Voltage
Iin	.....	入力電流	Input Current
Iout	.....	出力電流	Output Current
Ta	.....	周囲温度	Ambient Temperature

1. 測定方法 Evaluation Method

1.1 測定回路 Circuits used for determination

(1) 静特性 Steady state data

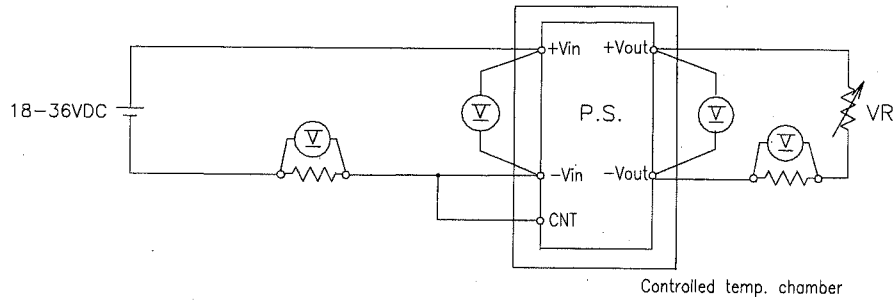

(2) 通電ドリフト特性 Warm up voltage drift characteristics

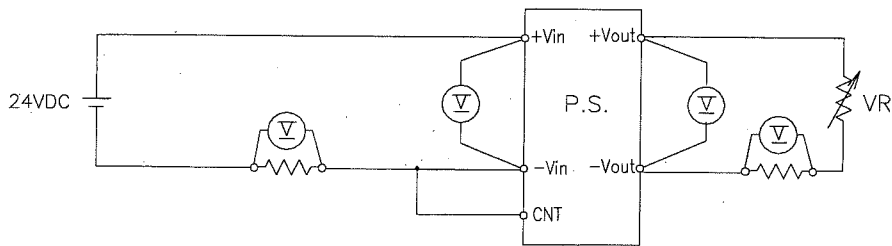

(3) 過電流保護特性 Over current protection (OCP) characteristics

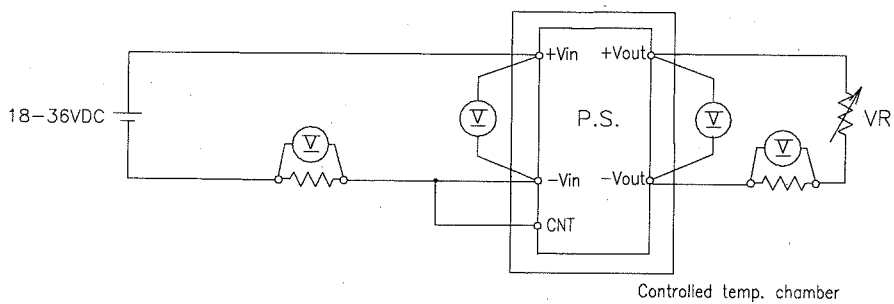

(4) 出力立ち上がり特性 Output rise characteristics

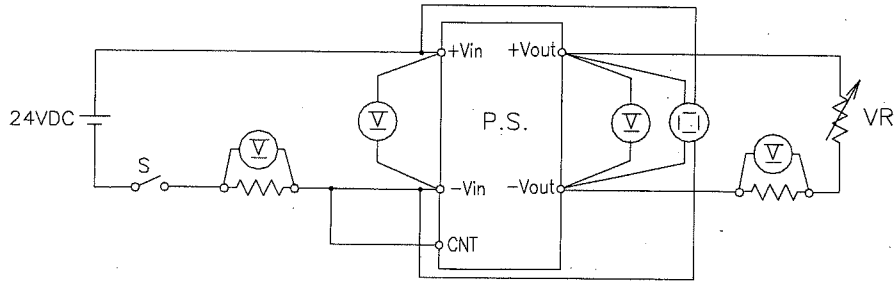

(5) 出力立ち下がり特性 Output fall characteristics

出力立ち上がり特性と同じ

Same as output rise characteristics

(6) 出力立ち上がり特性 (ON/OFFコントロール時)

Output rise characteristics with CONTROL ON/OFF

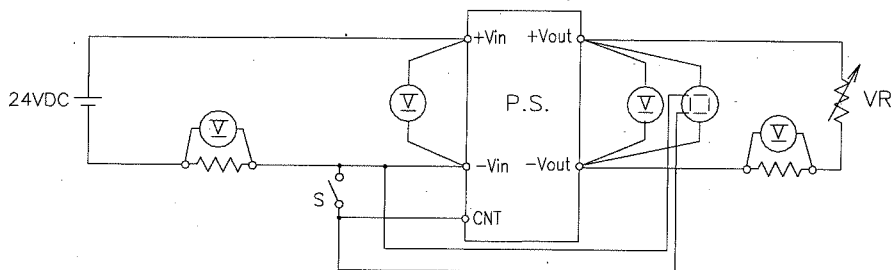

(7) 出力立ち下がり特性 (ON/OFFコントロール時)

Output fall characteristics with CONTROL ON/OFF

出力立ち上がり特性 (ON/OFFコントロール時) と同じ

Same as output rise characteristics with CONTROL ON/OFF

(8) 過渡応答(負荷急変)特性 Dynamic load response characteristics

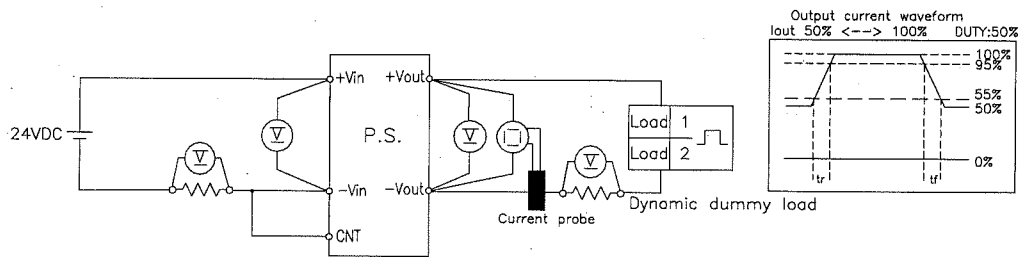

(9) 入力サージ電流 (突入電流) 特性 Inrush current characteristics

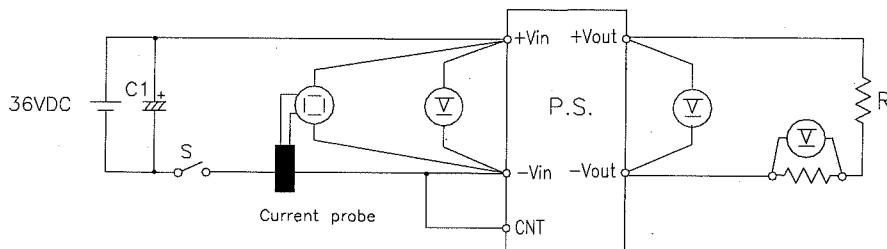

C1: 4000uF Electrolytic Capacitor

(10) 出力リップル、ノイズ波形 Output ripple and noise waveform

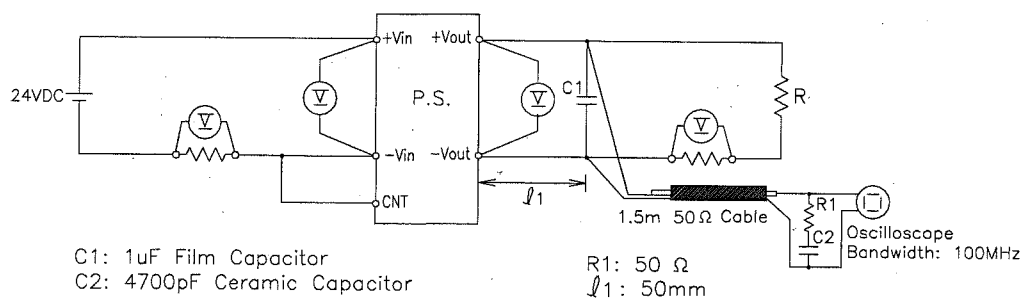

(11) スイッチング周波数対出力電力 Switching frequency v.s. output power

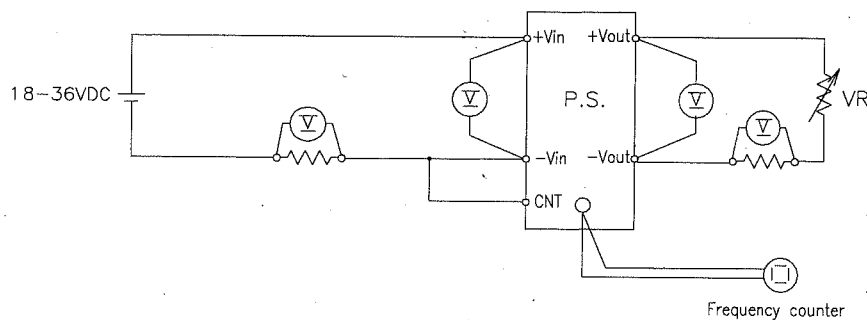

(12) EMI 特性 Electro-Magnetic Interference characteristics

(a) 雑音端子電圧 (帰還ノイズ) Conducted Emission Noise

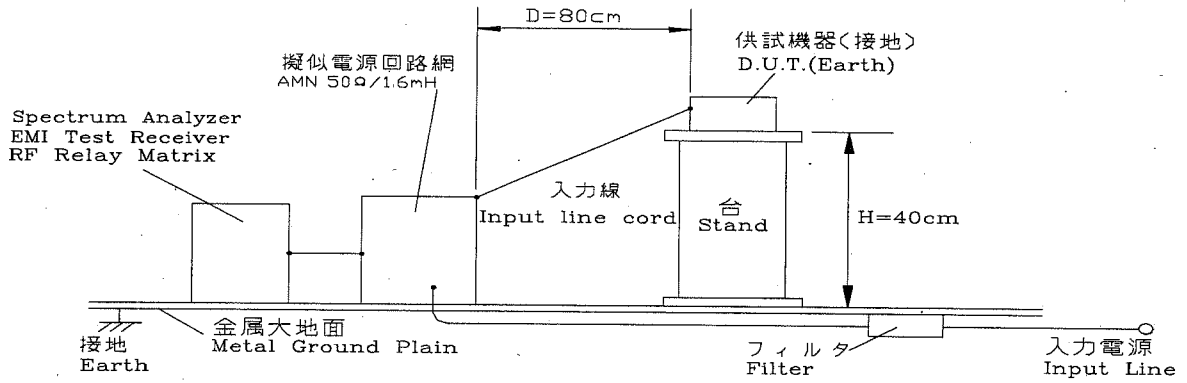

(b) 雑音電界強度 (輻射ノイズ) Radiated Emission Noise

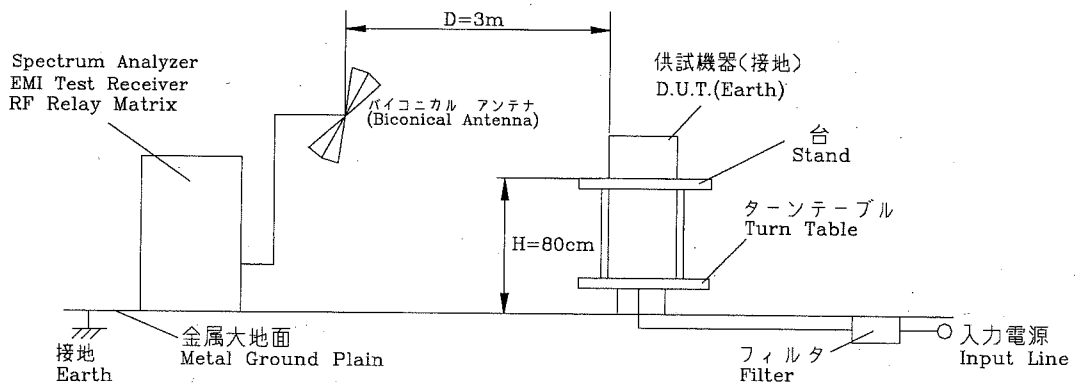

(1) VCCI class A 対応アプリケーションシステム

VCCI class A application system

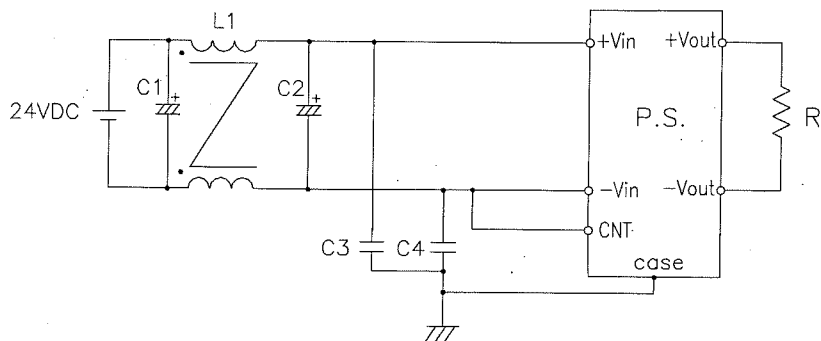

L1: 1mH  
 C1: 10uF Electrolytic Capacitor  
 C2: 100uF Electrolytic Capacitor  
 C3, C4 : 4700pF Ceramic Capacitor



## 1.2 使用測定機器 List of equipment used

	EQUIPMENT USED	MANUFACTURER	MODEL NO.
1	OSCILLO SCOPE	HITACHI DENSHI	V-1100A
2	DIGITAL STORAGE OSCILLOSCOPE	YOKOGAWA ELECT.	DL1740
3	DIGITAL MULTIMETER	AGILENT	34970A
4	CURRENT PROBE/AMPLIFIER	TEKTRONIX	A6303/TM503B
5	SHUNT RESISTER	YOKOGAWA ELECT.	2215
6	DYNAMIC DUMMY LOAD	TAKASAGO	FK-200L
7	INPUT POWER SUPPLY	TAKASAGO	AA2000XG
8	CONTROLLED TEMP. CHAMBER	TABAI ESPEC	SU-261
9	SPECTRUM ANALYZER	ROHDE & SCHWARZ	FSA
10	EMI TEST RECEIVER	ROHDE & SCHWARZ	ESHS10
11	EMI TEST RECEIVER	ROHDE & SCHWARZ	ESVS10
12	RF RELAY MATRIX	ROHDE & SCHWARZ	PSU
13	AMN	KYORITU DENSHI	KNW-242
14	ANTENNA(BICONICAL ANTENNA)	SCHWARZBECK	BBA9106

## 2. 特性データ Characteristics

## 2.1 静特性 Steady state data

(1) 入力、負荷、温度変動 Regulation - line and load, temperature drift

3.3V

## 1. Regulation - line and load

Condition Ta : 25°C

Iout \ Vin	18VDC	24VDC	36VDC	line regulation	
0%	3.267V	3.267V	3.267V	0.0mV	0.000%
50%	3.266V	3.267V	3.266V	0.0mV	0.000%
100%	3.266V	3.266V	3.266V	0.0mV	0.000%
load regulation	1.0mV	1.0mV	1.0mV		
	0.031%	0.031%	0.031%		

## 2. Temperature drift

Conditions Vin : 24VDC

Iout : 100%

Ta	-40°C	25°C	85°C	temperature stability	
Vout	3.240V	3.266V	3.273V	33.0mV	1.01%

5V

## 1. Regulation - line and load

Condition Ta : 25°C

Iout \ Vin	18VDC	24VDC	36VDC	line regulation	
0%	5.016V	5.017V	5.017V	1.0mV	0.020%
50%	5.016V	5.017V	5.017V	1.0mV	0.020%
100%	5.015V	5.016V	5.016V	1.0mV	0.020%
load regulation	1.0mV	1.0mV	1.0mV		
	0.020%	0.020%	0.020%		

## 2. Temperature drift

Conditions Vin : 24VDC

Iout : 100%

Ta	-40°C	25°C	85°C	temperature stability	
Vout	4.993V	5.016V	5.016V	23.0mV	0.46%

## 2. 特性データ Characteristics

## 2.1 静特性 Steady state data

(1) 入力・負荷・温度変動 Regulation - line and load, temperature drift

12V

## 1. Regulation - line and load

Condition Ta : 25°C

Iout \ Vin	18VDC	24VDC	36VDC	line regulation	
0%	12.063V	12.064V	12.065V	2.0mV	0.017%
50%	12.063V	12.064V	12.064V	1.0mV	0.008%
100%	12.063V	12.063V	12.064V	1.0mV	0.008%
load regulation	0.0mV	1.0mV	1.0mV		
	0.00%	0.01%	0.01%		

## 2. Temperature drift

Conditions Vin : 24VDC

Iout : 100%

Ta	-40°C	25°C	85°C	temperature stability	
Vout	12.004V	12.063V	12.071V	67.0mV	0.56%

2.1 (2) 出力電圧・リップル電圧対入力電圧  
Output voltage and ripple voltage v.s. input voltage

Conditions Iout : 100 %

Ta : -40 °C -----  
25 °C - - - - -  
85 °C ———

3.3V

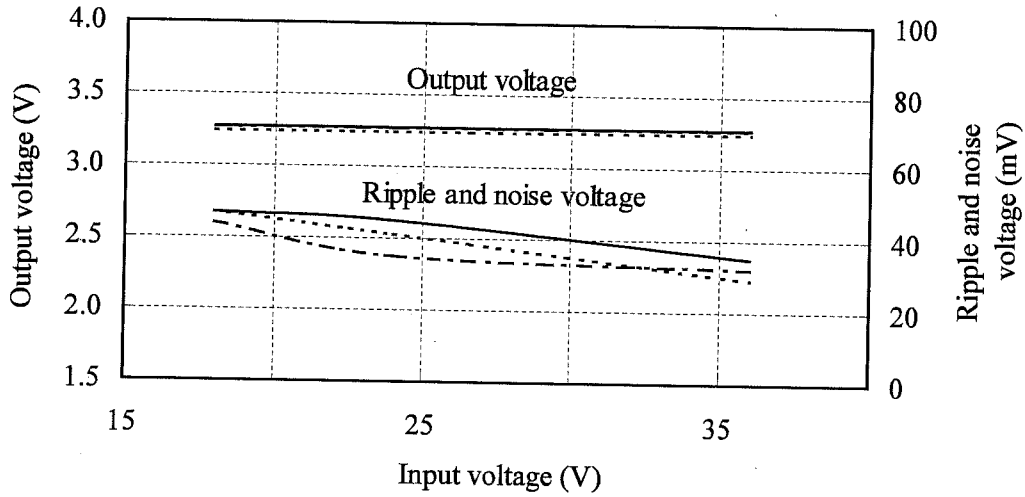

Ta : -40 °C -----  
25 °C - - - - -  
85 °C ———

5V

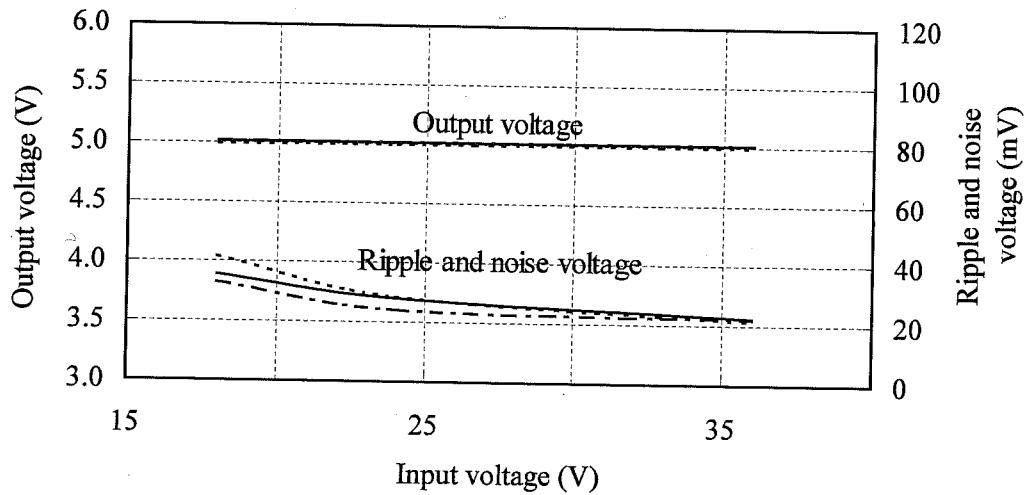

2.1 (2) 出力電圧・リップル電圧対入力電圧

Output voltage and ripple voltage v.s. input voltage

Conditions Iout : 100 %

Ta : -40 °C -----

25 °C - - - - -

85 °C \_\_\_\_\_

12V

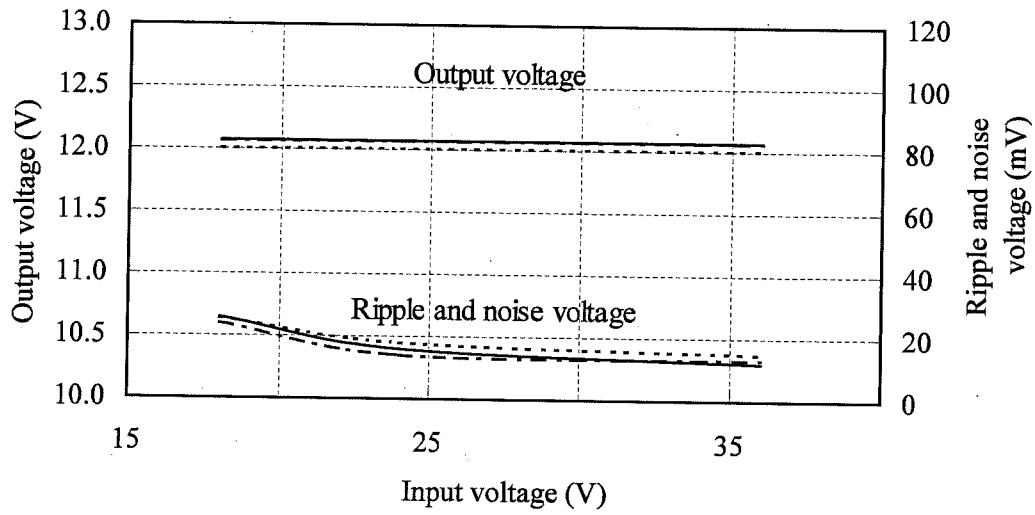

2.1 (3) 効率・入力電流対出力電流

Efficiency and input current v.s. output current

Conditions  $V_{in}$  : 18 VDC -----  
 : 24 VDC - - - - -  
 : 36 VDC ————  
 $T_a$  : 25 °C

3.3V

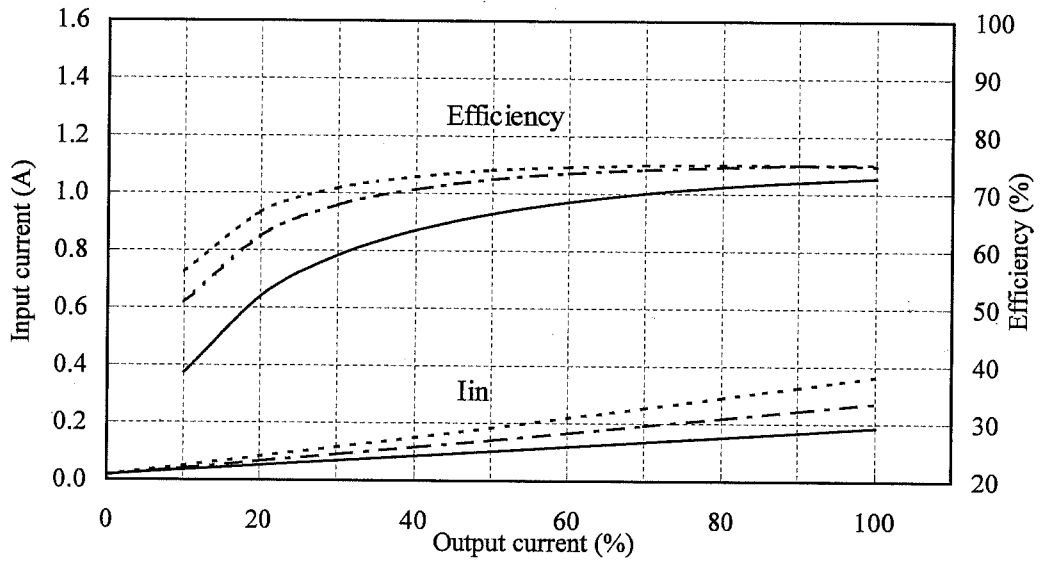

5V

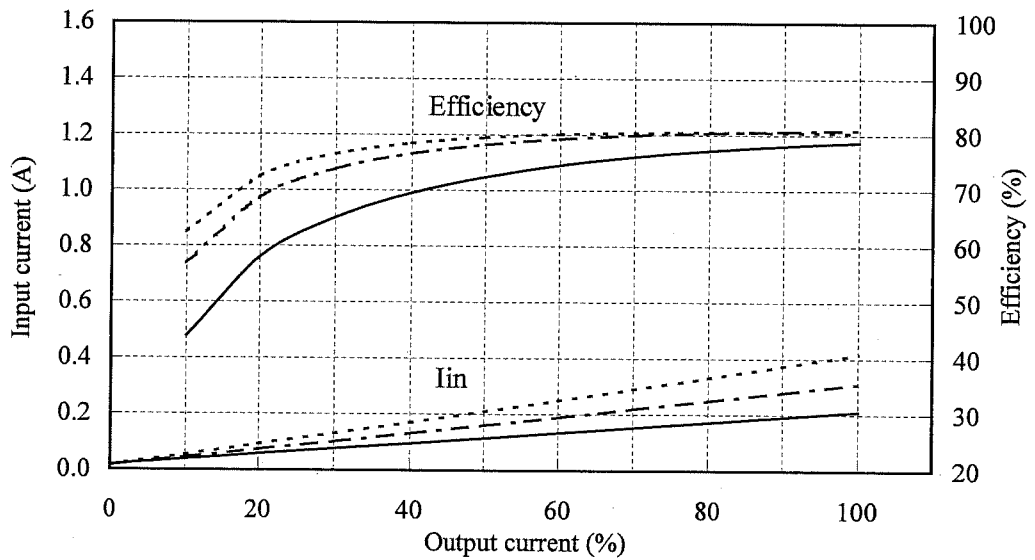

2.1 (3) 効率・入力電流対出力電流

Efficiency and input current v.s. output current

Conditions  $V_{in}$  : 18 VDC -----  
 : 24 VDC - - - - -  
 : 36 VDC ————  
 $T_a$  : 25 °C

12V

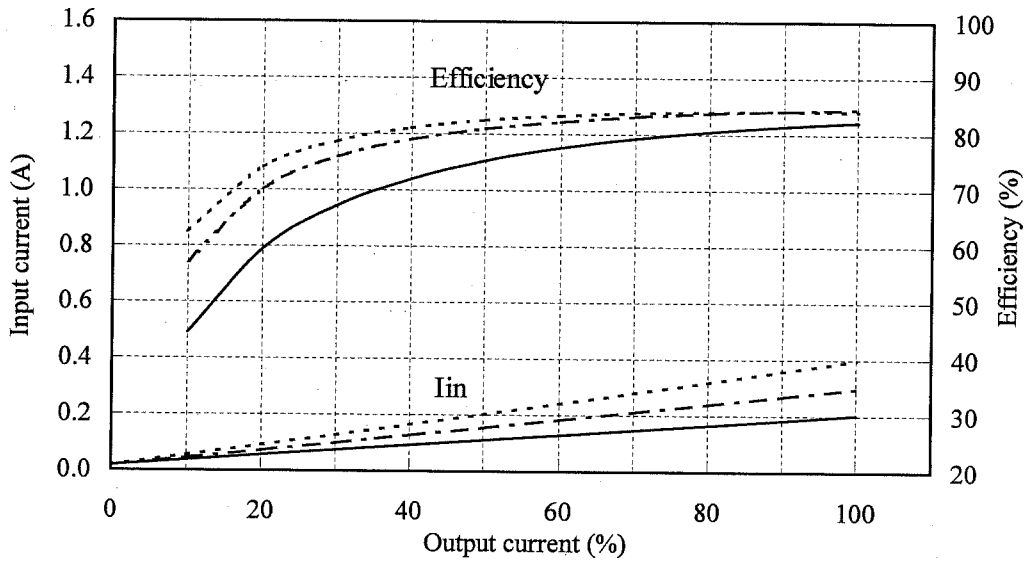

2.1 (4) 効率対入力電圧  
Efficiency v.s. input voltage

Conditions Ta : 25 °C

Iout : 50 % -----

100 % \_\_\_\_\_

3.3V

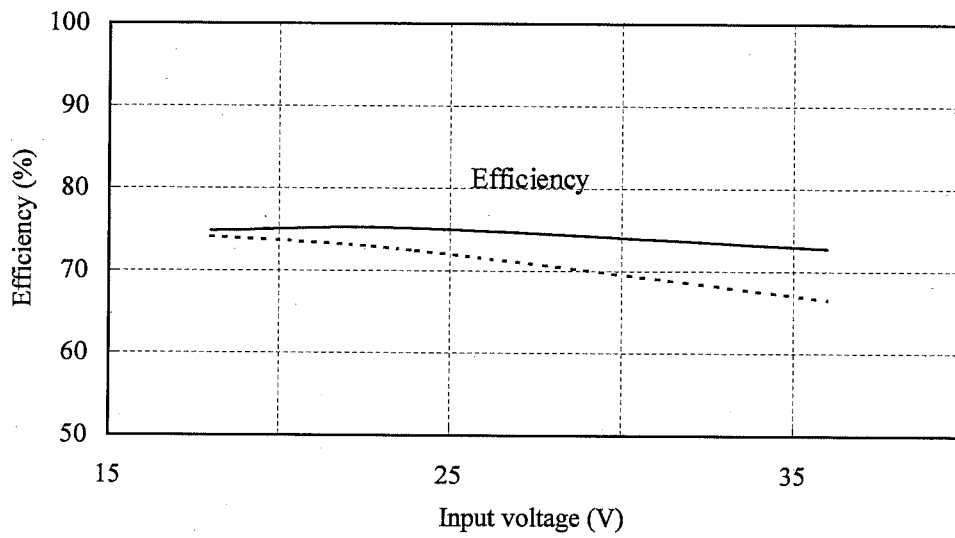

5V

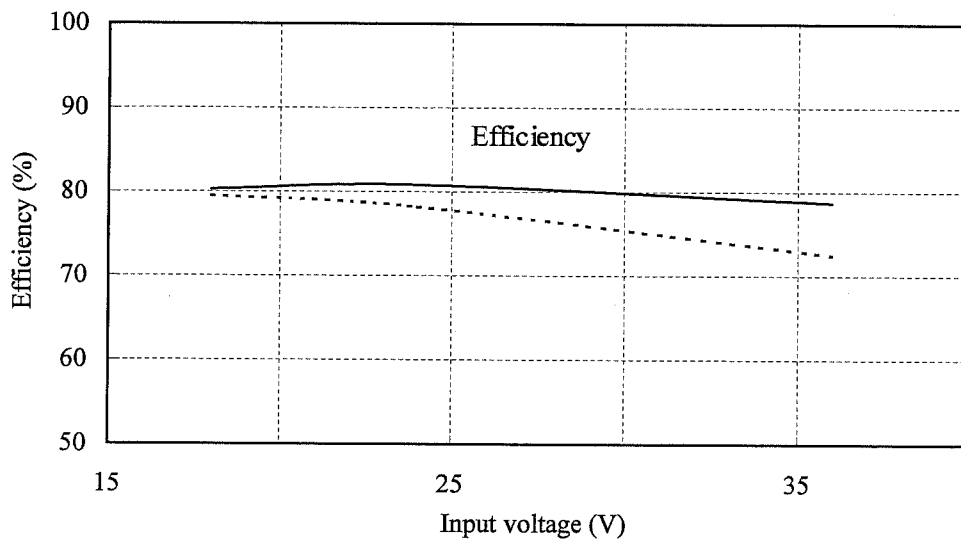



2.1 (4) 効率対入力電圧  
Efficiency v.s. input voltage

Conditions Ta : 25 °C

Iout : 50 % -----

100 % \_\_\_\_\_

12V

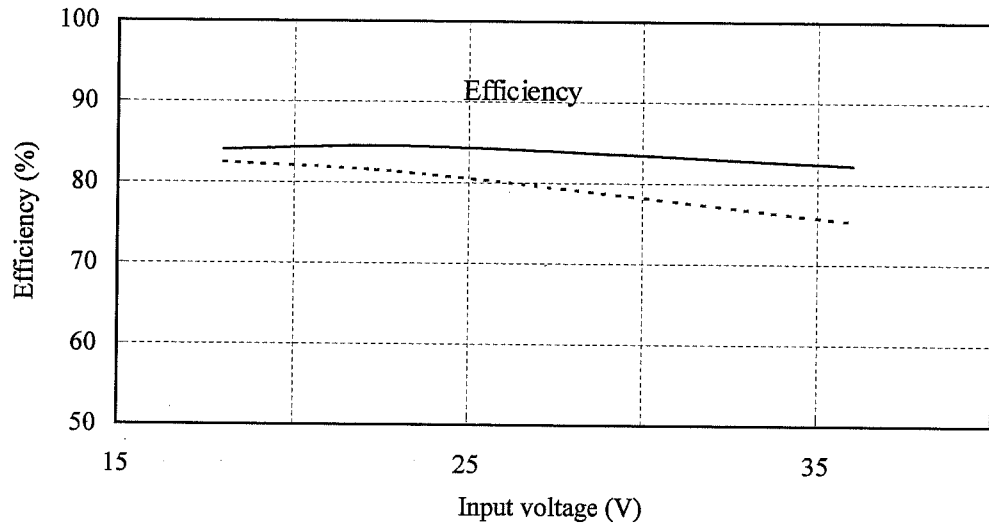

2.2 通電ドリフト特性  
Warm up voltage drift characteristics

Conditions  $V_{in}$  : 24 VDC  
 $I_{out}$  : 100 %  
 $T_a$  : 25 °C

3.3V

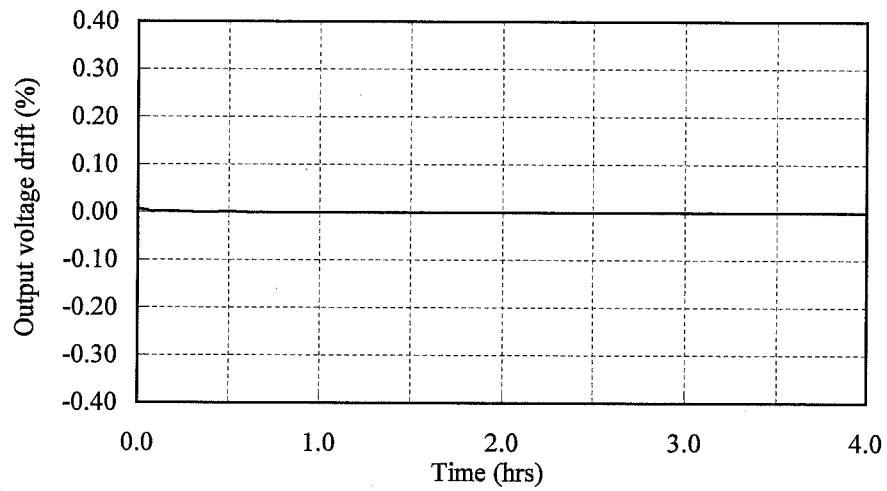

5V

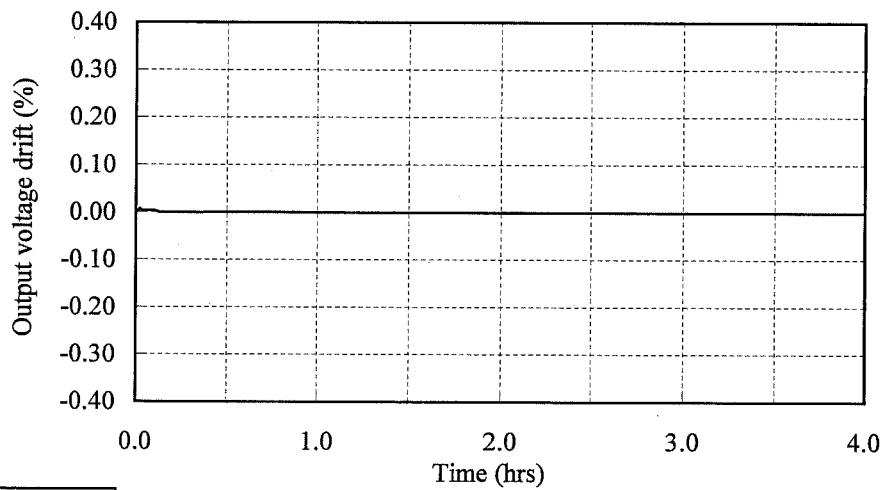

12V

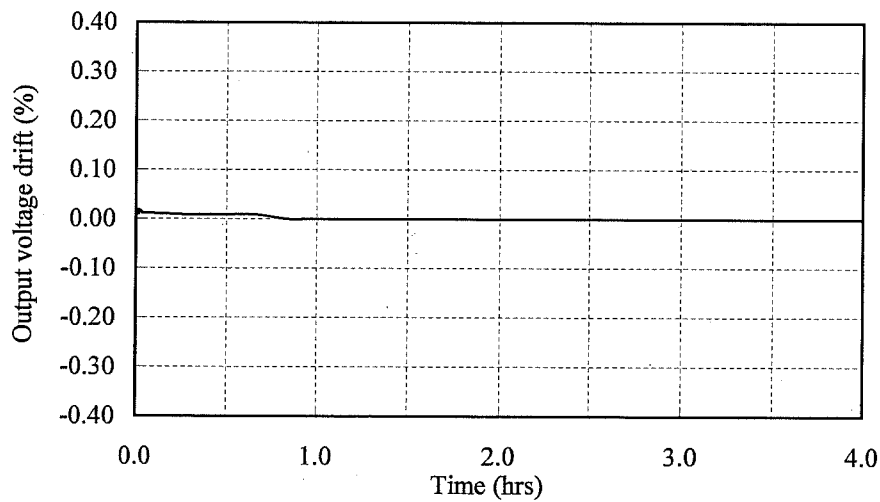

2.3 過電流保護特性

Over current protection (OCP) characteristics

Conditions Vin : 18 VDC -----  
 24 VDC - - - - -  
 36 VDC ————

Ta : 25 °C

**3.3V**

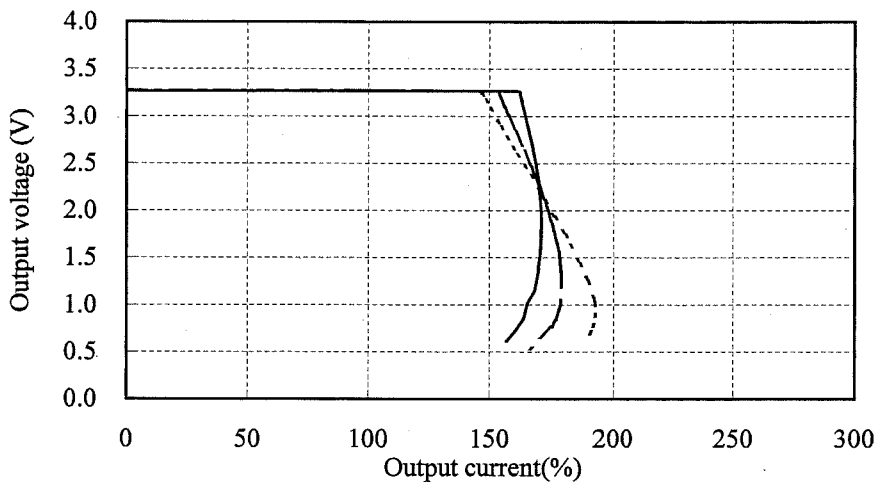

**5V**

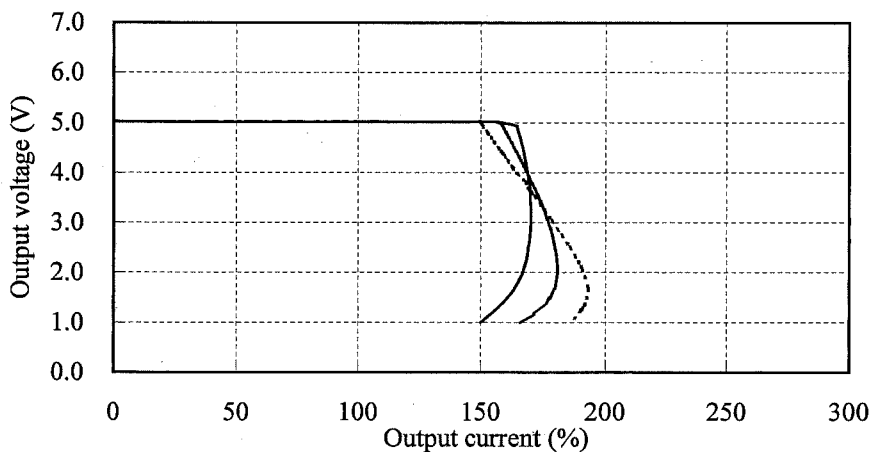

**12V**

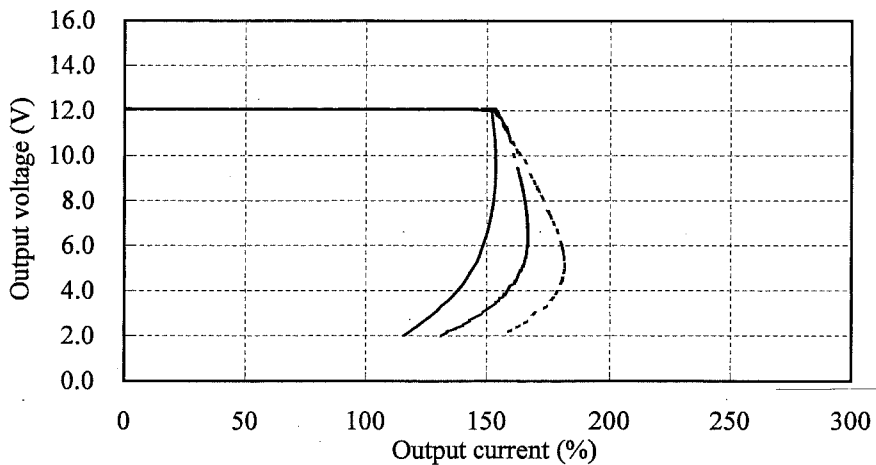

2.3 過電流保護特性

Over current protection (OCP) characteristics

Conditions  $V_{in}$  : 24 VDC

$T_a$  : -40 °C -----

25 °C - - - - -

85 °C ———

**3.3V**

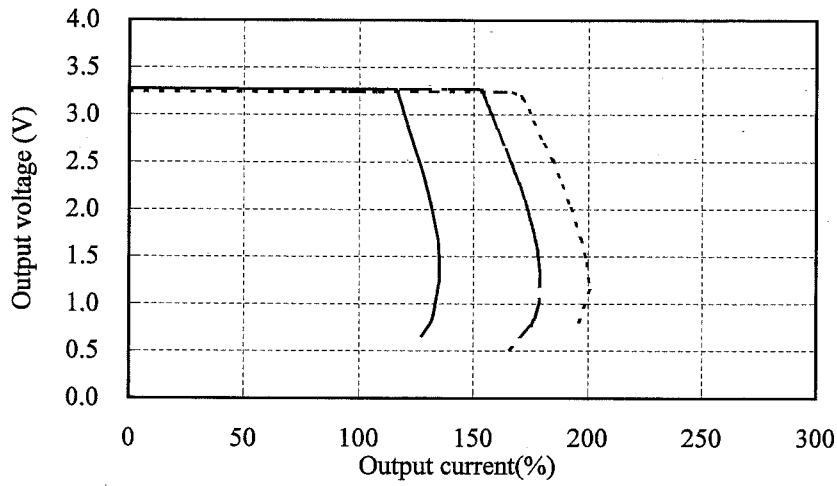

**5V**

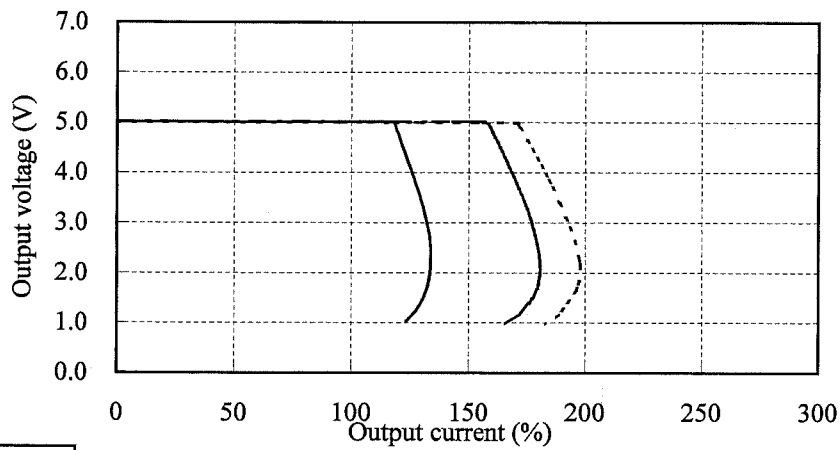

**12V**

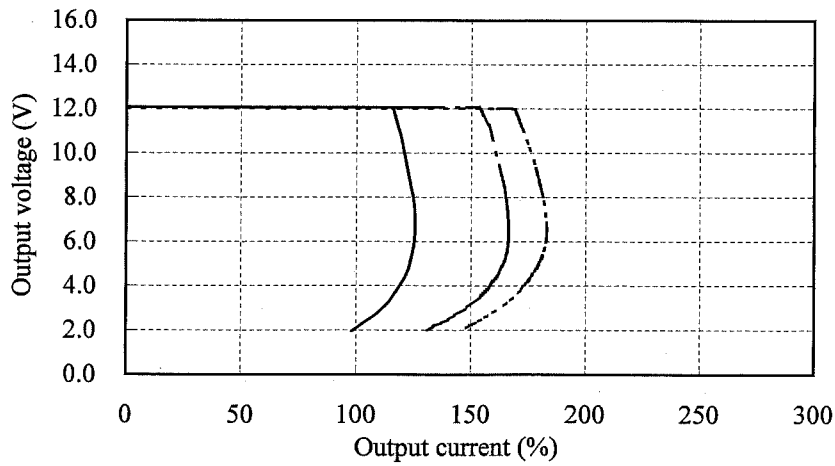

2.4 出力立ち上がり特性  
Output rise characteristics

PSS6-24-\*

Conditions Vin : 24 VDC  
Iout : 0 %  
Ta : 25 °C

3.3V

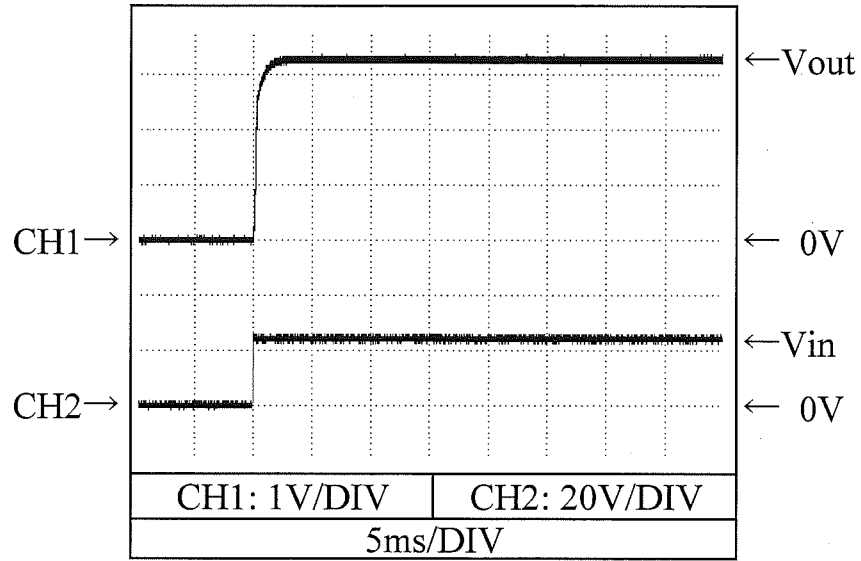

5V

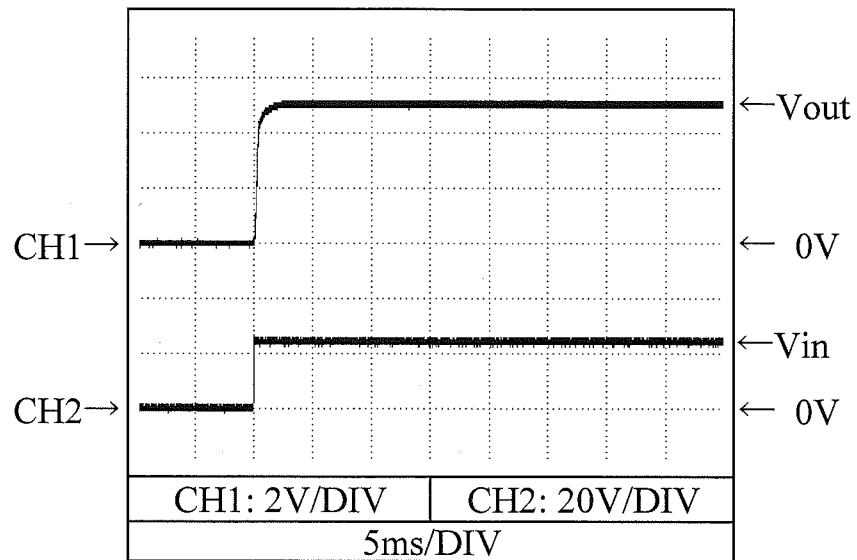

12V

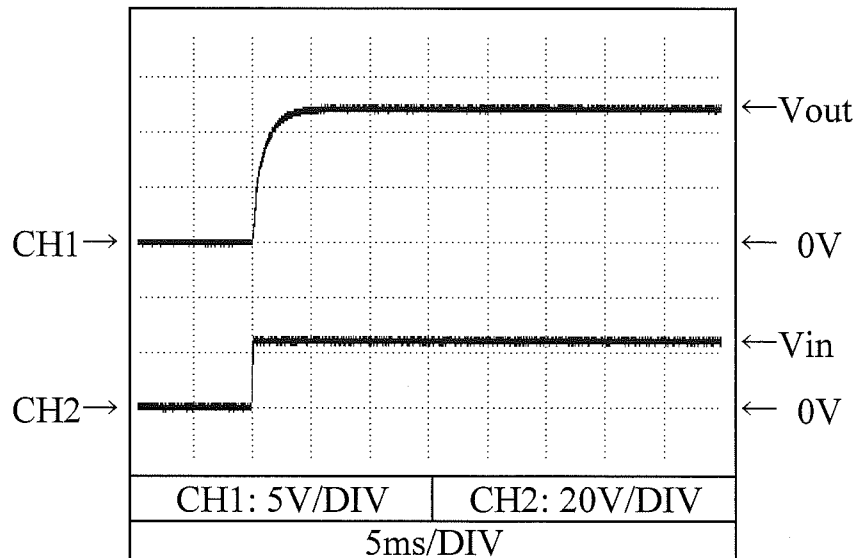

2.4 出力立ち上がり特性  
Output rise characteristics

PSS6-24-\*

Conditions Vin : 24 VDC  
Iout : 100 %  
Ta : 25 °C

3.3V

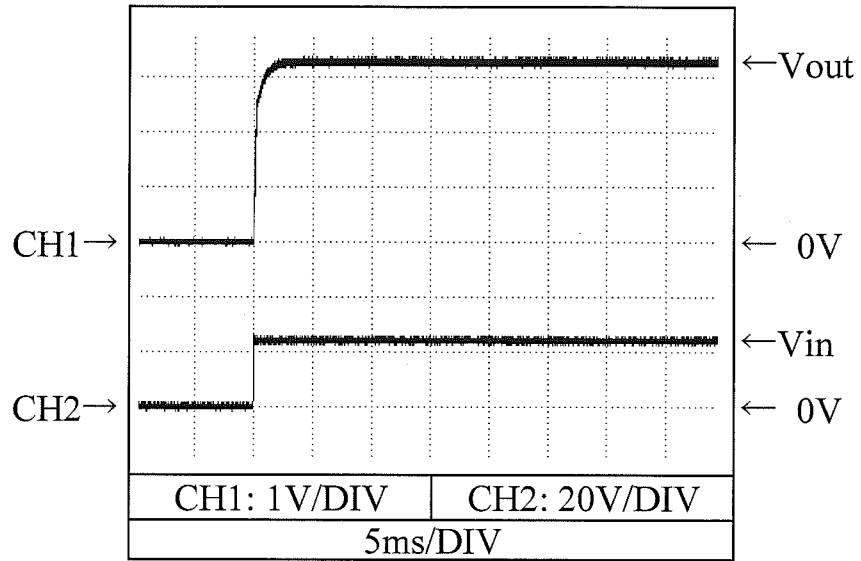

5V

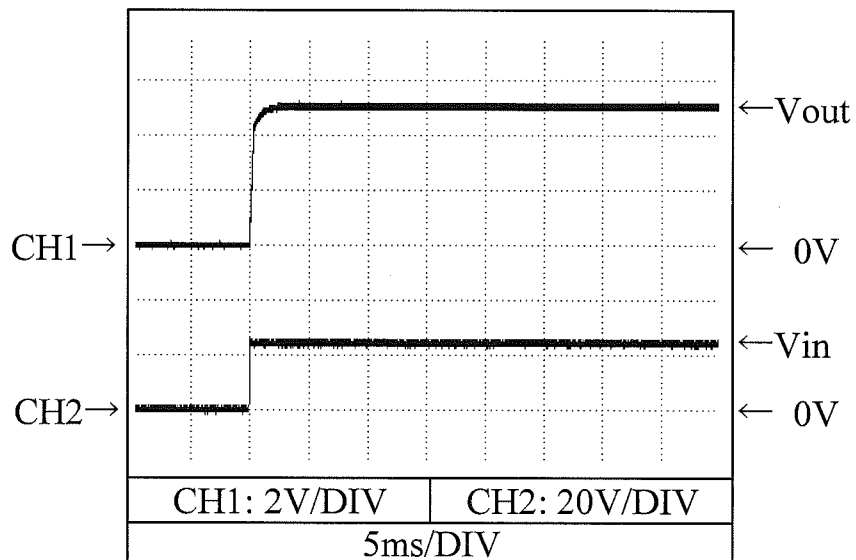

12V

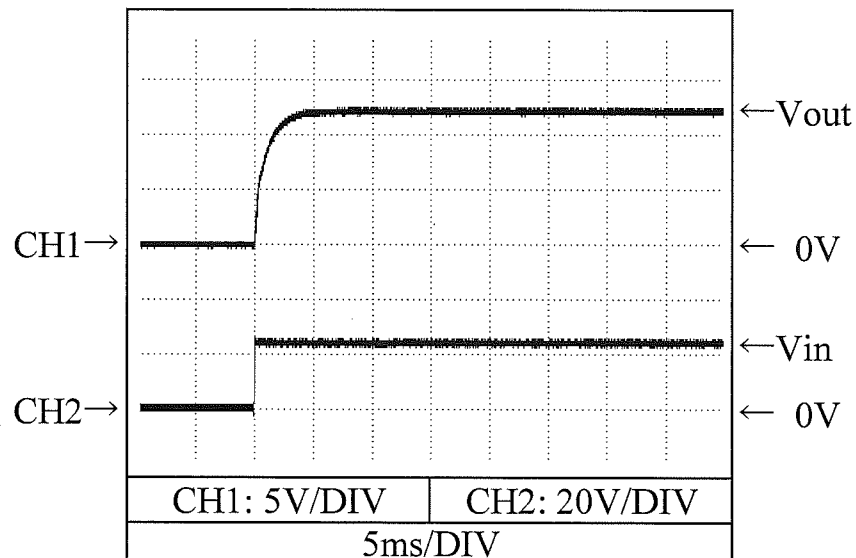

2.5 出力立ち下がり特性  
Output fall characteristics

PSS6-24-\*

Conditions Vin : 24 VDC  
Iout : 0 %  
Ta : 25 °C

3.3V

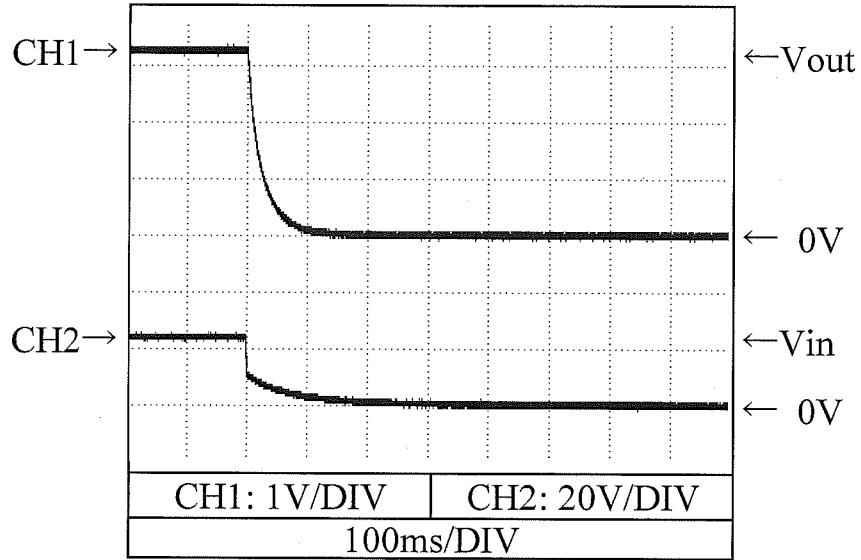

5V

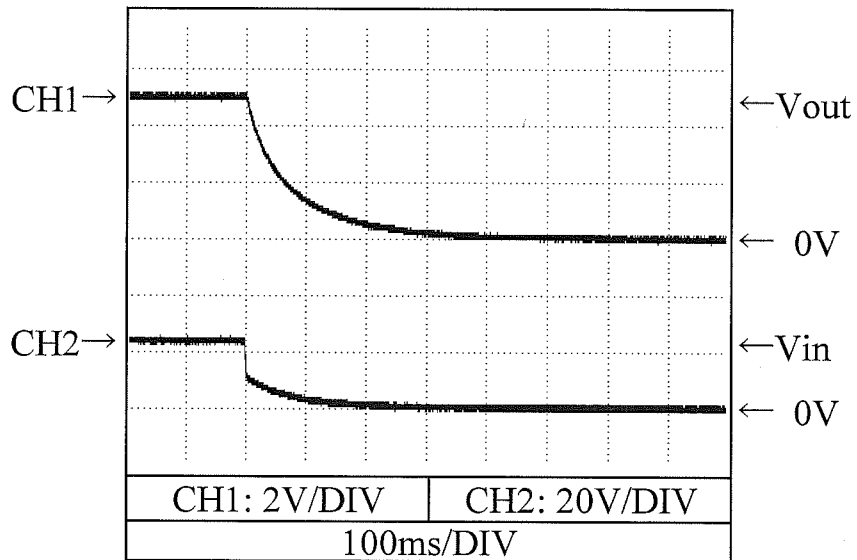

12V

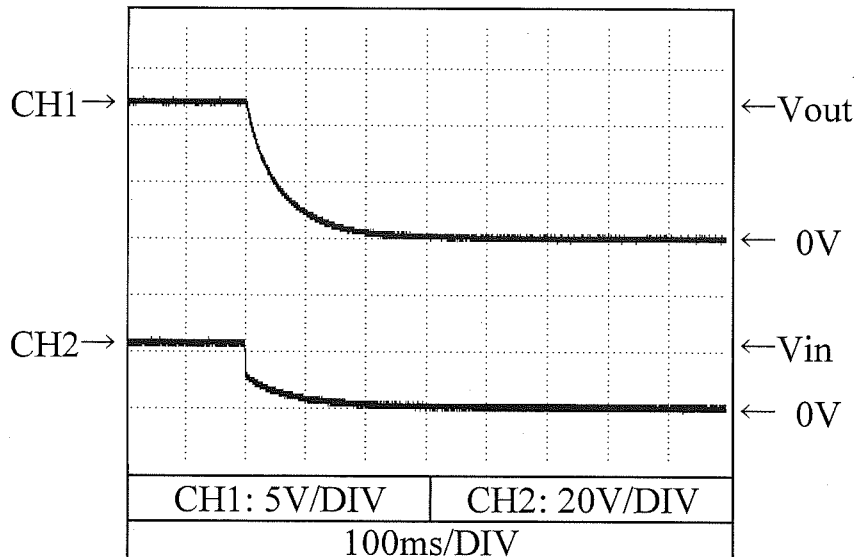

2.5 出力立ち下がり特性  
Output fall characteristics

PSS6-24-\*

Conditions Vin : 24 VDC  
Iout : 100 %  
Ta : 25 °C

3.3V

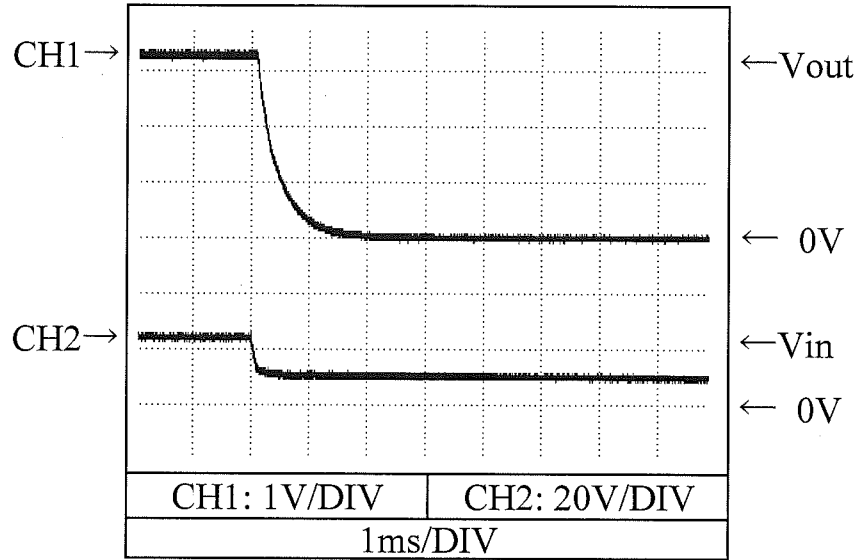

5V

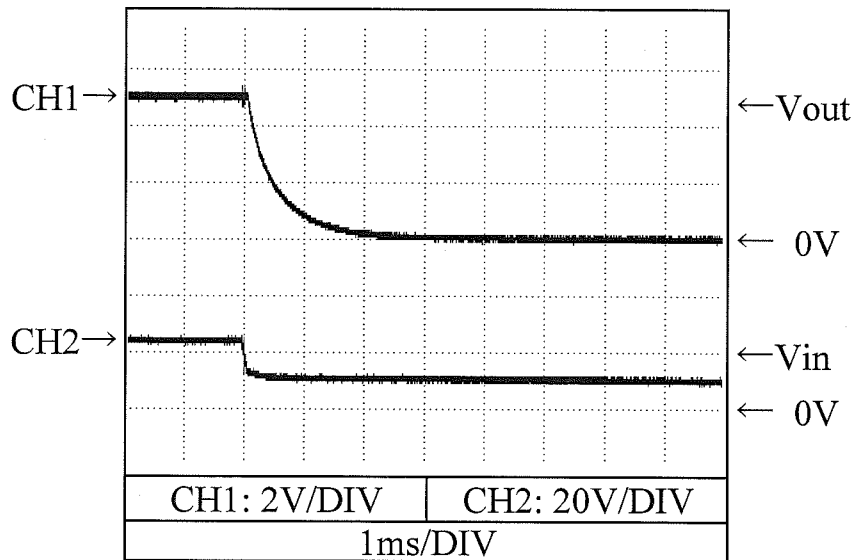

12V

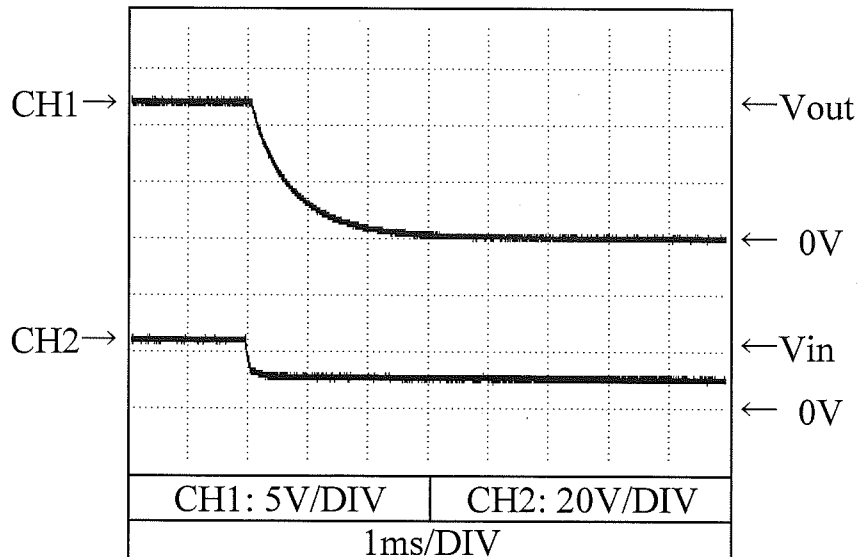



2.6 出力立ち上がり特性 (ON/OFFコントロール時)  
Output rise characteristics with ON/OFF CONTROL

PSS6-24-\*

Conditions Vin : 24 VDC  
Iout : 0 %  
Ta : 25 °C

3.3V

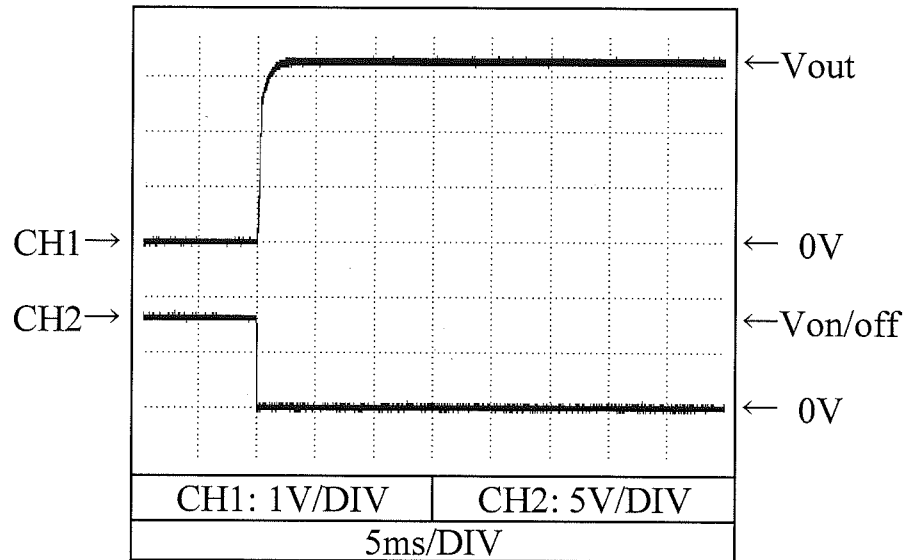

5V

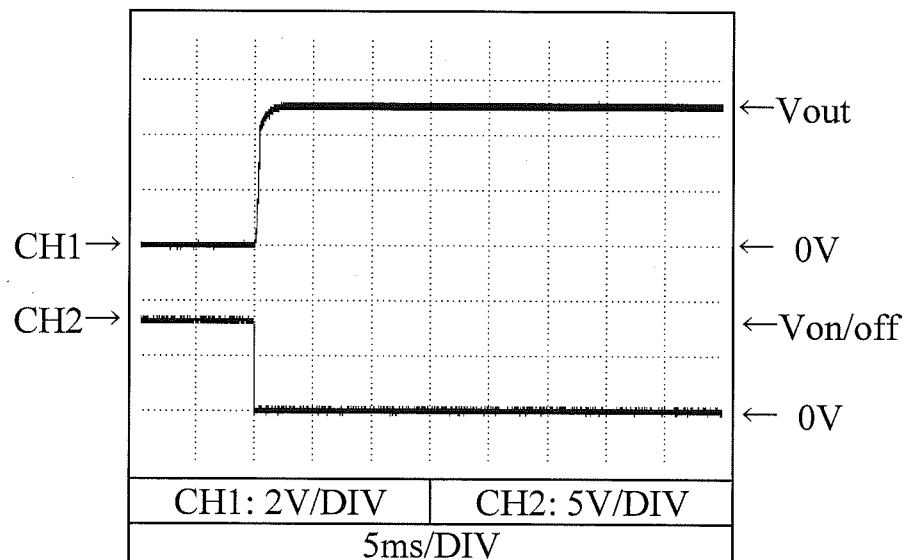

12V

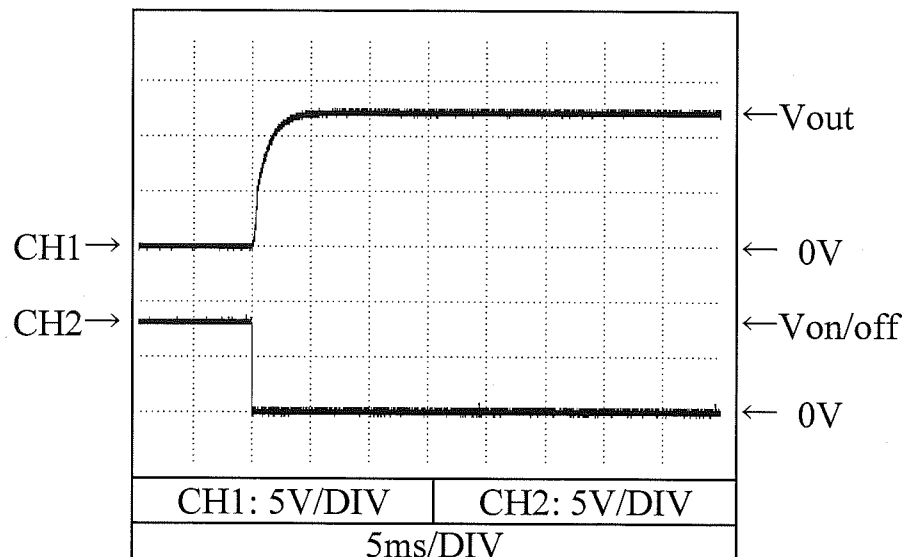

2.6 出力立ち上がり特性 (ON/OFF コントロール時)  
Output rise characteristics with ON/OFF CONTROL

PSS6-24-\*

Conditions Vin : 24 VDC  
Iout : 100 %  
Ta : 25 °C

3.3V

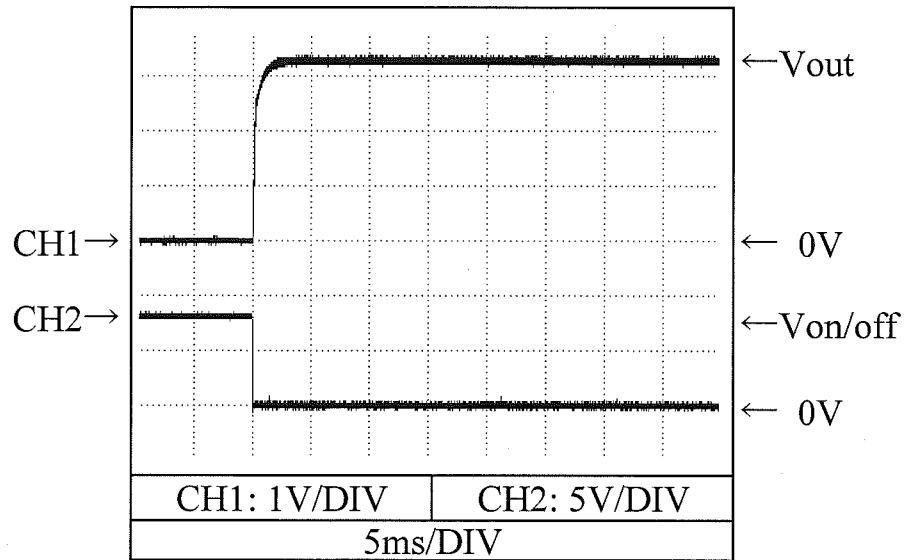

5V

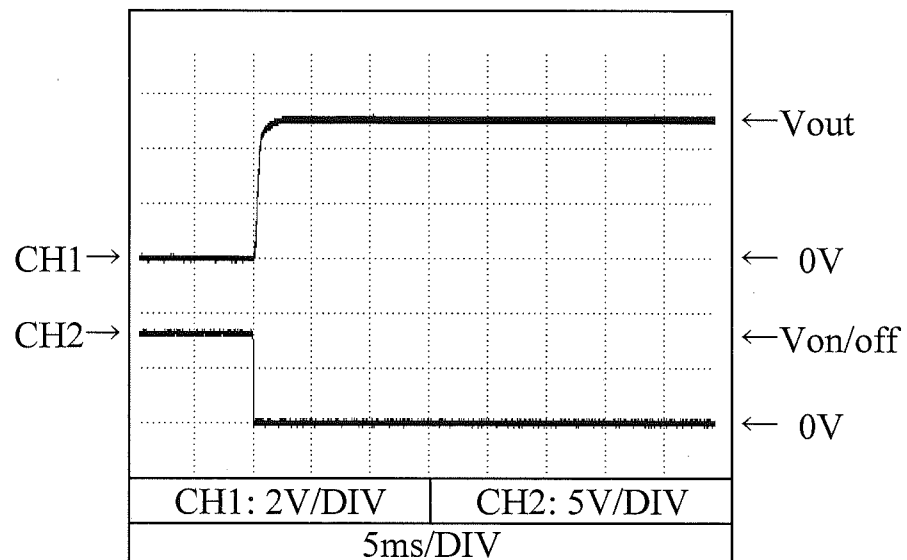

12V

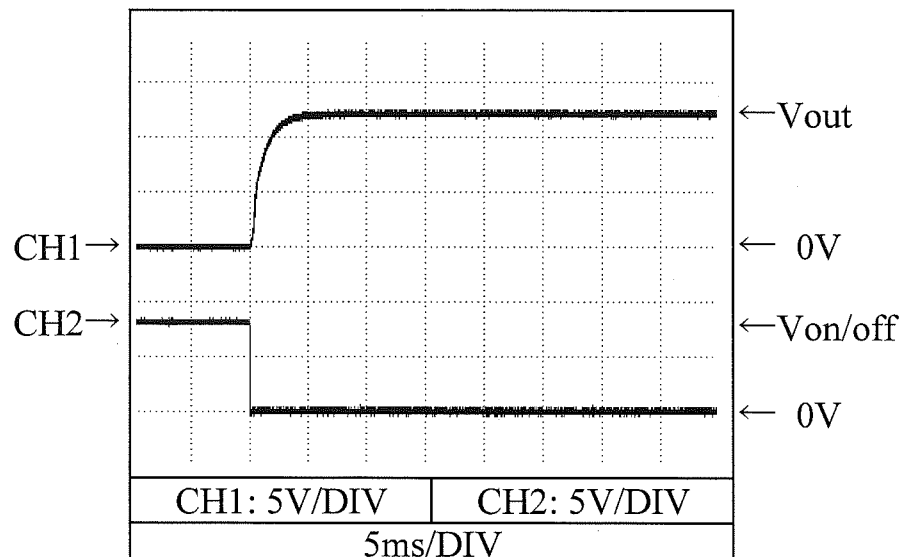

2.7 出力立ち下がり特性 (ON/OFFコントロール時)  
Output fall characteristics with ON/OFF CONTROL

PSS6-24-\*

Conditions Vin : 24 VDC  
Iout : 0 %  
Ta : 25 °C

3.3V

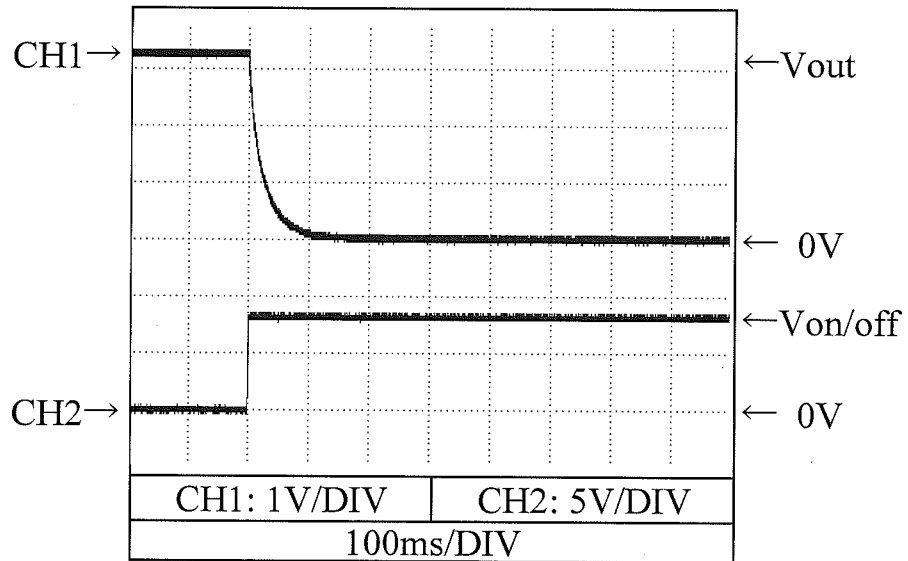

5V

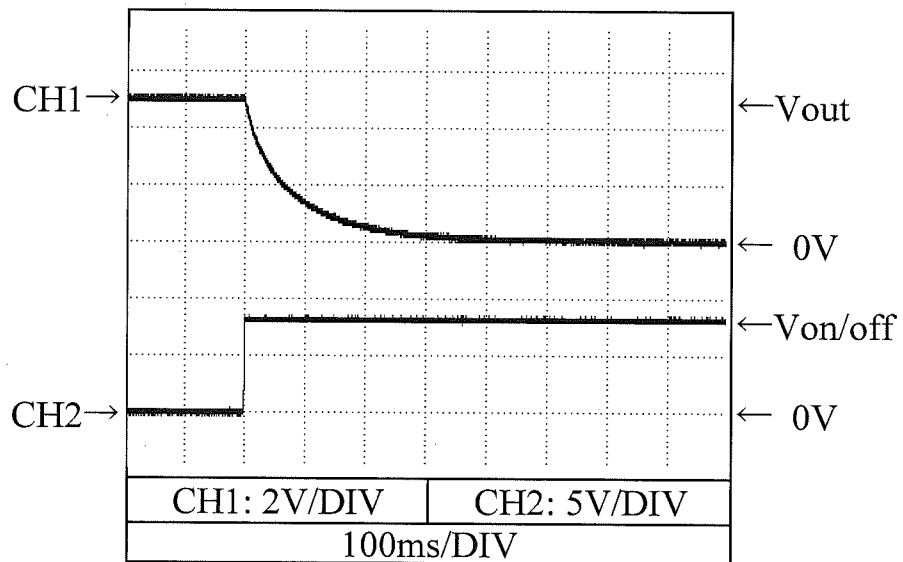

12V

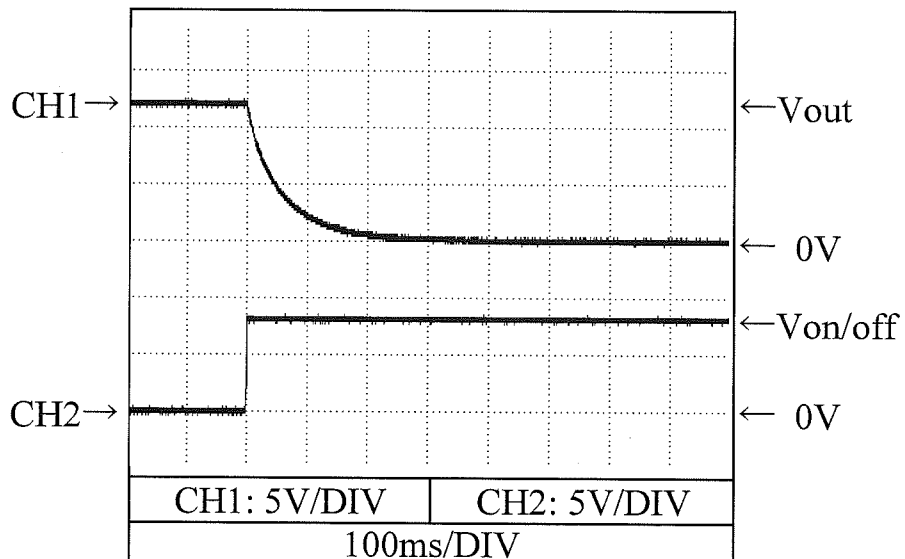

2.7 出力立ち下がり特性 (ON/OFF コントロール時)  
Output fall characteristics with ON/OFF CONTROL

PSS6-24-\*

Conditions Vin : 24 VDC  
Iout : 100 %  
Ta : 25 °C

3.3V

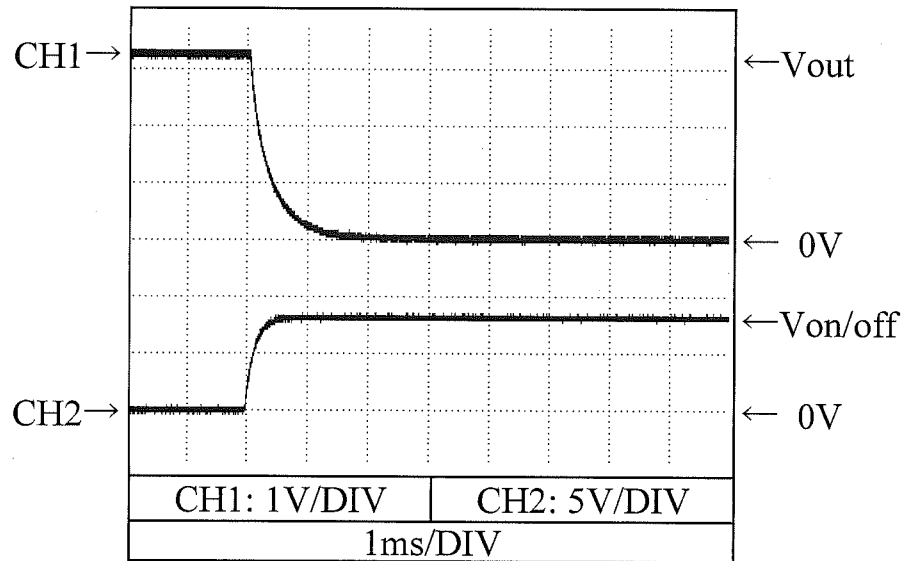

5V

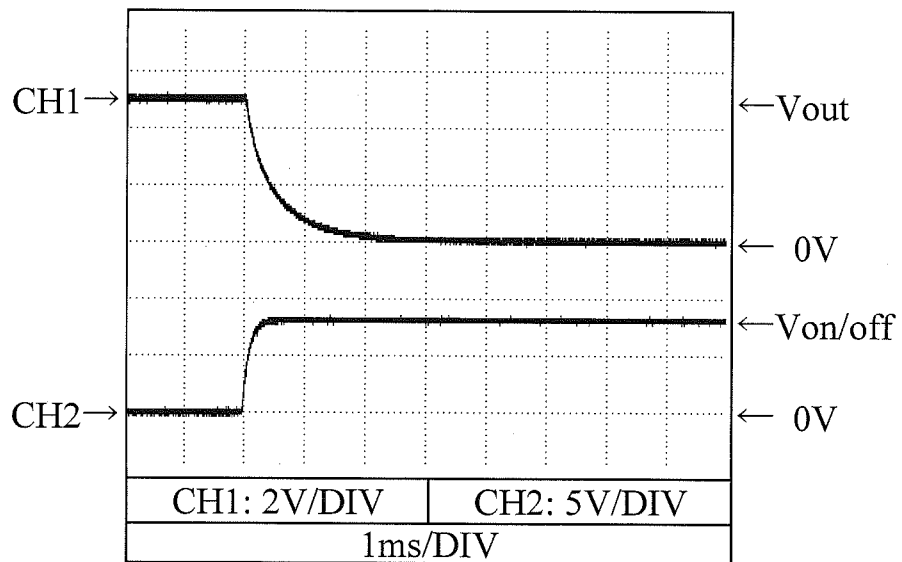

12V

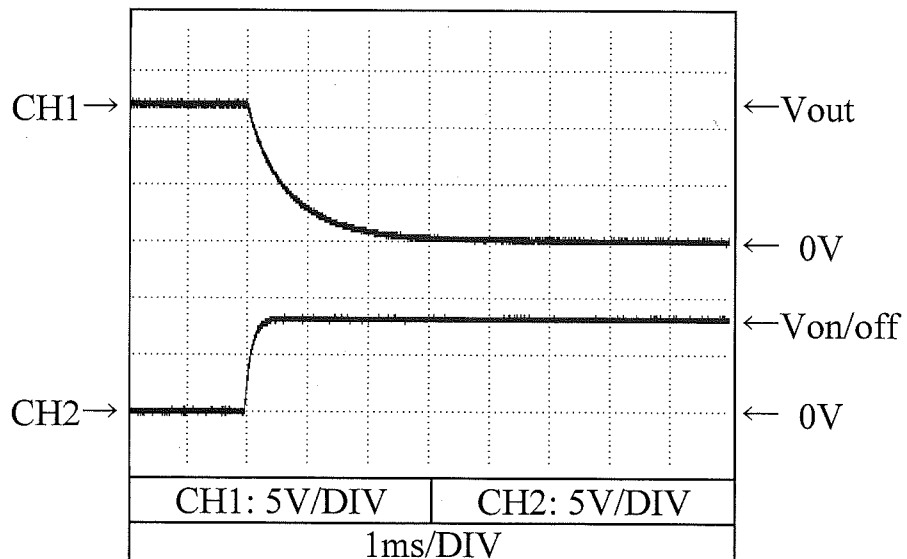

2.8 過渡応答 (負荷急変) 特性  
 Dynamic load response characteristics

Conditions Vin : 24 VDC  
 Ta : 25 °C

3.3V

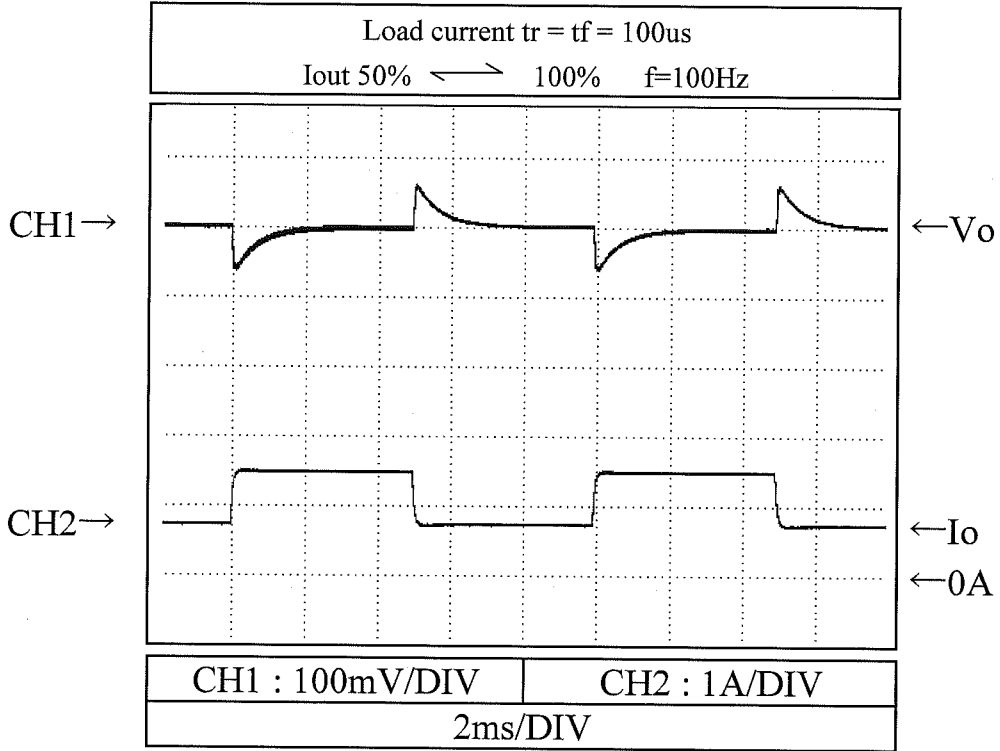

5V

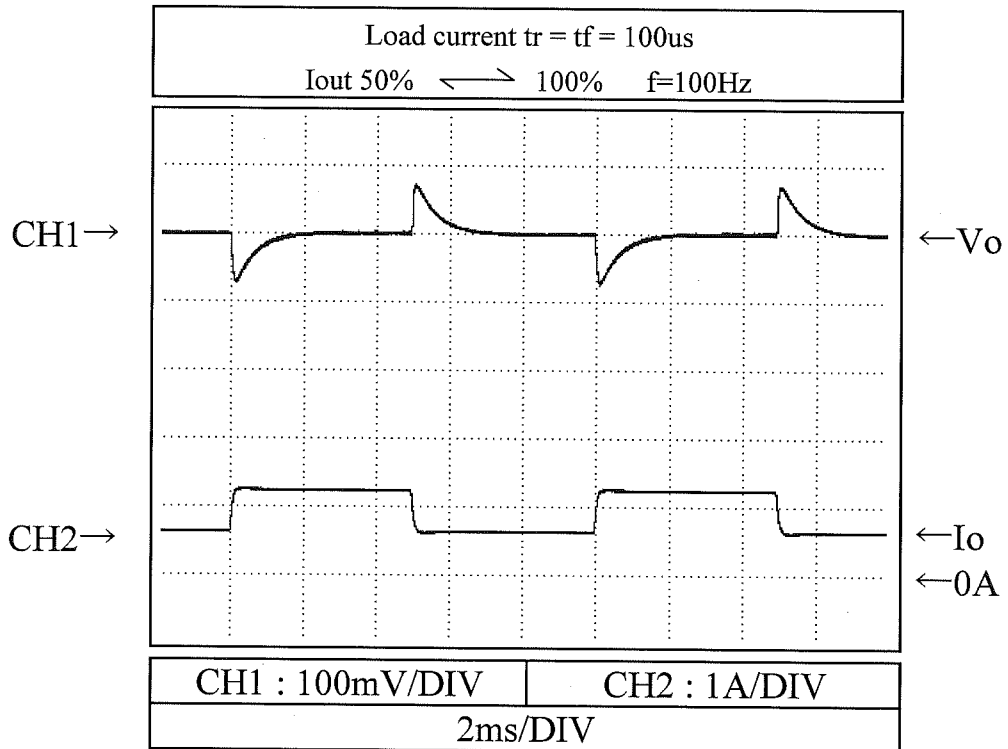

2.8 過渡応答（負荷急変）特性  
 Dynamic load response characteristics

Conditions  $V_{in}$  : 24 VDC  
 $T_a$  : 25 °C

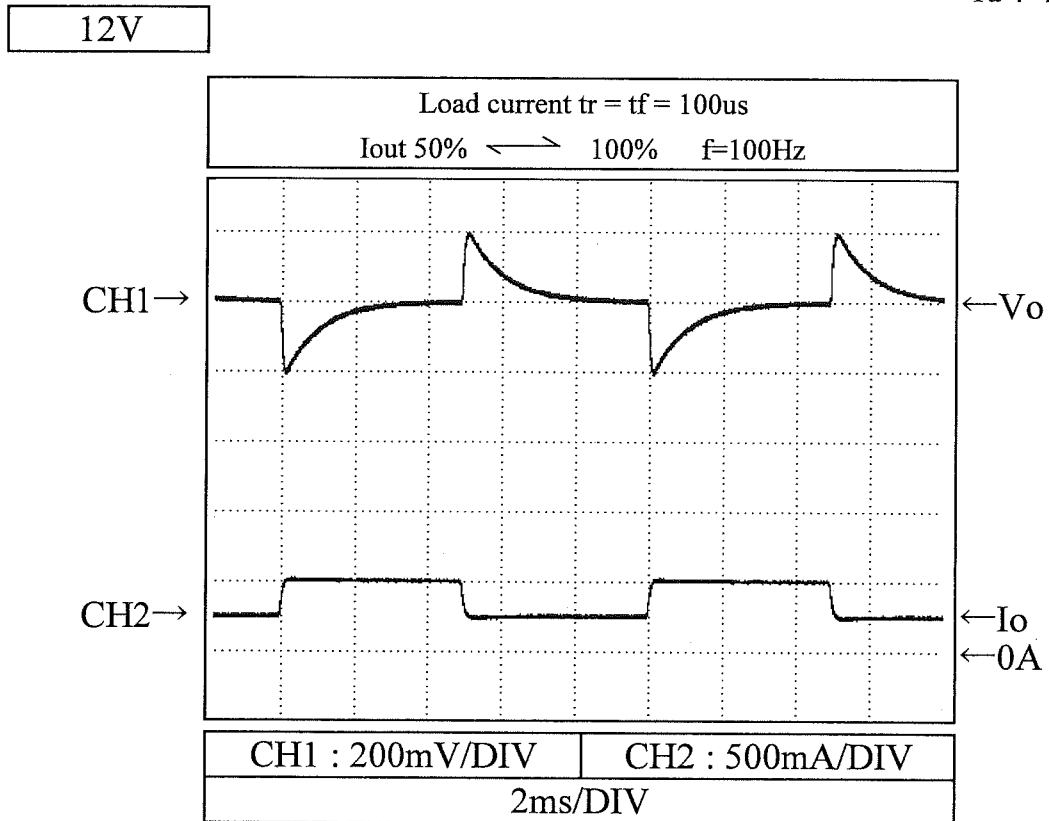

2.9 入力サージ電流（突入電流）特性  
Inrush current waveform

Conditions  $V_{in}$  : 36 VDC  
 $I_{out}$  : 100 %  
 $T_a$  : 25 °C

5V

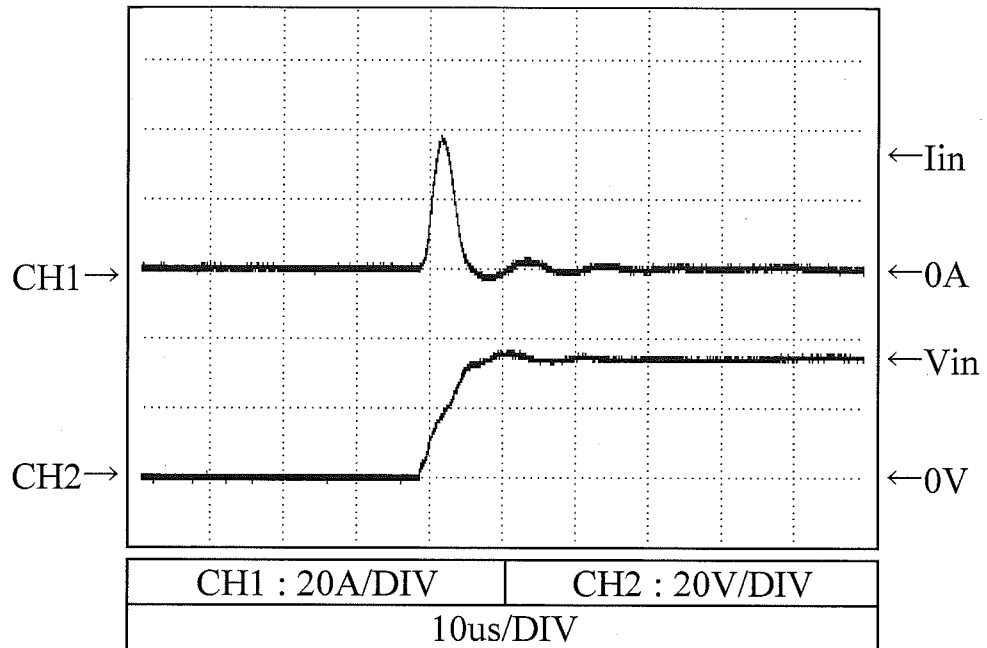

2.10 出力リップル、ノイズ波形  
Output ripple and noise waveform

Conditions Vin : 24 VDC  
Iout : 100 %  
Ta : 25 °C

3.3V

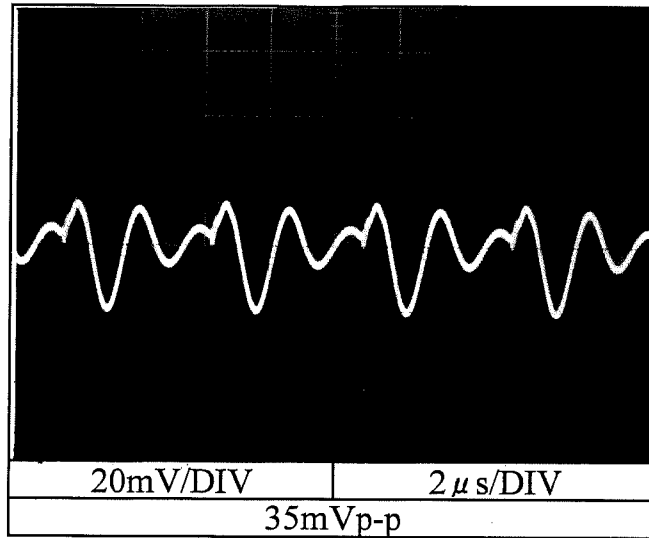

5V

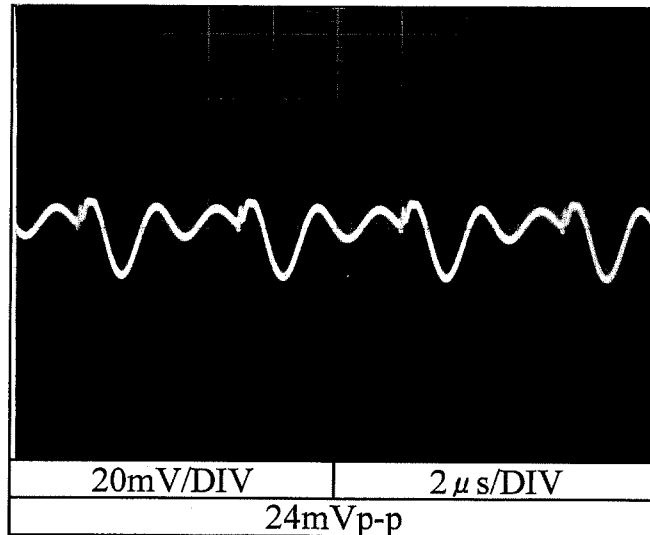

12V

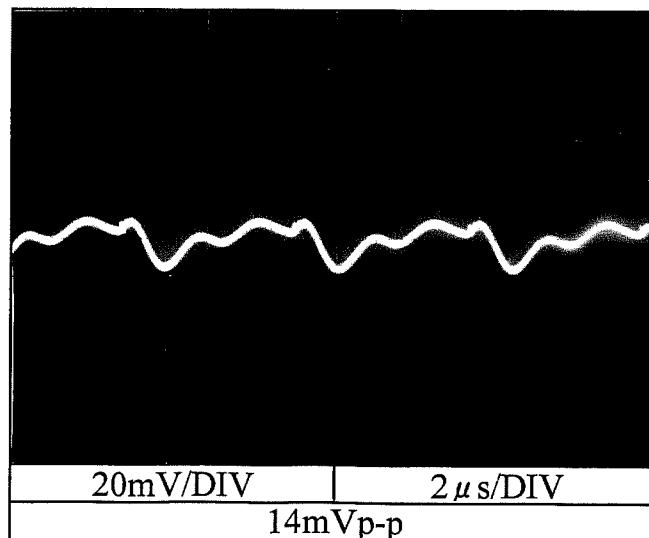



2.11 スイッチング周波数対出力電力  
Switching frequency v.s. output power

Conditions Vin : 18 VDC -----  
 24 VDC - - - - -  
 36 VDC ————  
 Ta : 25 °C

**3.3V**

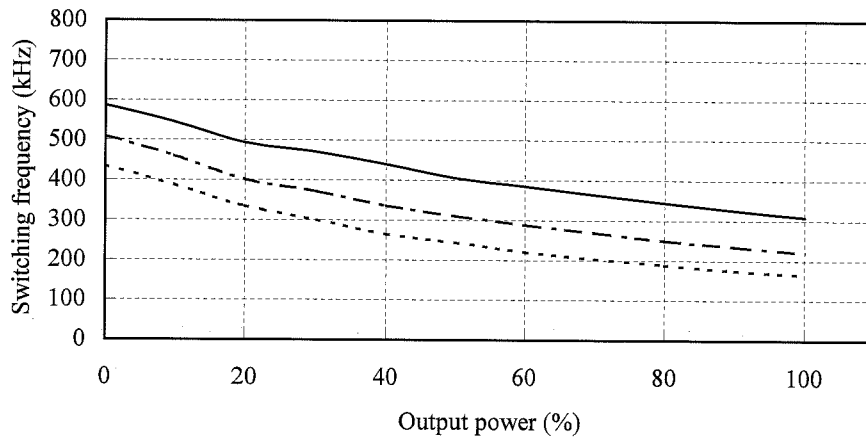

**5V**

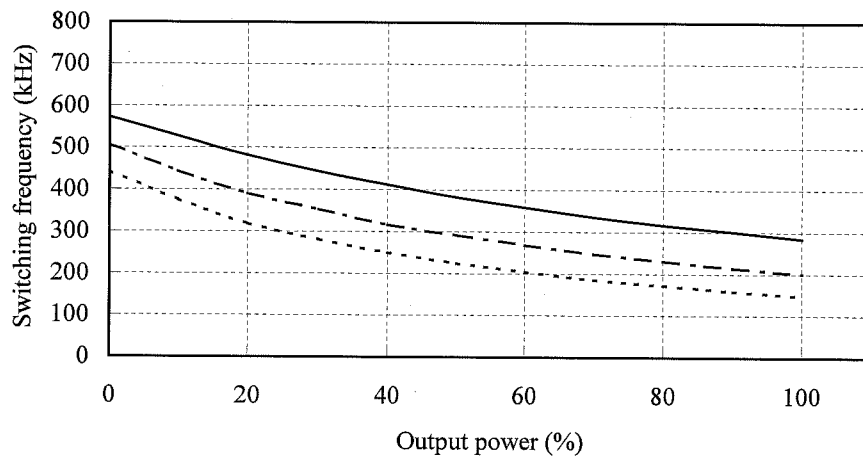

**12V**

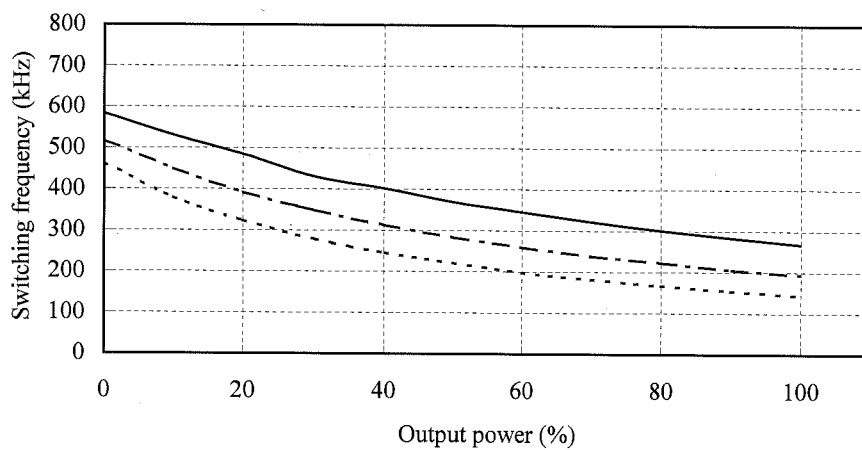

2.12 EMI特性

Electro-Magnetic Interference characteristics

(a) 雑音端子電圧 (帰還ノイズ)

Conducted Emission

VCCI class A 対応アプリケーションシステム

VCCI class A application system

Conditions Vin : 24 VDC

Iout : 100 %

Ta : 25 °C

5V

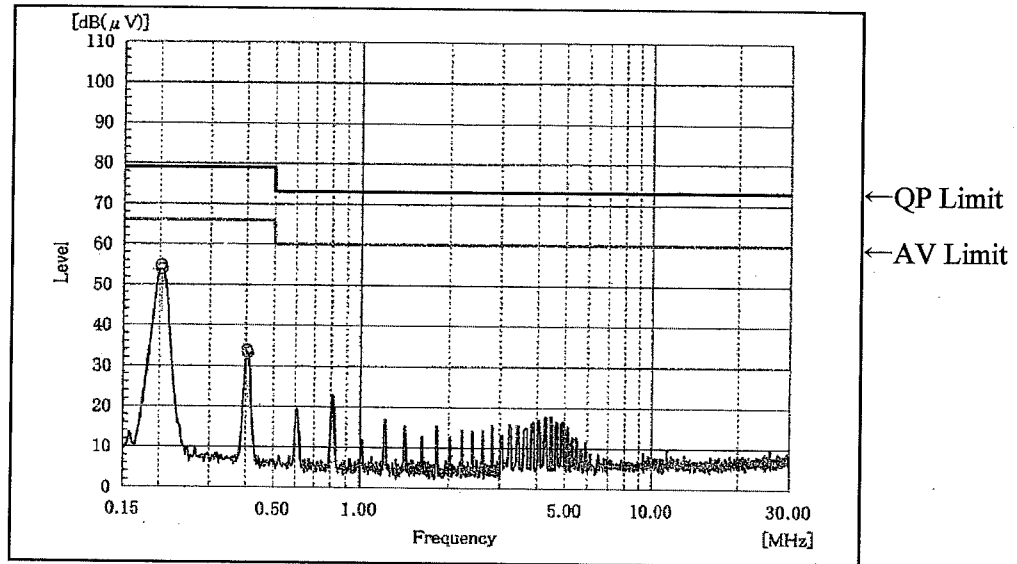

2.12 EMI特性

Electro-Magnetic Interference characteristics

(b) 雑音電界強度 (輻射ノイズ)

Radiated Emission

VCCI class A 対応アプリケーションシステム

VCCI class A application system

Conditions Vin : 24 VDC

Iout : 100 %

Ta : 25 °C

5V

HORIZONTAL:

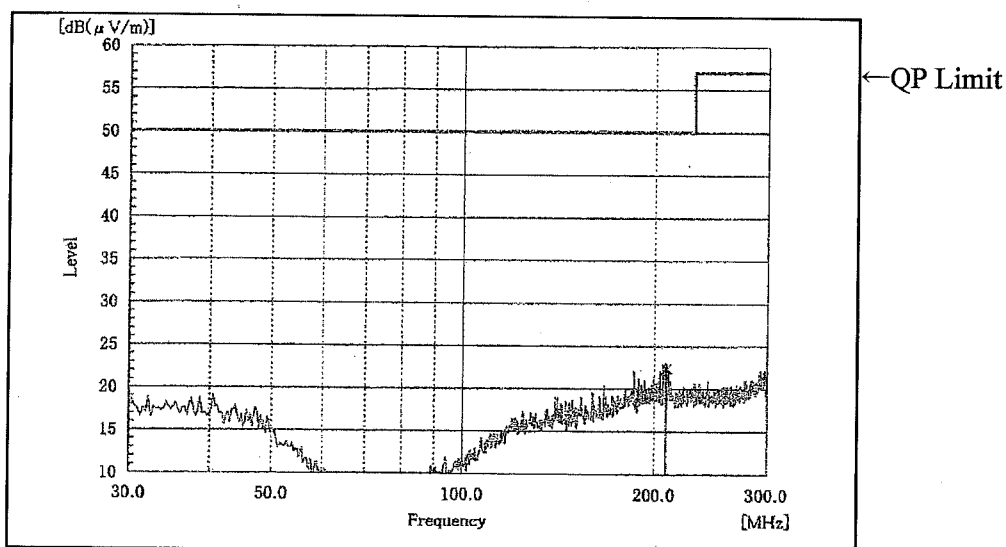

VERTICAL:

