

CCG10-24-xxD

C308-01-01C

SPECIFICATIONS

MODEL		CCG10-24-12D	CCG10-24-15D
ITEMS			
INPUT			
Input Voltage Range	VDC	9 - 36	
Efficiency (Typ) (*1)	%	89	90
Input Current (Typ) (*1)	A	0.472	0.472
OUTPUT			
Nominal Output Voltage	VDC	±12	±15
Output Voltage Accuracy (*1)	%	±2	
Maximum Output Current	A	0.42	0.34
Maximum Output Power	W	10.08	10.2
Maximum Line Regulation (*2)	mV	60	75
Maximum Load Regulation (*3)	mV	120	150
Maximum Load Regulation (*10)	mV	480	600
Temperature Coefficient	-	0.02%/°C	
Maximum Ripple & Noise (*4)	mV	120	120
Output Voltage Range	-	Fixed	
Over Current Protection (*5)	-	105% min.	
Over Voltage Protection	-	None	
FUNCTION			
Remote ON/OFF Control (*6)	-	Possible	
Remote Sensing	-	None	
Parallel Operation	-	None	
Series Operation (*6)	-	Possible	
ENVIRONMENT			
Operating Temperature (*7)	-	-40°C - +90°C	
Storage Temperature	-	-55°C - +125°C	
Operating Humidity	-	5 - 95%RH (Non Condensing)	
Storage Humidity	-	5 - 95%RH (Non Condensing)	
Vibration (*8)	-	At No Operating, 10 - 55Hz (Sweep for 1min.) Amplitude 1.65 mm Constant (Maximum 98m/s ²), X,Y,Z 1 hour each	
Shock (*8)	-	490.3m/s ²	
Cooling	-	Convection Cooling / Forced Air Cooling	
ISOLATION			
Withstand Voltage (*9)	-	Input - Output : 1.5kVDC (20mA) 1min. or 1.0kVAC (20mA) 1min.	
Isolation Resistance	-	More than 100MΩ at 25°C and 70%RH, Input - Output 500VDC	
STANDARD AND COMPLIANCE			
Safety	-	Approved by IEC/EN/UL/CSA62368-1 (Altitude ≤ 5,000m)	
MECHANICAL			
Weight (Typ.)	g	4	
Size (W x H x D)	mm	DIP : 19.0 x 11.5 x 12.4 / SMD : 19.0 x 11.8 x 12.4 (Refer to Outline Drawing)	

*Read Instruction Manual carefully, before using the power supply unit.

=NOTES=

*1. At 24VDC input voltage and maximum output current. (Ambient Temperature = +25°C.)

*2. 9 - 36VDC input voltage, constant load.

*3. No Load - Full Load, constant input voltage. (Balanced load)

*4. External components are needed for operation. (Refer to Instruction Manual.)

*5. OCP TYPE : Hiccup, Automatic recovery.

*6. Refer to Instruction Manual.

*7. Rating - Refer to Derating Curve in Instruction Manual.

*8. The result is evaluated by TDK-Lambda standard measurement conditions.

The final equipment should be evaluated to meet its requirements.

*9. This specification applies to power supply module as stand-alone.

*10. One side fixed Full Load, the other side 20% - Full Load, Constant input voltage. (Asymmetrical load)

CCG10-24-xxD

C308-01-02

BASIC CONNECTION

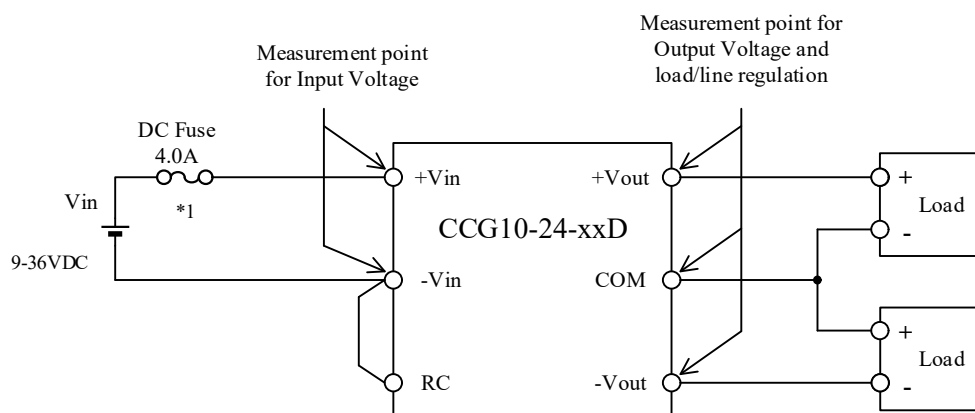

*Read instruction manual carefully, before using the power supply unit.

==NOTES==

*1. Use an external DC fuse for each unit.