



## DDA Series DC/DC DIN Mount Power Modules

Single and Dual Output  
9-53V Input, 250W, 325W, 500W

DDA DIN mountable power supplies perform local voltage conversion from a 12V, 24V, or well-regulated 48V bus. The non-isolated design allows for ultra-high efficiency and high output power ratings. The series offers both single and dual outputs featuring a wide output voltage adjustment and both positive and negative output voltage polarities. The DDA series provides an ideal solution for constructing a system requiring numerous output voltages when powered from a safety isolated AC-DC or DC-DC front end.

### Features

- Size – 123.4mm x 115 mm x 36.5 mm (4.86 in. x 4.53 in. x 1.44 in.)
- Up to 250W of output power per channel
- Wide output voltage adjustment range
- High efficiency, non-isolated design
- Remote On/Off (Negative Logic)
- Optimized dynamic voltage response
- Low input and output noise, designed to meet CISPR32-A conducted and radiated emission requirements
- Supports CISPR32-B conducted emissions in many loading configurations
- Robust design meets IEC61000-4 requirements for conducted, radiated and magnetic field immunity
- Constant switching frequency
- Remote Sense and Power Good
- Full, auto-recovery protection:
  - Input under voltage
  - Short circuit
  - Thermal limit
- DIN Rail TS-35/7.5 or TS-35/15 mounting
- UL/CSA/IEC 62368-1 Approval

## Ordering Information:

Product Identifier	Package Size	Platform	Output Power (W)	Isolation		Outputs	Polarity		Preset Output Vo1	Preset Output Vo2		Optional Feature Code
<b>D</b>	<b>D</b>	<b>A</b>	<b>325</b>	<b>N</b>	-	<b>S1</b>	<b>PX</b>	-	<b>12</b>	<b>12</b>	-	<b>001</b>
TDK-Lambda – DIN rail	123 x 115 mm	DDA	250 325 500	N - non-isolated  I – Isolated		S1 – single  D2 - Dual	PX – Positive single output  PN – dual one positive, one negative output  PP – dual both positive output		12 – 12V	05 – 5V 12 – 12V  No character for single outputs		-001 = standard, RoHS 6 Compliant

## Option Table:

Feature Set	Negative Logic On/Off
-001	Yes

## Product Offering:

PART NUMBER	INPUT VOLTAGE	OUTPUT VOLTAGE 1		OUTPUT VOLTAGE 2		MAXIMUM OUTPUT CURRENT	MAXIMUM OUTPUT POWER
		Nominal	Adjust Range	Nominal	Adjust Range		
DDA250N-S1PX-12-001	9 – 53V	12V	3.3 to 15V	NA	NA	20A / NA	250W / NA
DDA500N-D2PP-1205-001	9 – 53V	12V	3.3 to 15V	5V	3.3 to 15V	20A / 20A	250W / 250W
DDA325N-D2PN-1212-001	9 – 40V	12V	3.3 to 24V	-12V	-3.3 to -24V	14A / 8A	250W / 75W

Consult factory for other output voltage combinations.

## Mechanical Specification:

### FRONT PANEL



### TOP SIDE

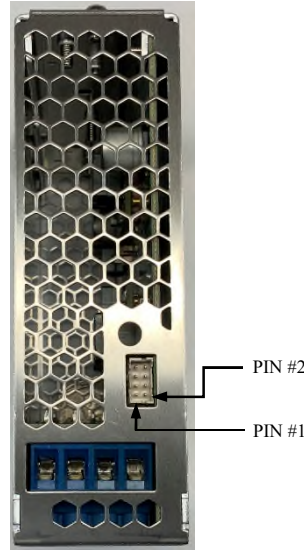

### TOP SIDE CONNECTOR

	Part Number	Vendor
Top Side Signal Header Connector	S8B-PHDSS(LF)(SN)	JST

### Recommended Mating Connector

	Part Number	Vendor
Housing	PHDR-8VS	JST
Terminal Pins	SPHD-002T-P0.5 or SPHD-001T-P0.5	JST

PIN	FUNCTION	DESCRIPTION
1	Vo1 SENSE (+)	Remote Sense for Output 1
2	Vo2 SENSE (+)	Remote Sense for Output 2
3	Sync Signal	DO NOT CONNECT
4	Signal GND	Ground
5	Vo1 PWR GOOD	Power Good Signal, Output 1
6	Vo2 PWR GOOD	Power Good Signal, Output 2
7	CC Ref	Constant Current ( <i>Consult Technical Support</i> )
8	Signal GND	Ground

TERMINAL	FUNCTION	DESCRIPTION	RECOMMENDED †	MAX TORQUE *
1	Vo2 (-)	Output 2 (-)	10 – 16 AWG	0.5 Nm
2	Vo2 (+)	Output 2 (+)	10 – 16 AWG	0.5 Nm
3	Vo1 (-)	Output 1 (-)	10 – 16 AWG	0.5 Nm
4	Vo1	Output 1 (+)	10 – 16 AWG	0.5 Nm
5	On/Off Vo2	Remote On/Off (Output 2)	10 – 24 AWG	0.5 Nm
6	On/Off Vo1	Remote On/Off (Output 1)	10 – 24 AWG	0.5 Nm
7	VIN (-)	Input (-)	10 – 16 AWG	0.5 Nm
8	VIN (+)	Input (+)	10 – 16 AWG	0.5 Nm

† Ensure rated for voltage and current

\* 4.4 lbf.in

Note: According to EN/UL60950-1 multi-strand flexible cables connected to the input require a ferrule.

## Mechanical Specification:

Dimensions are in mm. Unless otherwise specified tolerances are:  $x.x \pm 0.5$   
 Max Weight: 450 grams

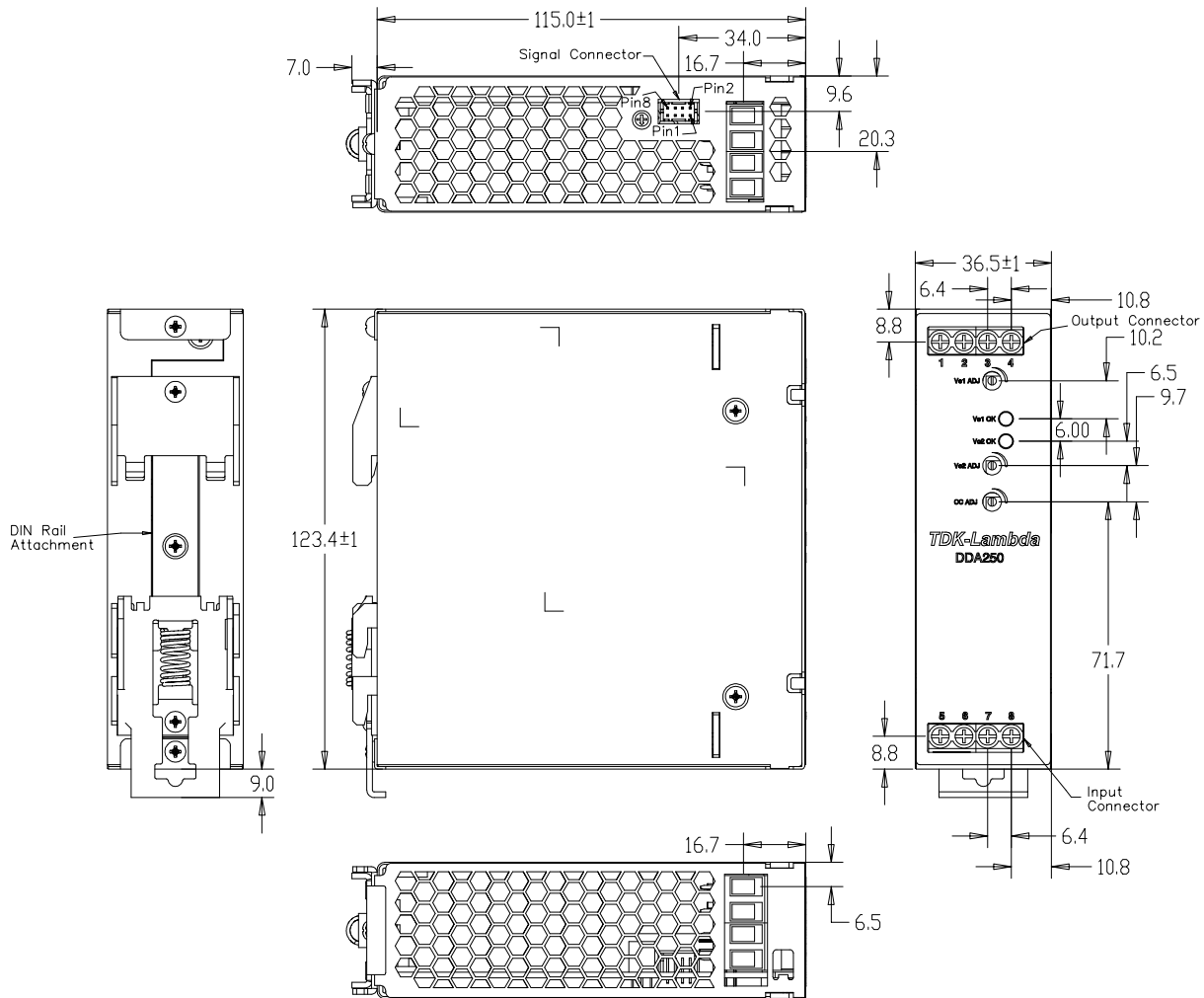

## Absolute Maximum Ratings:

Stress in excess of Absolute Maximum Ratings may cause permanent damage to the device.

Characteristic	Min	Max	Unit	Notes & Conditions
Continuous Input Voltage	-0.25	55	Vdc	Products with 53 Vdc maximum input
	-0.25	50	Vdc	Products with 40 Vdc maximum input
Isolation Voltage	---	---	Vdc	None (codes with N option)
Storage Temperature	-55	105	°C	
Operating Temperature Range (Tamb)	-40	100	°C	Refer to derating curve in the thermal performance section of the data sheet.

## Input Characteristics:

Unless otherwise specified, specifications apply over all rated Input Voltage, Resistive Load, and Temperature conditions.

Characteristic	Min	Typ	Max	Unit	Notes & Conditions
Operating Input Voltage	10	---	53	Vdc	Vin > Vo, refer to product offering table
	10	---	40	Vdc	Vin > Vo refer to product offering table
Maximum Input Current	250W	---	20	A	Vin = Vin,min to Vin,max; Io=Io,max
	325W	---	35	A	Vin = Vin,min to Vin,max; Io=Io,max
	500W	---	40	A	Vin = Vin,min to Vin,max; Io=Io,max
Standby input power	250W	---	4	mA	Vin = 24V, On/Off = Off
	325W	---	6	mA	Vin = 24V, On/Off = Off
	500W	---	8	mA	Vin = 24V, On/Off = Off
Startup Delay Time from application of input voltage	---	4	---	ms	Vo=0 to 0.1*Vo,set; On/Off=On, Io=Io,max, Tc=25 °C
Startup Delay Time from On/Off	---	3	---	ms	Vo=0 to 0.1*Vo,set; Vin=Vi,nom, Io=Io,max, Tc=25 °C
Output Voltage Rise Time	---	10	---	ms	Io=Io,max, Tc=25 °C, Vo=0.1 to 0.9*Vo,set
Turn on input voltage	---	8	---	V	
Turn off input voltage	---	7	---	V	

## Electrical Data: DDA250N-S1PX-12-001

Characteristic	Min	Typ	Max	Unit	Notes & Conditions
Nominal Output Voltage	---	12	---	V	
Output Voltage Adjustment Range	3.3	---	15	V	Voltage step down only
Efficiency $V_o = 5V$	---	92	---	%	$V_{in}=12V$ ; $I_o=I_{o,max}$ ; $T_c=25^\circ C$
Efficiency $V_o = 12V$	---	95	---	%	$V_{in}=24V$ ; $I_o=I_{o,max}$ ; $T_c=25^\circ C$
Efficiency $V_o = 12V$	---	93	---	%	$V_{in}=48V$ ; $I_o=I_{o,max}$ ; $T_c=25^\circ C$
Line Regulation	---	25	---	mV	$V_{in}=V_{in,min}$ to $V_{in,max}$
Load Regulation	---	150	---	mV	$I_o=I_{o,min}$ to $I_{o,max}$
Maximum Output Current	---	---	20	A	Observe maximum power limit and thermal derating
Output Current Limiting Threshold	---	28	---	A	$V_o = 0.9 \cdot V_{o,nom}$ , $T_c < T_{c,max}$
Short Circuit Current	---	0.5	---	A	$V_o = 0.25V$ , $T_c = 25^\circ C$
Output Ripple and Noise Voltage	---	60	---	mVpp	Measured at output terminal, BW = 20MHz, $V_{in} = 24V$ , $V_o = 12V$ , $I_o=full$ load
Output Voltage Sense Range	---	---	5	%	
Dynamic Response: Recovery Time	---	70	---	$\mu s$	$di/dt = 1A/\mu s$ , $V_{in}=V_{in,nom}$ ; $V_o=12V$ , load step from 25% to 75% of $I_{o,max}$ .
Transient Voltage	---	600	---	mV	
Switching Frequency	---	400	---	kHz	Fixed
External Load Capacitance	0	---	1000*	$\mu F$	

\*Please contact TDK-Lambda for technical support for very low ESR capacitor banks or if higher capacitance or higher slew rates are required.

## Electrical Characteristics: DDA250N-S1PX-12-001

### Typical Efficiency vs. Input Voltage

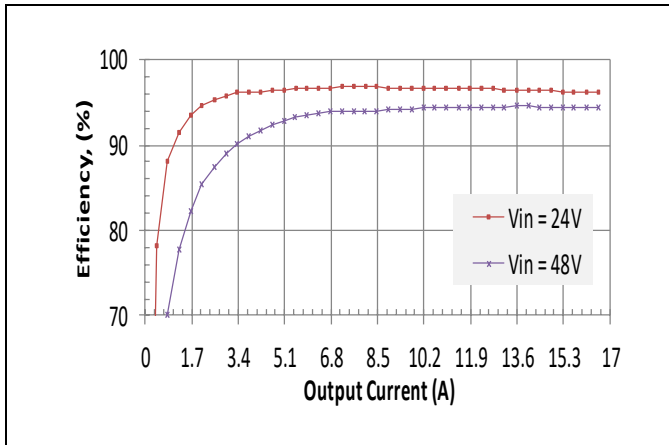

Vo = 15V

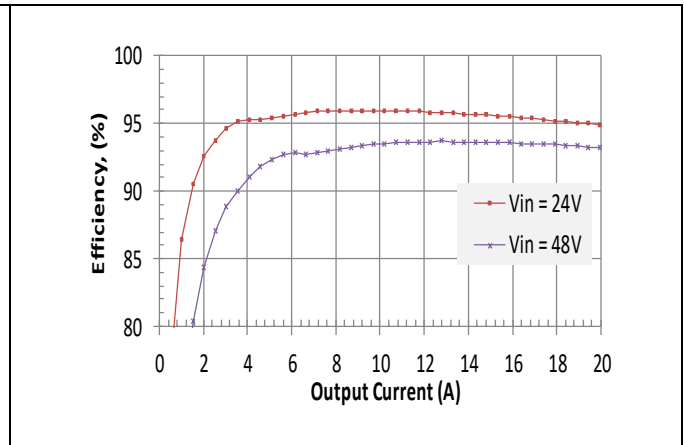

Vo = 12V

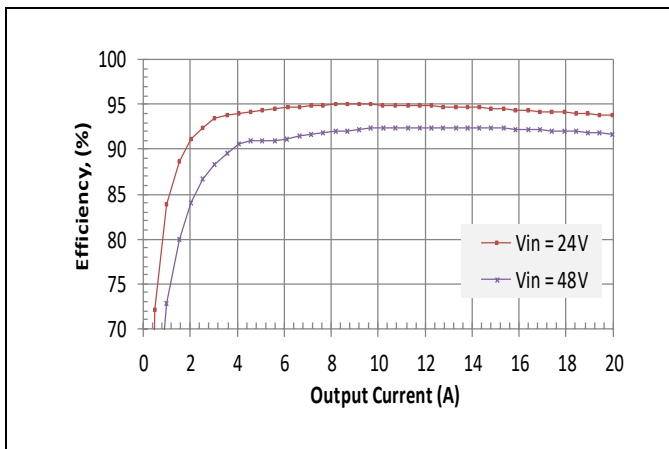

Vo = 9V

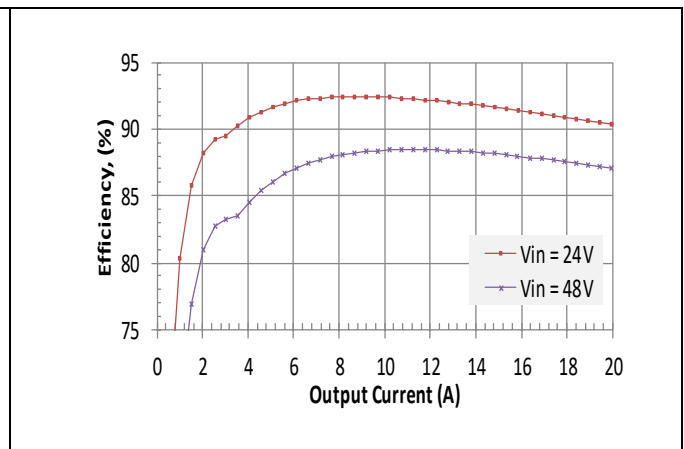

Vo = 5V

## Electrical Characteristics: DDA250N-S1PX-12-001

### Typical Power Dissipation vs. Input Voltage

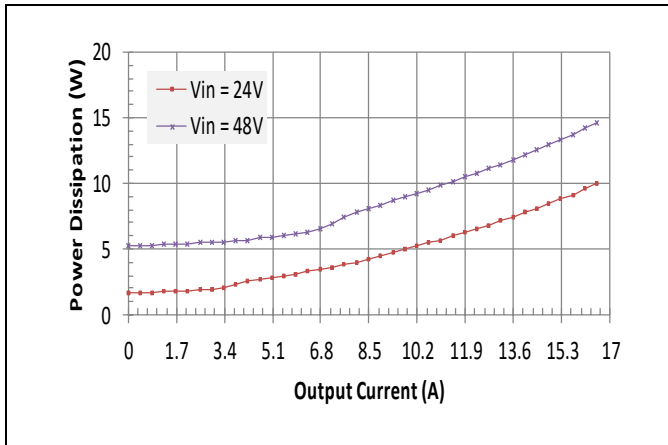

Vo = 15V

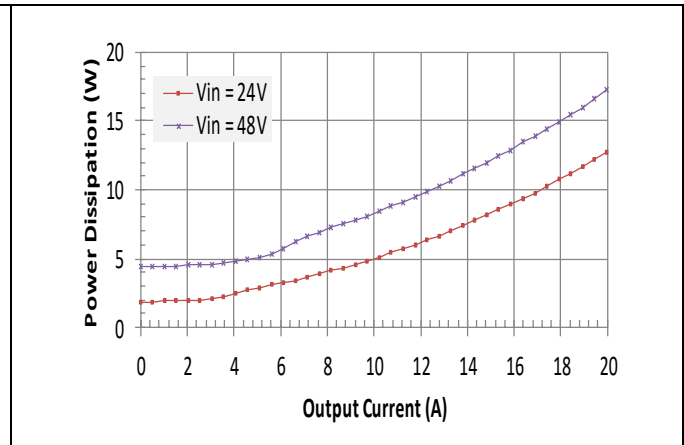

Vo = 12V

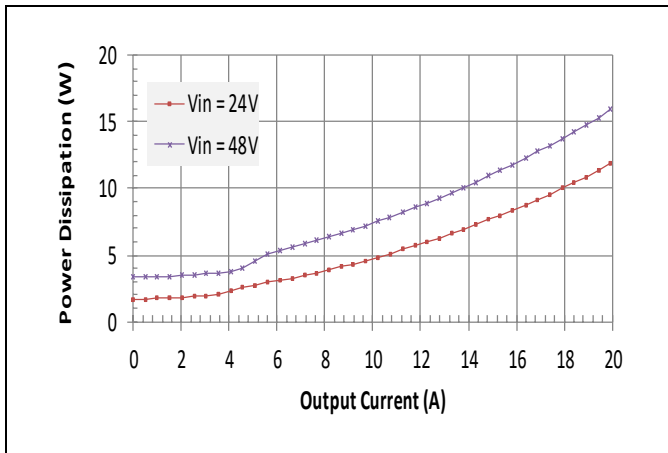

Vo = 9V

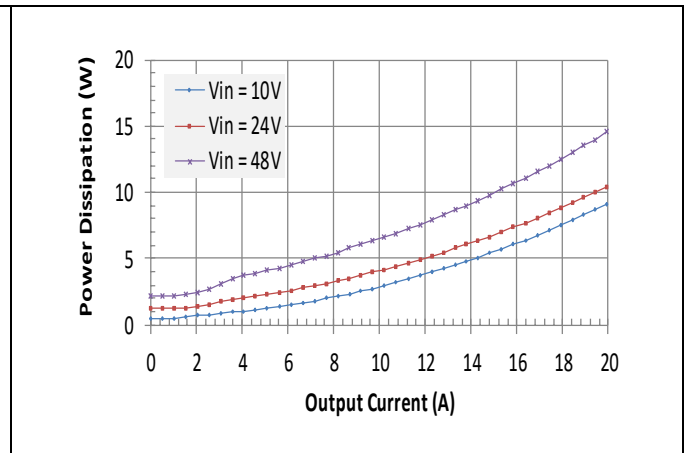

Vo = 5V



## Electrical Characteristics: DDA250N-S1PX-12-001

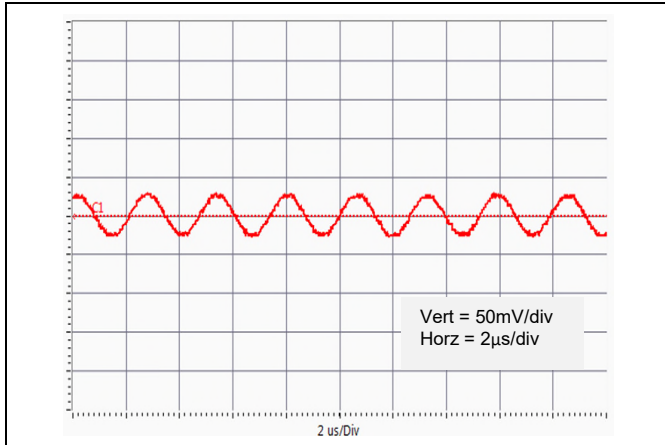

Vo = 12V Typical Output Ripple at nominal Input voltage and full load at Ta = 25 °C.

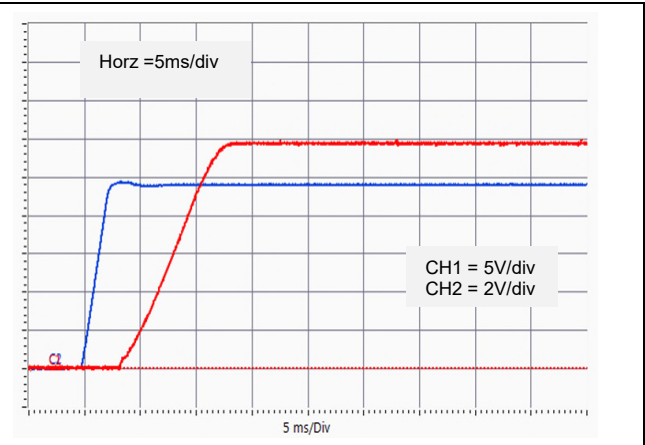

Vo = 12V Typical startup characteristic from input voltage at full load. Ch1 - input voltage, Ch2 – output voltage.

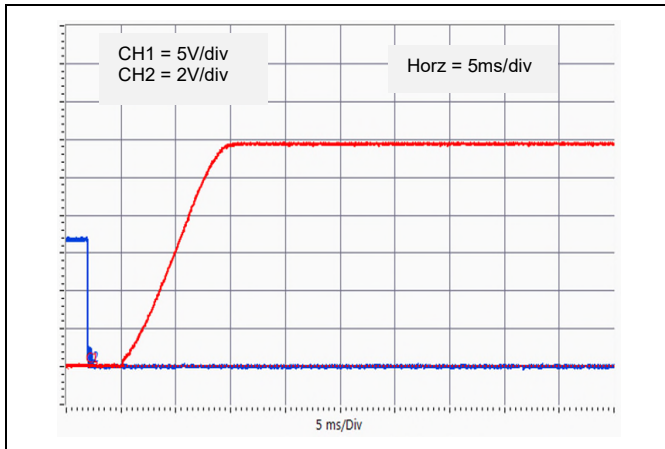

Vo = 12V Typical startup characteristic from On/Off at full load. Ch1 - output voltage, Ch2 – On/Off signal.

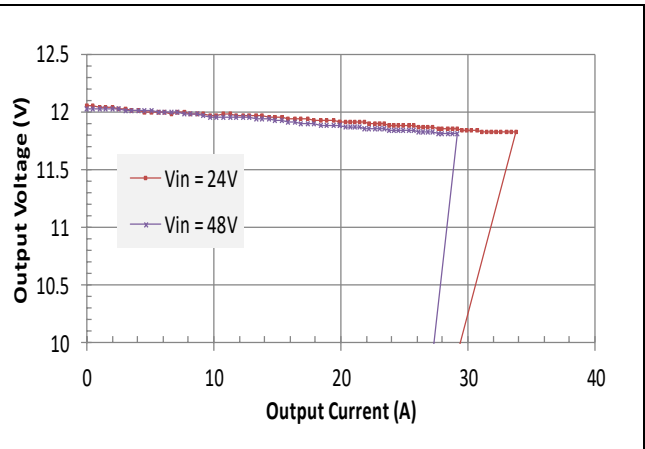

Vo = 12V Typical Current Limit Characteristics.

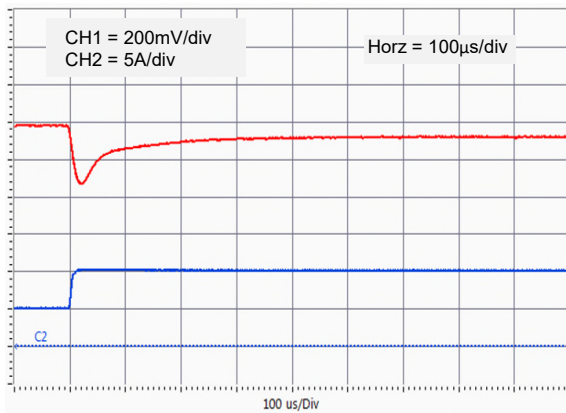

Vo = 12V Typical output voltage transient response to load step from 25% to 50% of full load with output current slew rate of 1A/µs.

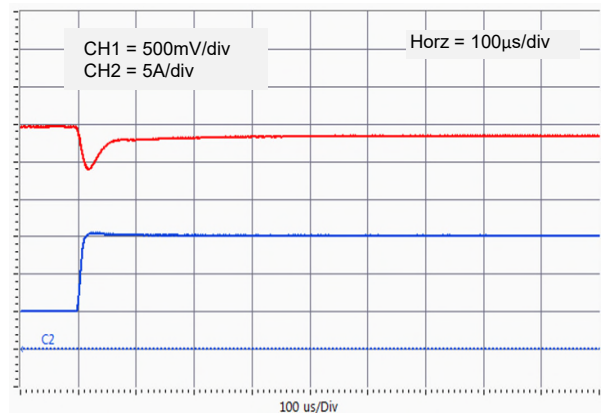

Vo = 12V Typical output voltage transient response to load step from 25% to 75% of full load with output current slew rate of 1A/µs.

## Electrical Characteristics: DDA250N-S1PX-12-001

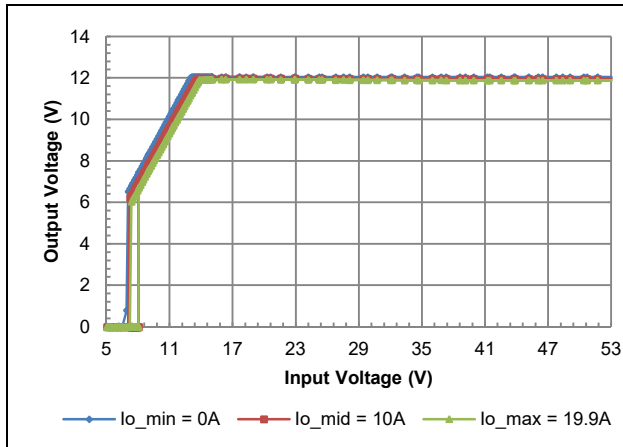

Vo = 12V Typical Output Voltage vs. Input Voltage Characteristics.

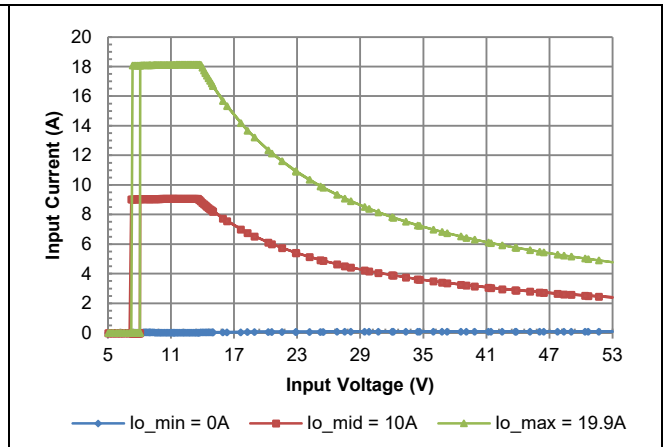

Vo = 12V Typical Input Current vs. Input Voltage Characteristics.

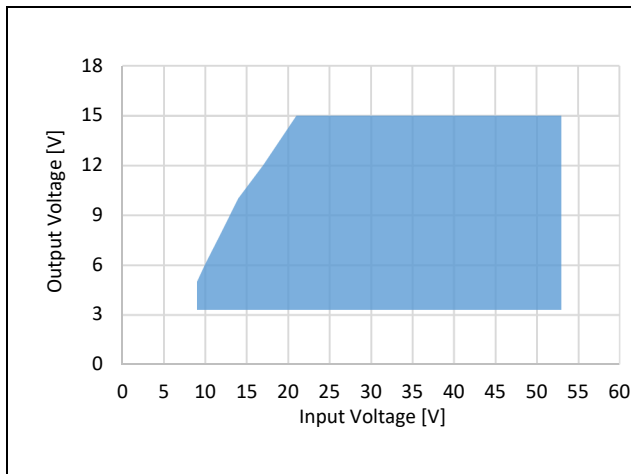

Output Voltage vs. Input Voltage Operating Range.

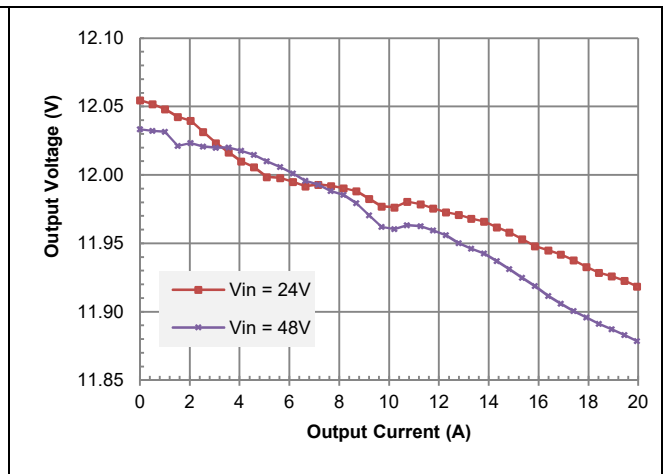

Vo = 12V Typical load regulation.

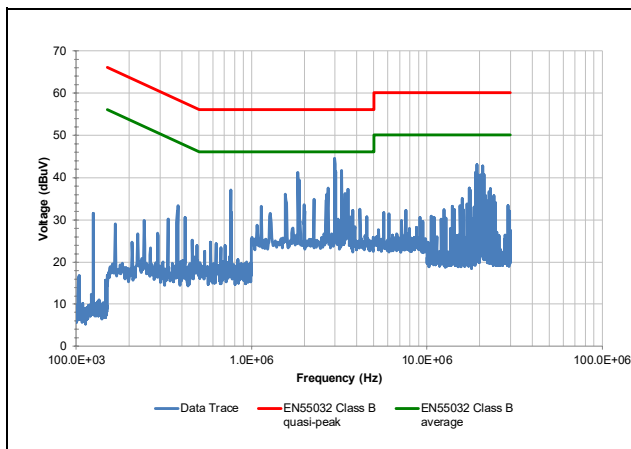

Typical Conducted Emissions  $V_{in} = 24V$ ,  $V_o = 5V$ , full load.

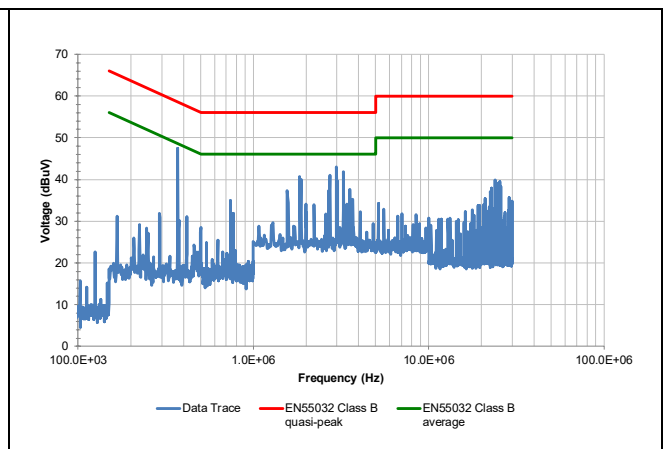

Typical Conducted Emissions  $V_{in} = 53V$ ,  $V_o = 12V$ , full load.

## Thermal Characteristics: DDA250N-S1PX-12-001

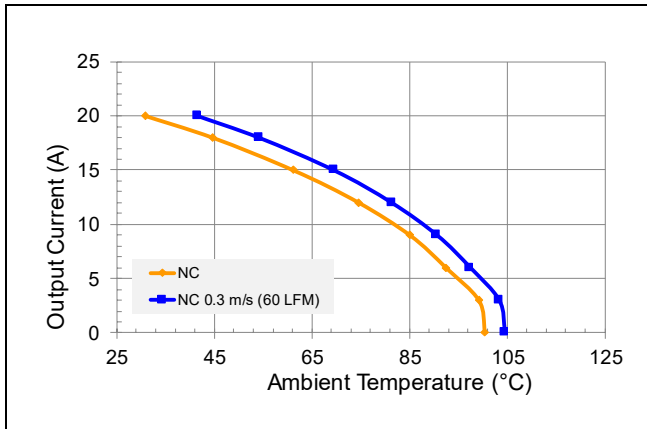

Vo = 12V, Vin = 24V maximum output current vs. ambient temperature.

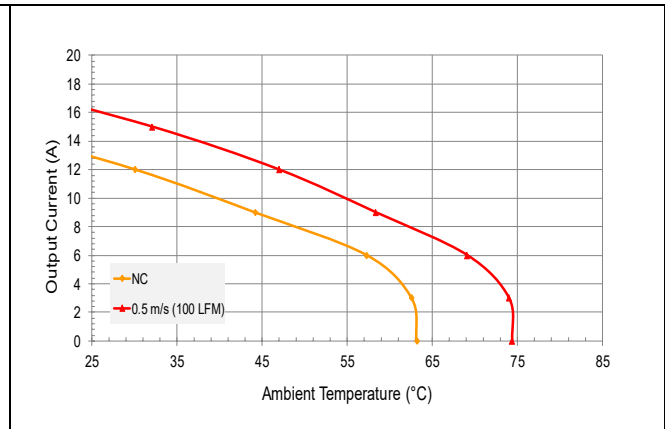

Vo = 12V, Vin = 48V maximum output current vs. ambient temperature.

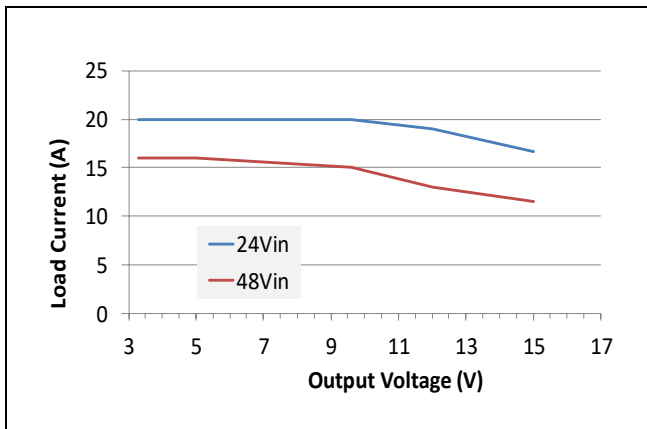

Typical load current derating versus output voltage setting at 45 °C ambient condition.

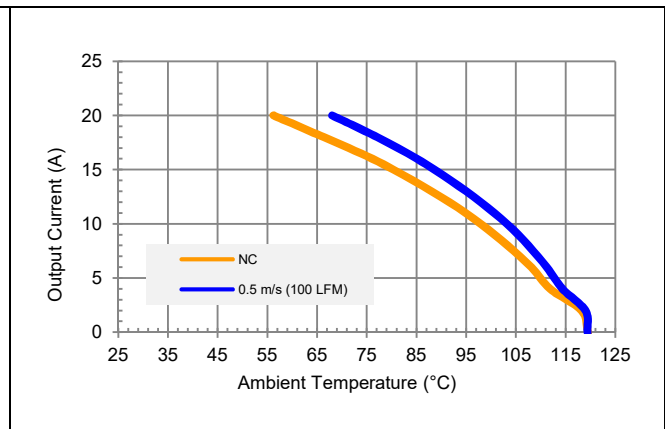

Vo = 5V, Vin = 24V maximum output current vs. ambient temperature.

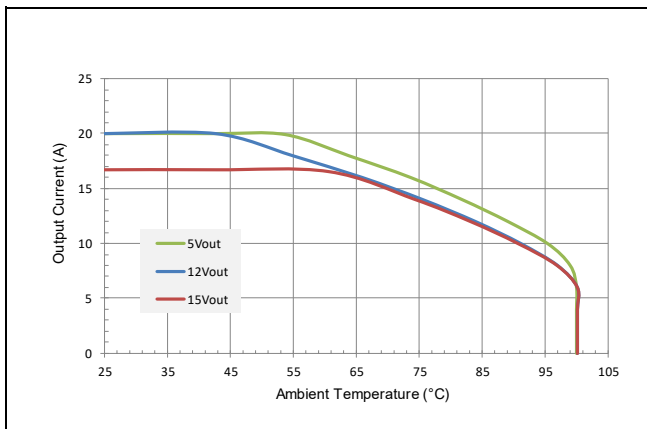

Typical output current vs. ambient temperature derating per indicated output voltage setpoints at Vin = 24 V.

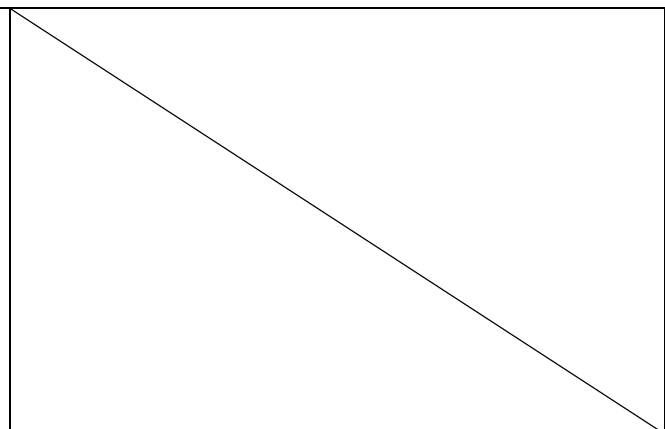

The thermal curves provided are based upon measurements made in TDK-Lambda's experimental test setup. Due to the large number of variables in system design, TDK-Lambda recommends that the user verify the module's thermal performance in the end application. TDK-Lambda can provide supplies with a thermocouple pre-mounted to the critical component for system verification tests.

## Electrical Data: DDA325N-D2PN-1212-001

Characteristic	Min	Typ	Max	Unit	Notes & Conditions
Nominal Output Voltage	---	12	---	V	Output 1
Nominal Output Voltage	---	-12	---	V	Output 2
Output Voltage Adjustment Range (Out 1)	3.3	---	24	V	Voltage step down only
Output Voltage Adjustment Range (Out 2)	-3.3	---	-24	V	To avoid possible damage maintain $V_{in} +  V_o  < 48$
Efficiency $V_{o1}= V_{o2}  = 5V$	---	88	---	%	$V_{in} = 12V$ ; $I_o = I_{o,max}$ ; $T_c = 25\text{ }^\circ\text{C}$
Efficiency $V_{o1}= V_{o2}  = 12V$	---	94	---	%	$V_{in} = 24V$ ; $I_o = I_{o,max}$ ; $T_c = 25\text{ }^\circ\text{C}$
Line Regulation	---	20	---	mV	$V_{in} = V_{in,min}$ to $V_{in,max}$
Load Regulation	---	100	---	mV	$I_o = I_{o,min}$ to $I_{o,max}$
Maximum Output Current 1	---	---	14	A	Observe maximum power limit and thermal derating.
Maximum Output Current 2	---	---	8	A	Observe maximum power limit and thermal derating.
Output Current Limiting Threshold 1	---	22	---	A	$V_o = 0.9 \cdot V_{o1,nom}$ , $T_c < T_{c,max}$
Output Current Limiting Threshold 2	---	15	---	A	$V_o = 0.9 \cdot V_{o2,nom}$ , $T_c < T_{c,max}$
Short Circuit Current	---	0.5	---	A	$V_o = 0.25V$ , $T_c = 25\text{ }^\circ\text{C}$
Output Ripple and Noise Voltage Output 1	---	50	---	mVpp	Measured at output terminal, BW = 20MHz, $V_{in} = 24V$ , $V_o = 12V$ , $I_o = \text{full load}$
Output Ripple and Noise Voltage Output 2	---	50	---	mVpp	Measured at output terminal, BW = 20MHz, $V_{in} = 24V$ , $V_o = 12V$ , $I_o = \text{Full Load}$
Output Voltage Sense Range (Out 1 & 2)	---	---	5	%	
Dynamic Response Output 1: Recovery Time	---	60	---	$\mu\text{s}$	$di/dt = 1A/\mu\text{s}^*$ , $V_{in} = V_{in,nom}$ ; $V_{o1} = 12V$ , load step from 25% to 75% of $I_{o,max}$
Transient Voltage	---	400	---	mV	
Dynamic Response Output 2: Recovery Time	---	200	---	$\mu\text{s}$	$di/dt = 1A/\mu\text{s}^*$ , $V_{in} = V_{in,nom}$ ; $V_{o2} = 12V$ , load step from 25% to 75% of $I_{o,max}$
Transient Voltage	---	200	---	mV	
Switching Frequency	---	400	---	kHz	Fixed
External Load Capacitance Output 1	0	---	1000*	$\mu\text{F}$	
External Load Capacitance Output 2	0	---	1000*	$\mu\text{F}$	Maximum capacitor varies with output voltage, $C_{max} = 1300 - (47 \times  V_{out} ) \mu\text{F}$

\* Please contact TDK-Lambda for technical support for very low ESR capacitor banks or if higher capacitance or higher slew rates are required

## Electrical Characteristics: DDA325N-D2PN-1212-001

### Typical Efficiency vs. Input Voltage

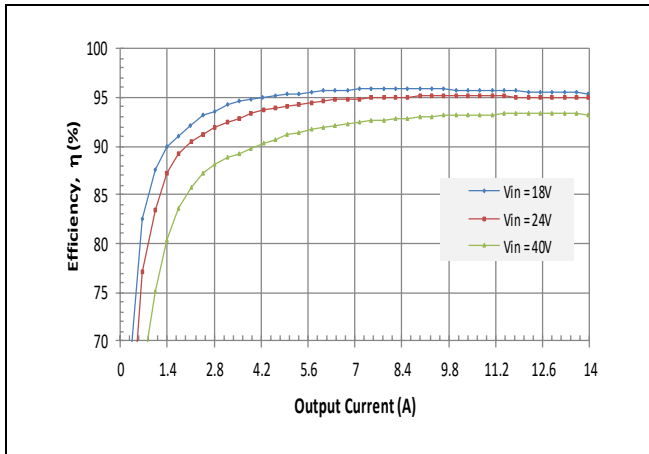

Vo1 = 12V, Io2 = 0

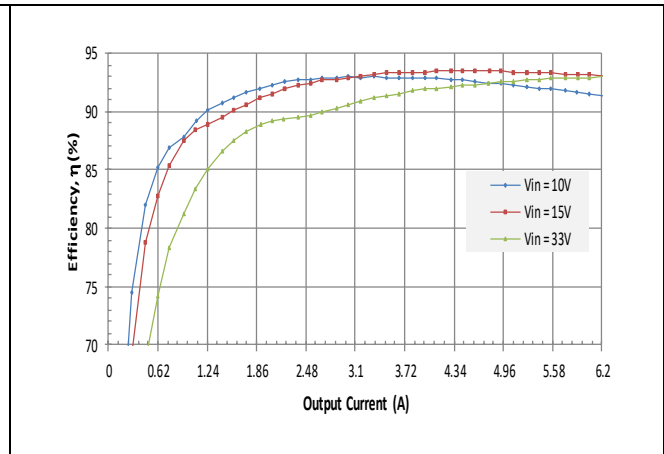

Vo2 = -12V, Io1 = 0

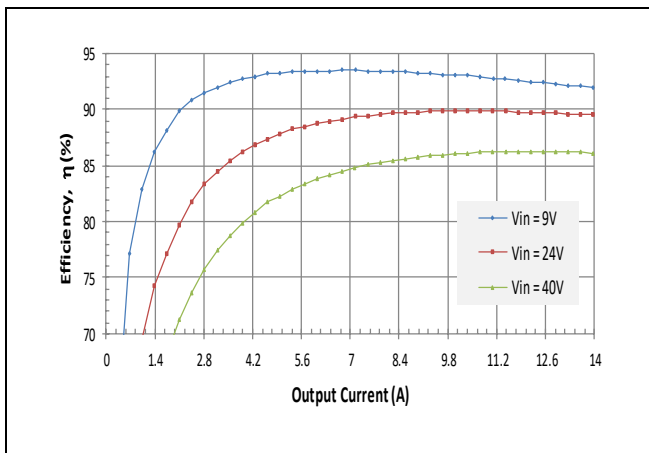

Vo1 = 5V, Io2 = 0

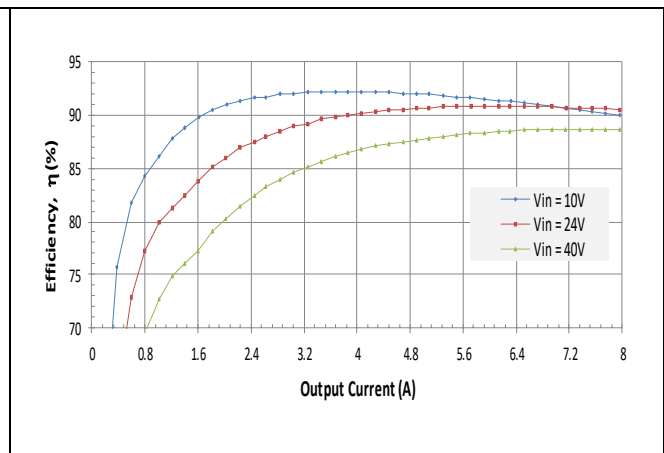

Vo2 = -5V, Io1 = 0

## Electrical Characteristics: DDA325N-D2PN-1212-001

### Typical Power Dissipation vs. Input Voltage

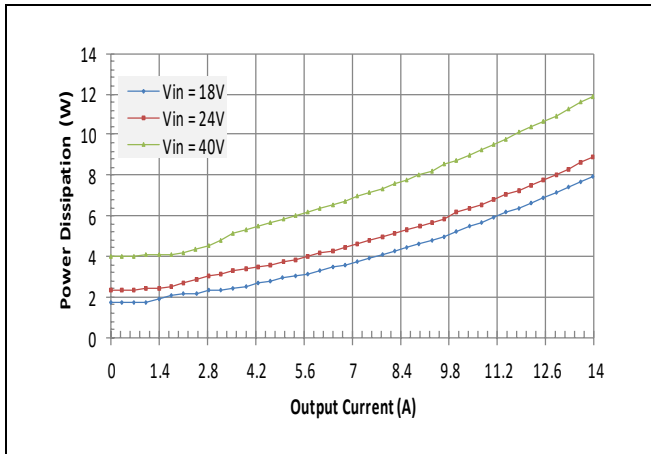

$V_{o1} = 12V, I_{o2} = 0$

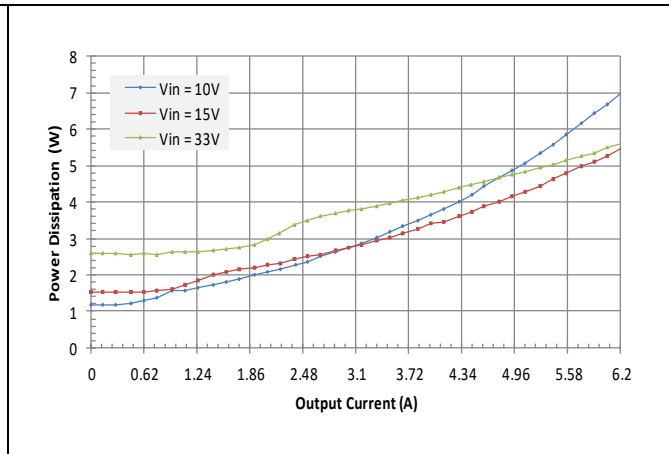

$V_{o2} = -12V, I_{o1} = 0$

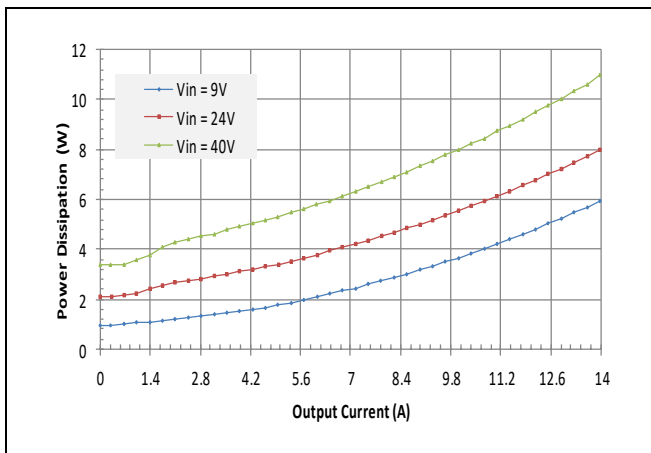

$V_{o1} = 5V, I_{o2} = 0$

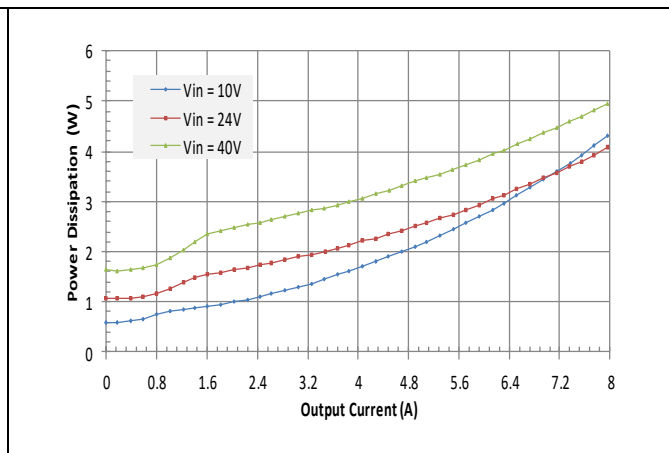

$V_{o2} = -5V, I_{o1} = 0$

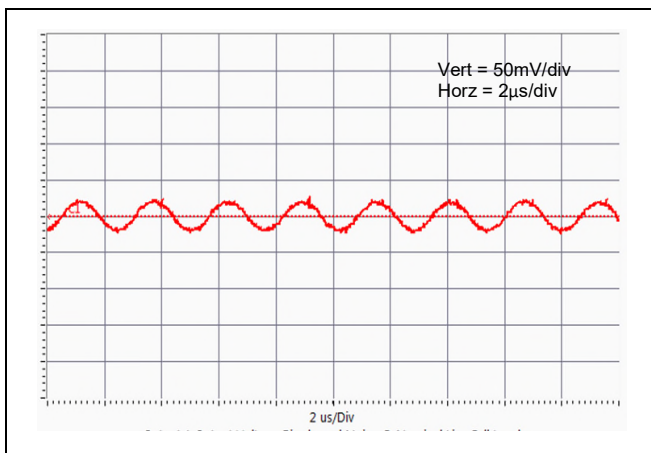

$V_{o1} = 12V$  Typical Output Ripple at nominal Input voltage and full load at  $T_a = 25^\circ C$ .

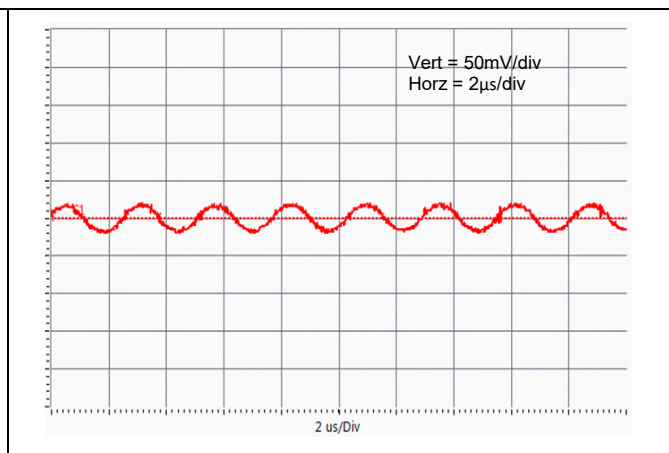

$V_{o2} = -12V$  Typical Output Ripple at nominal Input voltage and full load at  $T_a = 25^\circ C$ .

## Electrical Characteristics: DDA325N-D2PN-1212-001

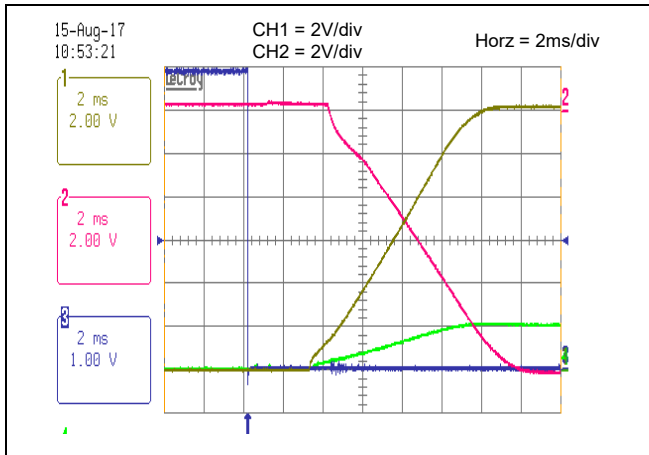

Vo = 12V Typical startup characteristic from On/Off at full load.  
Ch1, Ch2 - On/Off signal output voltage, Ch3 - On/Off signal output voltage.

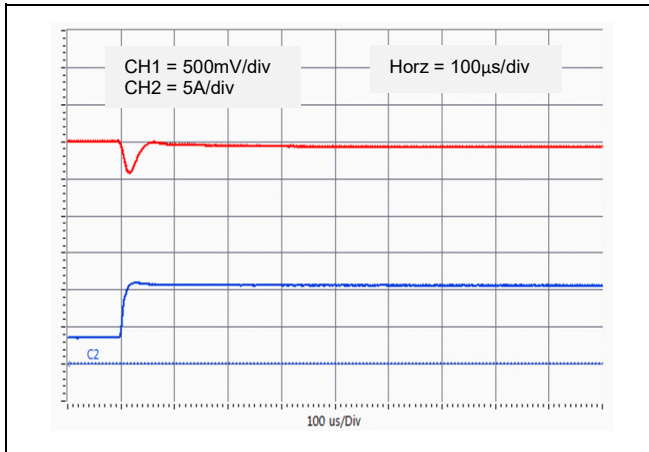
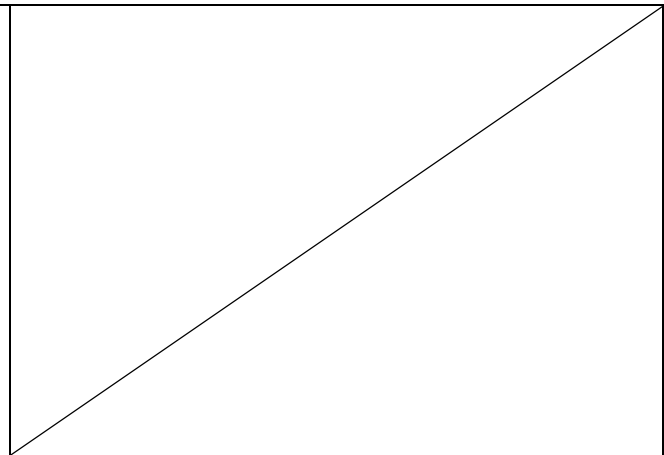

Vo1 = 12V Typical output voltage transient response to load step from 25% to 75% of full load with output current slew rate of 1A/μs.

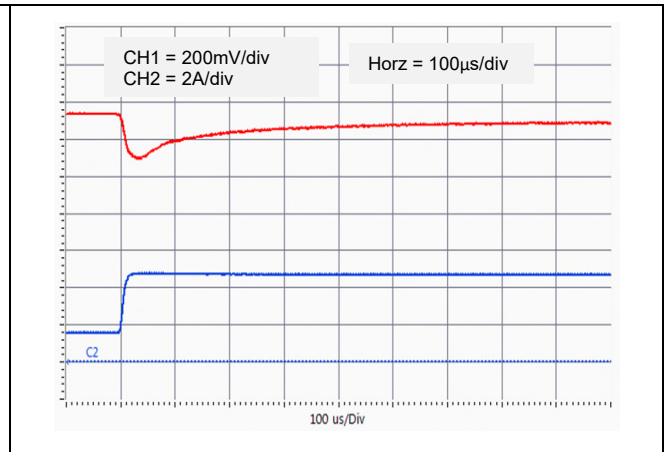

Vo2 = -12V Typical output voltage transient response to load step from 25% to 75% of full load with output current slew rate of 1A/μs.

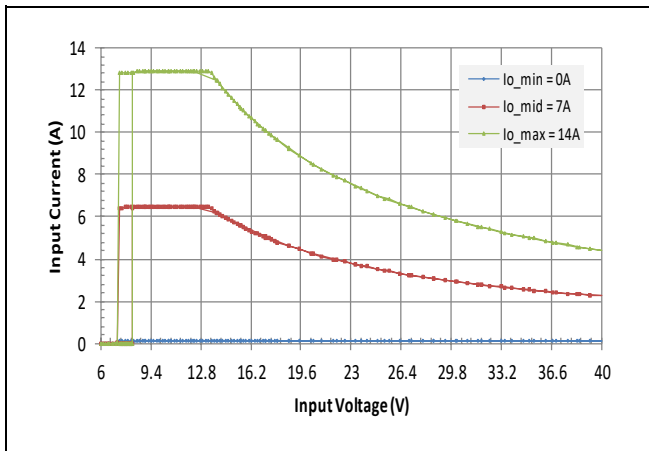

Vo1 = 12V Typical Input Current vs. Input Voltage Characteristics, Io2 = 0.

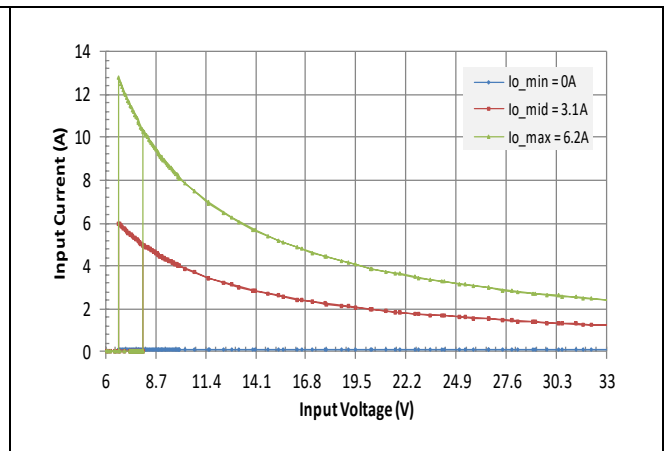

Vo2 = -12V Typical Input Current vs. Input Voltage Characteristics, Io1 = 0.

## Electrical Characteristics: DDA325N-D2PN-1212-001

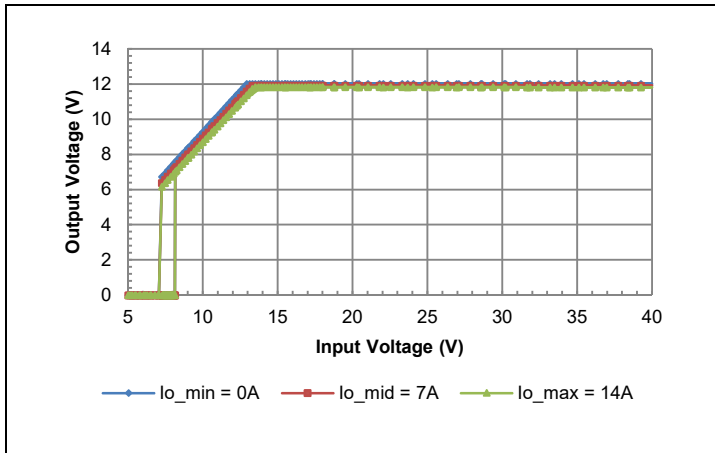

Vo1 = 12V Typical Output Voltage vs. Input Voltage Characteristics, Io2 = 0

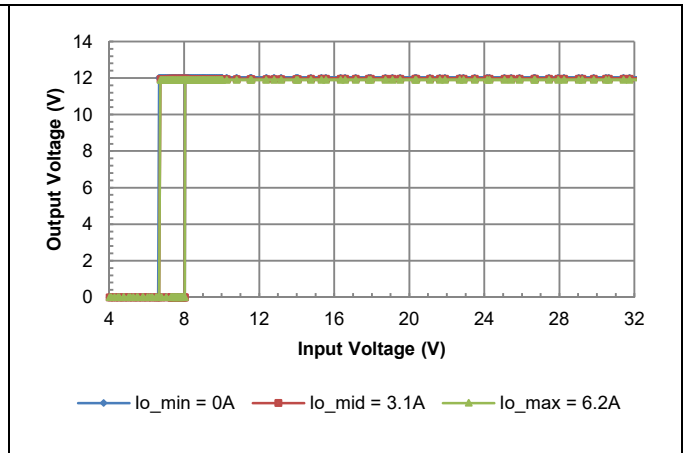

Vo2 = -12V Typical Output Voltage vs. Input Voltage Characteristics, Io1 = 0

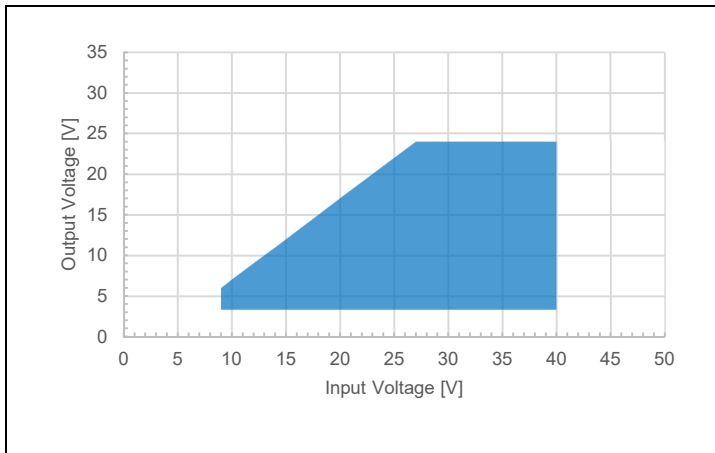

Output Voltage 1 vs. Input Voltage Operating Range.

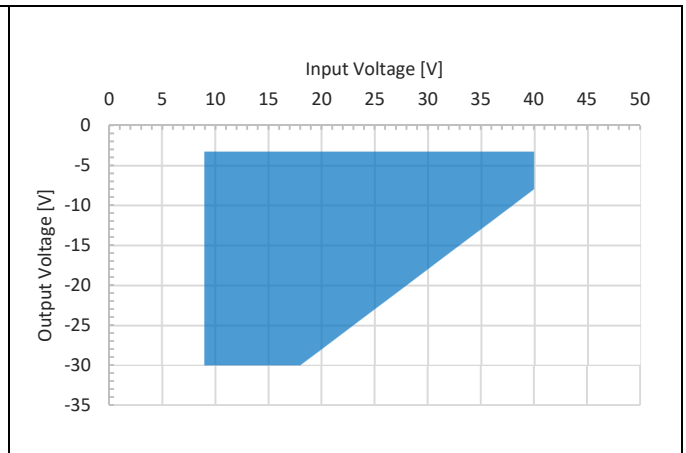

Output Voltage 2 vs. Input Voltage Operating Range.

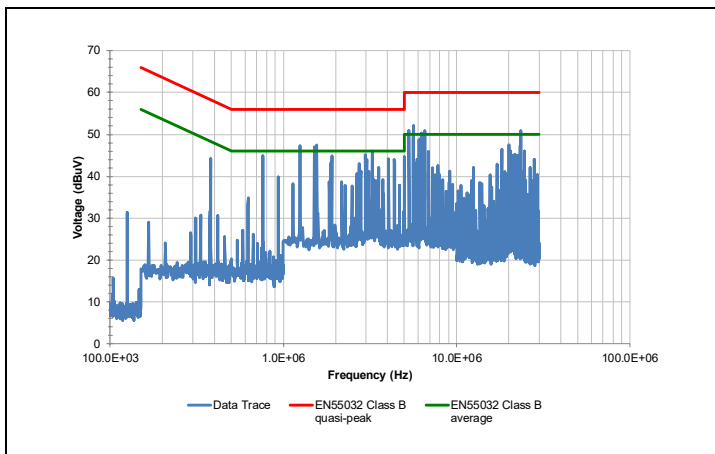

Typical Conducted Emissions Vin = 24V, Vo = 5V, full load.

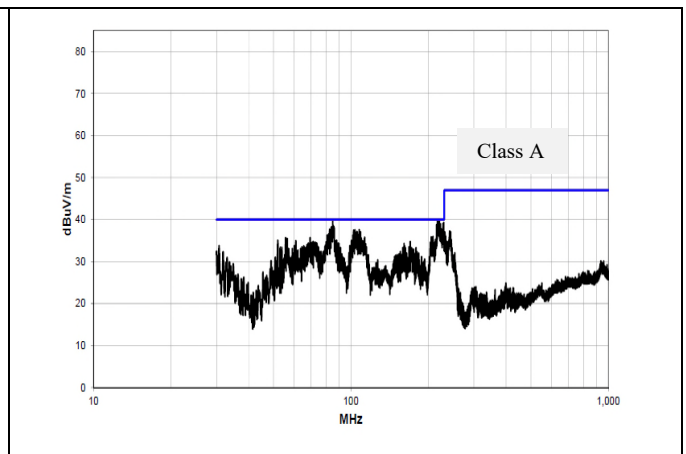

Typical Radiated Emissions Vin = 24V, Vo1 = |Vo2| = 12V, Io1 = Io2 = 70% of Full load.



## Thermal Characteristics: DDA325N-D2PN-1212-001

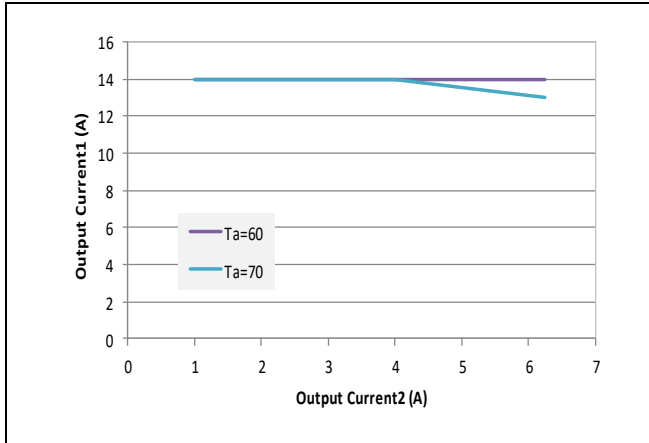

Vo1 = 12,Vo2 = -12V, Vin = 15V Output Current1 vs. Output Current2 at various ambient temperatures with NC (60lfm) airflow.

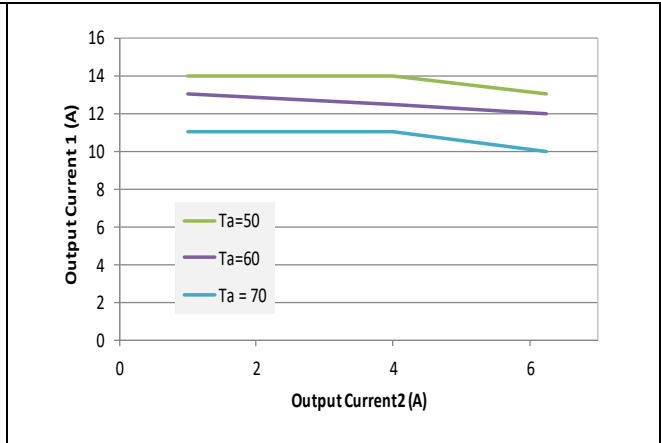

Vo1 = 12,Vo2 = -12V, Vin = 36V Output Current1 vs. Output Current2 at various ambient temperatures with NC (60lfm) airflow.

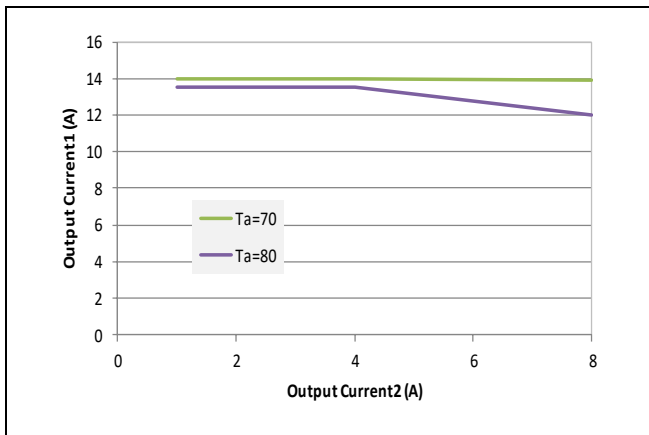

Vo1 = 5,Vo2 = -5V, Vin = 24V Output Current1 vs. Output Current2 at various ambient temperatures with NC (60lfm) airflow.

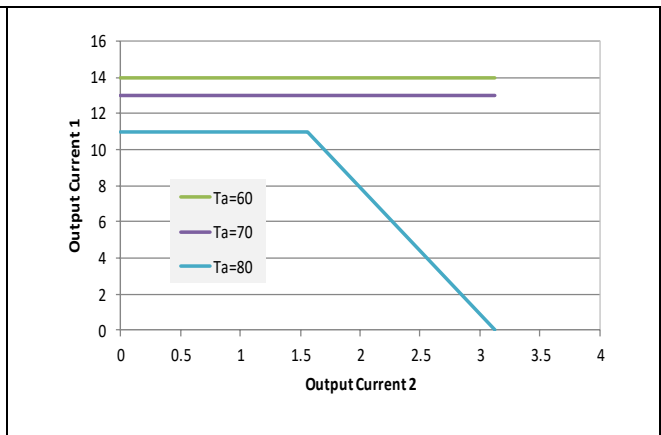

Vo1 = 18,Vo2 = -24V, Vin = 24V Output Current1 vs. Output Current2 at various ambient temperatures with NC (60lfm) airflow.

The two power trains of the DDA325N-D2PN-1212-001 are well coupled thermally. This results in the thermal derating being dependent upon the total power dissipation. The two channels can't be decoupled and treated as independent supplies. If one output is operated at or near full output current, the other output may have very limited output current capacity. To ensure long term reliable operation, care must be taken not to operate at excessive temperatures. The power loss is determined primarily by input voltage and output current values, the output voltage setting is not typically a primary temperature driver.

The thermal curves provided are based upon measurements made in TDK-Lambda's experimental test setup. Due to the large number of variables in system design, TDK-Lambda recommends that the user confirm the temperature in the end application. TDK-Lambda can provide supplies with a thermocouple pre-mounted to the critical component for system verification tests. Contact TDK-Lambda technical support for information on operation with airflows or conditions not shown in the data sheet.

## Electrical Data: DDA500N-D2PP-1205-001

Characteristic	Min	Typ	Max	Unit	Notes & Conditions
Nominal Output Voltage	---	12	---	V	Output 1
Nominal Output Voltage	---	5	---	V	Output 2
Output Voltage Adjustment Range (Out 1)	3.3	---	15	V	Voltage step down only
Output Voltage Adjustment Range (Out 2)	3.3	---	15	V	Voltage step down only
Efficiency Vo1 = Vo2 = 5V	---	92	---	%	Vin=12V; Io=Io,max; Tc = 25 °C
Efficiency Vo1 = Vo2 = 12V	---	95	---	%	Vin=24V; Io=Io,max; Tc = 25 °C
Efficiency Vo1 = Vo2 = 12V	---	93	---	%	Vin=48V; Io=Io,max; Tc = 25 °C
Line Regulation	---	25	---	mV	Vin=Vin,min to Vin,max
Load Regulation	---	150	---	mV	Io=Io,min to Io,max
Maximum Output Current 1	---	---	20	A	Observe maximum power limit and thermal derating
Maximum Output Current 2	---	---	---	---	---
Output Current Limiting Threshold 1	---	28	---	A	Vo = 0.9*Vo1,nom, Tc<Tc,max
Output Current Limiting Threshold 2	---	28	---	A	Vo = 0.9*Vo2,nom, Tc<Tc,max
Short Circuit Current	---	0.5	---	A	Vo = 0.25V, Tc = 25 °C
Output Ripple and Noise Voltage Output 1	---	60	---	mVpp	Measured at output terminal, BW = 20MHz, Vin = 24V, Vo = 12V, Io = Full Load
Output Ripple and Noise Voltage Output 2	---	60	---	mVpp	Measured at output terminal, BW = 20MHz, Vin = 24V, Vo = 12V, Io = Full Load
Output Voltage Sense Range (Out 1 & 2)	---	---	5	%	
Dynamic Response Output 1: Recovery Time	---	70	---	μs	di/dt = 1A/μs, Vin = Vin,nom; Vo1 = 12V, load step from 25% to 75% of Io,max
Transient Voltage	---	600	---	mV	
Dynamic Response Output 2: Recovery Time	---	70	---	μs	di/dt = 1A/μs*, Vin = Vin,nom; Vo2 = 12V, load step from 25% to 75% of Io,max
Transient Voltage	---	600	---	mV	
Switching Frequency	---	400	---	kHz	Fixed
External Load Capacitance Output 1	0	---	1000*	μF	
External Load Capacitance Output 2	0	---	1000*	μF	

\* Please contact TDK-Lambda for technical support for very low esr capacitor banks or if higher capacitance or higher slew rates are required

## Electrical Characteristics: DDA500N-D2PP-1205-001

The DDA500N-D2PP-1205-001 features two power trains which are identical to the DDA250N-S1-PX-12-001. Please refer to the DDA250N-S1-PX-12-001 pages of the data sheet for typical electrical performance information.

## Thermal Characteristics:

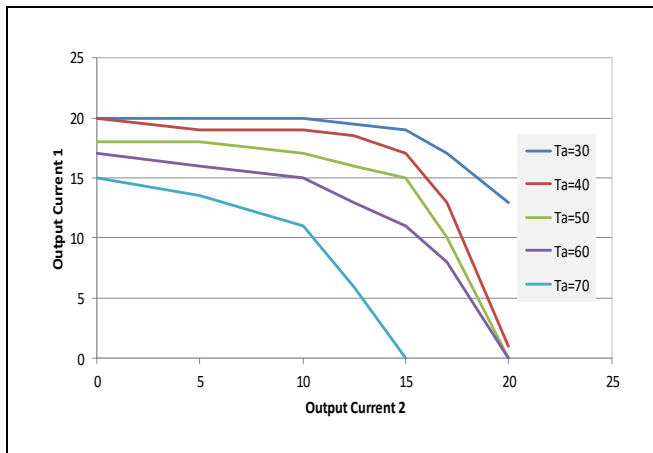

Vo1 = Vo2 = 12V, Vin = 24V Output Current1 vs. Output Current2 at various ambient temperatures with NC (60lfm) airflow.

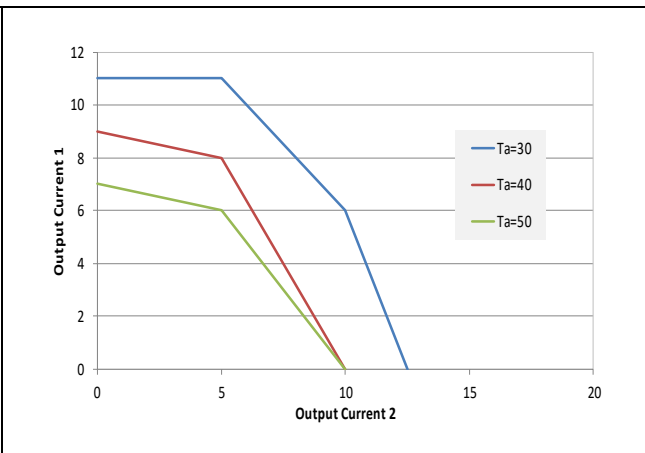

Vo1 = Vo2 = 12V, Vin = 53V output current1 vs. output current 2 at various ambient temperatures with NC (60lfm) airflow.

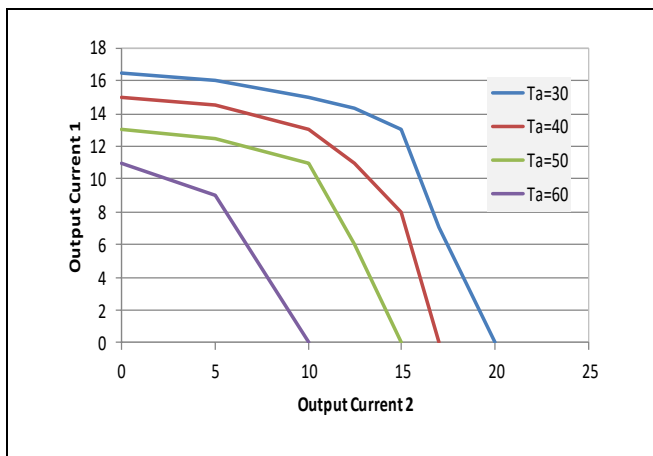

Vo1 = Vo2 = 12V, Vin = 36V Output Current1 vs. Output Current2 at various ambient temperatures with NC (60lfm) airflow.

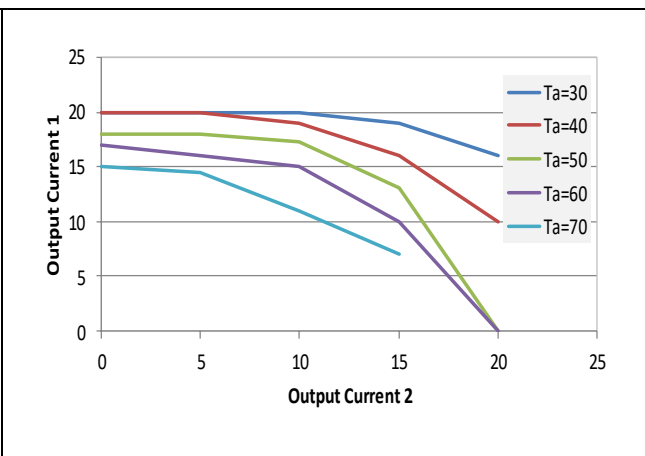

Vo1 = 12V Vo2 = 5V, Vin = 24V Output Current1 vs. Output Current2 at various ambient temperatures with NC (60lfm) airflow.

The two power trains of the DDA500N-D2PP-1205-001 are well coupled thermally. This results in the thermal derating being dependent upon the total power dissipation. The two channels can't be decoupled and treated as independent supplies. If one output is operated at or near full output current, the other output may have very limited output current capacity. To ensure long term reliable operation, care must be taken not to operate at excessive temperatures. The power loss is determined primarily by input voltage and output current values, the output voltage setting is not typically a primary temperature driver.

The thermal curves provided are based upon measurements made in TDK-Lambda's experimental test setup. Due to the large number of variables in system design, TDK-Lambda recommends that the user confirm the temperature in the end application. TDK-Lambda can provide supplies with a thermocouple pre-mounted to the critical component for system verification tests. Contact TDK-Lambda technical support for information on operation with airflows or conditions not shown in the data sheet.

## **Thermal Management:**

An important part of the overall system design process is thermal management; thermal design must be considered at all levels to ensure good reliability and lifetime of the final system. Superior thermal design and the ability to operate in severe application environments are key elements of a robust, reliable power supply.

For proper application of the power supply in a given thermal environment, output current derating curves are provided as a design guideline.

The module temperature should be measured in the final system configuration to ensure proper thermal management. In all conditions, the power module should be operated below the maximum operating temperature shown on the derating curve.

For improved design margins and enhanced system reliability, the power module may be operated at temperatures below the maximum rated operating temperature.

The heat dissipating components of the DDA power train are well coupled to the metal case. During operation care should be taken as the metal may become hot to the touch. Heat transfer by convection can be enhanced by increasing the airflow rate that the power supply experiences. When using convection to cool the DDA, care should be taken to avoid blocking the vent holes in the metal case.

## **Operating Information:**

### **Output Voltage Adjustment:**

The output voltage is preset to the nominal value shown in the electrical characteristic page of the data sheet. The output of the power module can be fine-tuned or changed to a different value by adjusting the trim potentiometers on the front face of the DDA supply. Turning the potentiometer clockwise, lowers the resistance and causes the output voltage to increase. Due to the wide output adjustment range, care should be taken to avoid setting the output to a high value that could damage the load.

The maximum power available from the power module is fixed. As the output voltage is trimmed up, the maximum output current must be decreased to operate within the maximum rating of the module.

### **Over-Current Protection:**

The power supplies have short circuit protection to protect the module during severe overload conditions. During overload conditions, the power supplies may protect themselves by entering a hiccup current limit mode. The supplies will operate normally once the output current returns to the specified operating range.

Long term operation outside the rated conditions and prior to the hiccup protection engaging is not recommended.

The over-current protection circuit uses input voltage information to detect short circuit conditions at the output. Severe load transients, e.g. – no load to full load changes with high rates of change can create temporary surges that would cause the protection circuit to engage. Contact TDK-Lambda technical support for support in applications where this may be a concern.

### **Remote On/Off:**

Many of the DDA supplies feature step down converters that can't regulate the output voltage until the input voltage exceeds the desired output voltage setpoint. As noted in the electrical characteristics page, the output voltage will not be in regulation at low input voltages and the input current can be high. Care should be taken to make sure the source providing power to the DDA is capable of providing sufficient current during startup.

To help achieve predictable startup sequencing and avoid operating in unspecified operating ranges, the DDA power supplies offer a negative logic remote on/off feature located on terminals 5 and 6 of the front connector. The user must supply a connection between GND and the on/off terminals to enable the power supply.

The maximum voltage generated by the power module at the On/Off terminal is  $V_{in,max}$ . The maximum allowable leakage current is 10  $\mu$ A. To process power, the On/Off terminals must be held in a low state,  $V_{on/off} < 0.25V$ , while sinking up to 1mA.

When using the On/Off feature on the dual polarity, inverting and non-inverting model such as DDA325N-D2PN-1212-001, the On/Off terminals should not be connected directly together or the positive output will remain in an always on condition. Either independent switches should be provided or a low Vf diode can be installed as shown in the figure.

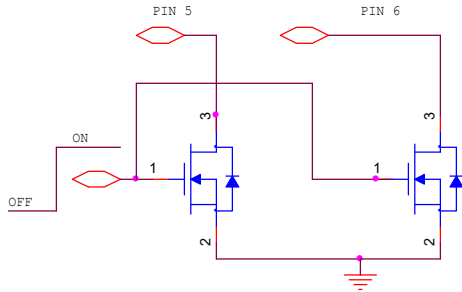
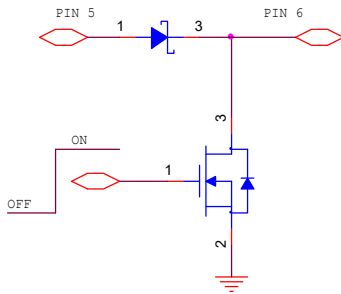

A voltage source should not be applied to the on/off terminals. If the negative logic feature is not being used, terminal 5 and 6 should be connected to ground to enable the power supply.

### Remote Sense:

The power supplies feature remote sense to help compensate for the effect of output distribution drops. The output voltage sense range defines the maximum voltage allowed between the output power and sense terminals, and it is found on the electrical data page for the power module of interest. If the remote sense feature is not being used, the Sense terminal should be connected to the Vo terminal to avoid additional voltage droop.

The output voltage at the Vo terminal can be increased by both the remote sense and the output voltage adjustment feature. The maximum voltage allowed is the larger of the remote sense range or the output voltage adjustment range; it is not the sum of both. As the output voltage increases due to the use of the remote sense, the maximum output current may need to be decreased for the power module to remain below its maximum power rating.

### Power Good:

The power supplies feature power good signals on signal terminals 5 and 6. When the output voltage is being regulated, the power good pins are pulled up internally to a 5.0V source by a 10Kohm resistor. When power is applied to the module, but the output voltage is typically more than +/- 12% from the nominal voltage set point due to input under voltage, over temperature, over load, or loss of control the power good signals will be pulled to ground through a 75 ohm maximum impedance.

If the power good feature is not used, the pin should be left open. A voltage source should not be applied to the power good pins.

LEDs on the power supply's front face plate provide a visual status indicator of the power good signal status.

### EMC:

TDK-Lambda power supplies are designed for use in a wide variety of systems and applications. The DDA power supplies meet CISPR-32 Class A radiated requirements and Class B conducted requirements in most applications and configurations. For assistance with designing for EMC compliance, please contact TDK-Lambda technical support.

### Input Impedance:

The DDA features sufficient input capacitance for most applications.

## **Reliability and E-Cap Life:**

The power supplies are designed using TDK-Lambda's stringent design guidelines for component derating, product qualification, and design review process. The MTBF is calculated to be greater than 5 million hours at full output power at Ta = 40 °C using the Telcordia SR-332 calculation method.

This product uses one or more high reliability, long life aluminum electrolytic capacitors. Device derating and careful thermal management techniques have been applied to maximize the useable life of the product. Electrolytic capacitor wear out time varies depending upon the end application's ambient temperature and operating condition.

Ambient Temperature (Ta)	Output Load	E-Cap Life *
40 °C	50%	10 Yrs

\* Based on continuous operation - contact Technical Support for other ambient and load conditions.

## **Quality:**

TDK-Lambda's product development process incorporates advanced quality planning tools such as FMEA and Cpk analysis to ensure designs are robust and reliable. All products are assembled at ISO certified assembly plant.

## **Safety Considerations:**

As of the publishing date, certain safety agency approvals may have been received on the DDA series and others may still be pending. Check with TDK-Lambda for the latest status of safety approvals on the DDA product line.

For safety agency approval of the system in which the DC-DC power module is installed, the power module must be installed in compliance with the creepage and clearance requirements of the safety agency. The power supplies are internally fused in accordance with UL requirements. The fuses are not serviceable.

## **Warranty:**

TDK-Lambda's comprehensive line of power solutions includes efficient, high-density DC-DC converters. TDK-Lambda offers a (3) three-year limited warranty. Complete warranty information is listed on our web site or is available upon request from TDK-Lambda.

Information furnished by TDK-Lambda is believed to be accurate and reliable. However, TDK-Lambda assumes no responsibility for its use, nor for any infringement of patents or other rights of third parties, which may result from its use. No license is granted by implication or otherwise under any patent or patent rights of TDK-Lambda. TDK-Lambda components are not designed to be used in critical applications, such as nuclear control systems or life support systems, wherein failure or malfunction could result in injury or death. All sales are subject to TDK-Lambda's Terms and Conditions of Sale, which are available upon request. Specifications are subject to change without notice.



## TDK-Lambda France SAS

Tel: +33 1 60 12 71 65  
france@fr.tdk-lambda.com  
www.emea.lambda.tdk.com/fr



## Italy Sales Office

Tel: +39 02 61 29 38 63  
info.italia@it.tdk-lambda.com  
www.emea.lambda.tdk.com/it



## Netherlands

info@nl.tdk-lambda.com  
www.emea.lambda.tdk.com/nl



## TDK-Lambda Germany GmbH

Tel: +49 7841 666 0  
info.germany@de.tdk-lambda.com  
www.emea.lambda.tdk.com/de



## Austria Sales Office

Tel: +43 2256 655 84  
info@at.tdk-lambda.com  
www.emea.lambda.tdk.com/at



## Switzerland Sales Office

Tel: +41 44 850 53 53  
info@ch.tdk-lambda.com  
www.emea.lambda.tdk.com/ch



## Nordic Sales Office

Tel: +45 8853 8086  
info@dk.tdk-lambda.com  
www.emea.lambda.tdk.com/dk



## TDK-Lambda UK Ltd.

Tel: +44 (0) 12 71 85 66 66  
powersolutions@uk.tdk-lambda.com  
www.emea.lambda.tdk.com/uk



## TDK-Lambda Ltd.

Tel: +9 723 902 4333  
info@tdk-lambda.co.il  
www.emea.lambda.tdk.com/il



## C.I.S.

### Commercial Support:

Tel: +7 (495) 665 2627

### Technical Support:

Tel: +7 (812) 658 0463  
info@tdk-lambda.ru  
www.emea.lambda.tdk.com/ru



## TDK-Lambda Americas

Tel: +1 800-LAMBDA-4 or 1-800-526-2324  
powersolutions@us.tdk-lambda.com  
www.us.lambda.tdk.com



## TDK Electronics do Brasil Ltda

Tel: +55 11 3289-9599  
sales.br@tdk-electronics.tdk.com  
www.tdk-electronics.tdk.com/en



## TDK-Lambda Corporation

Tel: +81-3-6778-1113  
www.jp.lambda.tdk.com



## TDK-Lambda (China) Electronics Co. Ltd.

Tel: +86 21 6485-0777  
powersolutions@cn.tdk-lambda.com  
www.lambda.tdk.com.cn



## TDK-Lambda Singapore Pte Ltd.

Tel: +65 6251 7211  
tts.mkt@sg.tdk-lambda.com  
www.sg.lambda.tdk.com



## TDK India Private Limited, Power Supply Division

Tel: +91 80 4039-0660  
mathew.philip@in.tdk-lambda.com  
www.sg.lambda.tdk.com

