

DPX40-xxSxx Single Output: DC-DC Converter Module

9.5 ~ 18 VDC, 18 ~ 36 VDC and 36 ~ 75 VDC input; 3.3 to 28 VDC Single Output;
40 Watts Output Power



FEATURES

- 1600VDC INPUT TO OUTPUT ISOLATION
- SCREW TERMINALS FOR INPUT AND OUTPUT CONNECTIONS
- RELIABLE SNAP-ON FOR DIN RAIL TS-35/7.5 OR TS-35/15
- CASE PROTECTION MEETS IP20(IEC60529)
- INPUT FUSE PROTECTION
- INPUT REVERSE POLARITY PROTECTION
- INPUT IN-RUSH CURRENT LIMIT CIRCUIT
- OUTPUT DC-OK INDICATOR
- 2:1 WIDE INPUT VOLTAGE RANGE
- FIXED SWITCHING FREQUENCY
- INPUT UNDER-VOLTAGE PROTECTION
- OUTPUT OVER-VOLTAGE PROTECTION
- OVER-CURRENT PROTECTION
- OUTPUT SHORT CIRCUIT PROTECTION
- MEETS EN55022 CLASS B
- COMPLIANT TO RoHS II & REACH



CE MARKED

SAFETY MEETS: UL60950-1
EN60950-1
IEC60950-1

APPLICATIONS

- COMMUNICATION SYSTEMS
- INDUSTRY CONTROL SYSTEMS
- FACTORY AUTOMATION EQUIPMENT
- SEMICONDUCTOR EQUIPMENT

OPTIONS

- REMOTE ON/OFF

GENERAL DESCRIPTION

The DPX40-xxSxx series was designed for applications requiring din rail mountable DC-DC converters. Easy installation is provided with snap-on mounting to the DIN-rail. Internal circuits provide protection against reverse input voltage, input in-rush current, output short-circuit, output over-current, and output over-voltage conditions. A green LED at the front panel indicates the status of the output voltage.

Contents

Output Specifications	3
Input Specifications	4
General Specifications	5
Environmental Specifications	5
EMC Characteristics	5
Characteristic Curves	
DPX40-12S3P3	6
DPX40-12S05	8
DPX40-12S12	10
DPX40-12S15	12
DPX40-12S24	14
DPX40-12S28	16
DPX40-24S3P3	18
DPX40-24S05	20
DPX40-24S12	22
DPX40-24S15	24
DPX40-24S24	26
DPX40-24S28	28
DPX40-48S3P3	30
DPX40-48S05	32
DPX40-48S12	34
DPX40-48S15	36
DPX40-48S24	38
DPX40-48S28	40
Input Source Impedance	42
Output Over Current Protection	42
Output Short Circuit Protection	42
Output Over Voltage Protection	42
Remote On/off Control	43
EMS Considerations	43
Mechanical Data	44
Packaging Information	44
Part Number Structure	45
MTBF and Reliability	45

Output Specifications

Parameter	Model	Min	Typ	Max	Unit
Output Voltage (Vin(nom); Full Load; Ta=25°C)	xxS3P3	3.234	3.3	3.366	VDC
	xxS05	4.925	5	5.075	
	xxS12	11.82	12	12.18	
	xxS15	14.775	15	15.225	
	xxS24	23.64	24	24.36	
	xxS28	27.58	28	28.42	
Output Regulation Line (Vin(min) to Vin(max); Full Load) Load (Min. Load to 100% of Full Load)	All	-0.5		+0.5	%
	xxS3P3	-2.0		+2.0	
	Others	-1.5		+1.5	
Output Ripple and Noise Peak to Peak (20MHz Bandwidth)	xxS3P3		50	75	mVp-p
	xxS05		50	75	
	xxS12		75	100	
	xxS15		75	100	
	xxS24		350	400	
	xxS28		350	400	
Voltage Adjustability	xxS28	-3		+17	% of Vout
	Others	-10		+10	
Temperature Coefficient	All	-0.02		+0.02	%/°C
Output Voltage Overshoot (Vin(min) to Vin(max) Full Load; Ta=25°C)	All		0	5	% of Vout
Dynamic Load Response (Vin(nom); Ta=25°C) Load step change from 75% to 100% or 100 to 75% of Full Load Peak Deviation Settling Time (Vo < 10% peak deviation)	All		300		mV
	All		250		µs
Output Current	xxS3P3	0		8000	mA
	xxS05	0		8000	
	xxS12	0		3333	
	xxS15	0		2666	
	xxS24	144		1800	
	xxS28	112		1400	
Output Capacitance Load	xxS3P3			21000	µF
	xxS05			13600	
	xxS12			2360	
	xxS15			1510	
	xxS24			600	
	xxS28			375	
Output Over Voltage Protection (see page 42) (Zener diode clamp)	xxS3P3		3.9		VDC
	xxS05		6.2		
	xxS12		15		
	xxS15		18		
	xxS24		30		
	xxS28		36		
Output Indicator	All	Green LED			
Output Over Current Protection (see page 42) (% of Iout rated; Hiccup mode)	All			150	% of FL
Output Short Circuit Protection (see page 42)	All	Continuous, automatic recovery			

Input Specifications

Parameter	Model	Min	Typ	Max	Unit	
Operating Input Voltage Continuous	12Sxx	9.5	12	18	VDC	
	24Sxx	18	24	36		
	48Sxx	36	48	75		
	Transient (100ms,max)	12Sxx				36
		24Sxx				50
		48Sxx				100
Input Standby Current (Vin(nom); No Load)	12S3P3		179		mA	
	12S05		232			
	12S12		262			
	12S15		320			
	12S24		42			
	12S28		50			
	24S3P3		67			
	24S05		82			
	24S12		87			
	24S15		92			
	24S24		32			
	24S28		32			
	48S3P3		42			
	48S05		44			
	48S12		54			
	48S15		57			
48S24		23				
48S28		23				
Under Voltage Lockout Turn-on Threshold	12Sxx			9.5	VDC	
	24Sxx			18		
	48Sxx			36		
Under Voltage Lockout Turn-off Threshold	12Sxx		8		VDC	
	24Sxx		16			
	48Sxx		33			
Input Reflected Ripple Current (see page 42) (Vin(nom); Full Load)	All		15		mAp-p	
Start Up Time (Vin(nom) and constant resistive load) Power up Remote ON/OFF	All		100		ms	
			25			
Remote ON/OFF Control (see page 43) (The Ctrl pin voltage is referenced to negative input) Positive Logic (Optional) On/Off pin High Voltage (Remote ON) On/Off pin Low Voltage (Remote OFF)	xxSxx-P		Open or 3.5 ~ 12VDC Short or 0 ~ 1.2VDC			
Negative Logic (Optional) On/Off pin Low Voltage (Remote ON) On/Off pin High Voltage (Remote OFF)	xxSxx-N		Short or 0 ~ 1.2VDC Open or 3.5 ~ 12VDC			
Input Current of Remote Control Pin		-0.5		0.5	mA	
Remote Off State Input Current			2.5		mA	
Input Fuse (Slow Blow)	12Sxx		8		A	
	24Sxx		8			
	48Sxx		4			
In-rush Current	All		15		A	

General Specifications

Parameter	Model	Min	Typ	Max	Unit
Efficiency (Vin(nom); Full Load; Ta=25°C)	12S3P3		84		%
	12S05		84		
	12S12		84		
	12S15		85		
	12S24		83		
	12S28		83		
	24S3P3		85		
	24S05		87		
	24S12		86		
	24S15		87		
	24S24		86		
	24S28		86		
	48S3P3		86		
	48S05		88		
	48S12		87		
	48S15		87		
48S24		86			
48S28		86			
Isolation Voltage (1 minute) Input to Output Input to Chassis, Output to Chassis	All	1600 1600			VDC
Isolation Resistance (500VDC)	All	1			GΩ
Isolation Capacitance	All			4000	pF
Switching Frequency	All	270	300	330	kHz
Safety Meets	All	IEC60950-1, UL60950-1, EN60950-1			
Weight	All	182			g
MTBF (see page 45) MIL-HDBK-217F Ta=25°C, Full load	All	8.080 x 10 ⁵			hours
Chassis Material	All	Aluminum			

Environmental Specifications

Parameter	Model	Min	Typ	Max	Unit
Operating Ambient Temperature	Without derating	-40		+58	°C
	With derating	+58		+97	
Storage Temperature	All	-40		105	°C
Relative Humidity	All	5		95	% RH
Thermal Shock	All	MIL-STD-810F			
Vibration	All	IEC60068-2-6			

EMC Characteristics

Characteristic	Standard	Condition	Level
EMI	EN55022	Module stand-alone	Class B
ESD	EN61000-4-2	Air	±8kV
		Contact	±6kV
Radiated Immunity	EN61000-4-3	10V/m	Perf. Criteria A
Fast Transient (see page 44)	EN61000-4-4	±2kV	Perf. Criteria A
Surge (see page 44)	EN61000-4-5	±1kV	Perf. Criteria A
Conducted Immunity	EN61000-4-6	10V r.m.s	Perf. Criteria A
Power Frequency Magnetic Field	EN61000-4-8	100A/m continuous; 1000A/m 1 second	Perf. Criteria A

Characteristic Curves

All test conditions are at 25°C. The figures are for DPX40-12S3P3

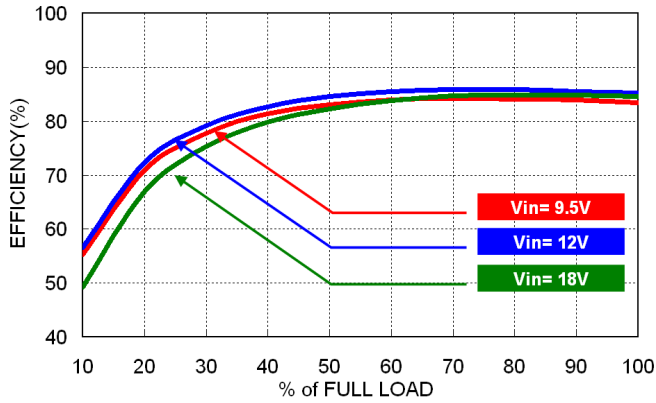

Efficiency versus Output Load

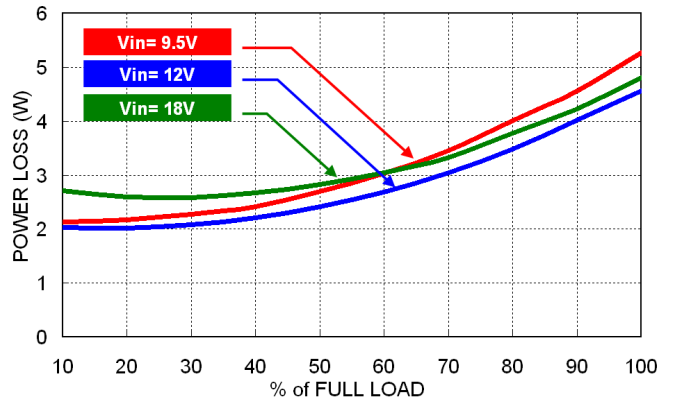

Power Dissipation versus Output Load

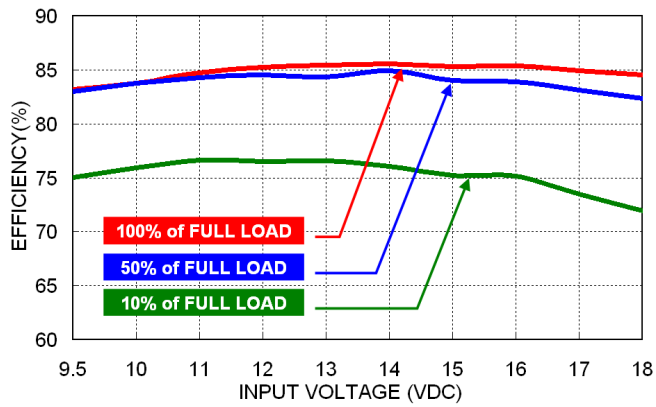

Efficiency versus Input Voltage

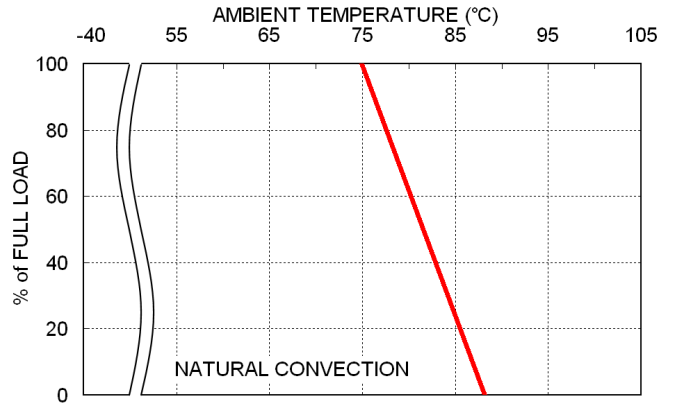

Derating Output Current versus Ambient Temperature and Airflow Vin(nom)

Characteristic Curves (Continued)

All test conditions are at 25°C. The figures are for DPX40-12S3P3

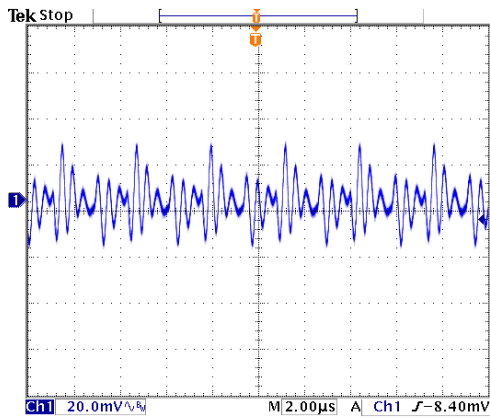

Typical Output Ripple and Noise.
Vin(nom); Full Load

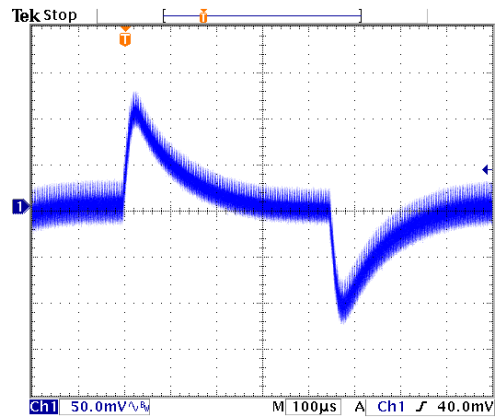

Transient Response to Dynamic Load Change from
100% to 75% to 100% of Full Load; Vin(nom)

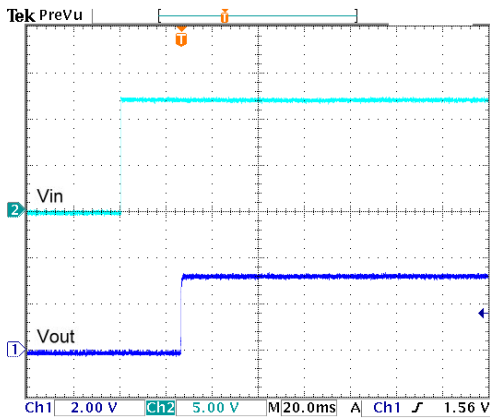

Typical Input Start-Up and Output Rise Characteristic
Vin(nom); Full Load

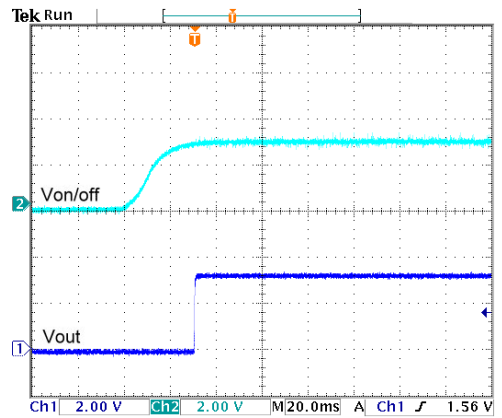

Using ON/OFF Voltage Start-Up and Output Rise Characteristic
Vin(nom); Full Load

Characteristic Curves (Continued)

All test conditions are at 25°C. The figures are for DPX40-12S05

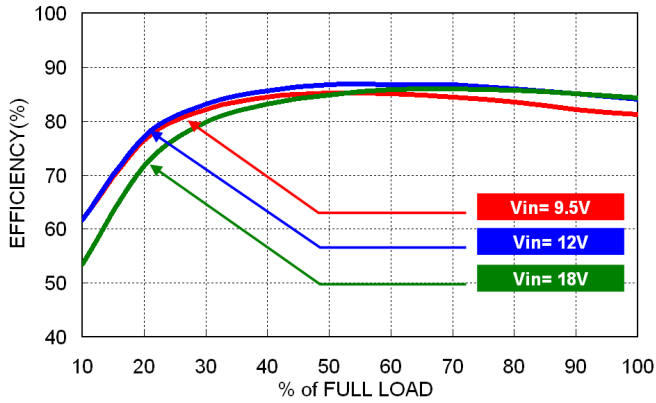

Efficiency versus Output Load

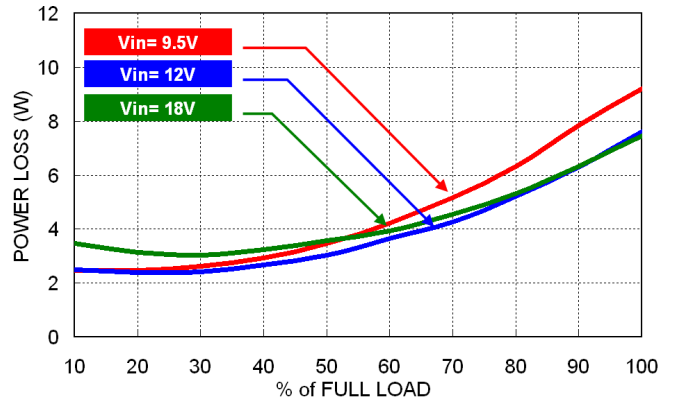

Power Dissipation versus Output Load

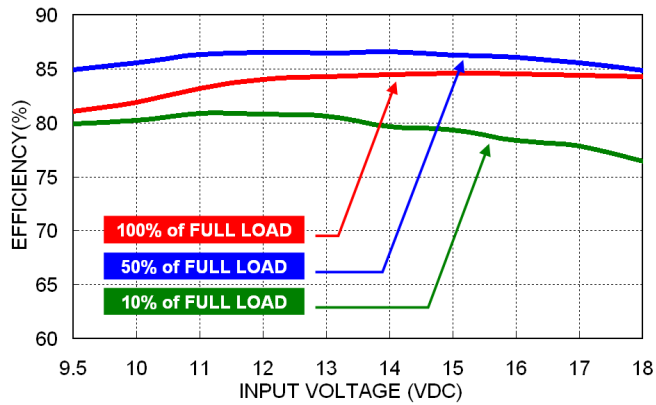

Efficiency versus Input Voltage

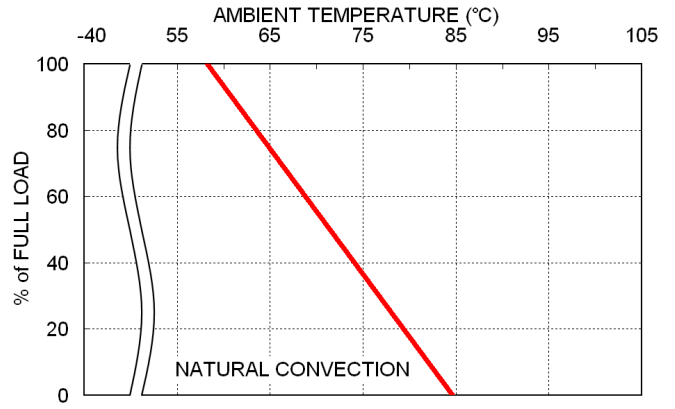

Derating Output Current versus Ambient Temperature and Airflow Vin(nom)

Characteristic Curves (Continued)

All test conditions are at 25°C. The figures are for DPX40-12S05

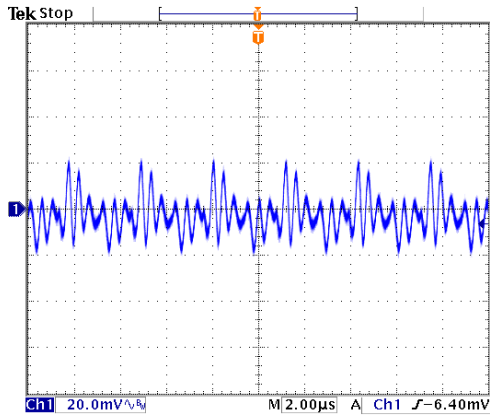

Typical Output Ripple and Noise.
Vin(nom); Full Load

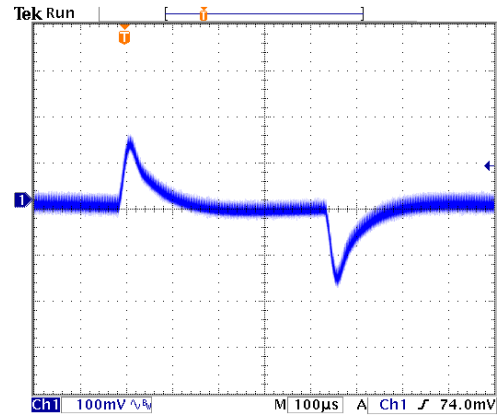

Transient Response to Dynamic Load Change from
100% to 75% to 100% of Full Load; Vin(nom)

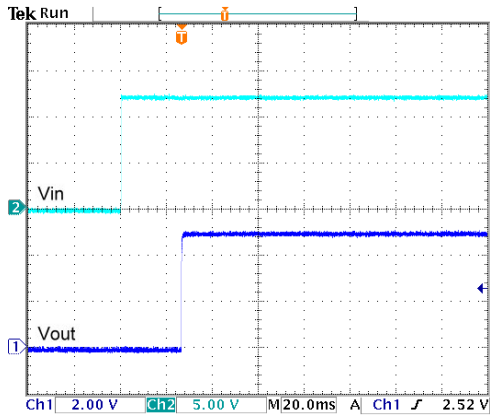

Typical Input Start-Up and Output Rise Characteristic
Vin(nom); Full Load

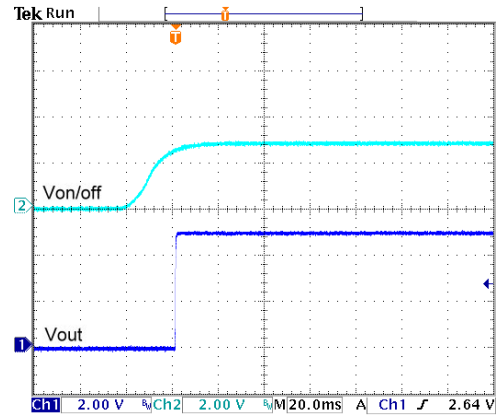

Using ON/OFF Voltage Start-Up and Output Rise Characteristic
Vin(nom); Full Load

Characteristic Curves (Continued)

All test conditions are at 25°C. The figures are for DPX40-12S12

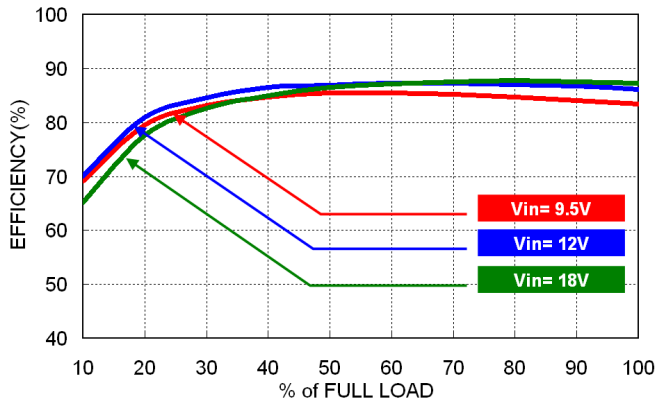

Efficiency versus Output Load

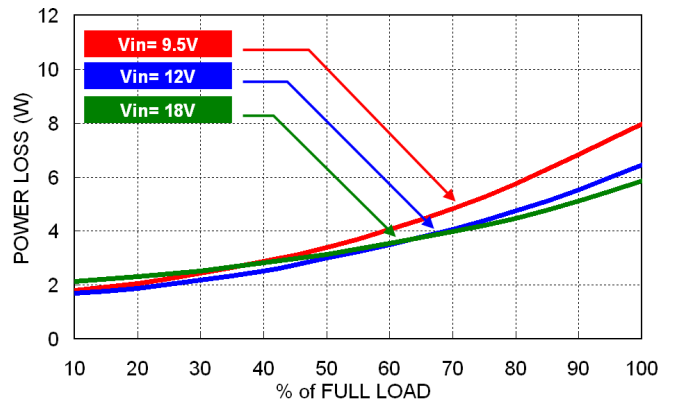

Power Dissipation versus Output Load

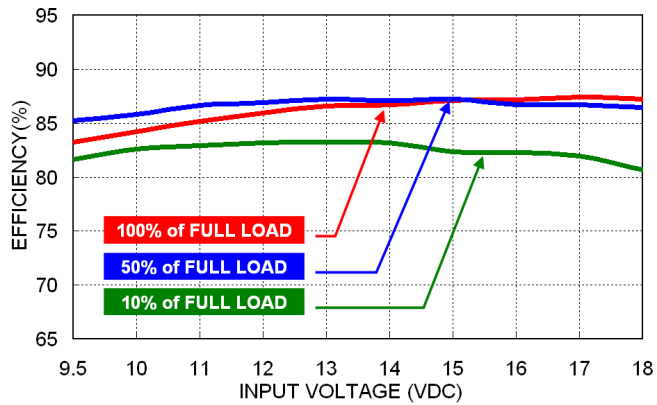

Efficiency versus Input Voltage

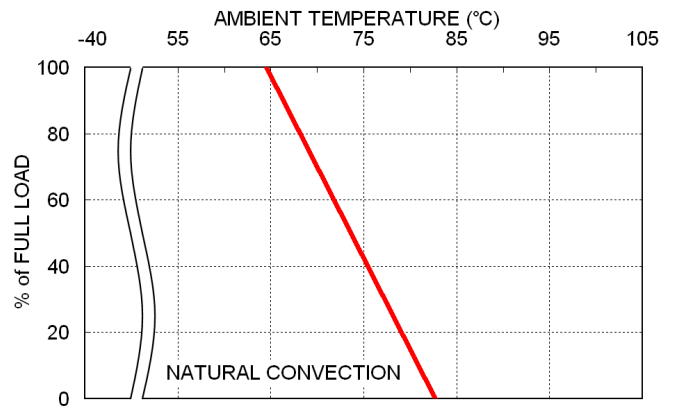

Derating Output Current versus Ambient Temperature and Airflow Vin(nom)

Characteristic Curves (Continued)

All test conditions are at 25°C. The figures are for DPX40-12S12

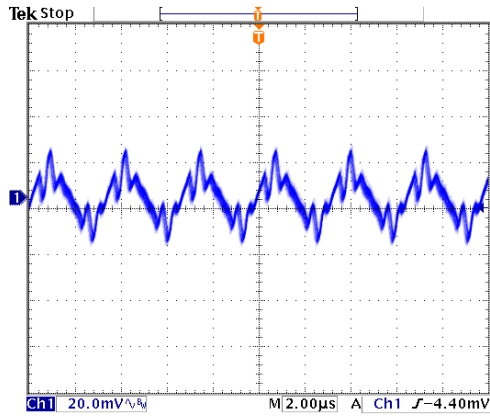

Typical Output Ripple and Noise.
Vin(nom); Full Load

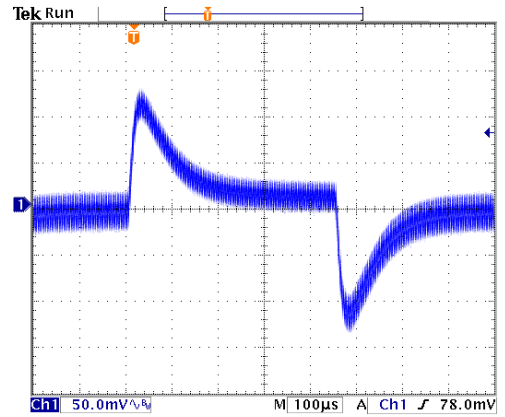

Transient Response to Dynamic Load Change from
100% to 75% to 100% of Full Load; Vin(nom)

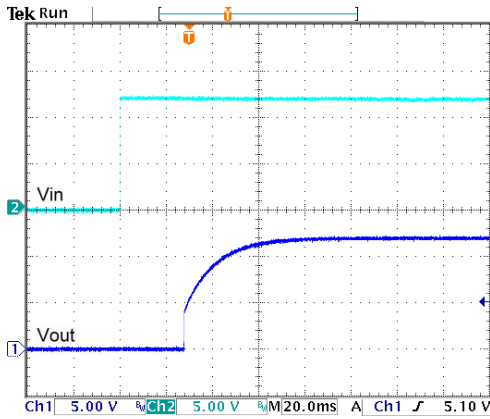

Typical Input Start-Up and Output Rise Characteristic
Vin(nom); Full Load

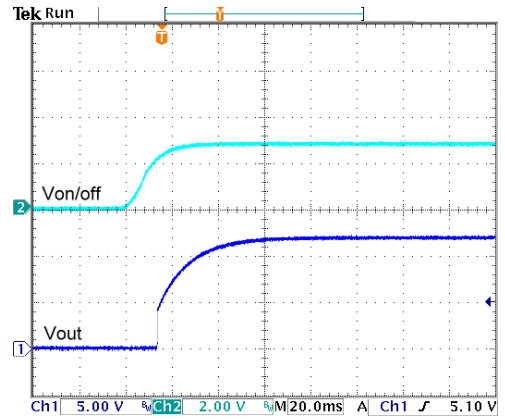

Using ON/OFF Voltage Start-Up and Output Rise Characteristic
Vin(nom); Full Load

Characteristic Curves (Continued)

All test conditions are at 25°C. The figures are for DPX40-12S15

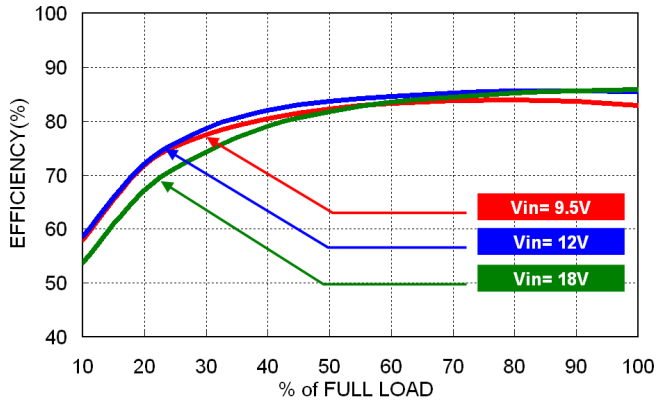

Efficiency versus Output Load

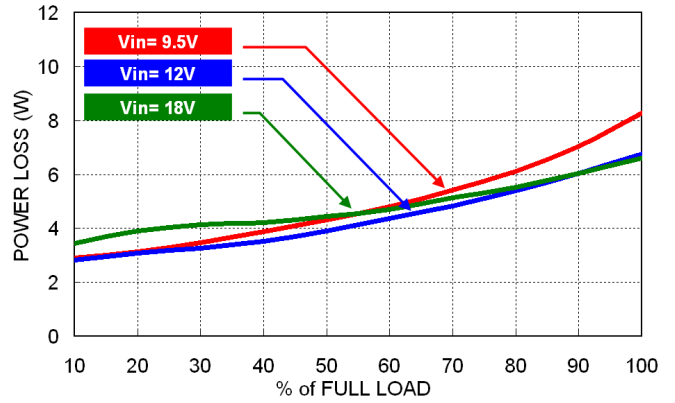

Power Dissipation versus Output Load

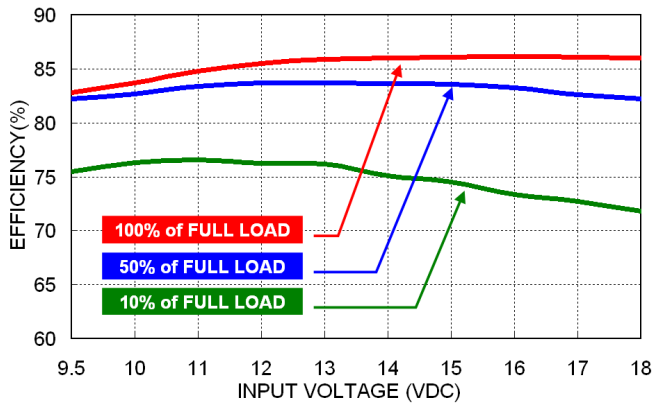

Efficiency versus Input Voltage

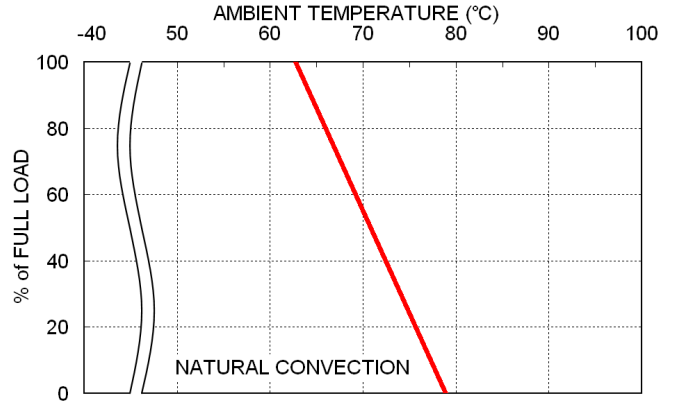

Derating Output Current versus Ambient Temperature and Airflow Vin(nom)

Characteristic Curves (Continued)

All test conditions are at 25°C. The figures are for DPX40-12S15

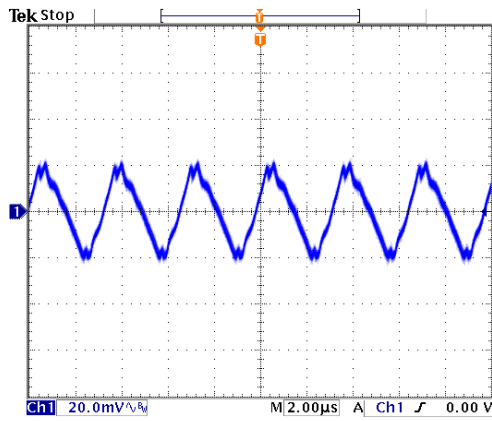

Typical Output Ripple and Noise.
Vin(nom); Full Load

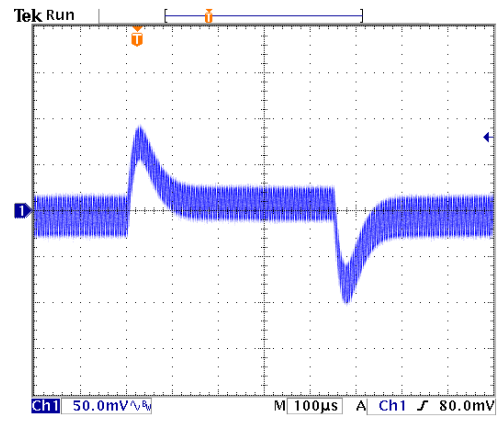

Transient Response to Dynamic Load Change from
100% to 75% to 100% of Full Load; Vin(nom)

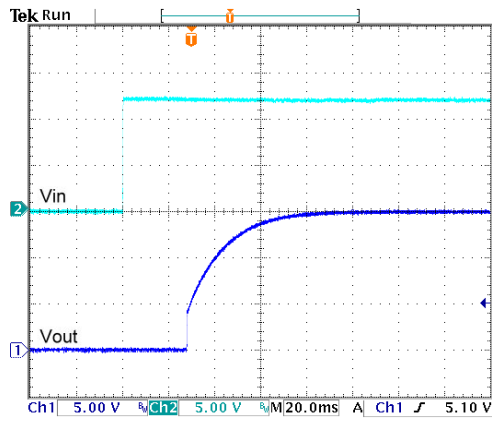

Typical Input Start-Up and Output Rise Characteristic
Vin(nom); Full Load

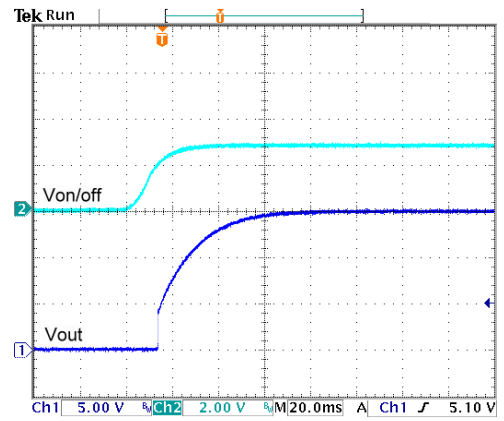

Using ON/OFF Voltage Start-Up and Output Rise Characteristic
Vin(nom); Full Load

Characteristic Curves (Continued)

All test conditions are at 25°C. The figures are for DPX40-12S24

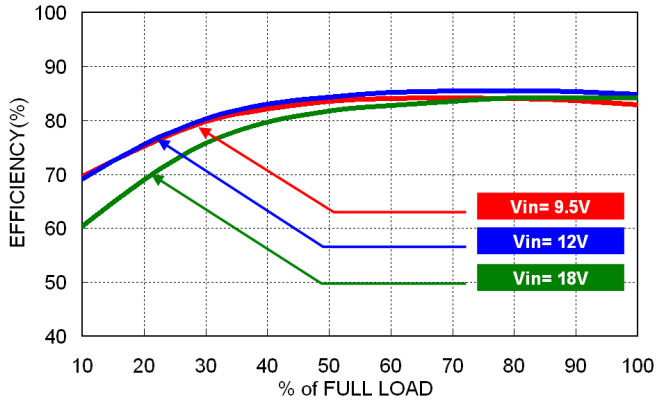

Efficiency versus Output Load

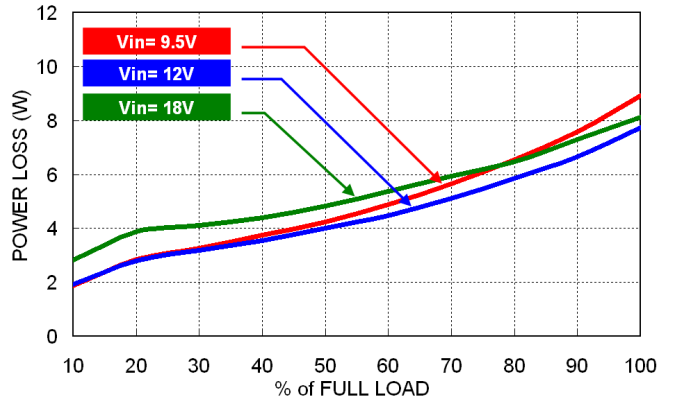

Power Dissipation versus Output Load

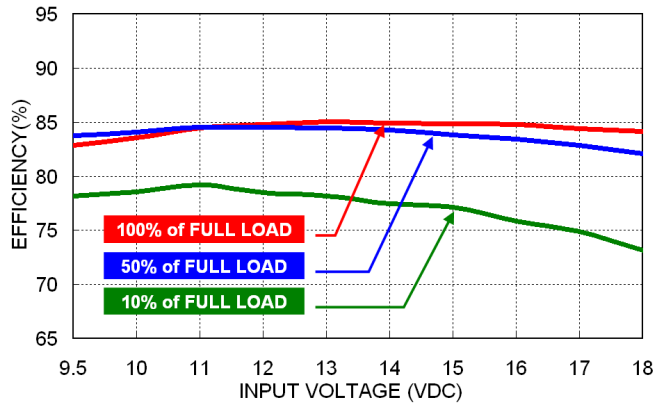

Efficiency versus Input Voltage

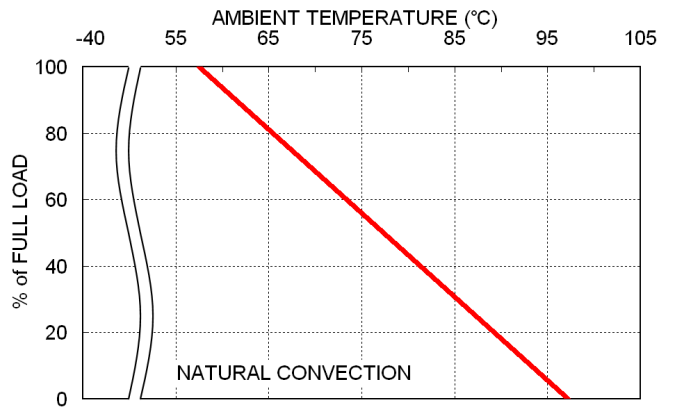

Derating Output Current versus Ambient Temperature and Airflow Vin(nom)

Characteristic Curves (Continued)

All test conditions are at 25°C. The figures are for DPX40-12S24

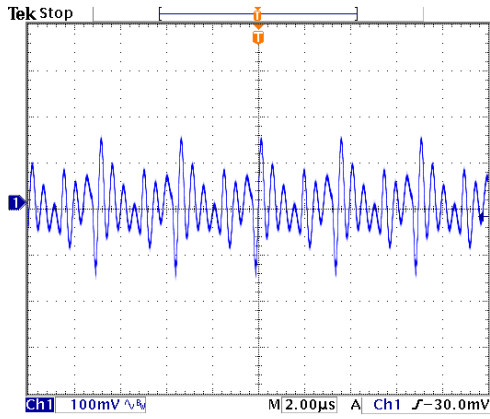

Typical Output Ripple and Noise.
Vin(nom); Full Load

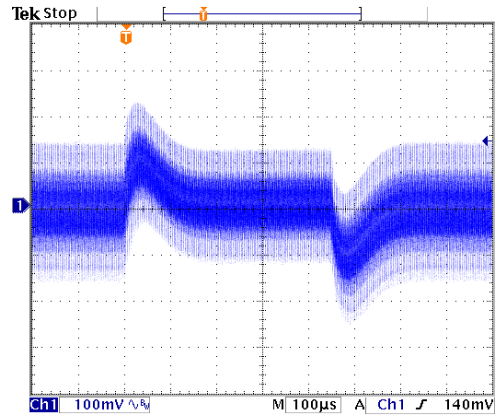

Transient Response to Dynamic Load Change from
100% to 75% to 100% of Full Load; Vin(nom)

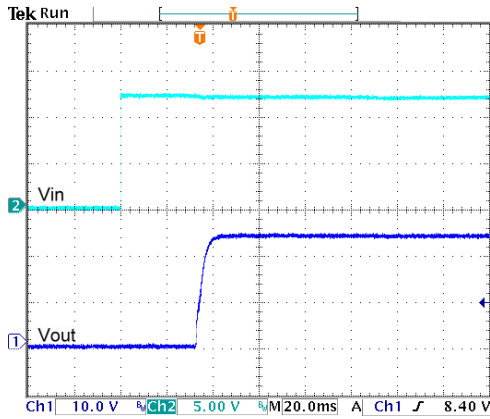

Typical Input Start-Up and Output Rise Characteristic
Vin(nom); Full Load

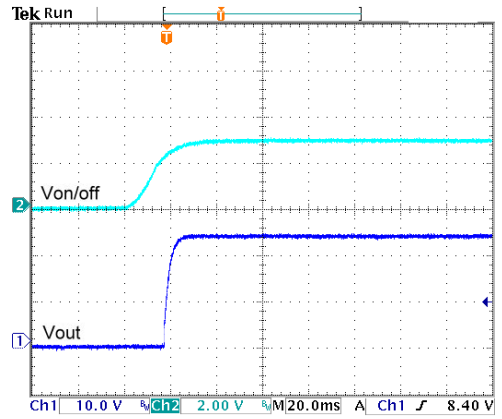

Using ON/OFF Voltage Start-Up and Output Rise Characteristic
Vin(nom); Full Load

Characteristic Curves (Continued)

All test conditions are at 25°C. The figures are for DPX40-12S28

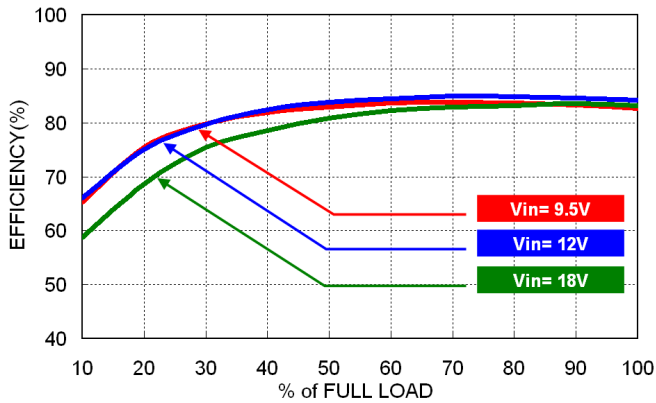

Efficiency versus Output Load

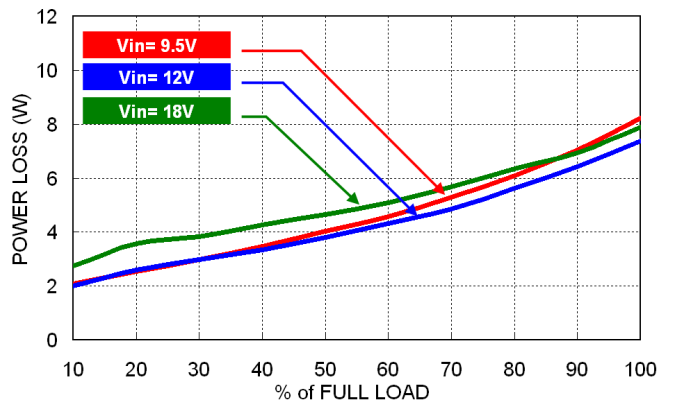

Power Dissipation versus Output Load

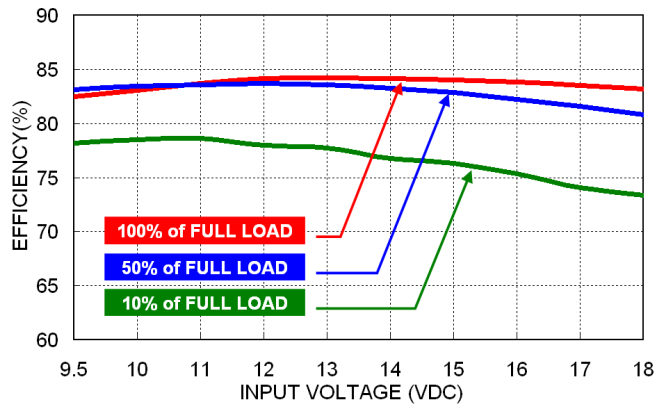

Efficiency versus Input Voltage

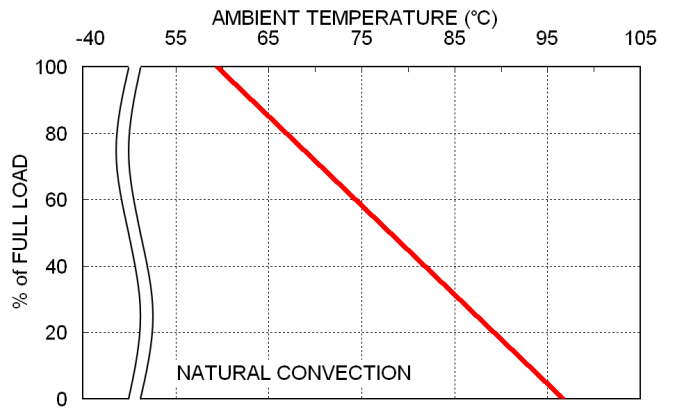

Derating Output Current versus Ambient Temperature and Airflow Vin(nom)

Characteristic Curves (Continued)

All test conditions are at 25°C. The figures are for DPX40-12S28

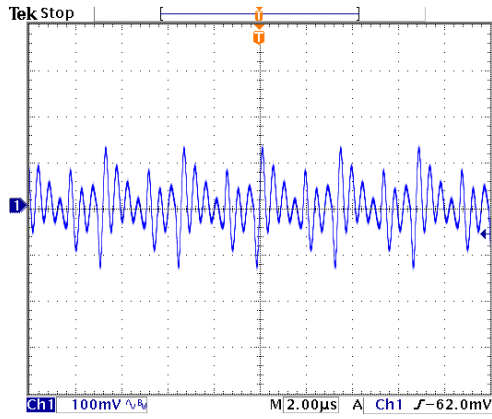

Typical Output Ripple and Noise.
Vin(nom); Full Load

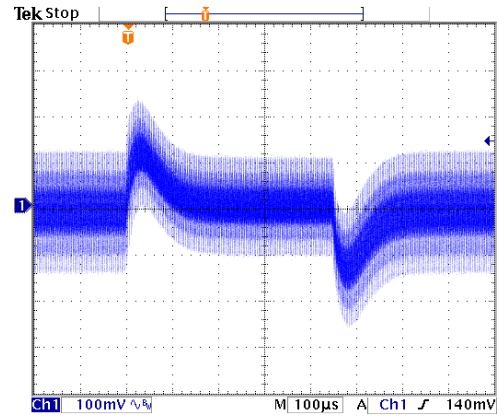

Transient Response to Dynamic Load Change from
100% to 75% to 100% of Full Load; Vin(nom)

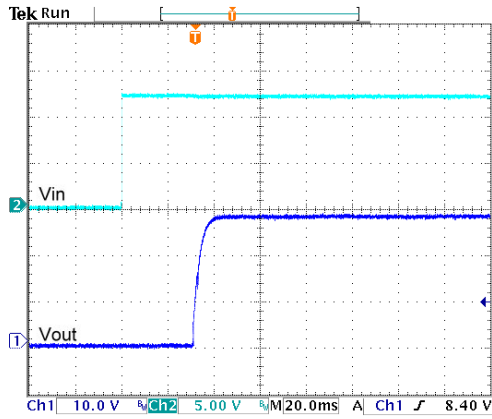

Typical Input Start-Up and Output Rise Characteristic
Vin(nom); Full Load

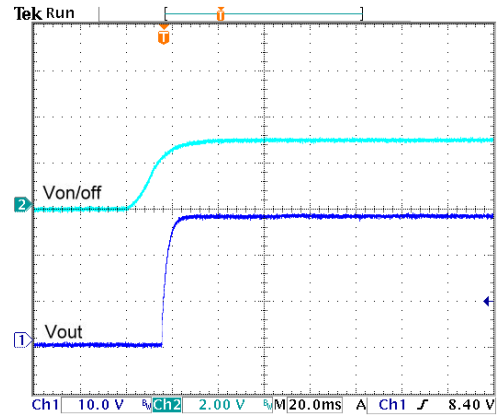

Using ON/OFF Voltage Start-Up and Output Rise Characteristic
Vin(nom); Full Load

Characteristic Curves (Continued)

All test conditions are at 25°C. The figures are for DPX40-24S3P3

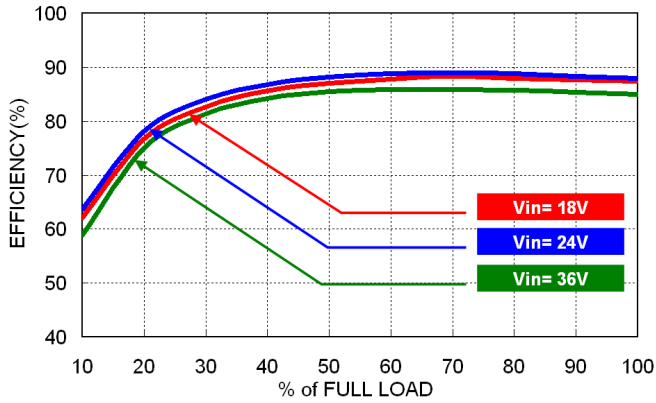

Efficiency versus Output Load

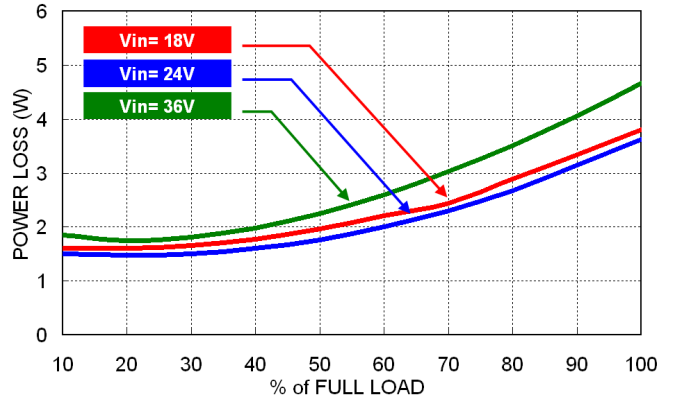

Power Dissipation versus Output Load

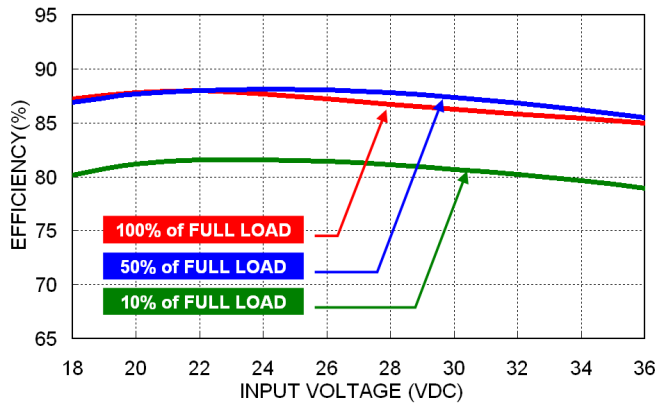

Efficiency versus Input Voltage

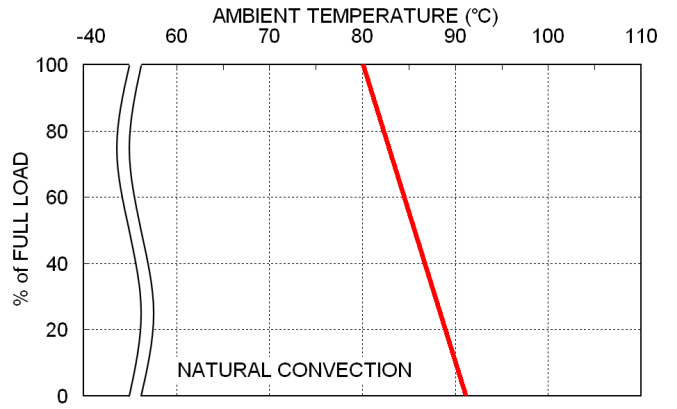

Derating Output Current versus Ambient Temperature and Airflow
Vin(nom)

Characteristic Curves (Continued)

All test conditions are at 25°C. The figures are for DPX40-24S3P3

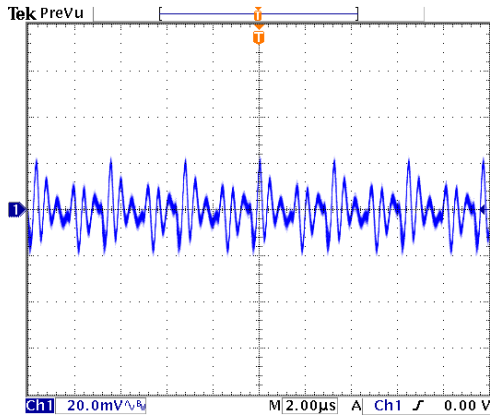

Typical Output Ripple and Noise.
Vin(nom); Full Load

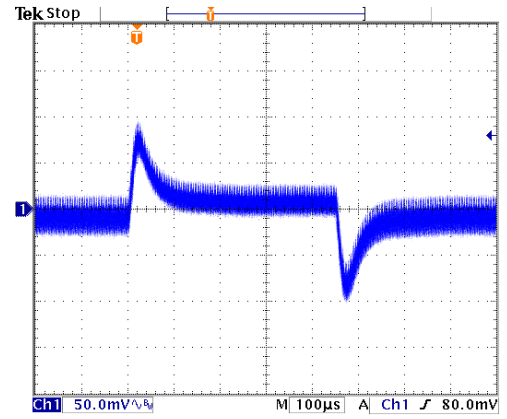

Transient Response to Dynamic Load Change from
100% to 75% to 100% of Full Load; Vin(nom)

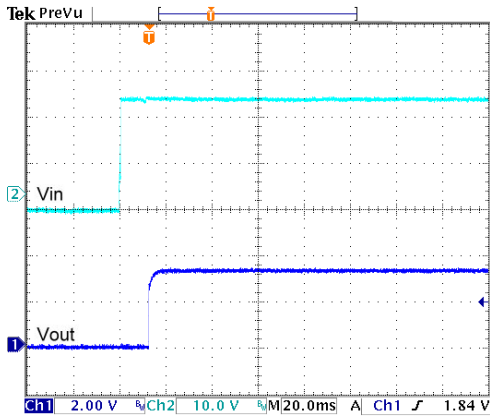

Typical Input Start-Up and Output Rise Characteristic
Vin(nom); Full Load

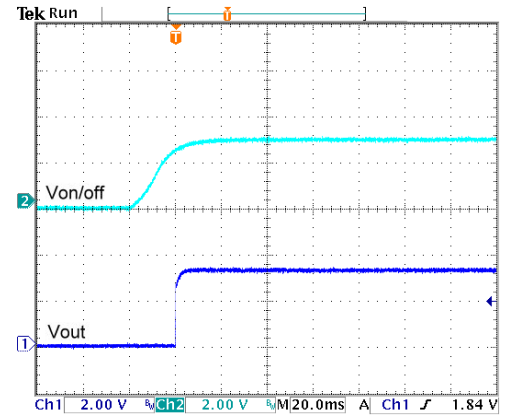

Using ON/OFF Voltage Start-Up and Output Rise Characteristic
Vin(nom); Full Load

Characteristic Curves (Continued)

All test conditions are at 25°C. The figures are for DPX40-24S05

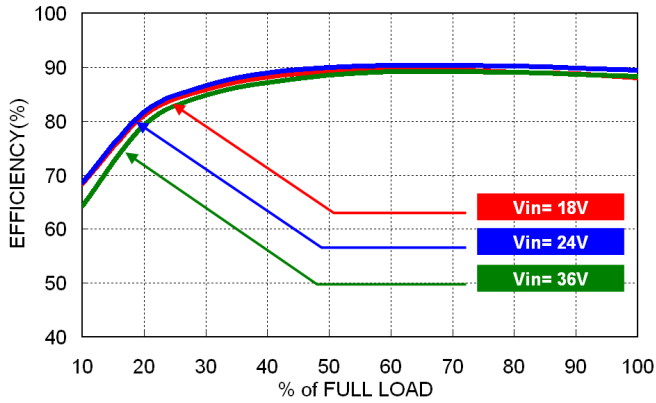

Efficiency versus Output Load

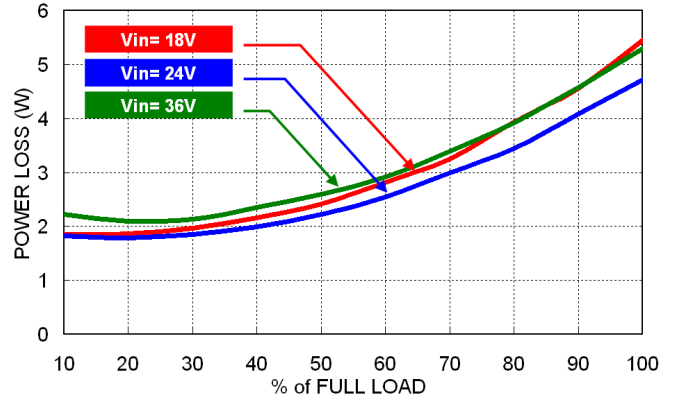

Power Dissipation versus Output Load

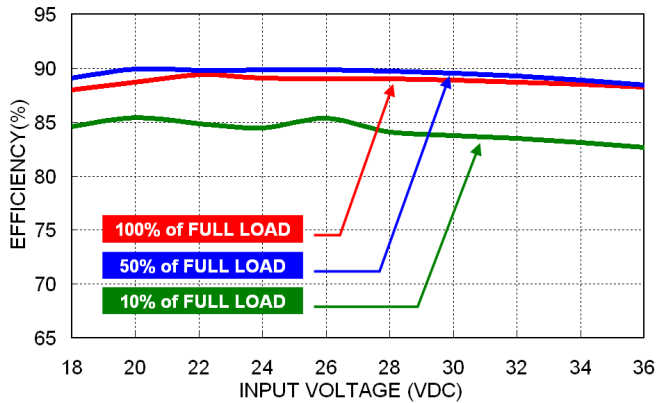

Efficiency versus Input Voltage

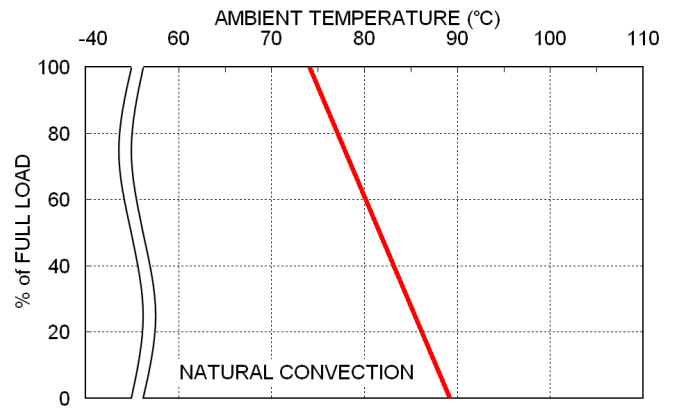

Derating Output Current versus Ambient Temperature and Airflow
Vin(nom)

Characteristic Curves (Continued)

All test conditions are at 25°C. The figures are for DPX40-24S05

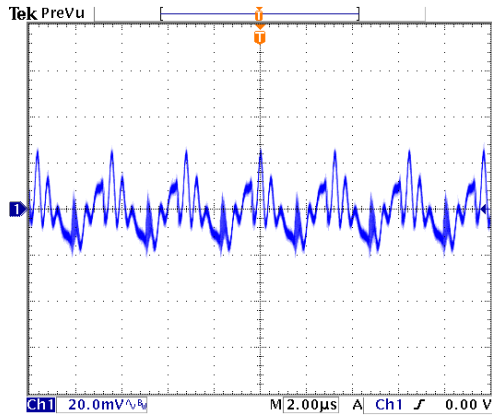

Typical Output Ripple and Noise.
Vin(nom); Full Load

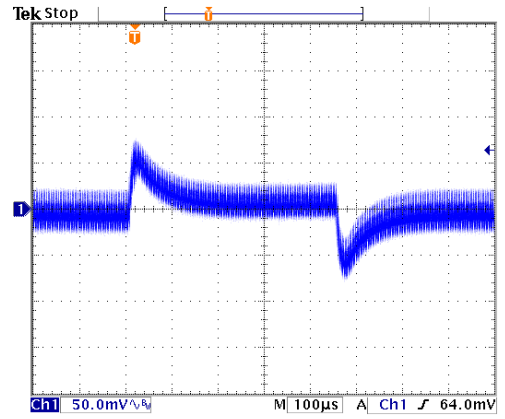

Transient Response to Dynamic Load Change from
100% to 75% to 100% of Full Load; Vin(nom)

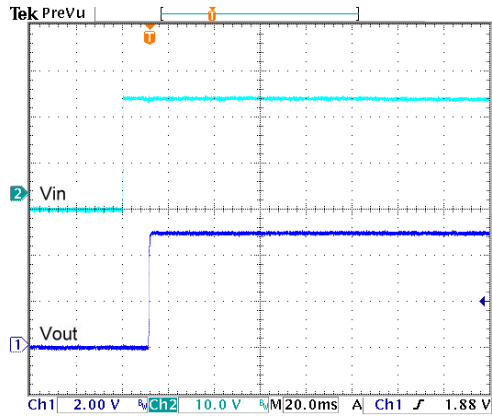

Typical Input Start-Up and Output Rise Characteristic
Vin(nom); Full Load

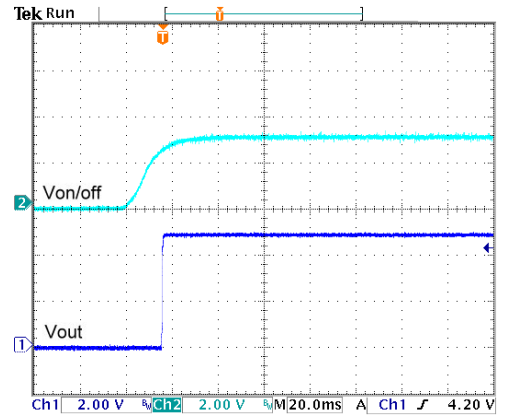

Using ON/OFF Voltage Start-Up and Output Rise Characteristic
Vin(nom); Full Load

Characteristic Curves (Continued)

All test conditions are at 25°C. The figures are for DPX40-24S12

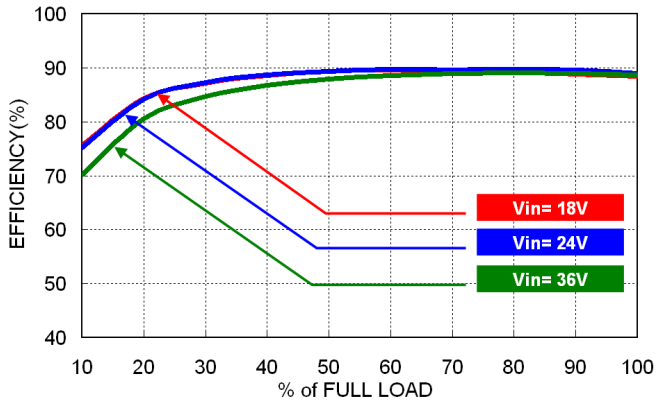

Efficiency versus Output Load

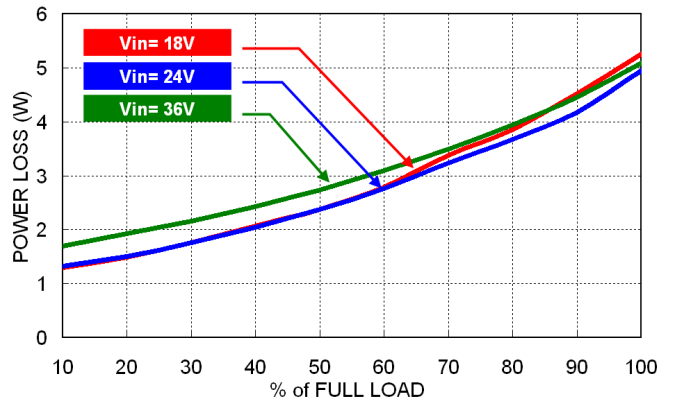

Power Dissipation versus Output Load

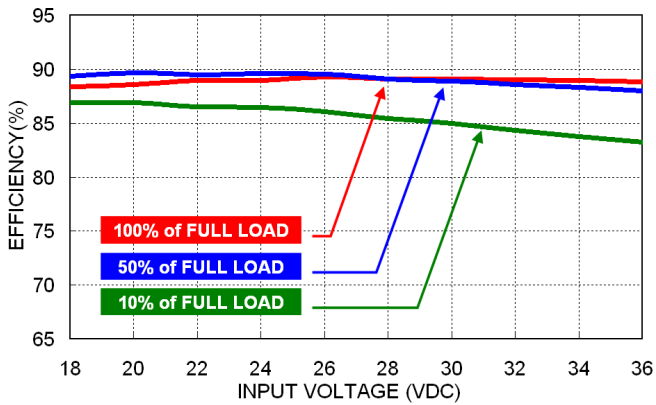

Efficiency versus Input Voltage

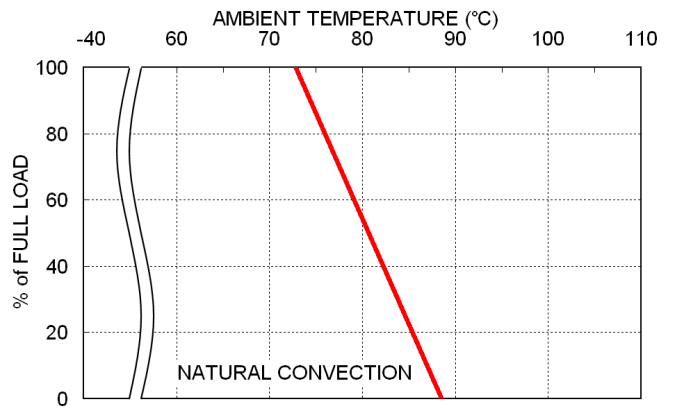

Derating Output Current versus Ambient Temperature and Airflow
Vin(nom)

Characteristic Curves (Continued)

All test conditions are at 25°C. The figures are for DPX40-24S12

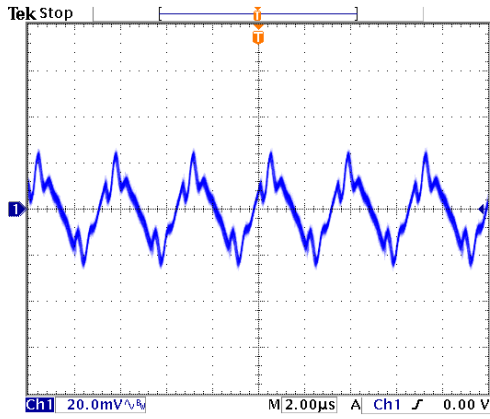

Typical Output Ripple and Noise.
Vin(nom); Full Load

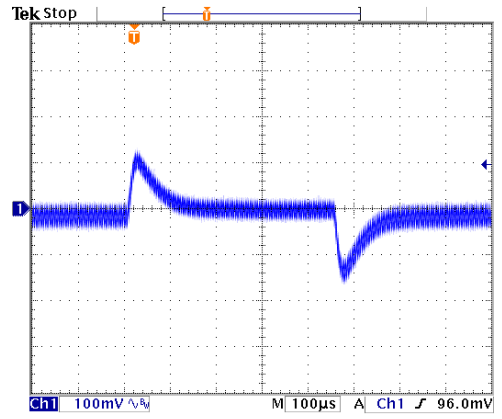

Transient Response to Dynamic Load Change from 100% to 75% to 100% of Full Load; Vin(nom)

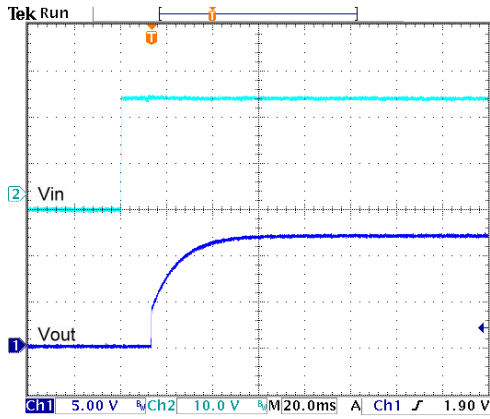

Typical Input Start-Up and Output Rise Characteristic
Vin(nom); Full Load

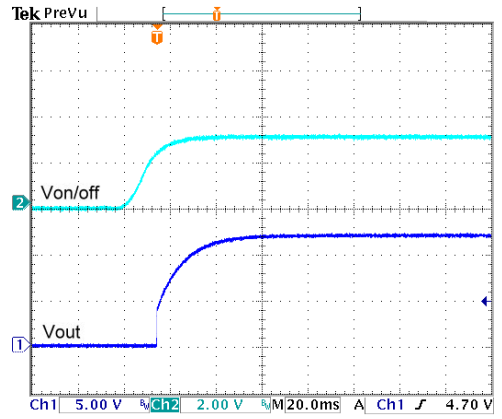

Using ON/OFF Voltage Start-Up and Output Rise Characteristic
Vin(nom); Full Load

Characteristic Curves (Continued)

All test conditions are at 25°C. The figures are for DPX40-24S15

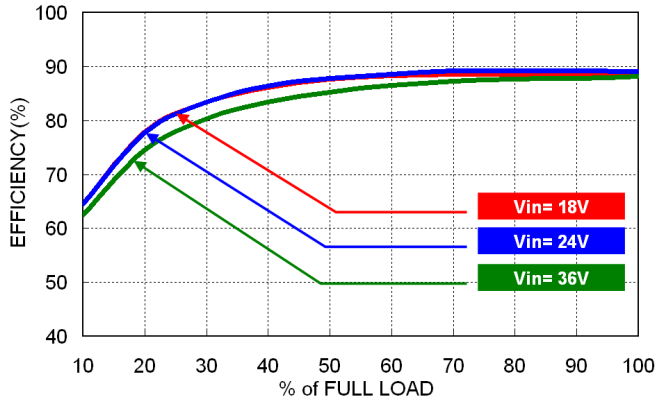

Efficiency versus Output Load

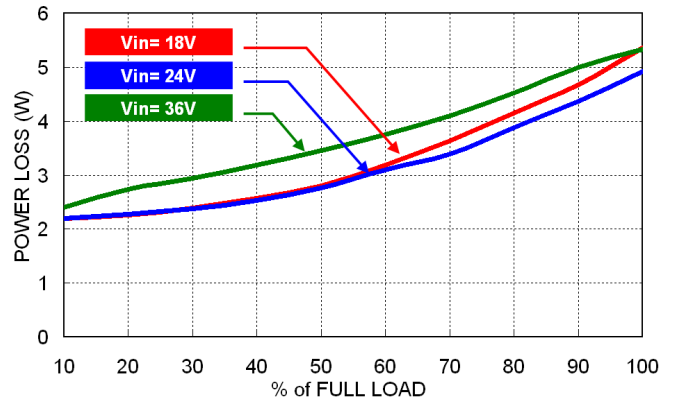

Power Dissipation versus Output Load

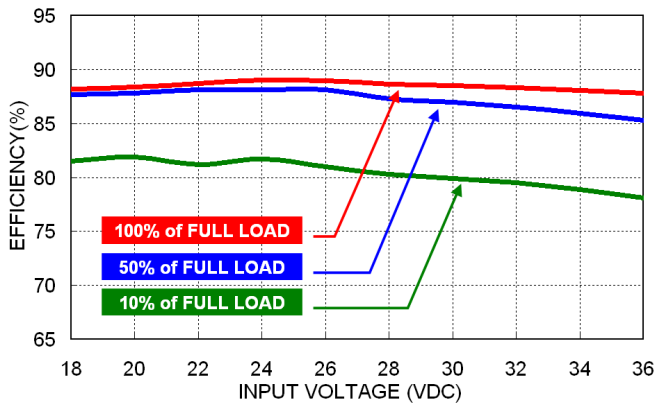

Efficiency versus Input Voltage

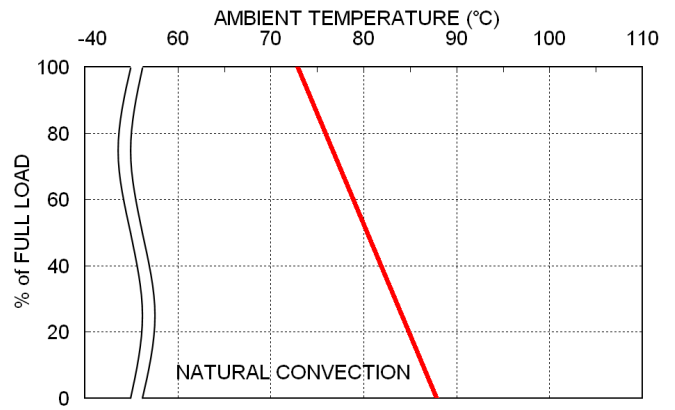

Derating Output Current versus Ambient Temperature and Airflow
Vin(nom)

Characteristic Curves (Continued)

All test conditions are at 25°C. The figures are for DPX40-24S15

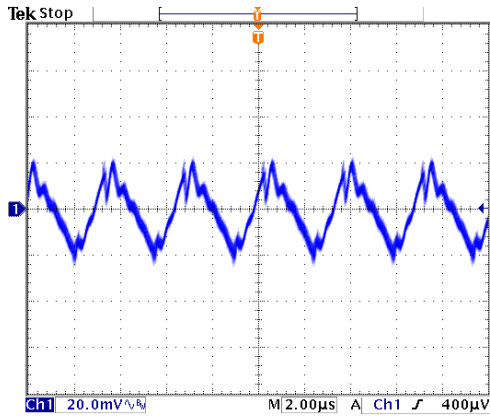

Typical Output Ripple and Noise.
Vin(nom); Full Load

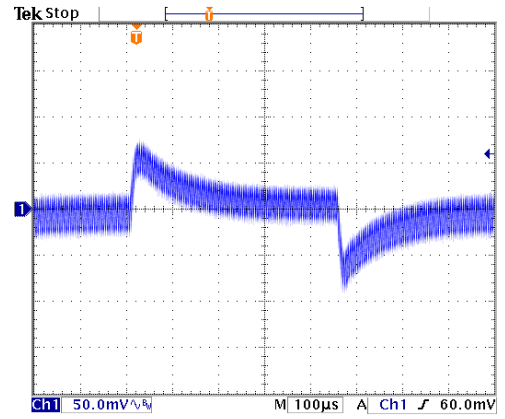

Transient Response to Dynamic Load Change from
100% to 75% to 100% of Full Load; Vin(nom)

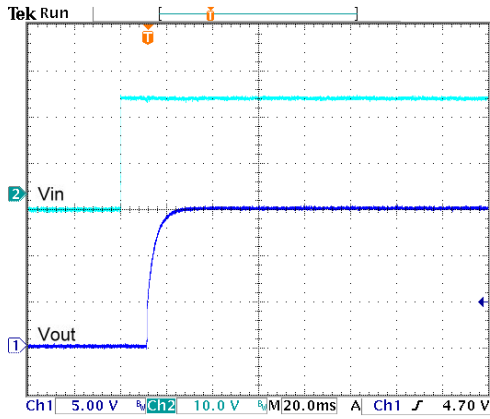

Typical Input Start-Up and Output Rise Characteristic
Vin(nom); Full Load

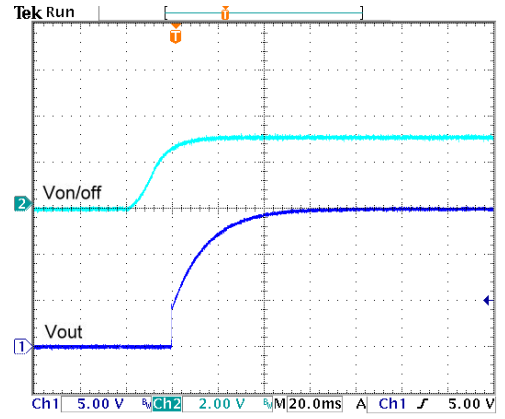

Using ON/OFF Voltage Start-Up and Output Rise Characteristic
Vin(nom); Full Load

Characteristic Curves (Continued)

All test conditions are at 25°C. The figures are for DPX40-24S24

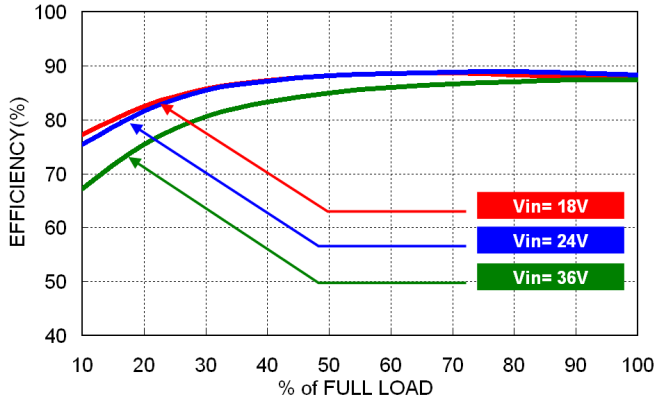

Efficiency versus Output Load

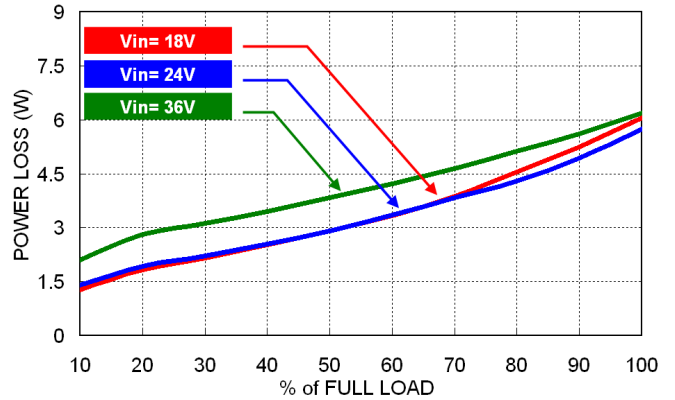

Power Dissipation versus Output Load

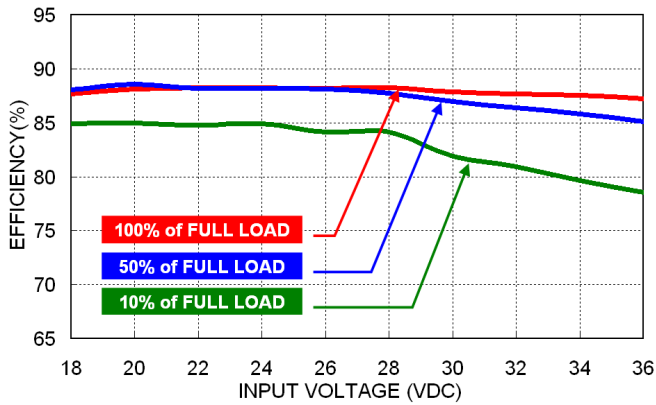

Efficiency versus Input Voltage

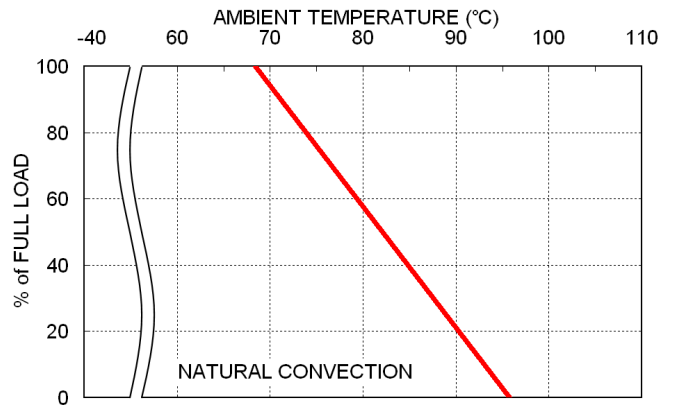

Derating Output Current versus Ambient Temperature and Airflow Vin(nom)

Characteristic Curves (Continued)

All test conditions are at 25°C. The figures are for DPX40-24S24

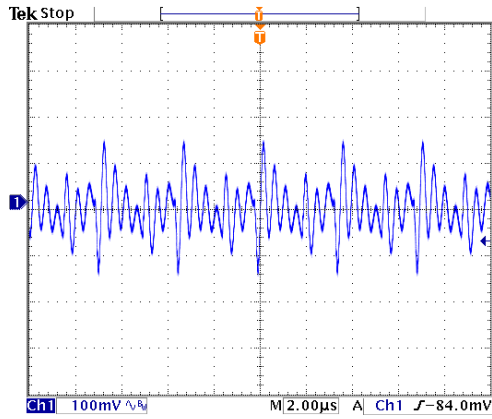

Typical Output Ripple and Noise.
Vin(nom); Full Load

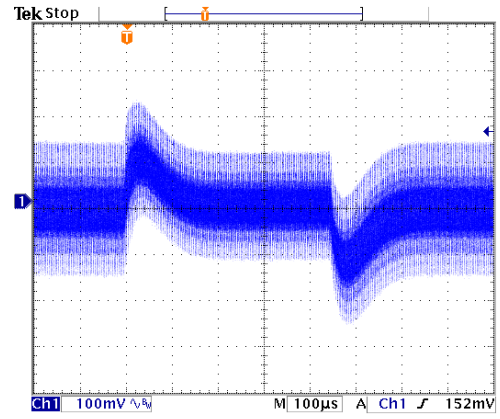

Transient Response to Dynamic Load Change from
100% to 75% to 100% of Full Load; Vin(nom)

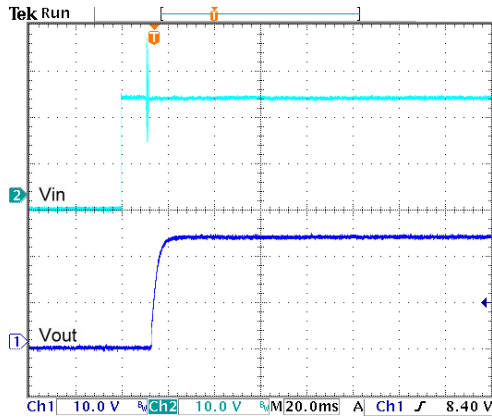

Typical Input Start-Up and Output Rise Characteristic
Vin(nom); Full Load

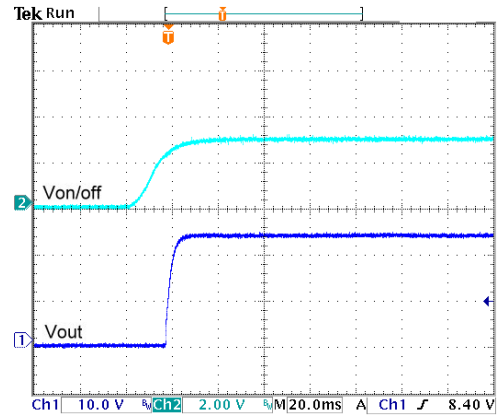

Using ON/OFF Voltage Start-Up and Output Rise Characteristic
Vin(nom); Full Load

Characteristic Curves (Continued)

All test conditions are at 25°C. The figures are for DPX40-24S28

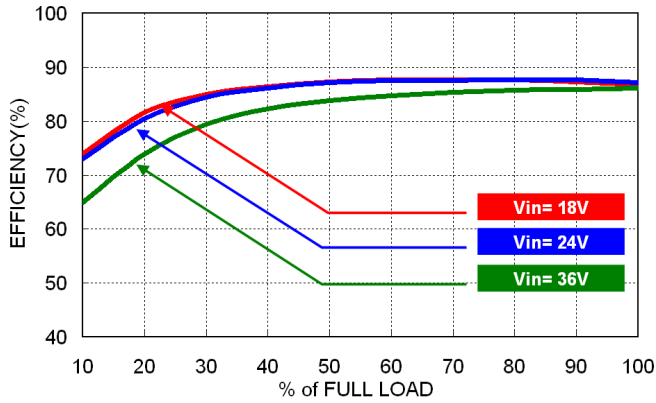

Efficiency versus Output Load

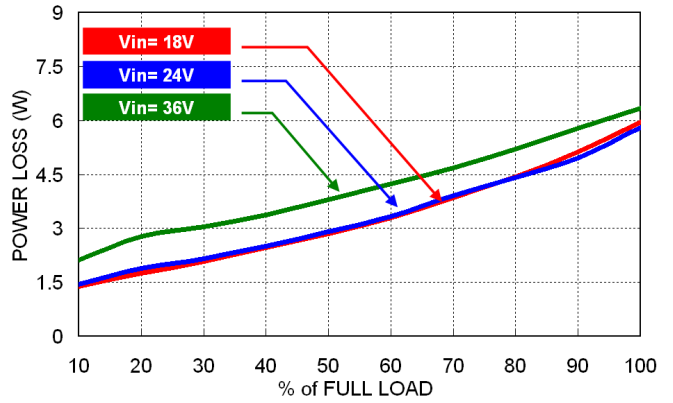

Power Dissipation versus Output Load

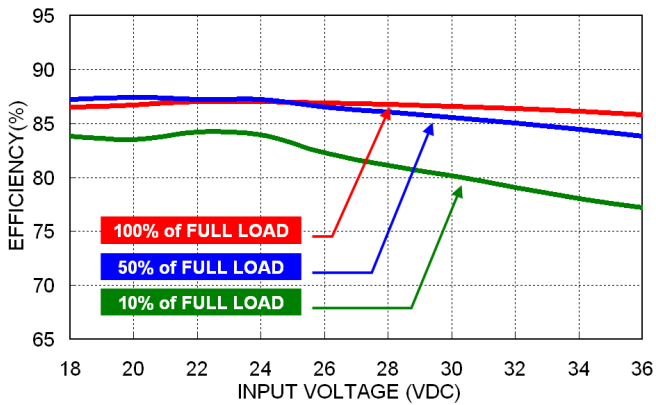

Efficiency versus Input Voltage

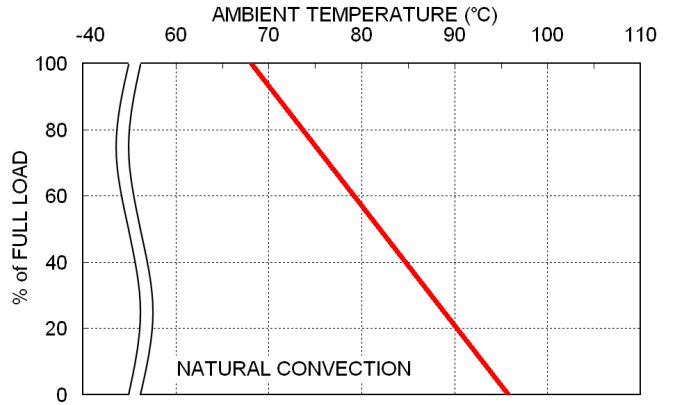

Derating Output Current versus Ambient Temperature and Airflow Vin(nom)

Characteristic Curves (Continued)

All test conditions are at 25°C. The figures are for DPX40-24S28

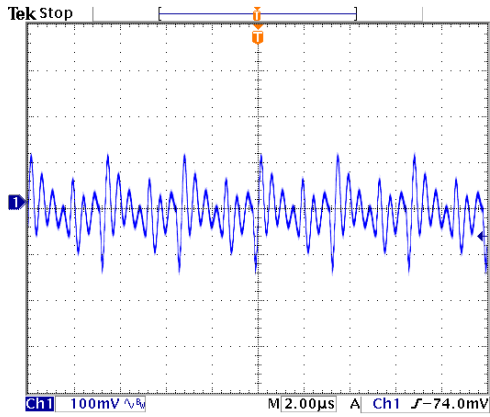

Typical Output Ripple and Noise.
Vin(nom); Full Load

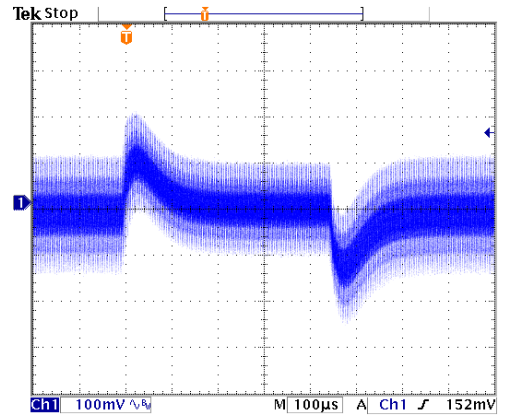

Transient Response to Dynamic Load Change from
100% to 75% to 100% of Full Load; Vin(nom)

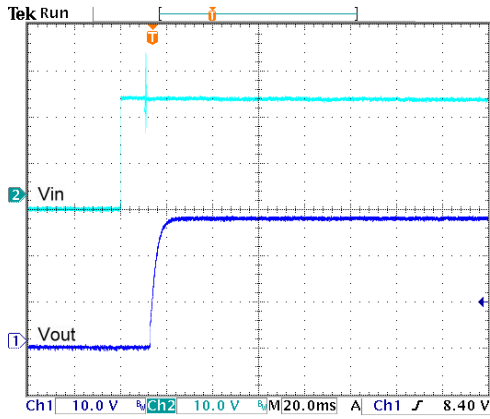

Typical Input Start-Up and Output Rise Characteristic
Vin(nom); Full Load

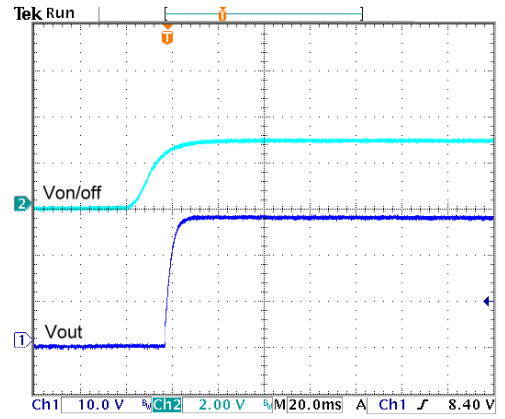

Using ON/OFF Voltage Start-Up and Output Rise Characteristic
Vin(nom); Full Load

Characteristic Curves (Continued)

All test conditions are at 25°C. The figures are for DPX40-48S3P3

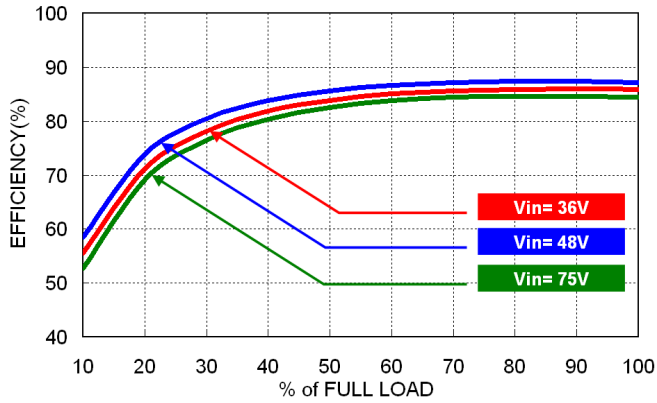

Efficiency versus Output Load

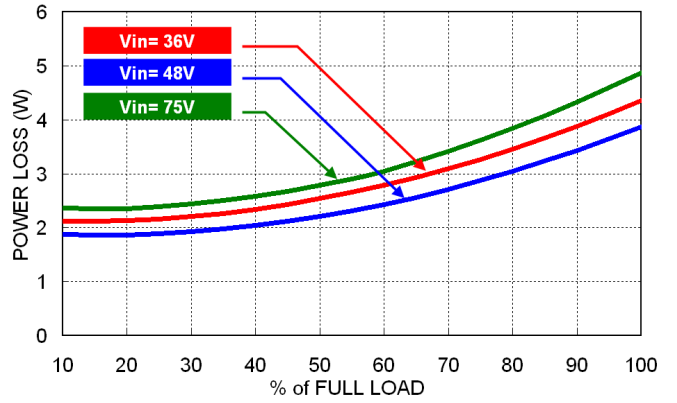

Power Dissipation versus Output Load

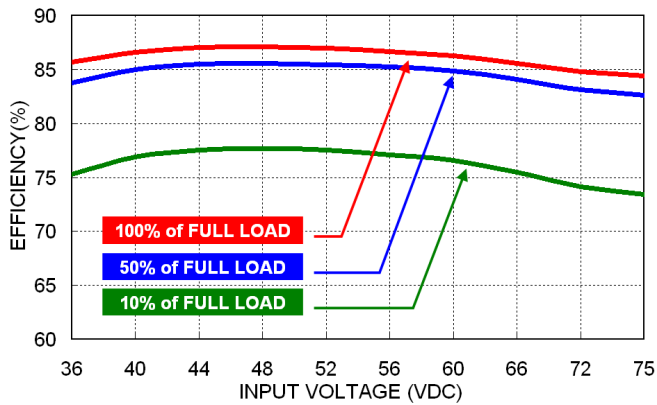

Efficiency versus Input Voltage

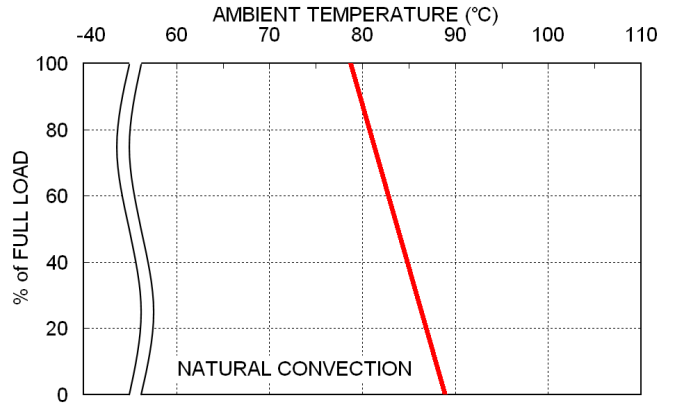

Derating Output Current versus Ambient Temperature and Airflow Vin(nom)

Characteristic Curves (Continued)

All test conditions are at 25°C. The figures are for DPX40-48S3P3

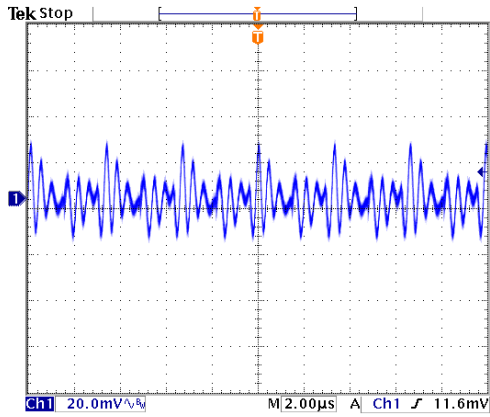

Typical Output Ripple and Noise.
Vin(nom); Full Load

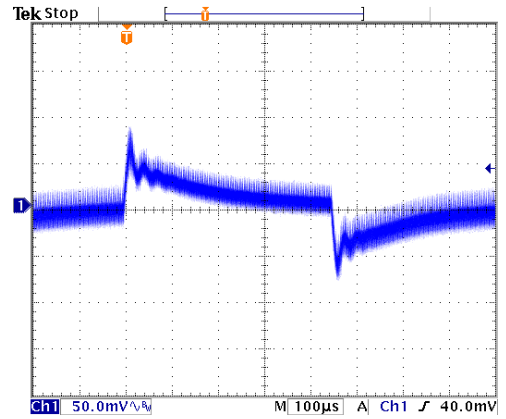

Transient Response to Dynamic Load Change from
100% to 75% to 100% of Full Load; Vin(nom)

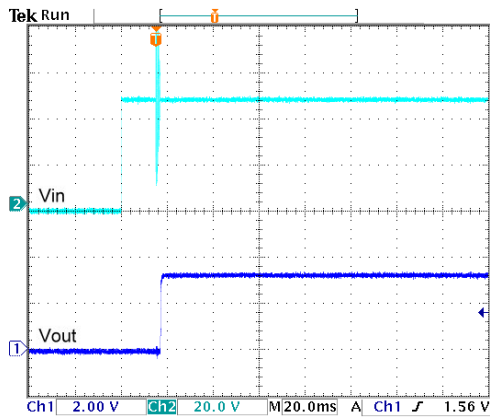

Typical Input Start-Up and Output Rise Characteristic
Vin(nom); Full Load

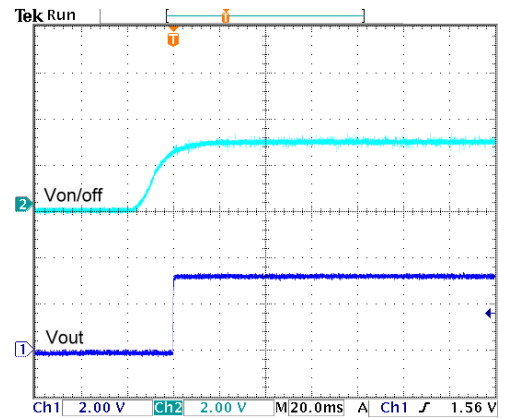

Using ON/OFF Voltage Start-Up and Output Rise Characteristic
Vin(nom); Full Load

Characteristic Curves (Continued)

All test conditions are at 25°C. The figures are for DPX40-48S05

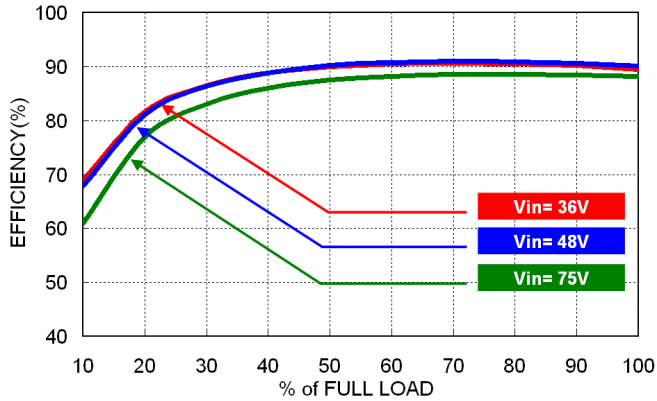

Efficiency versus Output Load

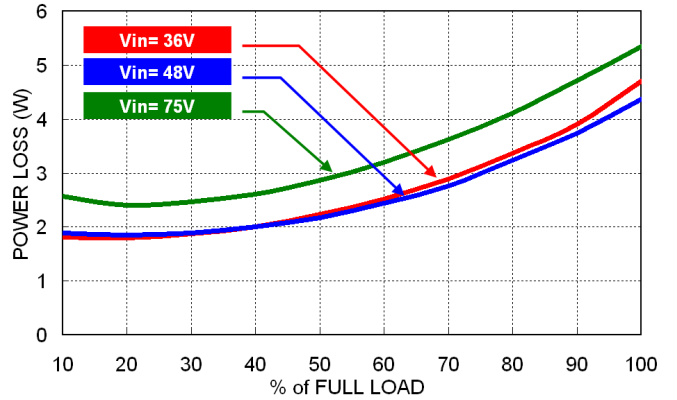

Power Dissipation versus Output Load

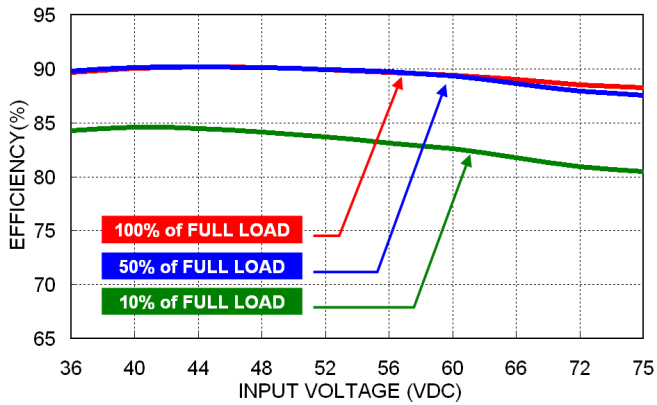

Efficiency versus Input Voltage

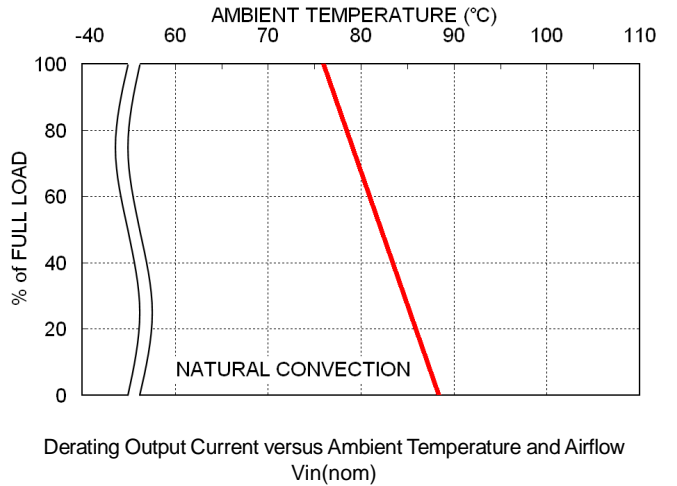

Derating Output Current versus Ambient Temperature and Airflow Vin(nom)

Characteristic Curves (Continued)

All test conditions are at 25°C. The figures are for DPX40-48S05

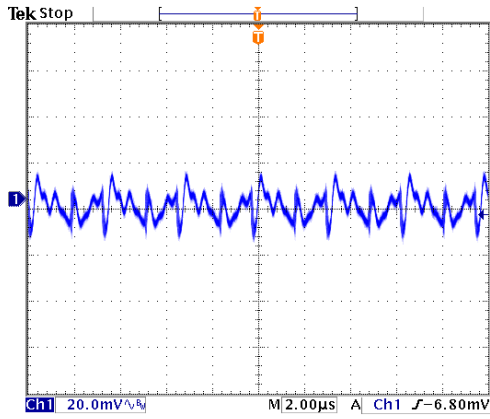

Typical Output Ripple and Noise.
Vin(nom); Full Load

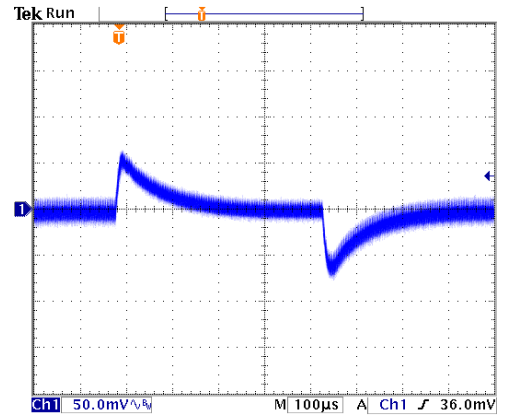

Transient Response to Dynamic Load Change from
100% to 75% to 100% of Full Load; Vin(nom)

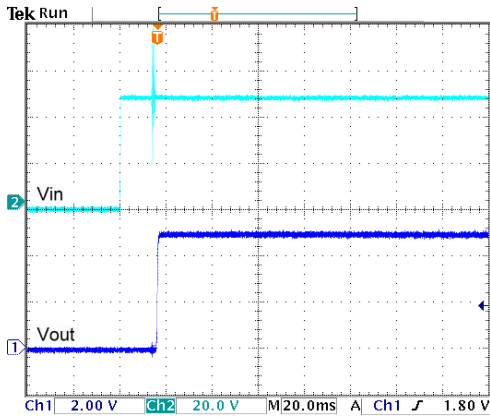

Typical Input Start-Up and Output Rise Characteristic
Vin(nom); Full Load

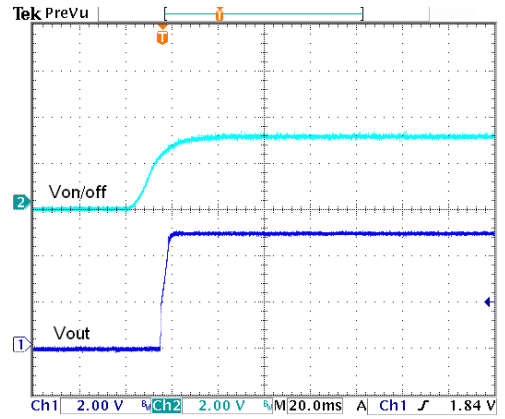

Using ON/OFF Voltage Start-Up and Output Rise Characteristic
Vin(nom); Full Load

Characteristic Curves (Continued)

All test conditions are at 25°C. The figures are for DPX40-48S12

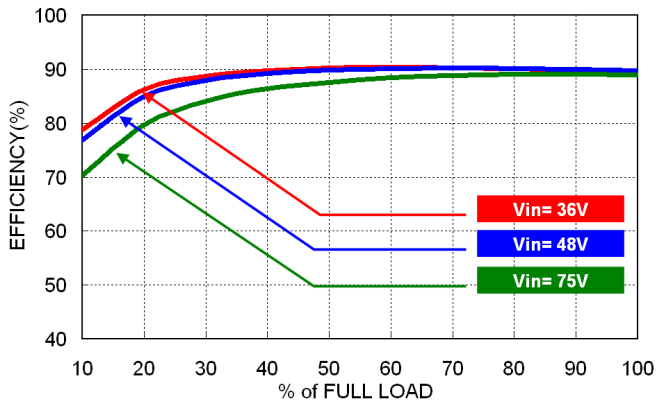

Efficiency versus Output Load

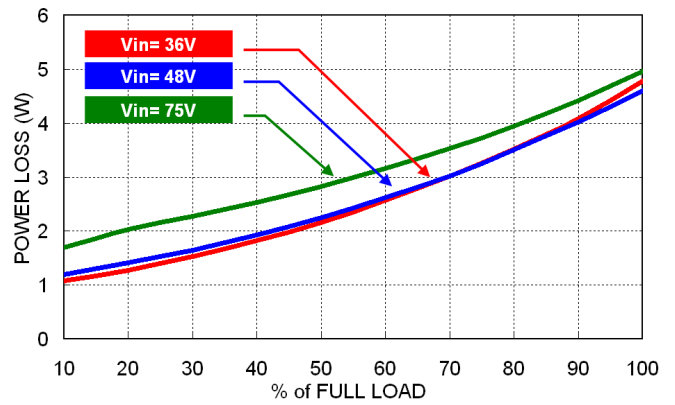

Power Dissipation versus Output Load

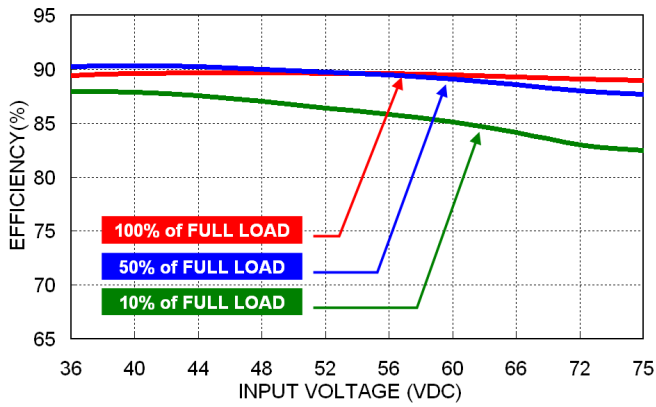

Efficiency versus Input Voltage

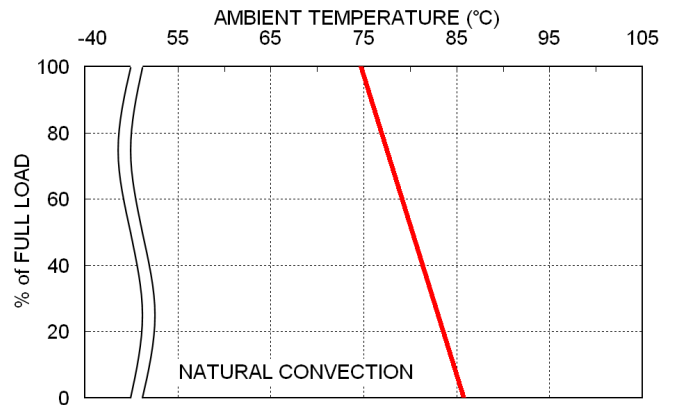

Derating Output Current versus Ambient Temperature and Airflow Vin(nom)

Characteristic Curves (Continued)

All test conditions are at 25°C. The figures are for DPX40-48S12

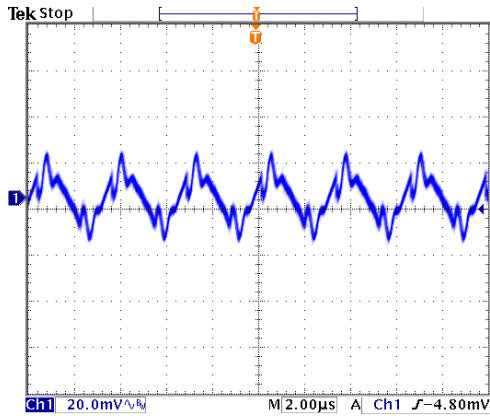

Typical Output Ripple and Noise.
Vin(nom); Full Load

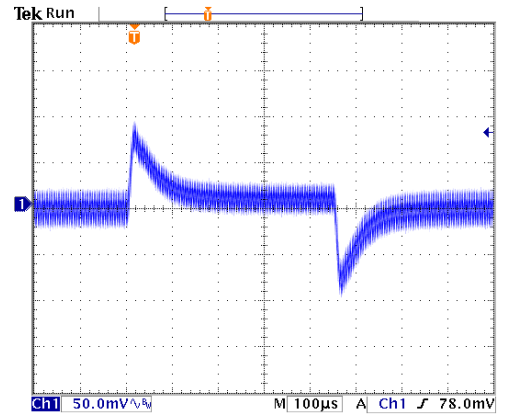

Transient Response to Dynamic Load Change from
100% to 75% to 100% of Full Load; Vin(nom)

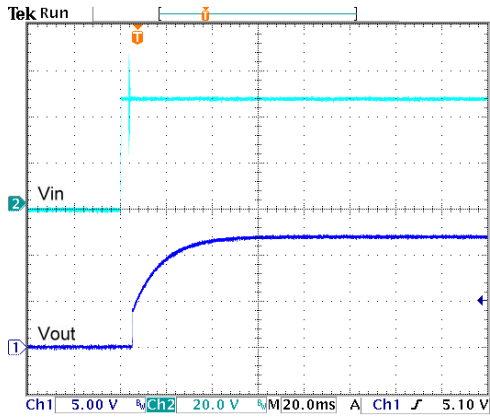

Typical Input Start-Up and Output Rise Characteristic
Vin(nom); Full Load

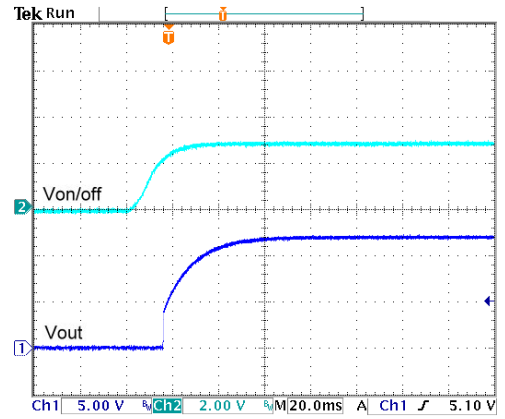

Using ON/OFF Voltage Start-Up and Output Rise Characteristic
Vin(nom); Full Load

Characteristic Curves (Continued)

All test conditions are at 25°C. The figures are for DPX40-48S15

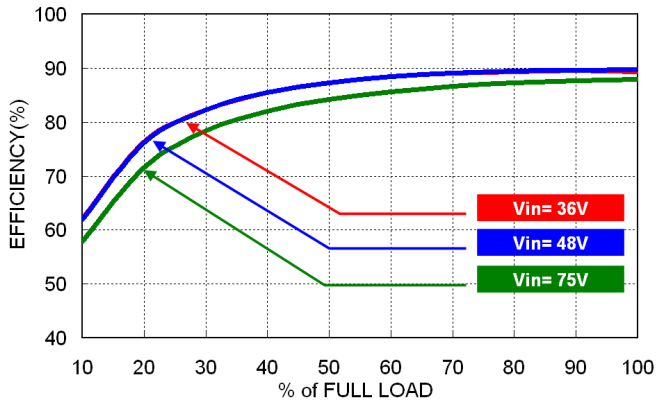

Efficiency versus Output Load

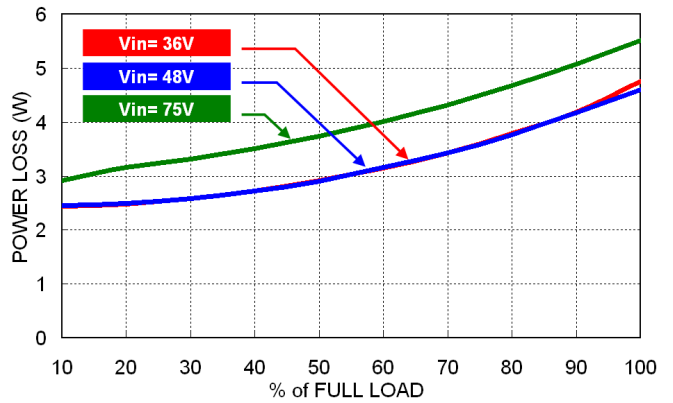

Power Dissipation versus Output Load

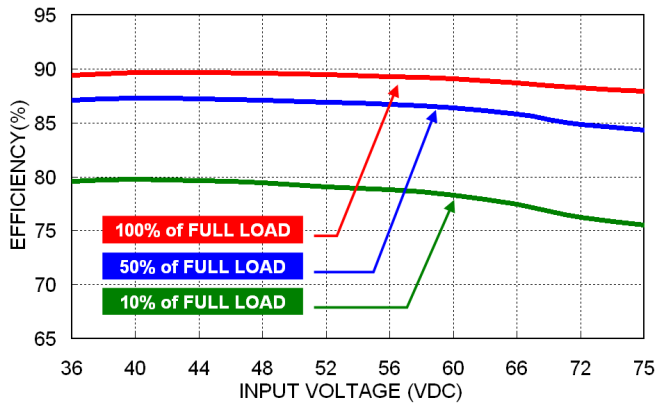

Efficiency versus Input Voltage

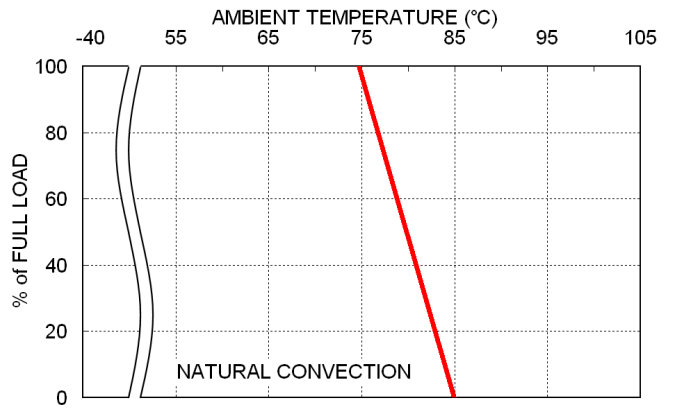

Derating Output Current versus Ambient Temperature and Airflow Vin(nom)

Characteristic Curves (Continued)

All test conditions are at 25°C. The figures are for DPX40-48S15

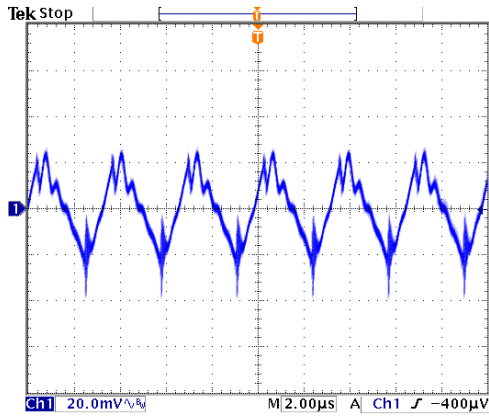

Typical Output Ripple and Noise.
Vin(nom); Full Load

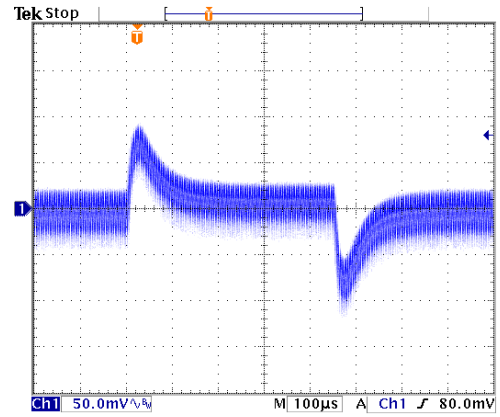

Transient Response to Dynamic Load Change from
100% to 75% to 100% of Full Load; Vin(nom)

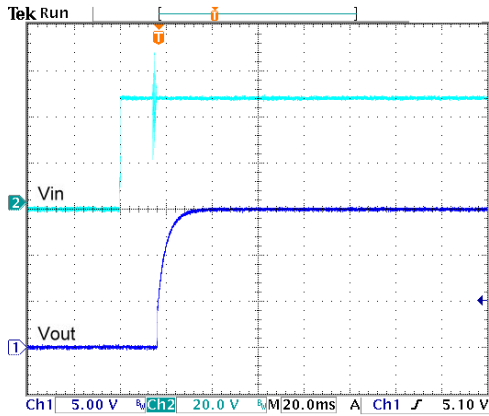

Typical Input Start-Up and Output Rise Characteristic
Vin(nom); Full Load

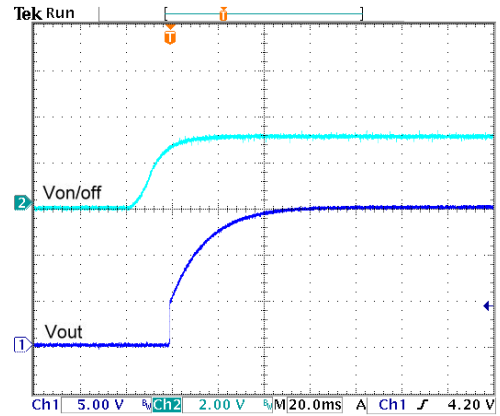

Using ON/OFF Voltage Start-Up and Output Rise Characteristic
Vin(nom); Full Load

Characteristic Curves (Continued)

All test conditions are at 25°C. The figures are for DPX40-48S24

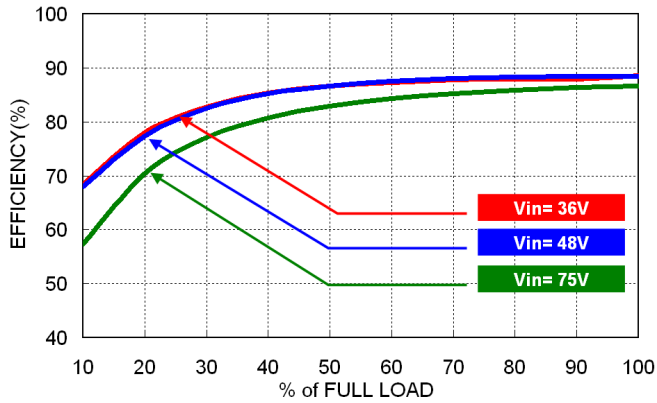

Efficiency versus Output Load

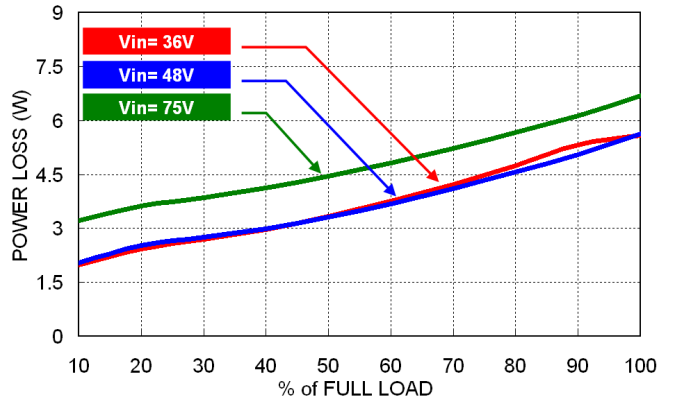

Power Dissipation versus Output Load

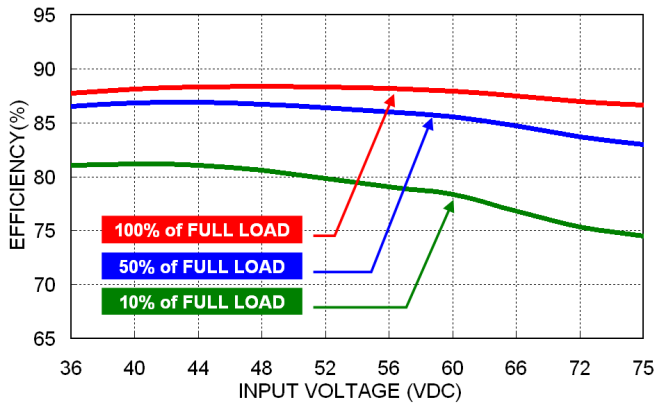

Efficiency versus Input Voltage

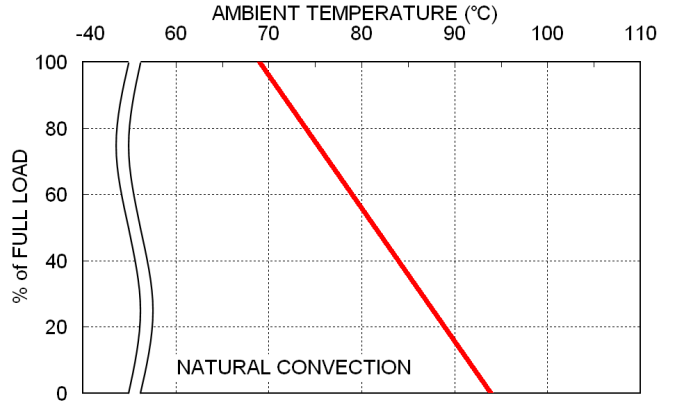

Derating Output Current versus Ambient Temperature and Airflow Vin(nom)

Characteristic Curves (Continued)

All test conditions are at 25°C. The figures are for DPX40-48S24

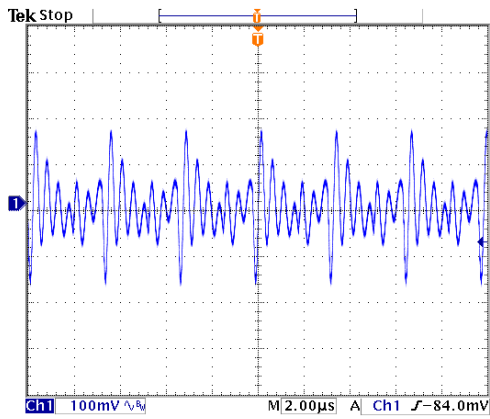

Typical Output Ripple and Noise.
Vin(nom); Full Load

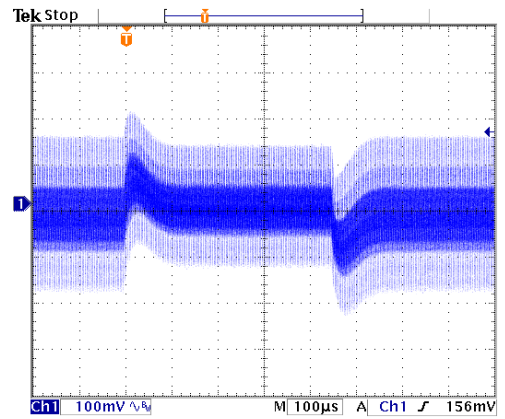

Transient Response to Dynamic Load Change from
100% to 75% to 100% of Full Load; Vin(nom)

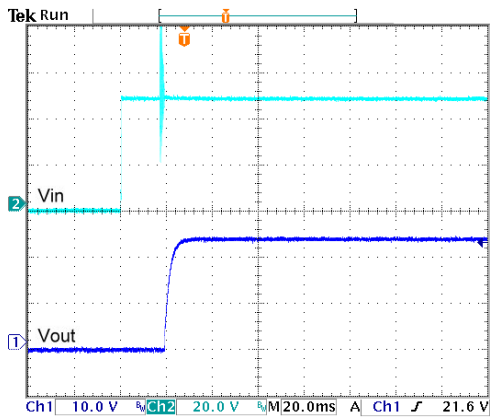

Typical Input Start-Up and Output Rise Characteristic
Vin(nom); Full Load

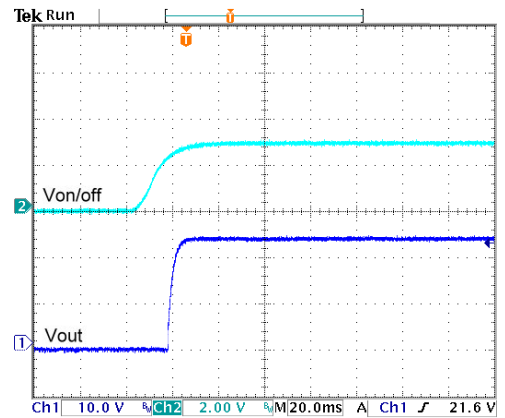

Using ON/OFF Voltage Start-Up and Output Rise Characteristic
Vin(nom); Full Load

Characteristic Curves (Continued)

All test conditions are at 25°C. The figures are for DPX40-48S28

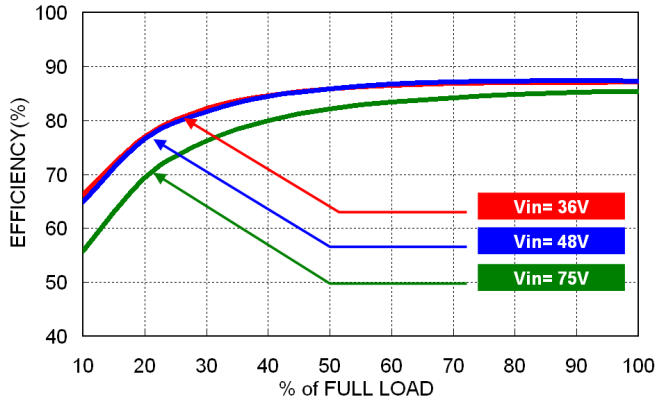

Efficiency versus Output Load

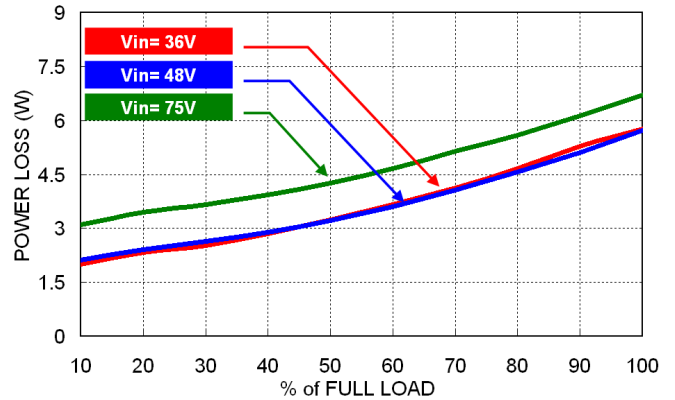

Power Dissipation versus Output Load

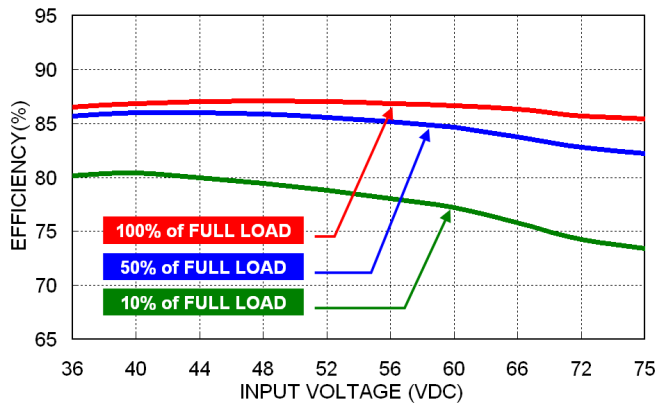

Efficiency versus Input Voltage

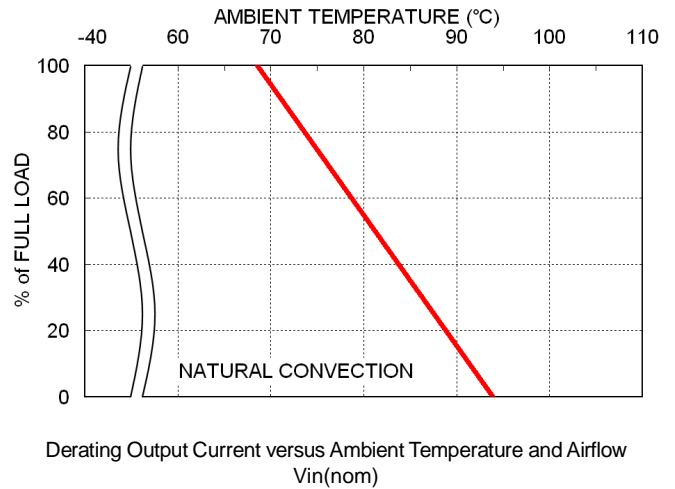

Derating Output Current versus Ambient Temperature and Airflow Vin(nom)

Characteristic Curves (Continued)

All test conditions are at 25°C. The figures are for DPX40-48S28

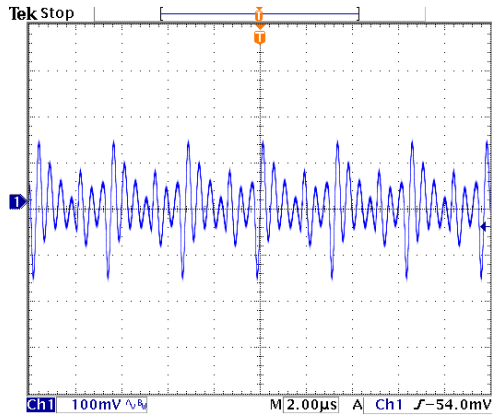

Typical Output Ripple and Noise.
Vin(nom); Full Load

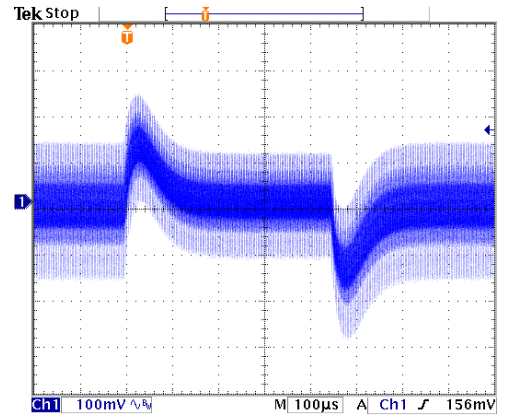

Transient Response to Dynamic Load Change from
100% to 75% to 100% of Full Load; Vin(nom)

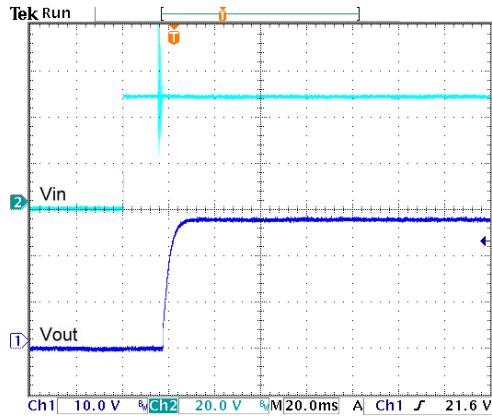

Typical Input Start-Up and Output Rise Characteristic
Vin(nom); Full Load

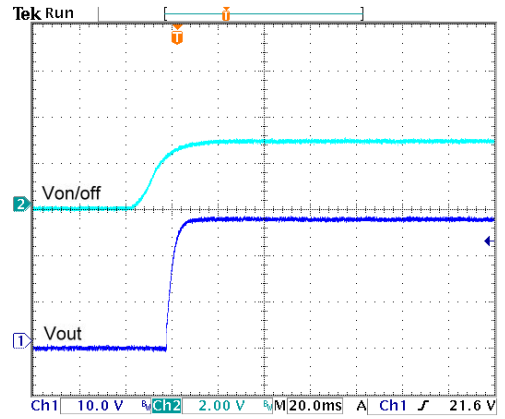

Using ON/OFF Voltage Start-Up and Output Rise Characteristic
Vin(nom); Full Load

Input Source Impedance

The power module should be connected to a low impedance input source. Highly inductive source impedance can affect the stability of the power module. The test configuration for the input reflected-ripple current measurement is shown below:

Input reflected-ripple current measurement setup

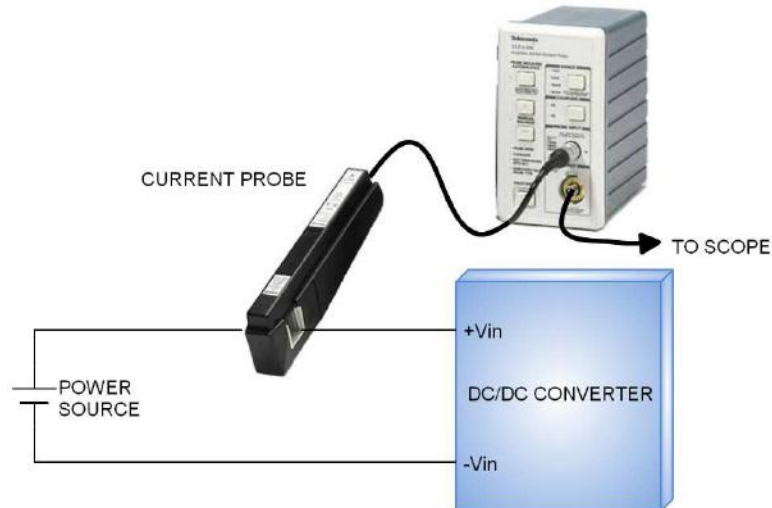

Output Over Current Protection

When excessive output currents occur in the system, circuit protection is required on all power supplies. Normally, overload current is maintained at approximately 150 percent of rated current for DPX40-xxSxx series.

Hiccup-mode is a method of operation in a power supply whose purpose is to protect the power supply from being damaged during an over-current fault condition. It also enables the power supply to restart when the fault is removed. There are other ways of protecting the power supply when it is over-loaded, such as the maximum current limiting or current fold-back methods.

One of the problems resulting from over current is that excessive heat may be generated in power devices; especially MOSFET and Schottky diodes and the temperature of those devices may exceed their specified limits. A protection mechanism has to be used to prevent those power devices from being damaged.

The operation of hiccup is as follows. When the current sense circuit sees an over-current event, the controller shuts off the power supply for a given time and then tries to start up the power supply again. If the over-load condition has been removed, the power supply will start up and operate normally; otherwise, the controller will see another over-current event and shut off the power supply again, repeating the previous cycle. Hiccup operation has none of the drawbacks of the other two protection methods, although its circuit is more complicated because it requires a timing circuit. The excess heat due to overload lasts for only a short duration in the hiccup cycle, hence the junction temperature of the power devices is much lower.

The hiccup operation can be done in various ways. For example, one can start hiccup operation any time an over-current event is detected; or prohibit hiccup during a designated start-up interval (usually a few milliseconds). The reason for the latter operation is that during start-up, the power supply needs to provide extra current to charge up the output capacitor. Thus the current demand during start-up is usually larger than during normal operation and it is easier for an over-current event to occur. If the power supply starts to hiccup once there is an over-current, it might never start up successfully. Hiccup mode protection will give the best protection for a power supply against over current situations, since it will limit the average current to the load at a low level, so reducing power dissipation and case temperature in the power devices.

Output Short Circuit Protection

Continuous and auto-recovery mode.

During an output short circuit, the converter shuts down. The average current during this condition will be very low.

Output Over Voltage Protection

The output over-voltage protection consists of output Zener diode that monitors the voltage on the output terminals. If the voltage on the output terminals exceeds the over-voltage protection threshold, then the Zener diode clamps the output voltage.

Remote On/off Control

The Ctrl Pin is used to turn the DC/DC power module on and off. The user must use a switch to control the logic voltage (high or low) level of the pin referenced to $-V_{in}$. The switch can be an open collector transistor, FET, or Photo-Coupler. The switch must be capable of sinking up to 1 mA at low-level logic voltage. A High-level logic of the Ctrl pin signal should be limited to a maximum voltage of 12V and a maximum current of 0.5 mA.

Remote ON/OFF Implementation

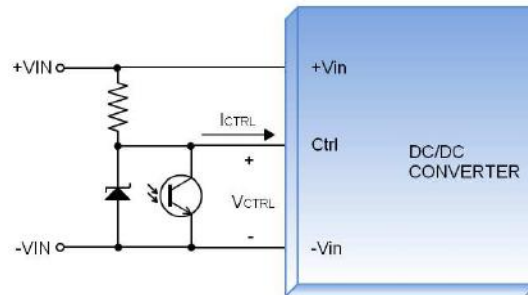
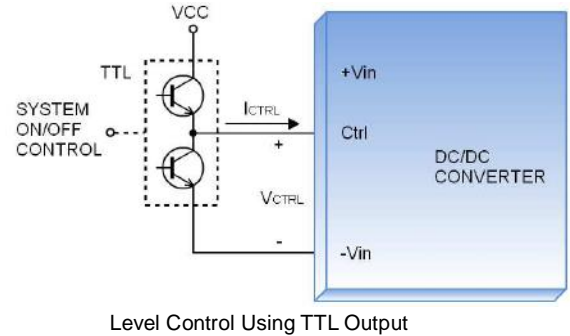
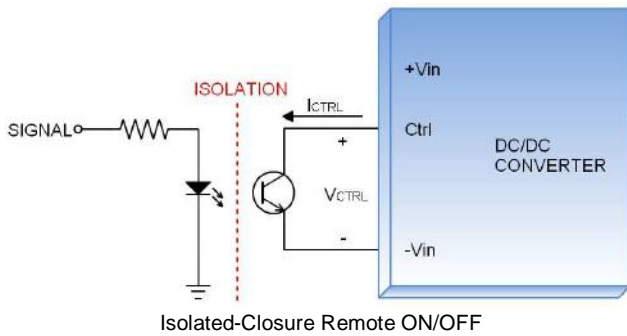

There are two remote control options available, positive logic (optional) and negative logic (optional)

- a. The positive logic structure turns on the DC/DC module when the Ctrl pin is at a high-logic level and turns the module off using a low-logic level.

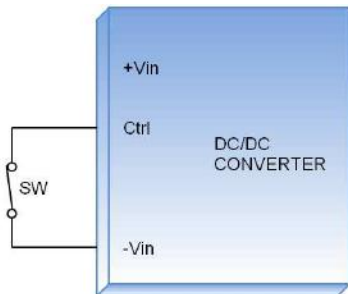

When DPX40-xxSxx-P module is turned off using a Low-logic level

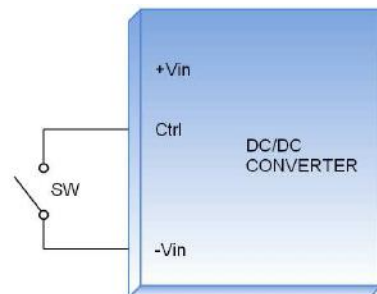

When DPX40-xxSxx-P module is turned on Using a High-logic level

- b. The negative logic structure turns on the DC/DC module when the Ctrl pin is at a low-logic level and turns the module off when using a high-level logic.

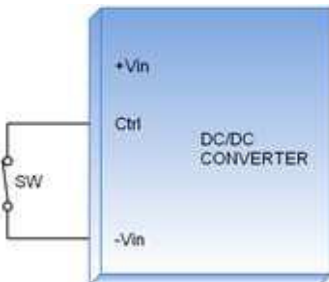

When DPX40-xxSxx-N module is turned on using a low – logic level

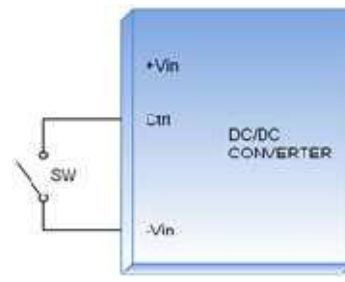

When DPX40-xxSxx-N module is turned off using a high – logic level

EMS Considerations

The DPX40-xxSxx series can meet Fast Transient EN61000-4-4 and Surge EN61000-4-5 performance criteria A. Please see the following schematic:

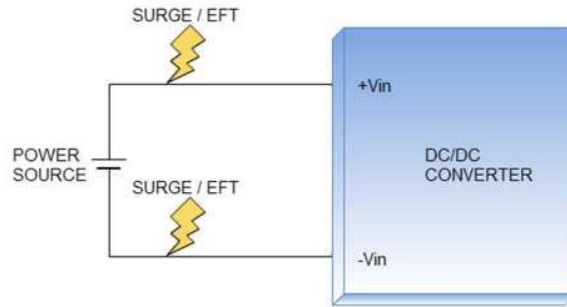

Mechanical Data

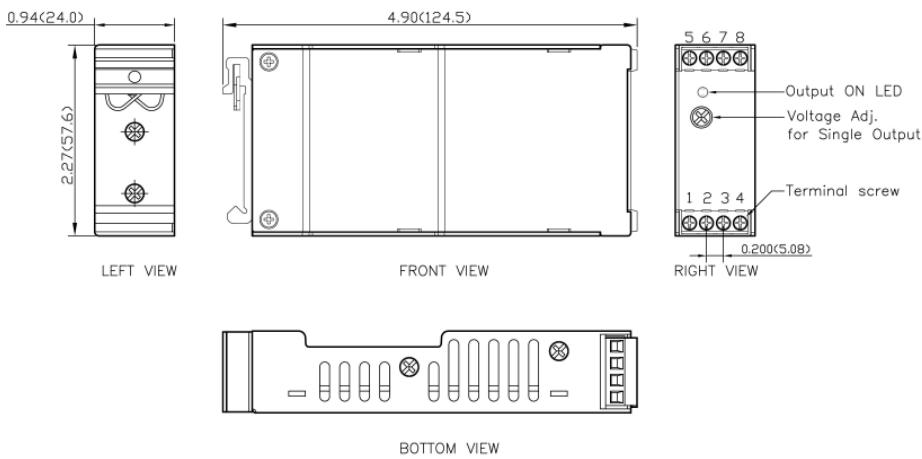

PINOUT

PIN	FUNCTION
1	Ctrl
2	-Vin
3	-Vin
4	+Vin
5	NC
6	-Vout
7	+Vout
8	NC

* NC : No Connection

* Screw terminals—wire range from 14 to 18 AWG

1. All dimensions in inch (mm)
2. Tolerance : X.XX±0.02 (X.X±0.5)
X.XXX±0.01 (X.XX±0.25)
3. Terminal screw locked torque :
MAX 2.5kgf-cm (0.25N-m)

Packaging Information

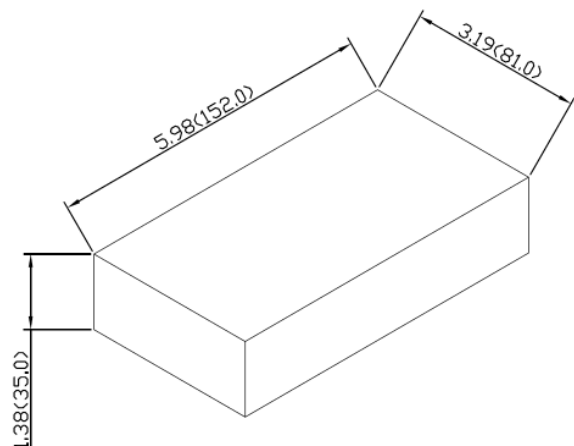
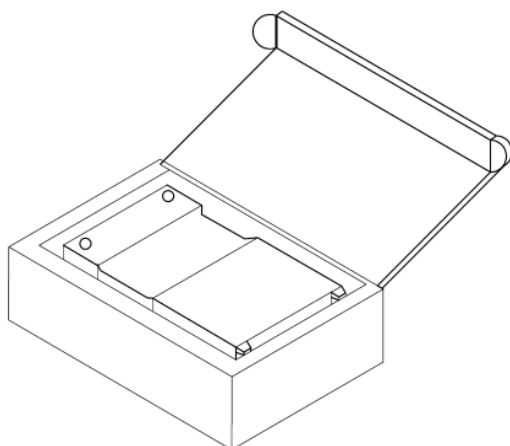

1PCS / BOX
All dimensions in mm

Part Number Structure

DPX40	-	48	S	05	-N
Series Name		Input Voltage (VDC)	Output Quantity	Output Voltage (VDC)	Remote Control options
		12: 9.5~18 24: 18~36 48: 36~75	S: Single	3P3: 3.3 05: 5 12: 12 15: 15 24: 24 28: 28	P: Positive logic N: Negative logic

Model Number	Input Range	Output Voltage	Output Current @ Full Load		Input Current @ No Load	Efficiency	Maximum Capacitor Load
	VDC		VDC	Min. Load (1) mA			
DPX40-12S3P3	9.5 ~ 18	3.3	0	8000	179	84	21000
DPX40-12S05	9.5 ~ 18	5	0	8000	232	84	13600
DPX40-12S12	9.5 ~ 18	12	0	3333	262	84	2360
DPX40-12S15	9.5 ~ 18	15	0	2666	320	85	1510
DPX40-12S24	9.5 ~ 18	24	144	1800	42	83	600
DPX40-12S28	9.5 ~ 18	28	112	1400	50	83	375
DPX40-24S3P3	18 ~ 36	3.3	0	8000	67	85	21000
DPX40-24S05	18 ~ 36	5	0	8000	82	87	13600
DPX40-24S12	18 ~ 36	12	0	3333	87	86	2360
DPX40-24S15	18 ~ 36	15	0	2666	92	87	1510
DPX40-24S24	18 ~ 36	24	144	1800	32	86	600
DPX40-24S28	18 ~ 36	28	112	1400	32	86	375
DPX40-48S3P3	36 ~ 75	3.3	0	8000	42	86	21000
DPX40-48S05	36 ~ 75	5	0	8000	44	88	13600
DPX40-48S12	36 ~ 75	12	0	3333	54	87	2360
DPX40-48S15	36 ~ 75	15	0	2666	57	87	1510
DPX40-48S24	36 ~ 75	24	144	1800	23	86	600
DPX40-48S28	36 ~ 75	28	112	1400	23	86	375

Note:

- The output requires a minimum load on the output to maintain specified regulation. Operation under no-load condition will not damage these devices; however, they may not meet all the listed specifications.

MTBF and Reliability

The MTBF for DPX40-xxSxx series of DC/DC converters has been calculated using MIL-HDBK-217F @ full load, operating temperature at 25°C. The resulting figure for MTBF is 8.080×10^5 hours.