



i7A Series DC/DC Power Module Series

9-60V Wide Input, 400 to 750 W Step Down Converter; Wide 1/16th Brick Footprint

i7A power modules perform step down voltage conversion from 12V, 24V or 48V buses. The i7A series utilizes a non-isolated power topology offering a low component count and a low cost structure with a superior level of performance. The open-frame, compact, design features a low profile and weight that allow for extremely flexible and robust manufacturing processes. The ultra-high efficiency allows for a high amount of usable power even in the most demanding thermal environments.

Features

- Size – 34mm x 36.8 mm x 12.7 mm (1.34 in. x 1.45 in. x 0.5 in.)
- Maximum weight 25g (0.88 oz.)
- Thru-hole pins 3.68mm (0.145")
- Industry standard 1/16th brick pin locations
- Up to 750W of output power in high ambient temperature, low airflow environments with minimal power derating
- Wide output voltage adjustment range
- Negative logic On/Off
- Constant switching frequency
- Remote Sense
- Full auto-recovery protection:
 - Input under voltage
 - Short circuit
 - Thermal limit
- ISO Certified manufacturing facilities

Optional Features

- Positive Logic On/Off
- Power Good
- Adjustable Over Current Protection Threshold
- Short 2.79mm (0.110") pin length
- Long 4.57mm (0.180") pin length
- Baseplate
- Heatsink

Ordering Information:

Product Identifier	Package Size	Platform	Input Voltage	Output Current	Units	Main Output Voltage	# of Outputs	Safety Class	Feature Set	RoHS indicator		
i	7	A	4W	033	A	033	V	-	0	01	-	R
TDK Lambda	34mm x 36.8mm	i7A	4W: 18-60 V 24 : 18-32 V 12 : 9-18V	033 – 33 A 045 – 45 A 060 – 60 A	Amps	3.3V	Single		See option table	R=RoHS Compliant		

Option Table:

Feature Set	Positive Logic On/Off	Negative Logic On/Off	0.145" Pin Length	With Baseplate	With Heatsink	Adjustable Current Limit
-000	Yes	-	Yes	-	-	-
-001	-	Yes	Yes	-	-	-
-003	No	Yes	Yes	-	-	Yes
-0C1	-	Yes	Yes	Yes	-	-
-0F1	-	Yes	Yes	-	Yes	-
-0C3	-	Yes	Yes	Yes	-	Yes
-0F3	-	Yes	Yes	-	Yes	Yes

Product Offering:

Code	Input Voltage (V)	Output Voltage (V)	Output Current (A)	Maximum Output Power (W)	Efficiency	Pins 9 & 10 Added
i7A4W033A033V	18 - 60	3.3 - 24	33	500	97%	No
i7A24045A033V	18 - 32	3.3 - 18	45	750	97%	Yes
i7A12060A008V	9 - 18	0.8 - 8	60	400	97%	Yes
i7A48020A033V**	28 - 60	3.3 - 32	20	500	97%	No

** Consult Technical Support for availability.

Typical Application Circuit (Standard model without output current limit adjust feature):

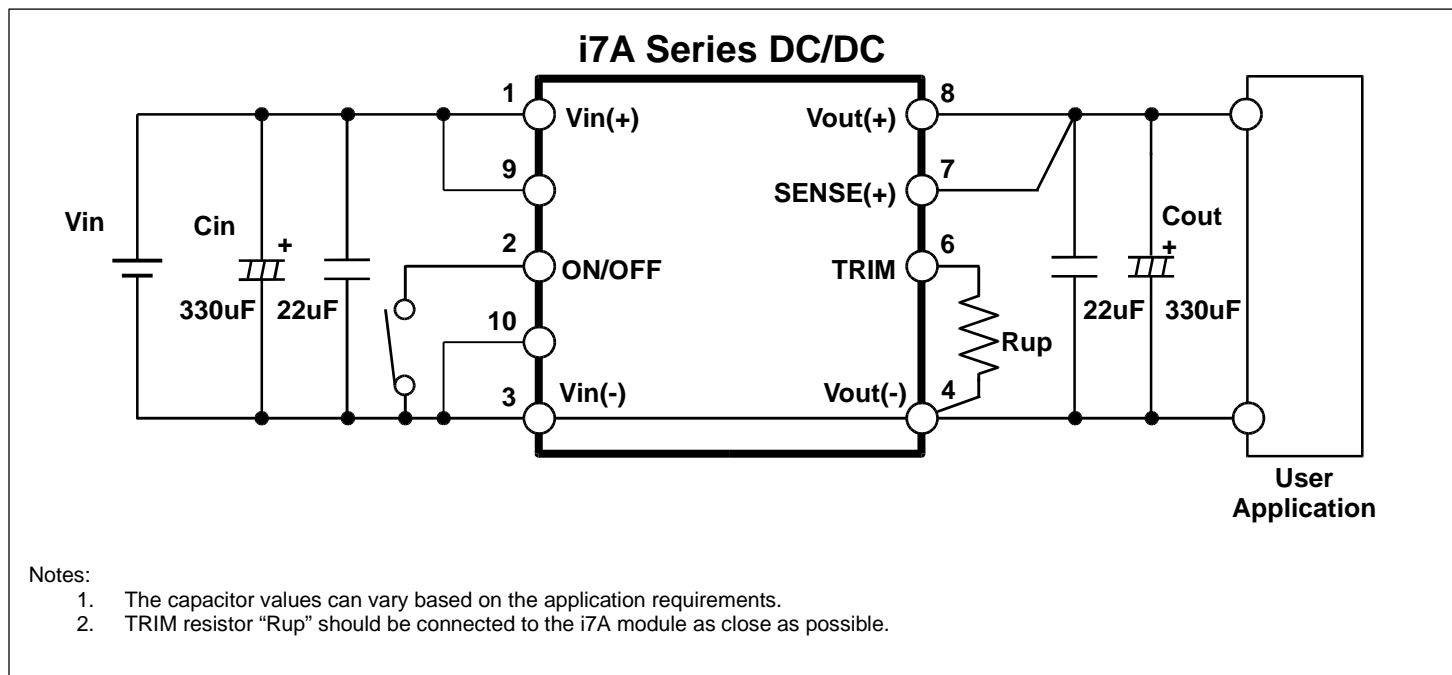

Typical Application Circuit (Suffix -xx3-R with output current limit (OCP) adjust feature):

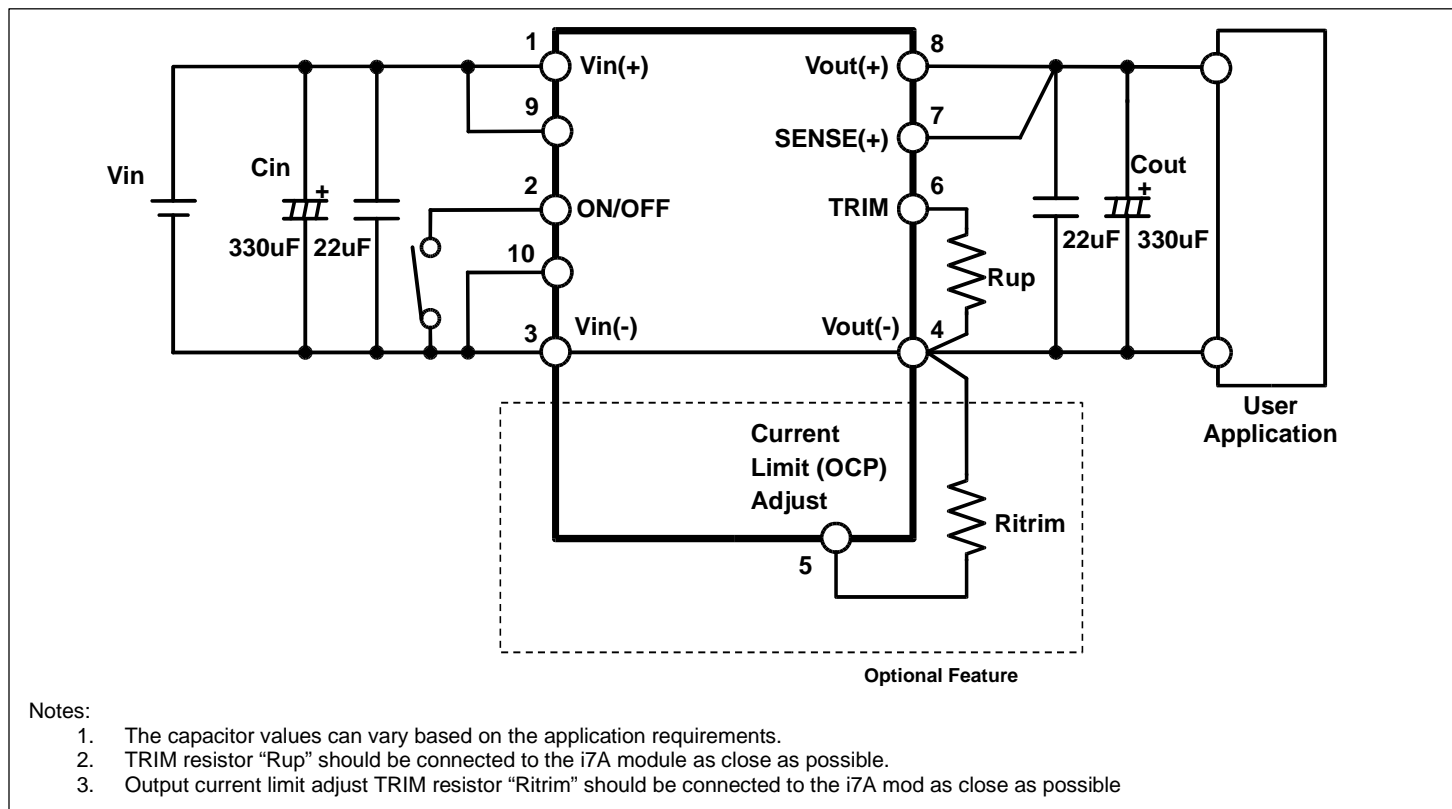

Mechanical Specification: (Open Frame -00x-R product option)

Dimensions are in mm [in]. Unless otherwise specified tolerances are:

$x.x \pm 0.5$ [0.02], $x.xx \pm 0.25$ [0.010]

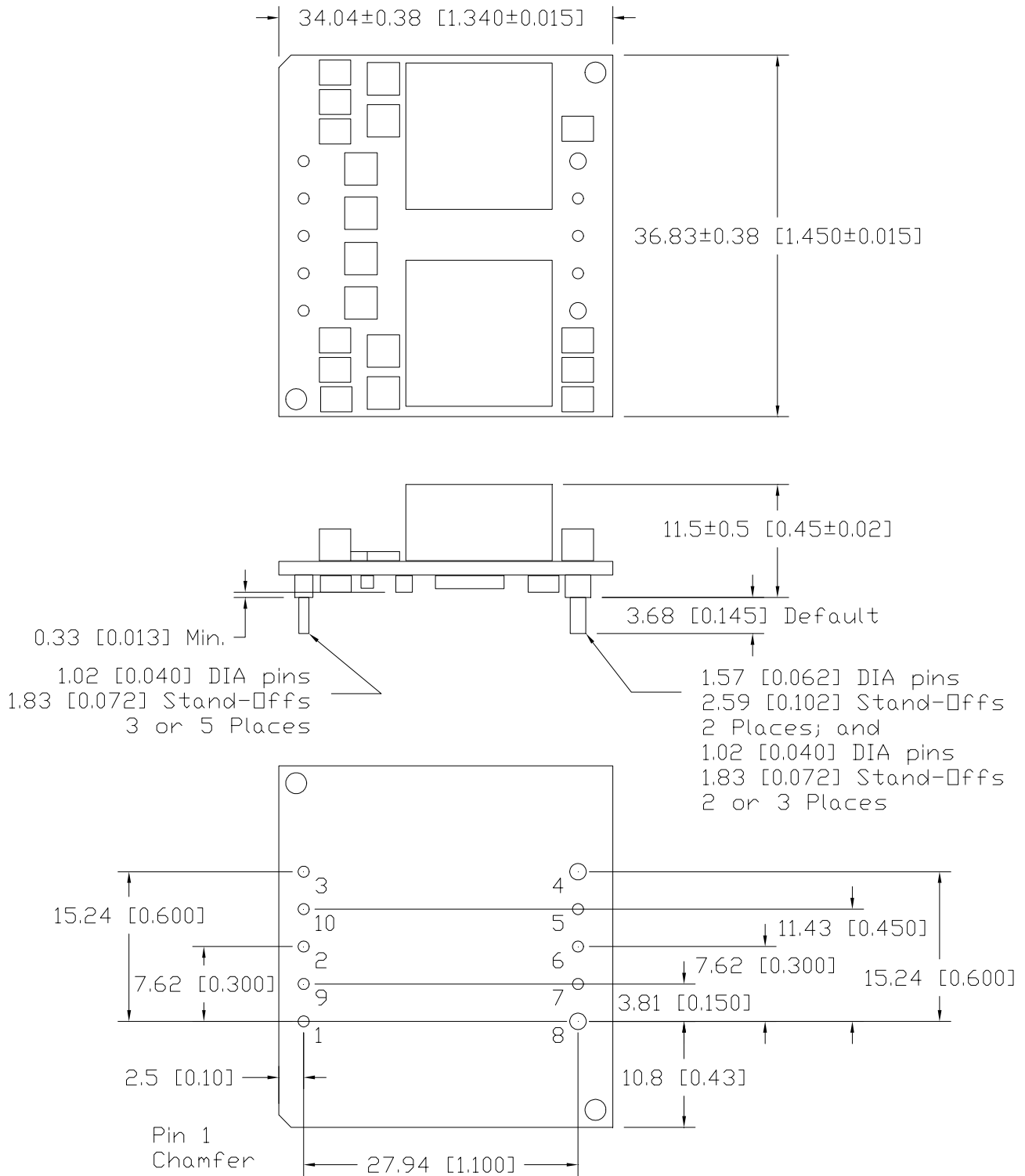

Mechanical Specification: (With Baseplate –xCx-R product option)

Dimensions are in mm [in]. Unless otherwise specified tolerances are: x.x ± 0.5 [0.02], x.xx ± 0.25 [0.010]

*To avoid damaging components, do not exceed 8.0 [0.32] depth with M3 screws

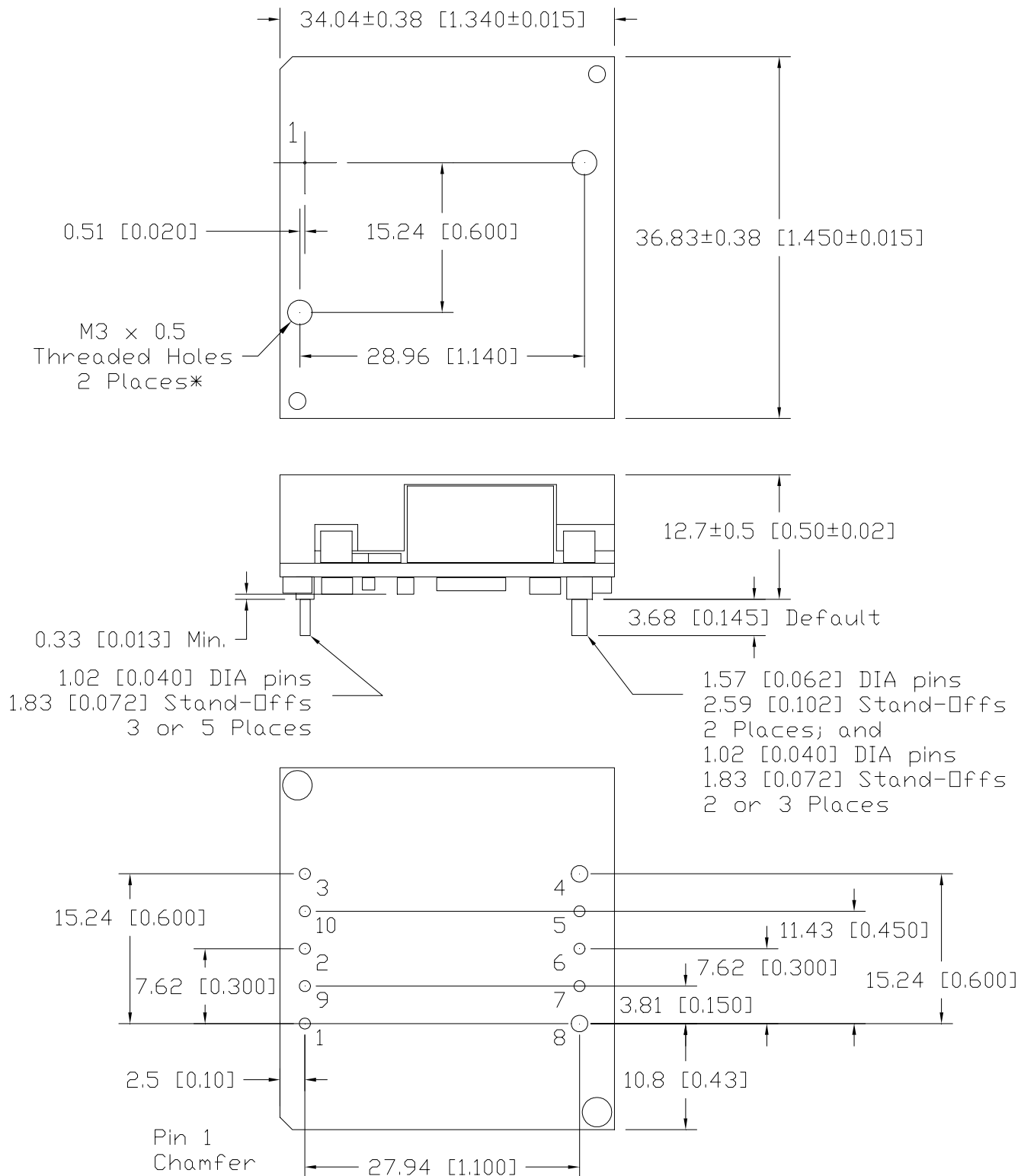

Mechanical Specification: (With Heatsink –xFx-R product option)

Dimensions are in mm [in]. Unless otherwise specified tolerances are: $x.x \pm 0.5$ [0.02], $x.xx \pm 0.25$ [0.010]

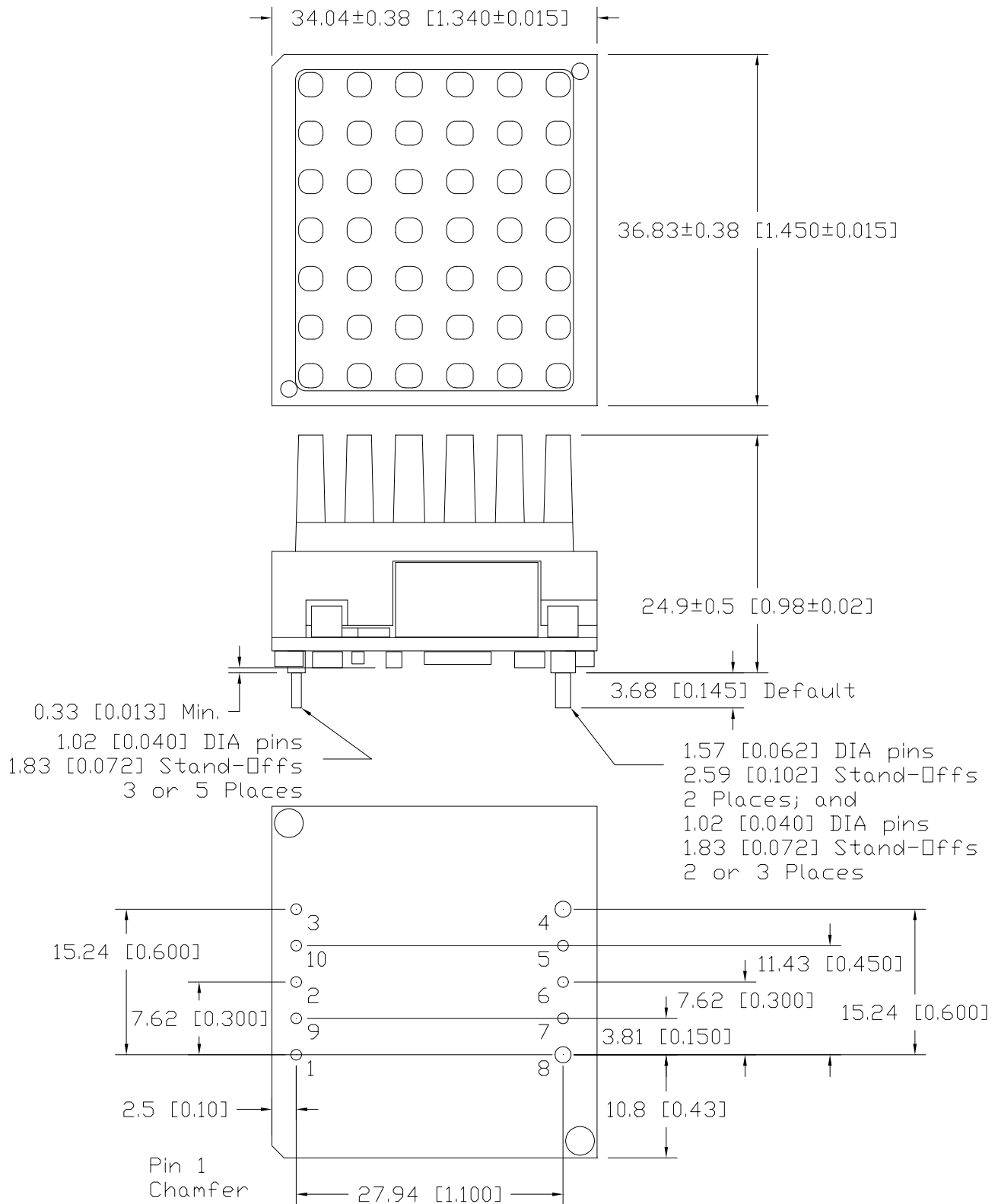

Recommended Hole Pattern – i7A4W033A033V-xxx-R (Top View):

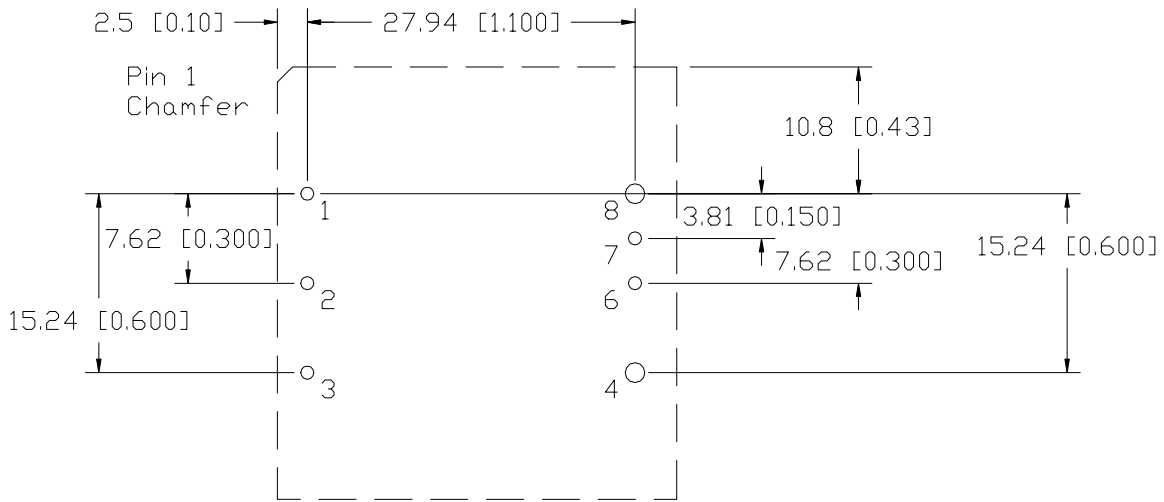

Recommended Hole Pattern – i7A24045A033V-xxx-R (Top View): Pins 9 & 10 Added

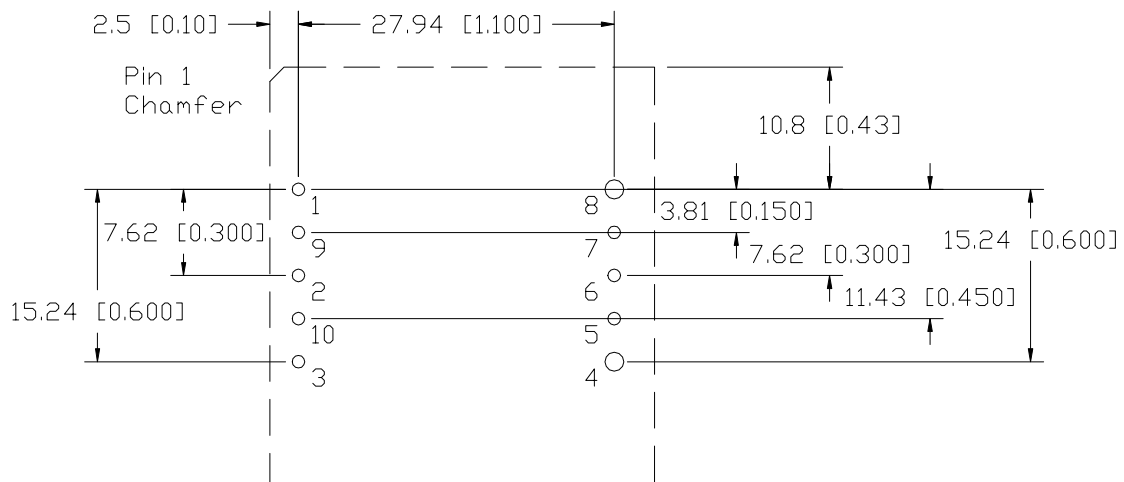

Pin Assignment:

PIN	FUNCTION	PIN	FUNCTION
1	Vin (+)	6	TRIM
2	On/Off	7	SENSE +
3	Vin (-) / GND	8	Vout (+)
4	Vout (-) / GND	9*	Vin (+)
5	Power Good OR OCP Adjustment**	10*	Vin (-) / GND

Note:

Pin base material is brass or copper with gold over nickel plating.

Maximum Module Weight:

Open Frame : 25g (0.88 oz)

With Baseplate : 50g (1.76 oz)

With Heatsink : 70g (2.47 oz)

*Pin 9 & 10 are added for products drawing higher input currents. Refer to ordering information option table.

** Pin 5 is only populated when one of these features are present. Refer to ordering information option table.

Absolute Maximum Ratings:

Stress in excess of Absolute Maximum Ratings may cause permanent damage to the device.

Characteristic	Min	Max	Unit	Notes & Conditions
Transient Input Voltage (t < 100ms)	-0.25	65	V	i7A4W
	-0.25	36	V	i7A24
	-0.25	22	V	i7A12
Isolation Voltage	---	---	Vdc	None
Storage Temperature	-55	125	°C	
Operating Temperature Range (Tc)	-40	125*	°C	Measured at the location specified in the thermal measurement figure; maximum temperature varies with output current – see curve in the thermal performance section of the data sheet.

*Engineering estimate

Input Characteristics:

Unless otherwise specified, specifications apply over all rated Input Voltage, Resistive Load, and Temperature conditions.

Characteristic	Min	Typ	Max	Unit	Notes & Conditions
Operating Input Voltage	18	---	60	Vdc	Vin > Vo (i7A4W)
	18	---	32	Vdc	Vin > Vo (i7A24)
	28	---	60	Vdc	Vin > Vo (i7A48)
	9	---	18	Vdc	Vin > Vo (i7A12)
Maximum Input Current	---	---	50	A	Vin = Vin,min to Vin,max; Io = Io,max; i7A4W and i7A24
	---	---	35	A	i7A48
	---	---	65	A	i7A12
Startup Delay Time from application of input voltage	---	2	---	ms	Vo = 0 to 0.1*Vo,set; on/off=on, Io = Io,max, Tc = 25 °C
Startup Delay Time from On/Off	---	2	---	ms	Vo = 0 to 0.1*Vo,set; Vin = Vi,nom, Io = Io,max, Tc = 25 °C
Output Voltage Rise Time	---	6	---	ms	Io = Io,max, Tc = 25 °C, Vo = 0.1 to 0.9*Vo,set
Input Ripple Rejection	---	50*	---	dB	@ 120 Hz
Turn on input voltage	---	16.5	---	V	i7A4W and i7A24
	---	24	---	V	i7A48
	---	8.1	---	V	i7A12
Turn off input voltage	---	15	---	V	i7A4W and i7A24
	---	20	---	V	i7A48
	---	7.6	---	V	i7A12

*Engineering estimate

Caution: The power modules are not internally fused. An external input line very fast acting fuse is required; see the Safety Considerations section of the data sheet.

Electrical Data: i7A4W033A033V

Characteristic	Min	Typ	Max	Unit	Notes & Conditions
Output Voltage Initial Setpoint	-2	-	+2	%	$V_o = 12V_{\text{setting}}$, $V_{in} = V_{in,nom}$; $I_o = I_{o,min}$; $T_c = 25\text{ }^\circ\text{C}$
Output Voltage Tolerance	-3.5	-	+3.5	%	Over all rated input voltage, load, and temperature conditions to end of life
Efficiency				%	$V_{in} = 24V$; $I_o = I_{o,max}$; $T_c = 25\text{ }^\circ\text{C}$
	$V_o = 3.3V$	91	---		
	$V_o = 5V$	94	---		
	$V_o = 12V$	97	---		
	$V_o = 18V$	98	---		
Efficiency				%	$V_{in} = 48V$; $I_o = I_{o,max}$; $T_c = 25\text{ }^\circ\text{C}$
	$V_o = 5V$	91	---		
	$V_o = 12V$	95	---		
	$V_o = 18V$	96	---		
	$V_o = 24V$	97	---		
Line Regulation	---	0.2	---	%	$V_{in} = V_{in,min}$ to $V_{in,max}$
Load Regulation	---	0.4	---	%	$I_o = I_{o,min}$ to $I_{o,max}$
Output Current	0	---	33	A	Observe maximum power limit and input voltage derating
Output Current Limiting Threshold	---	45	---	A	$V_o = 0.9 \cdot V_{o,nom}$, $T_c < T_{c,max}$
Short Circuit Current	---	33	---	A	$V_o = 0.25V$, $T_c = 25\text{ }^\circ\text{C}$
Output Ripple and Noise Voltage	---	25	---	mVpp	Measured across one 22 μF ceramic capacitor – see input/output ripple measurement figure; BW = 20MHz.
Output Voltage Adjustment Range	3.3	---	24	V	
Output Voltage Sense Range	---	---	5	%	
Dynamic Response: Recovery Time	---	70	---	μs	$di/dt = 1A/\mu\text{s}$, $V_{in} = V_{in,nom}$; $V_o = 12V$, load step from 25% to 75% of $I_{o,max}$
Transient Voltage	---	420	---	mV	
Switching Frequency	---	330	---	kHz	Fixed
External Load Capacitance	220	---	10000*	μF	
$V_{o,nom}$	---	3.28	---	V	Required for trim calculation
F	---	16400	---	Ω	Required for trim calculation
G	---	750	---	Ω	Required for trim calculation

*Please contact TDK-Lambda for technical support for very low ESR capacitor banks or if higher capacitance is required.

Electrical Characteristics: i7A4W033A033V

Typical Efficiency vs. Input Voltage

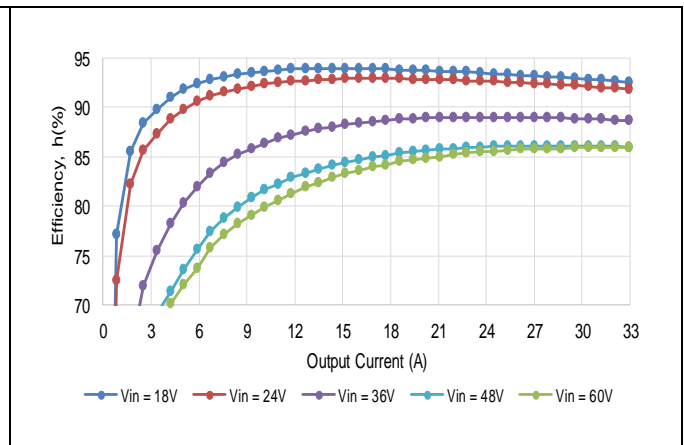
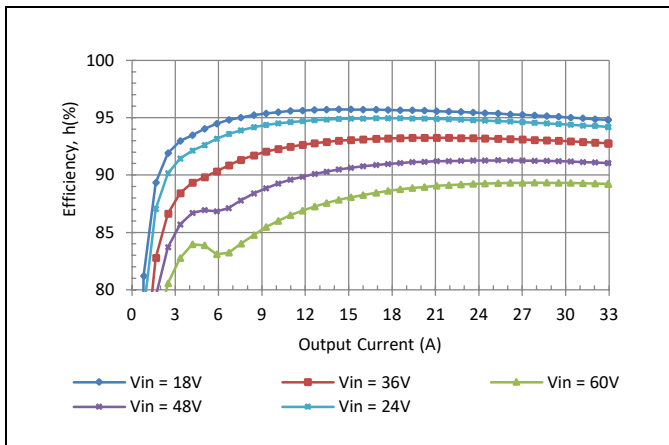
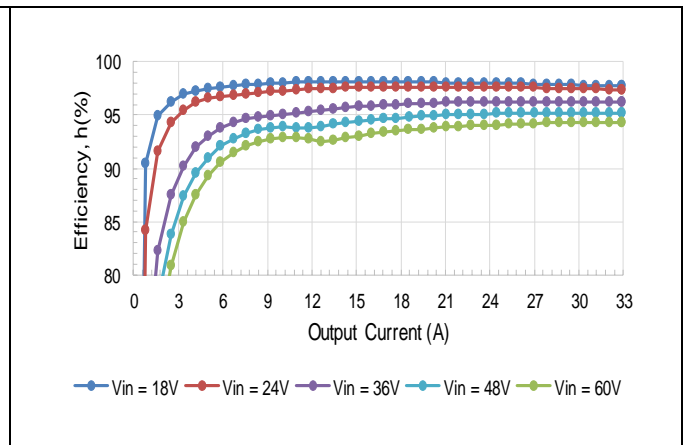
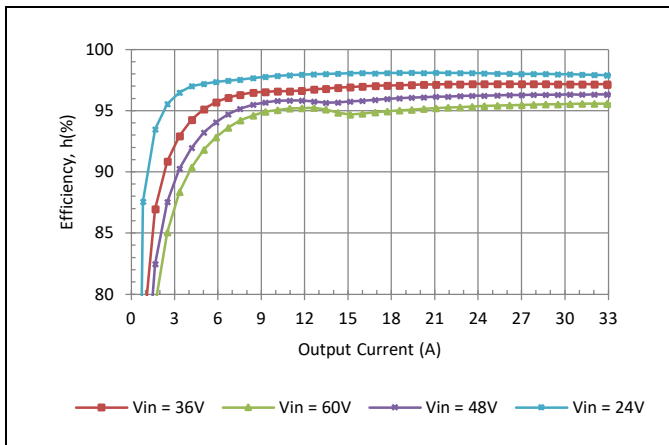
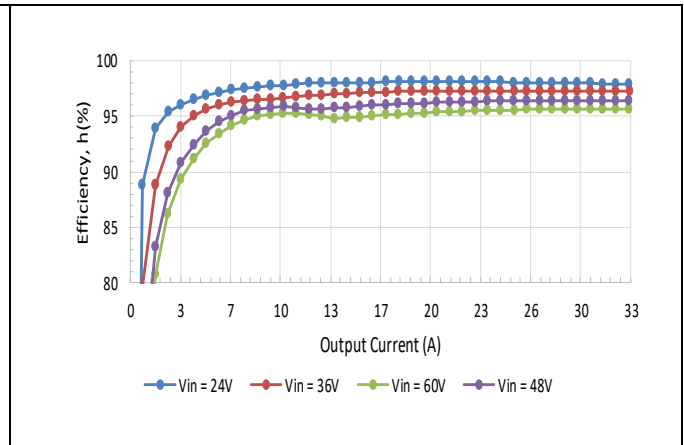
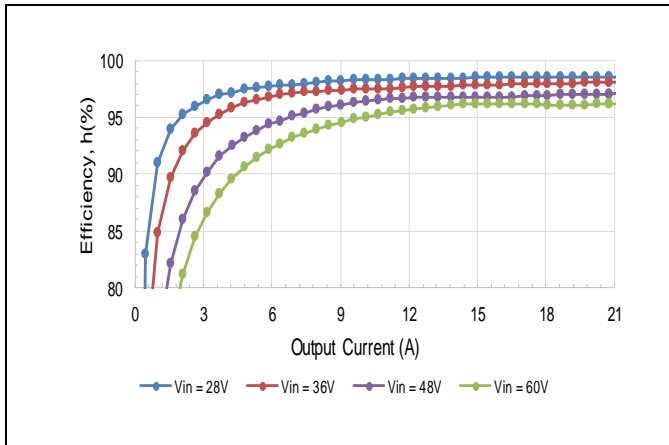

Electrical Characteristics: i7A4W033A033V

Typical Power Dissipation vs. Input Voltage

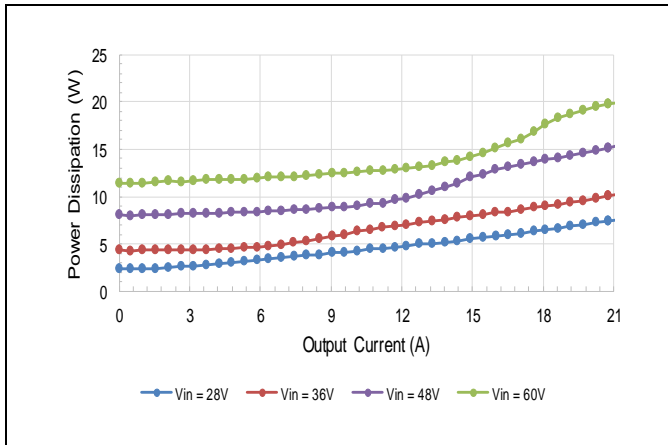

$V_o = 24V$

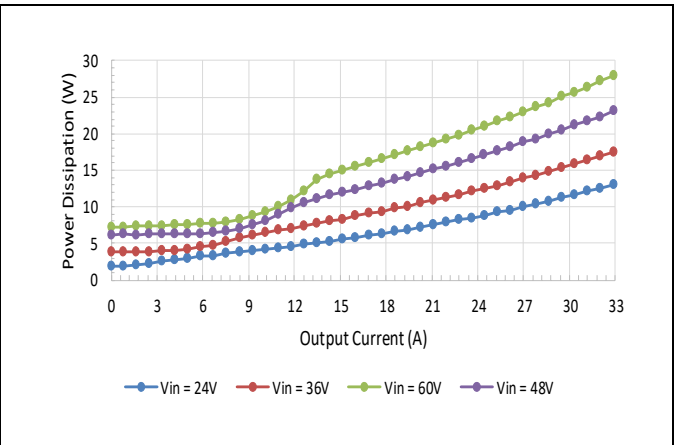

$V_o = 18V$

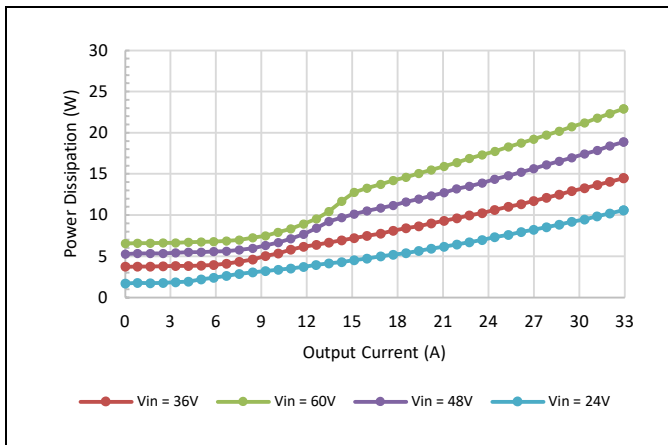

$V_o = 15V$

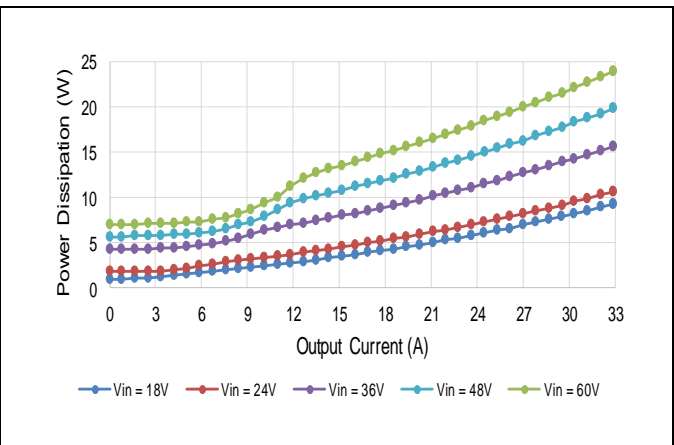

$V_o = 12V$

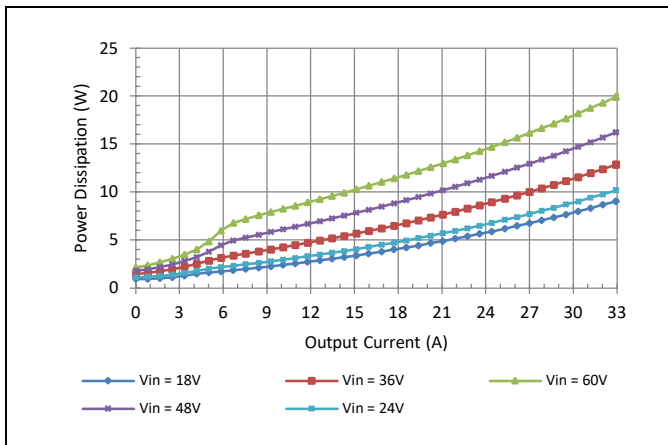

$V_o = 5V$

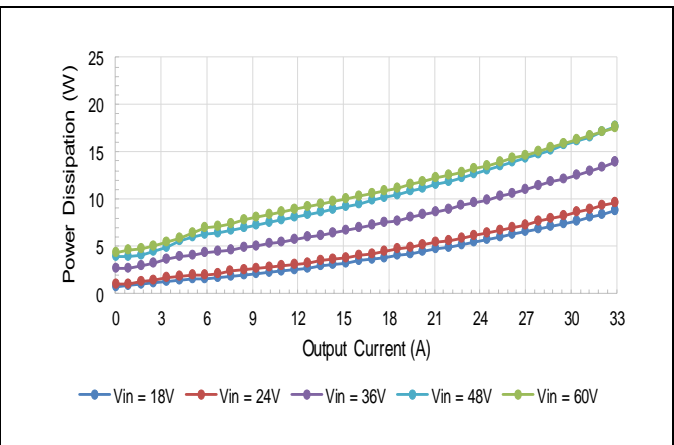

$V_o = 3.3V$

Electrical Characteristics: i7A4W033A033V

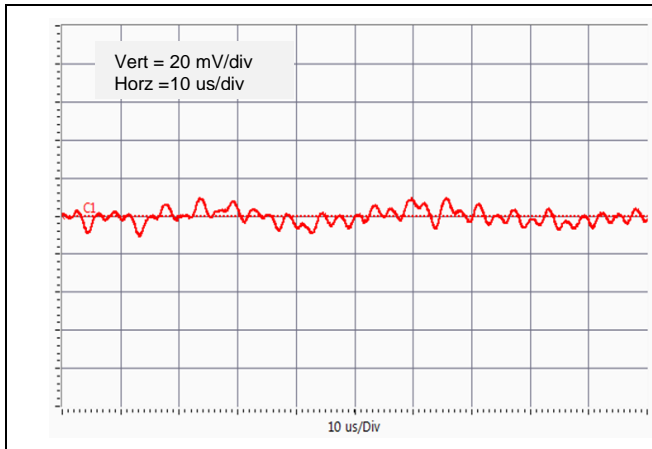

$V_o = 12V$ Typical Output Ripple at nominal Input voltage and full load at $T_a = 25^\circ C$.

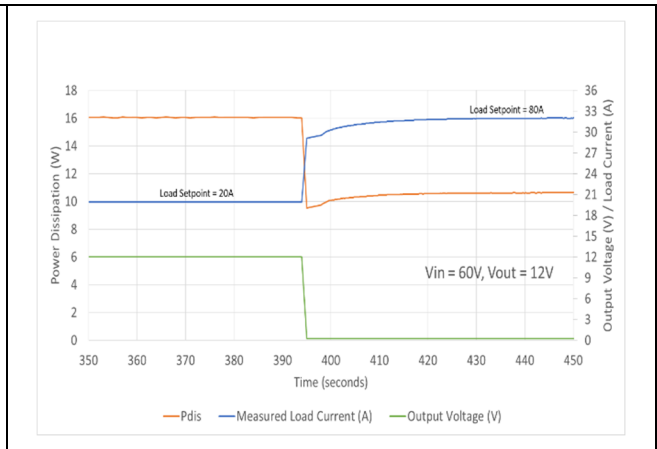

$V_{in} = 60V$ Typical overload characteristics.

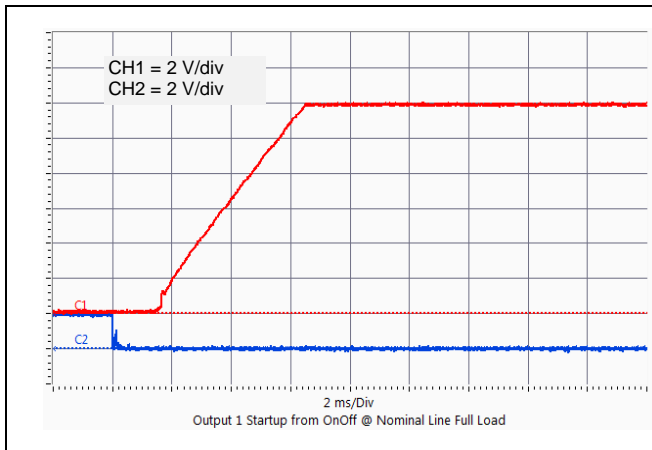

$V_o = 12V$ Typical startup characteristic from On/Off at full load. CH1: Output Voltage, CH2: On/Off Signal.

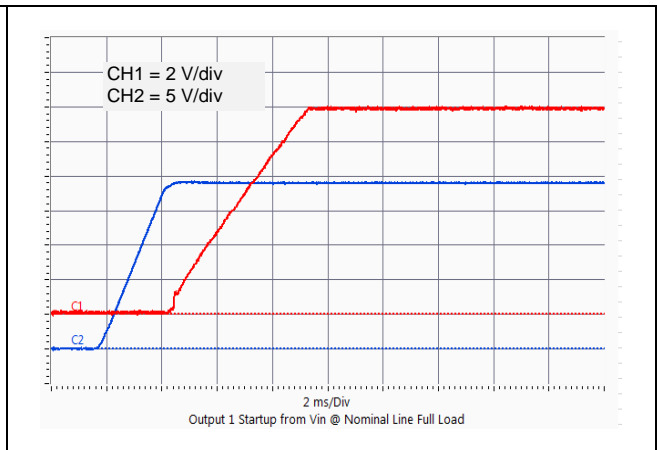

$V_o = 12V$ Typical startup characteristic from input voltage at full load. CH1: Output Voltage, CH2: Input Voltage.

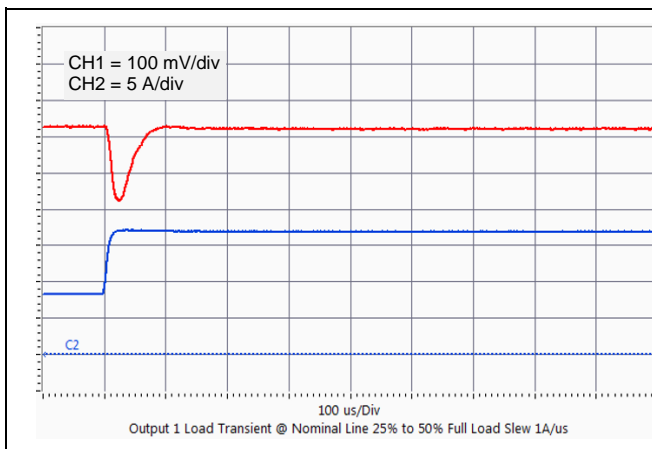

$V_o = 12V$ Typical output voltage transient response to load step from 25% to 50% of full load with output current slew rate of $1A/\mu s$, $C_{ext} = 240 \mu F$.

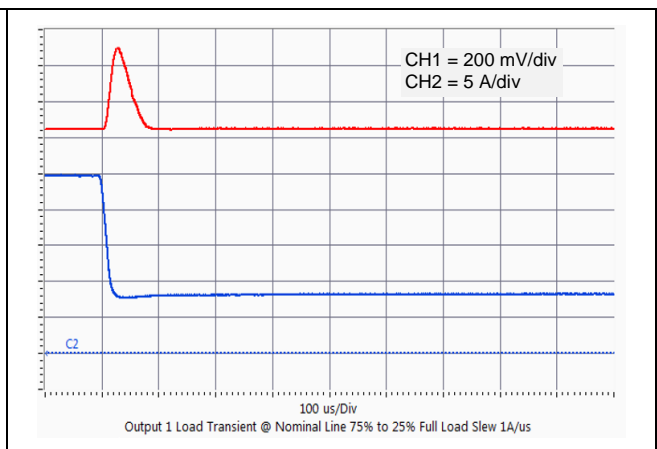

$V_o = 12V$ Typical output voltage transient response to load step from 75% to 25% of full load with output current slew rate of $1A/\mu s$, $C_{ext} = 240 \mu F$ capacitor.

Electrical Characteristics: i7A4W033A033V

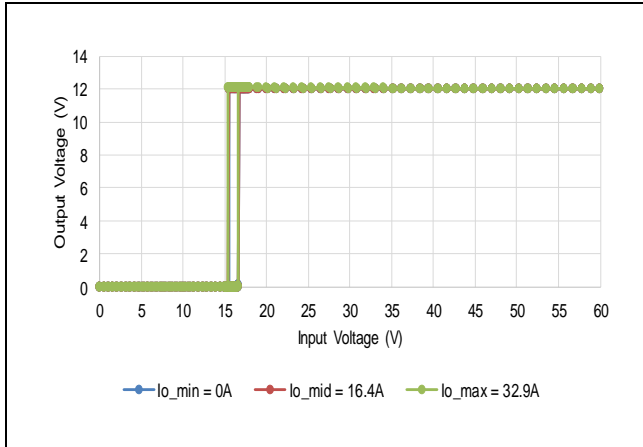

$V_o = 12V$ Typical Output Voltage vs. Input Voltage Characteristics.

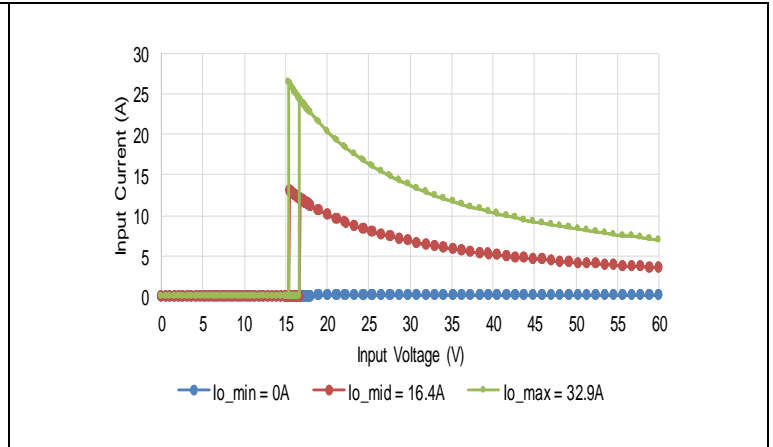

$V_o = 12V$ Typical Input Current vs. Input Voltage Characteristics.

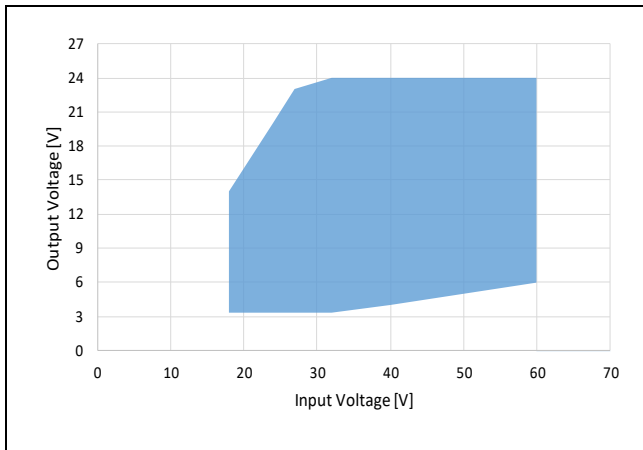

Output Voltage vs. Input Voltage Specified Operating Range.

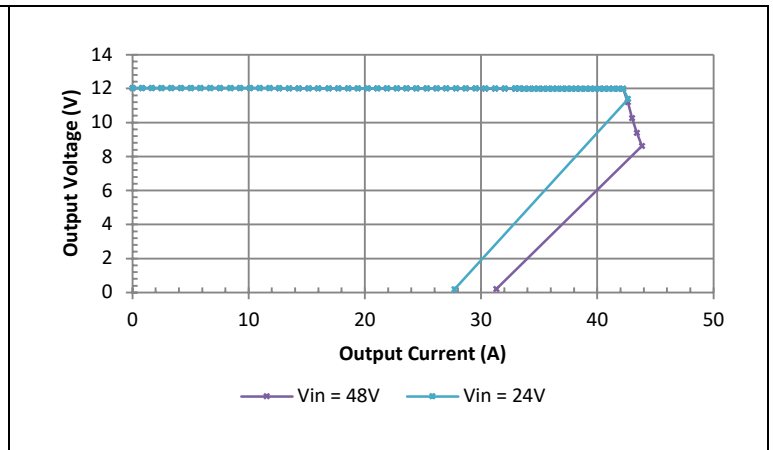

$V_o = 12V$ Typical Current Limit Characteristics.

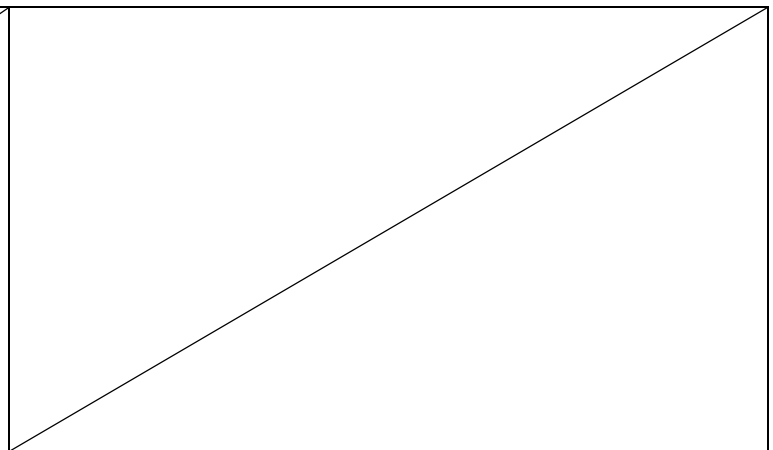
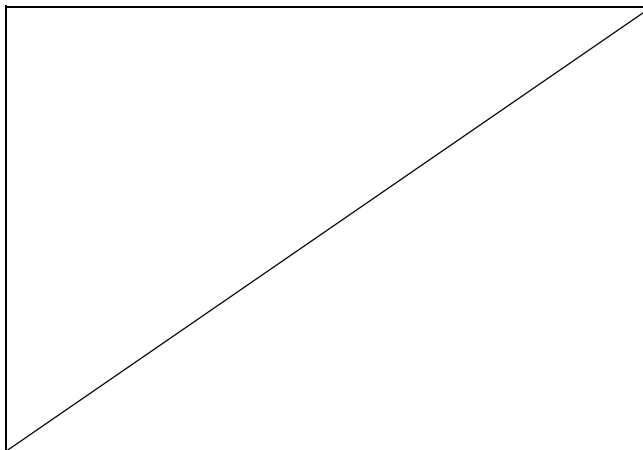

Thermal Performance: i7A4W033A033V (Open frame -00x-R)

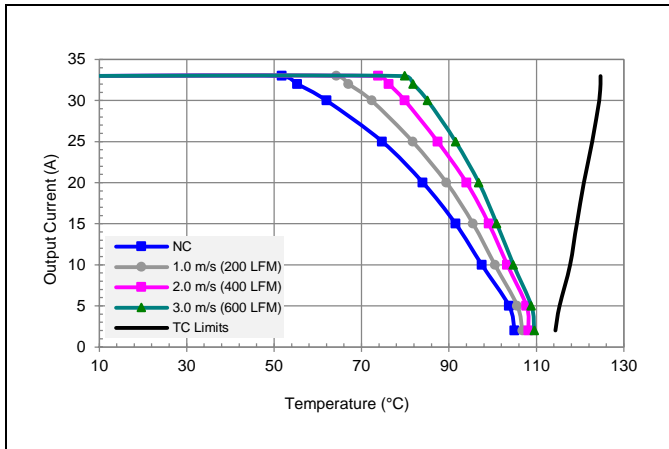

$V_{in} = 24V$, $V_o = 12V$ preliminary maximum output current vs. ambient temperature for natural convection NC (60lfm) to 3m/s (600 lfm) with airflow from pin 3 to pin 4.

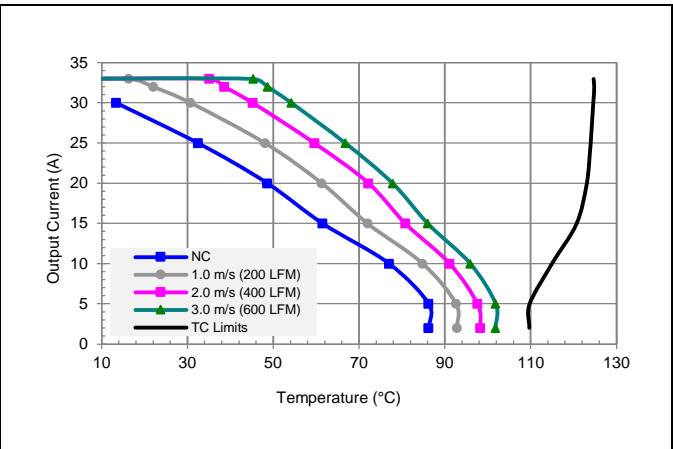

$V_{in} = 48V$, $V_o = 12V$ preliminary maximum output current vs. ambient temperature for natural convection NC (60lfm) to 3m/s (600 lfm) with airflow from pin 3 to pin 4.

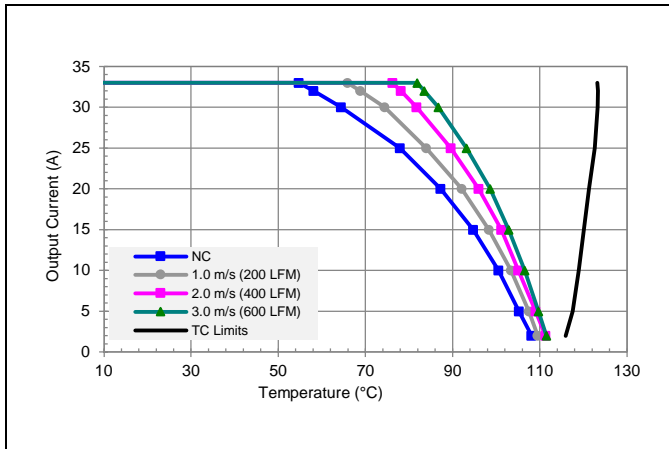

$V_{in} = 24V$, $V_o = 5V$ preliminary maximum output current vs. ambient temperature for natural convection NC (60lfm) to 3m/s (600 lfm) with airflow from pin 3 to pin 4.

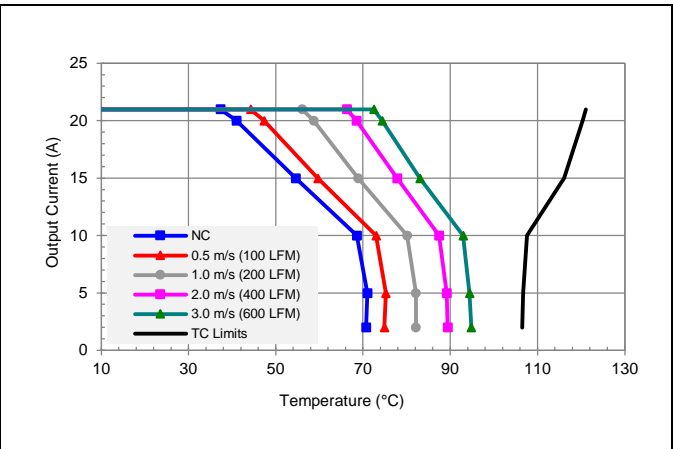

$V_{in} = 48V$, $V_o = 24V$ preliminary maximum output current vs. ambient temperature for natural convection NC (60lfm) to 3m/s (600 lfm) with airflow from pin 3 to pin 4.

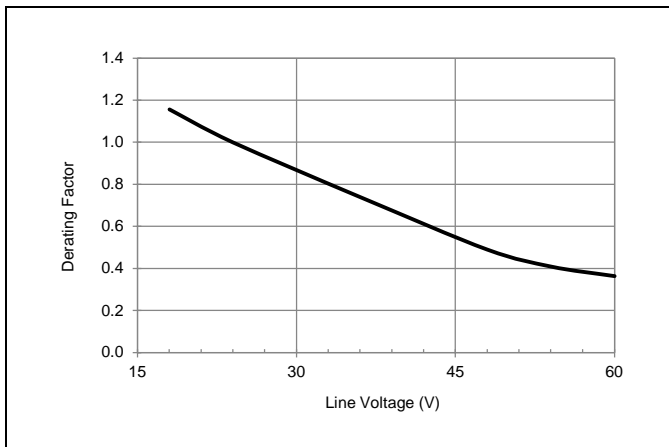

Typical output current derating versus line voltage with airflow 1m/s (200 lfm) and $T_a = 65^\circ C$.

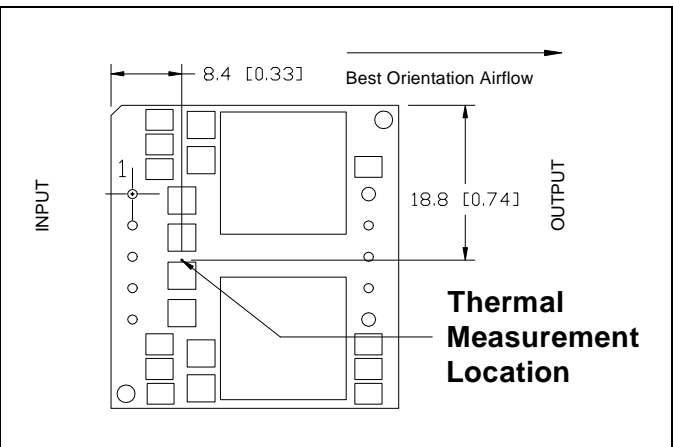

i7A4W033A033V thermal measurement location – top view.

Thermal Performance: i7A4W033A033V (with Baseplate -xCx-R)

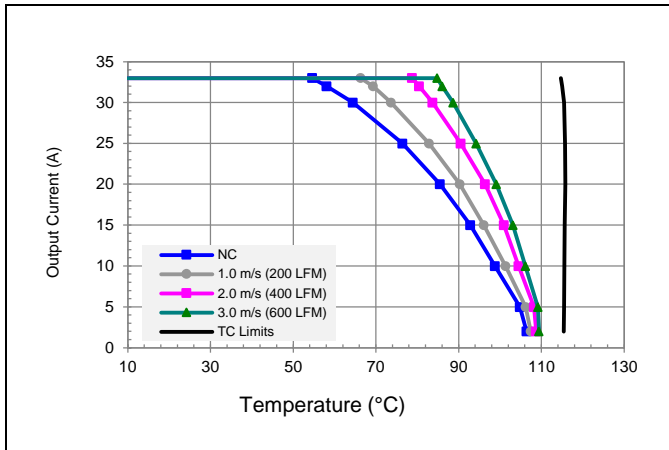

Vin = 24V, Vo = 12V preliminary maximum output current vs. ambient temperature for natural convection NC (60lfm) to 3m/s (600 lfm) with airflow from pin 3 to pin 4.

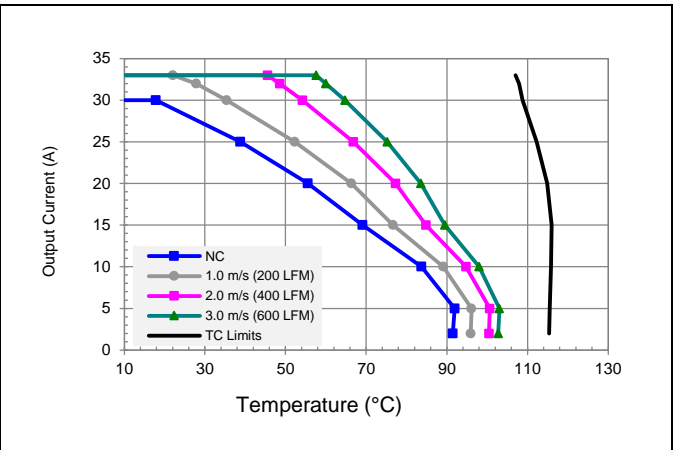

Vin = 48V, Vo = 12V preliminary maximum output current vs. ambient temperature for natural convection NC (60lfm) to 3m/s (600 lfm) with airflow from pin 3 to pin 4.

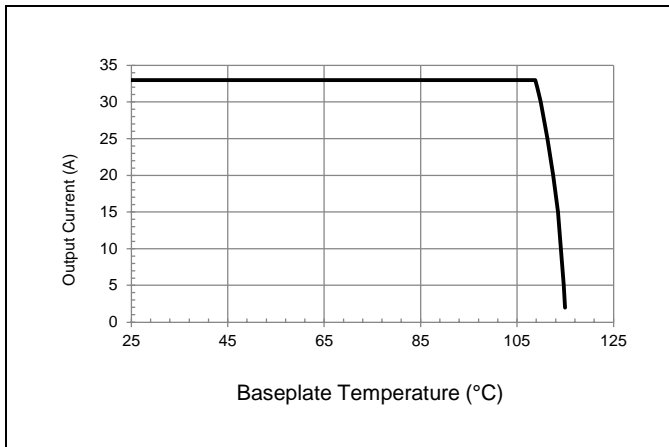

Typical baseplate temperature versus output current derating curve for conduction cooling application with Vo = 12V

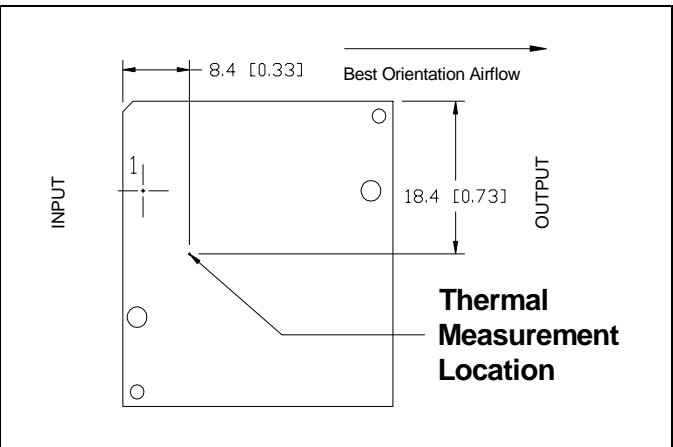

i7A4W033A033V-xCx-R thermal measurement location – top view.

Thermal Performance: i7A4W033A033V (with Heatsink – xFx-R)

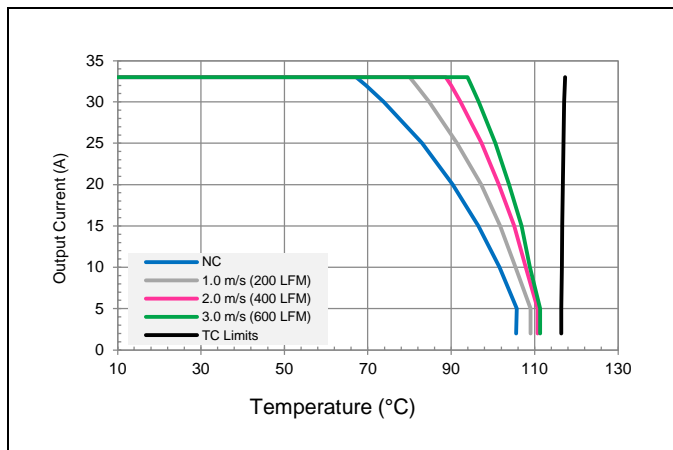

$V_{in} = 24V$, $V_o = 12V$ preliminary maximum output current vs. ambient temperature for natural convection NC (60lfm) to 3m/s (600 lfm) with airflow from pin 3 to pin 4.

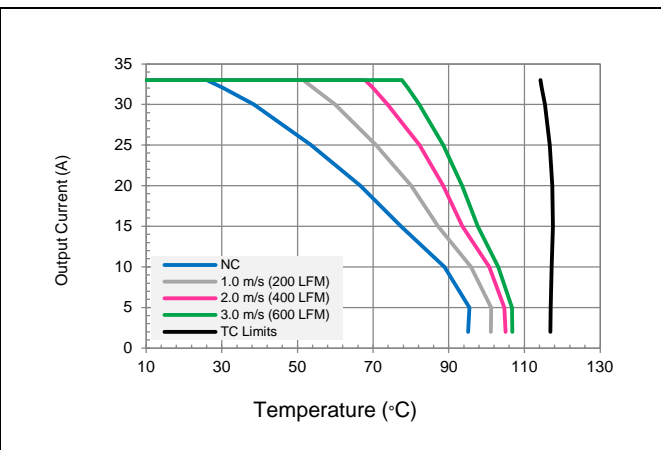

$V_{in} = 48V$, $V_o = 12V$ preliminary maximum output current vs. ambient temperature for natural convection NC (60lfm) to 3m/s (600 lfm) with airflow from pin 3 to pin 4.

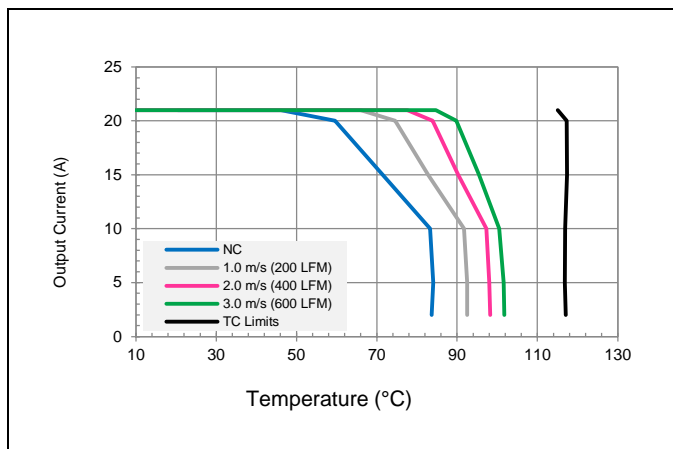

$V_{in} = 48V$, $V_o = 24V$ preliminary maximum output current vs. ambient temperature for natural convection NC (60lfm) to 3m/s (600 lfm) with airflow from pin 3 to pin 4.

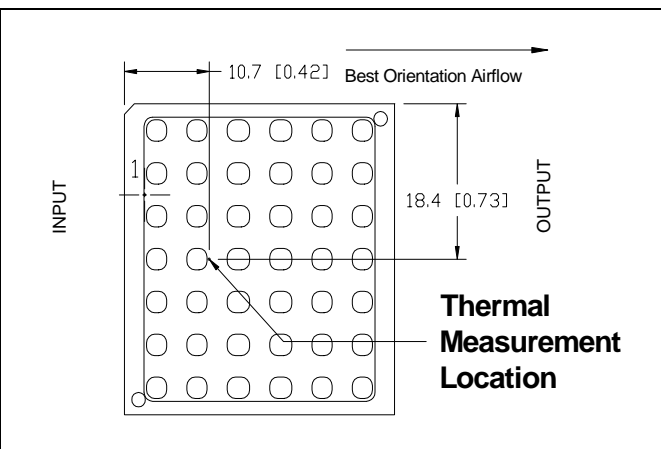

i7A4W033A033V-xFx-R thermal measurement location – top view.

The thermal curves provided are based upon measurements made in TDK-Lambda's experimental test setup that is described in the Thermal Management section. Due to the large number of variables in system design, TDK-Lambda recommends that the user verify the module's thermal performance in the end application. The critical component should be thermocoupled and monitored, and should not exceed the temperature limit specified in the derating curve above. Due to the extremely wide range of operating points, it is important to verify thermal performance in the end application. The temperature can change significantly with operating input voltage. It is critical that the thermocouple be mounted in a manner that gives direct thermal contact or significant measurement errors may result. TDK-Lambda can provide modules with a thermocouple pre-mounted to the critical component for system verification tests.

Electrical Data: i7A24045A033V

Characteristic	Min	Typ	Max	Unit	Notes & Conditions
Output Voltage Initial Setpoint	-2	-	+2	%	$V_o = 12V_{\text{setting}}$, $V_{in} = V_{in,nom}$; $I_o = I_{o,min}$; $T_c = 25^\circ\text{C}$
Output Voltage Tolerance	-3.5	-	+3.5	%	Over all rated input voltage, load, and temperature conditions to end of life
Efficiency				%	$V_{in} = 24V$; $I_o = I_{o,max}$; $T_c = 25^\circ\text{C}$
		93			$V_o = 3.3V$
		95			$V_o = 5V$
		97.5			$V_o = 12V$
		98.5			$V_o = 18V$
Line Regulation	---	0.2	---	%	$V_{in} = V_{in,min}$ to $V_{in,max}$
Load Regulation	---	0.4	---	%	$I_o = I_{o,min}$ to $I_{o,max}$
Output Current	0	---	45	A	Observe maximum power limit and input voltage derating
Output Current Limiting Threshold	---	63	---	A	$V_o = 0.9 \cdot V_{o,nom}$, $T_c < T_{c,max}$
Short Circuit Current	---	50	---	A	$V_o = 0.25V$, $T_c = 25^\circ\text{C}$
Output Ripple and Noise Voltage	---	25	---	mVpp	Measured across one 22 μF ceramic capacitor – see input/output ripple measurement figure; BW = 20MHz.
Output Voltage Adjustment Range	3.3	---	18	V	
Output Voltage Sense Range	---	---	5	%	
Dynamic Response: Recovery Time	---	80	---	μs	$di/dt = 1A/\mu\text{s}$, $V_{in} = V_{in,nom}$; $V_o = 12V$, load step from 25% to 50% of $I_{o,max}$
Transient Voltage	---	425	---	mV	
Switching Frequency	---	330	---	kHz	Fixed
External Load Capacitance	330	---	10000*	μF	
V _{onom}	---	3.28	---	V	Required for trim calculation
F	---	16400	---	Ω	Required for trim calculation
G	---	825	---	Ω	Required for trim calculation

*Please contact TDK-Lambda for technical support for very low ESR capacitor banks or if higher capacitance is required.

Electrical Characteristics: i7A24045A033V

Typical Efficiency vs. Input Voltage

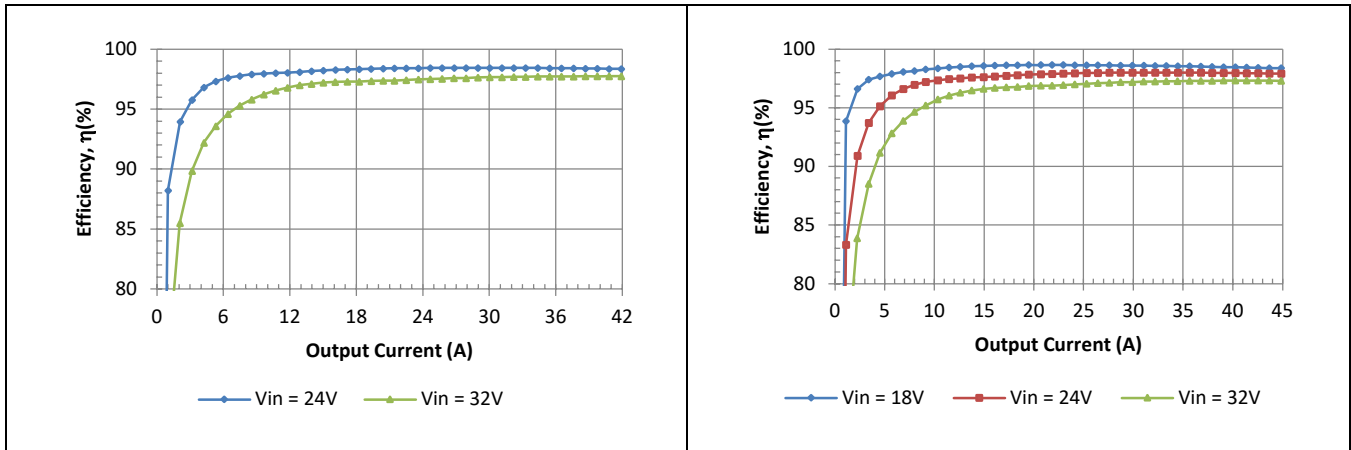

Vo = 18V

Vo = 15V

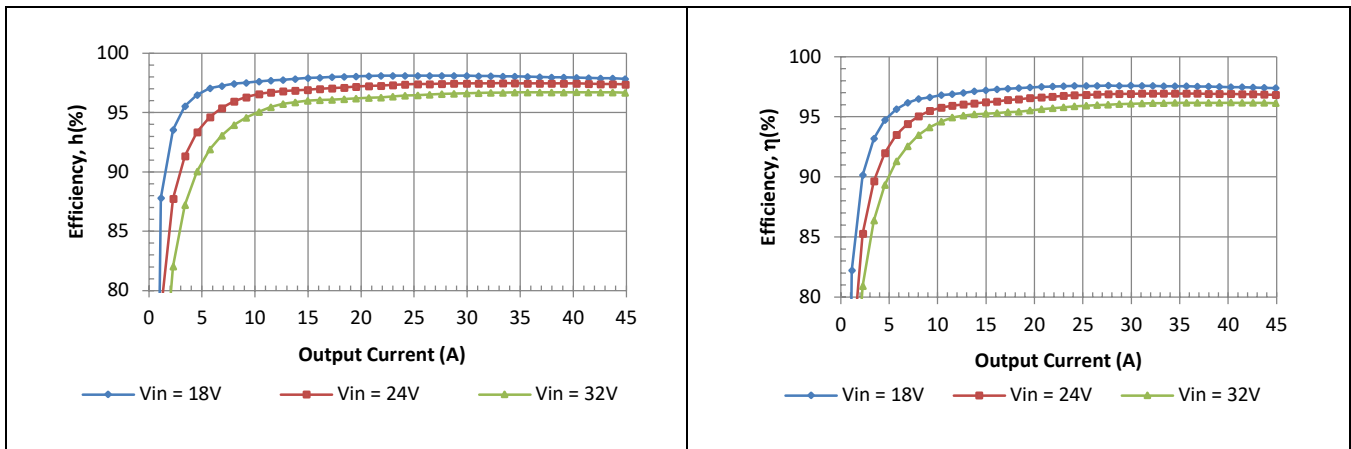

Vo = 12V

Vo = 9.6V

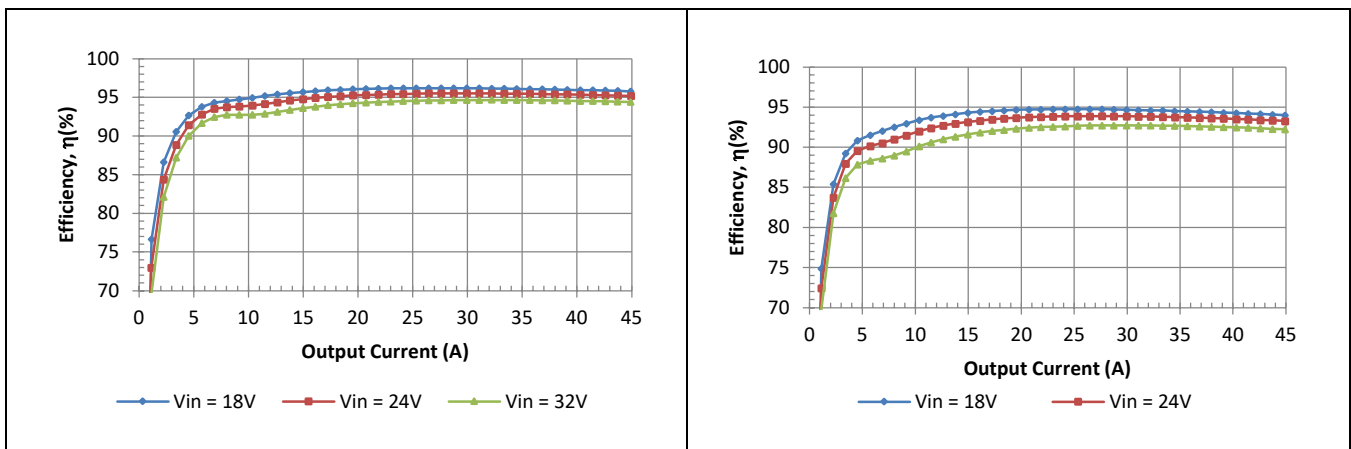

Vo = 5V

Vo = 3.3V

Electrical Characteristics: i7A24045A033V

Typical Power Dissipation vs. Input Voltage

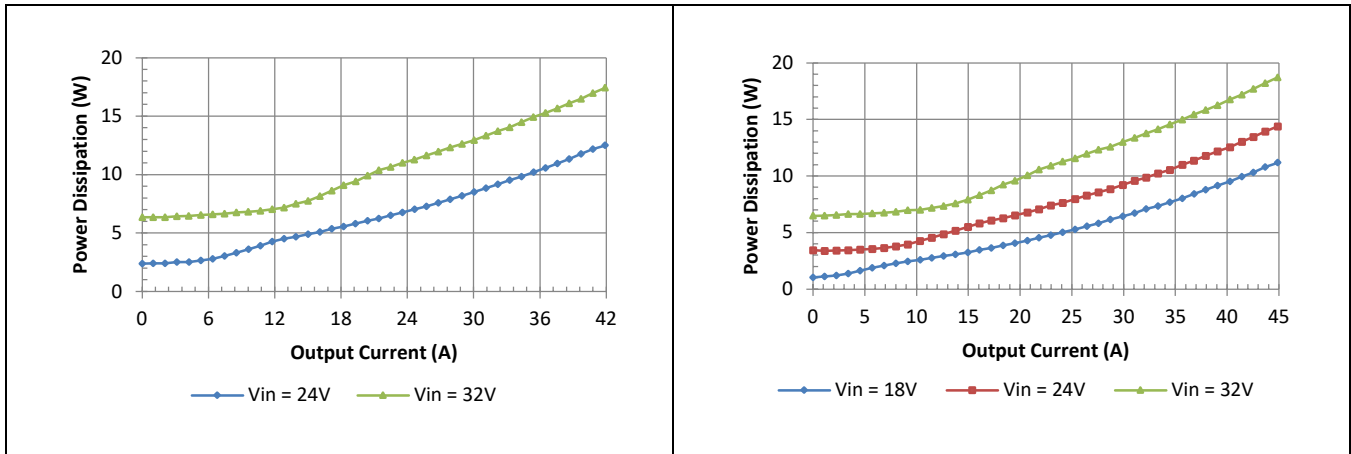

$V_o = 18V$

$V_o = 15V$

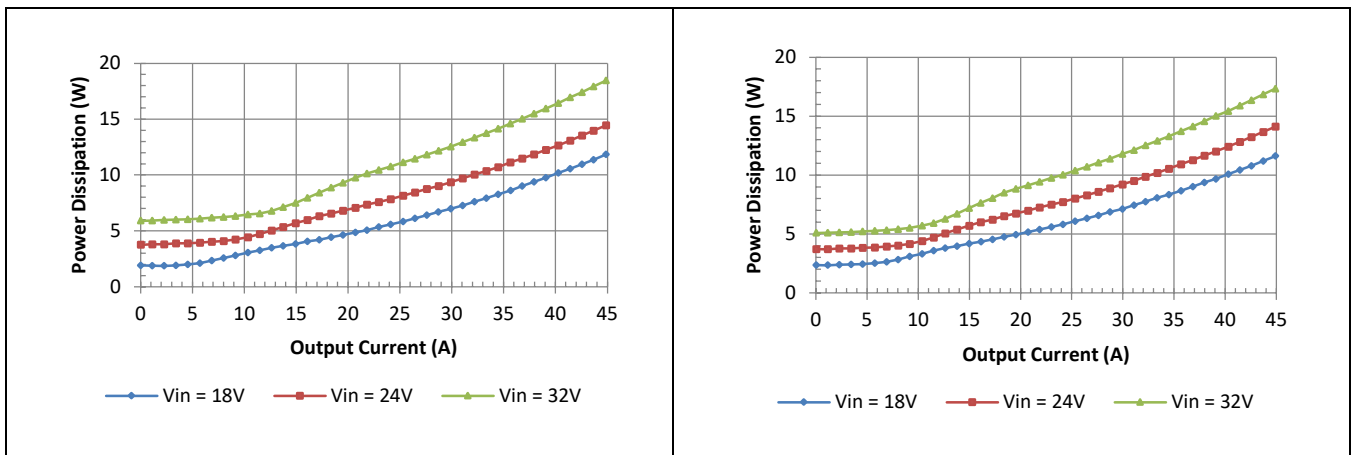

$V_o = 12V$

$V_o = 9.6V$

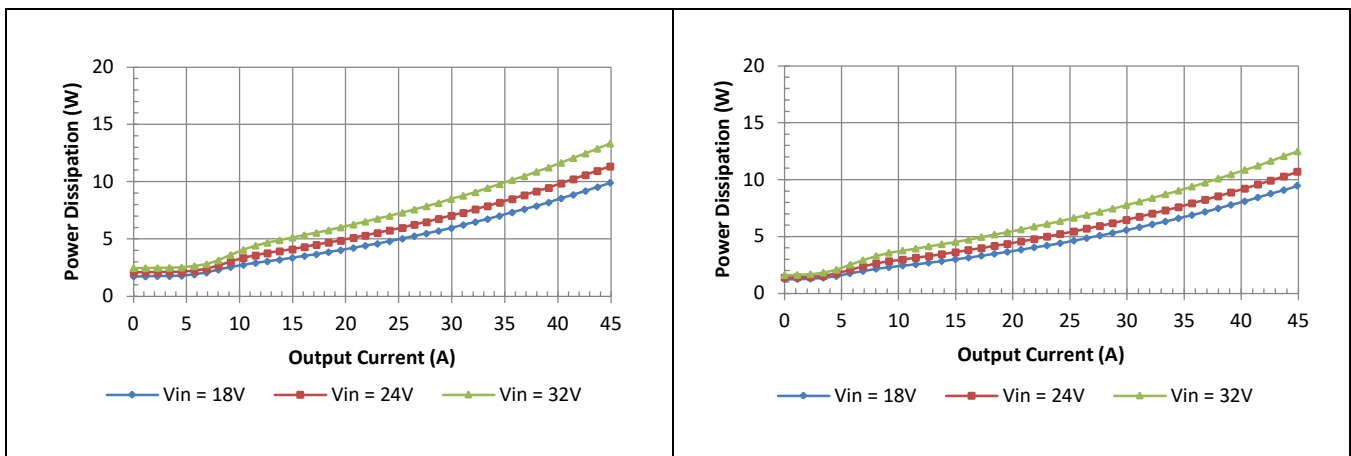

$V_o = 5V$

$V_o = 3.3V$

Electrical Characteristics: i7A24045A033V

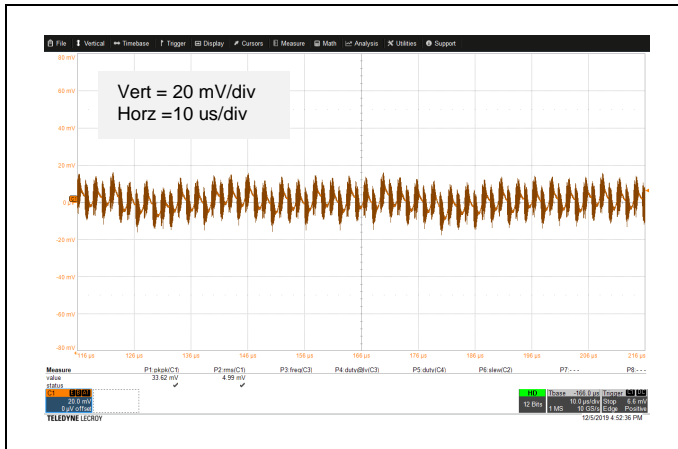

$V_o = 12V$ Typical Output Ripple at nominal Input voltage and full load at $T_a = 25^\circ C$.

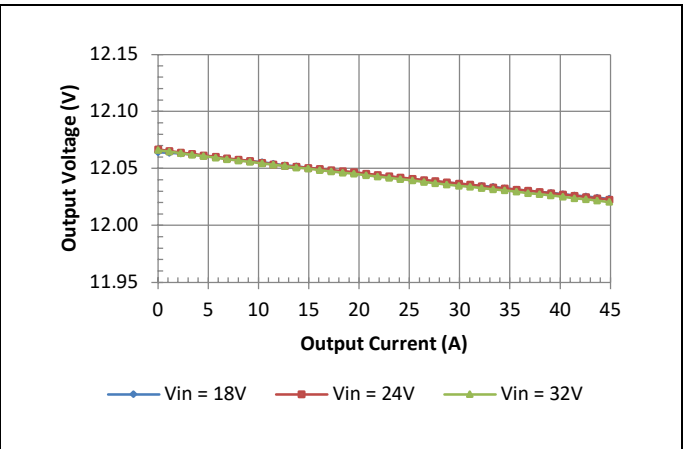

$V_o = 12V$ Typical Load regulation.

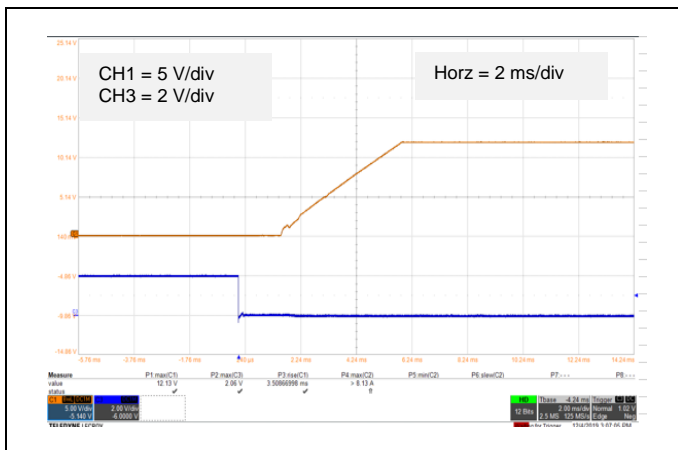

$V_o = 12V$ Typical startup characteristic from On/Off at full load. CH1: Output Voltage, CH3: On/Off Signal.

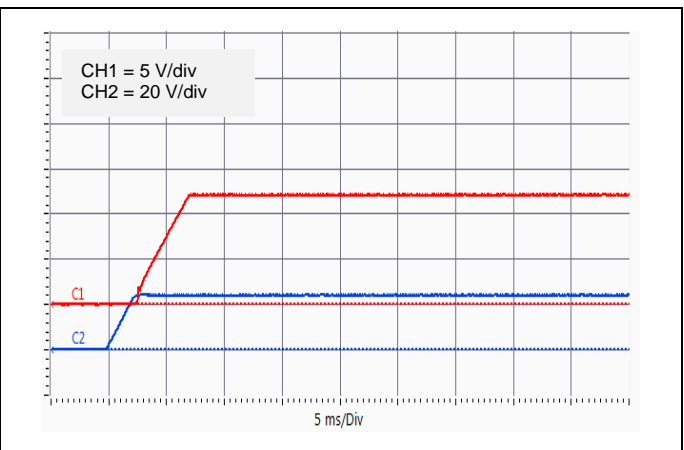

$V_o = 12V$ Typical startup characteristic from input voltage at full load. CH1: Output Voltage, CH2: Input Voltage.

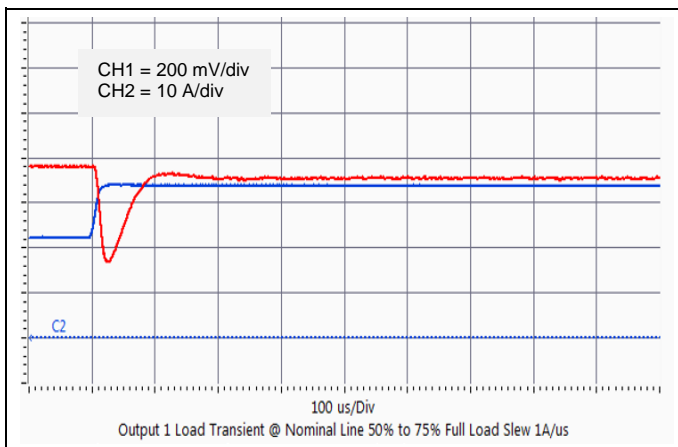

$V_o = 12V$ Typical output voltage transient response to load step from 50% to 75% of full load with output current slew rate of $1A/\mu s$, $C_{ext} = 330 \mu F$.

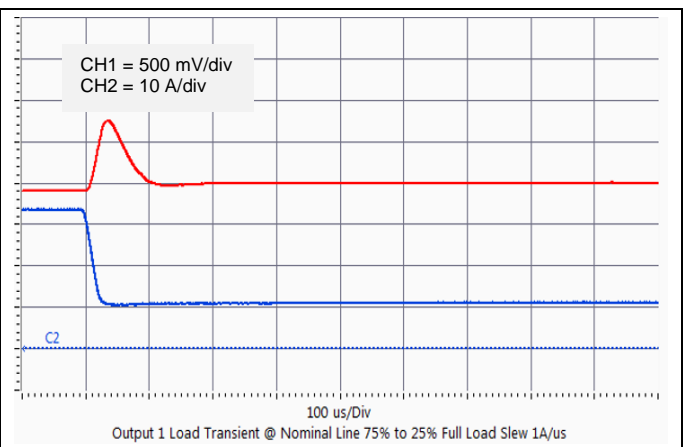

$V_o = 12V$ Typical output voltage transient response to load step from 75% to 25% of full load with output current slew rate of $1A/\mu s$, $C_{ext} = 330 \mu F$ capacitor.

Electrical Characteristics: i7A24045A033V

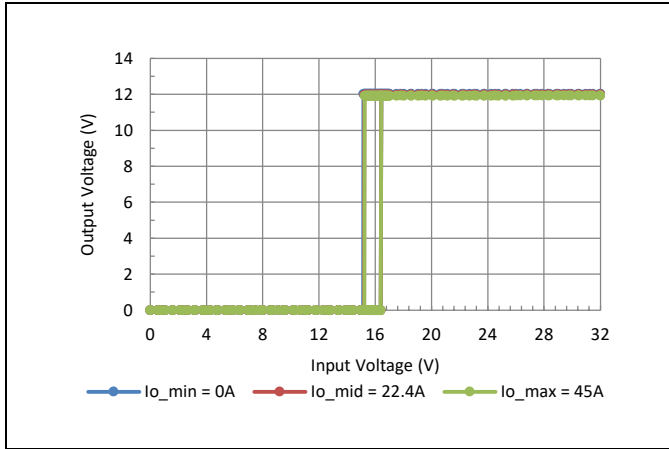

$V_o = 12V$ Typical Output Voltage vs. Input Voltage Characteristics.

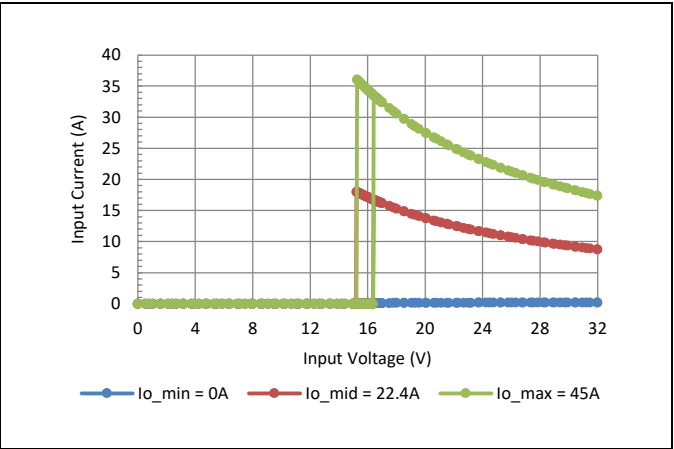

$V_o = 12V$ Typical Input Current vs. Input Voltage Characteristics.

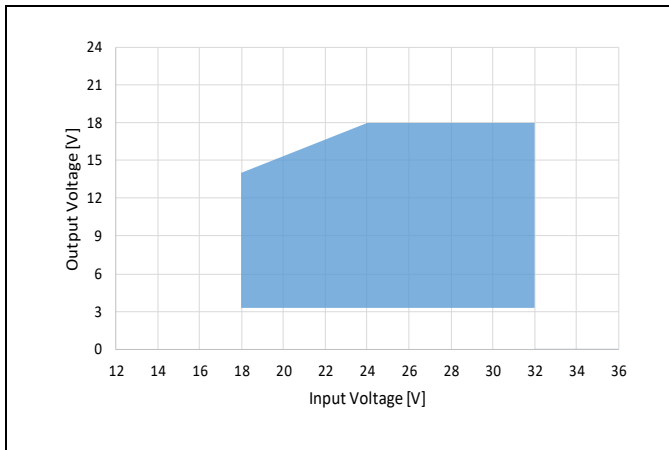

Output Voltage vs. Input Voltage Specified Operating Range.

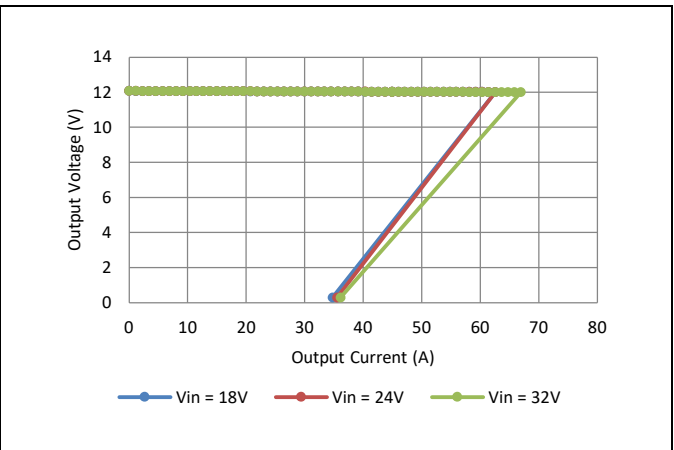

$V_o = 12V$ Typical Current Limit Characteristics.

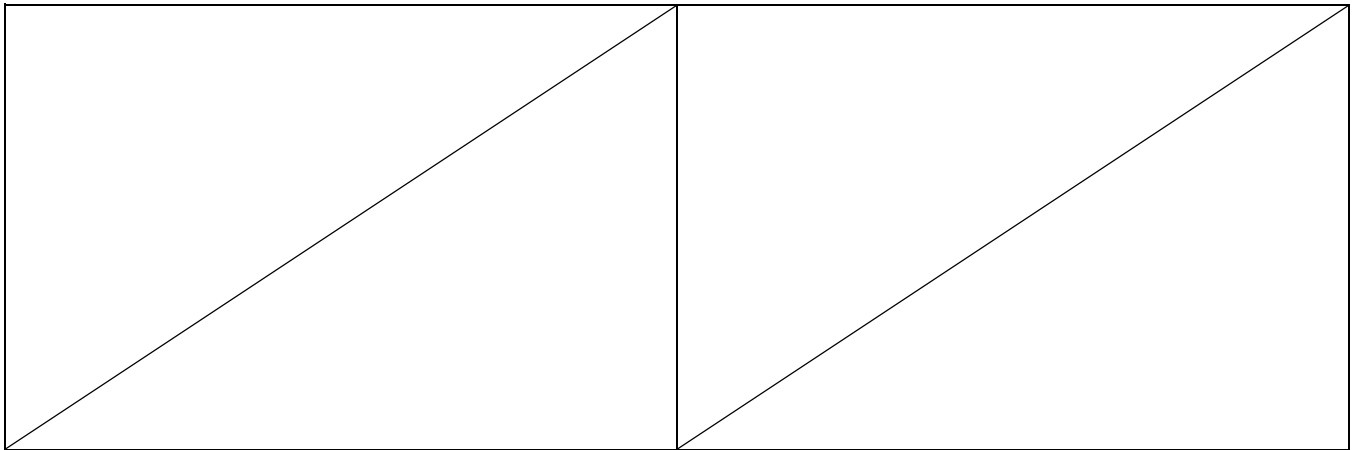

Thermal Performance: i7A24045A033V

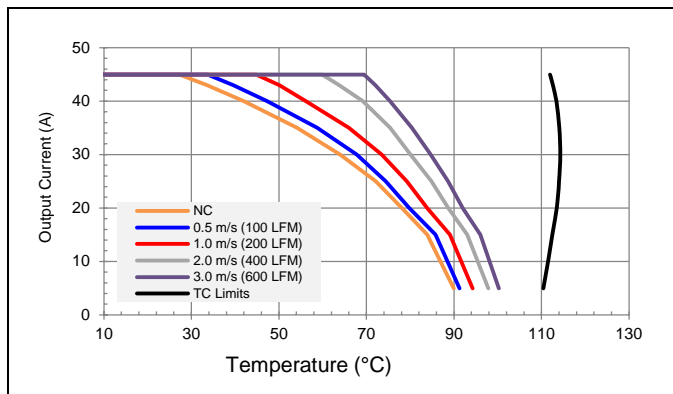

Vin = 24V, Vo = 12V preliminary maximum output current vs. ambient temperature for natural convection NC (60lfm) to 3m/s (600 lfm) with airflow from pin 3 to pin 4.

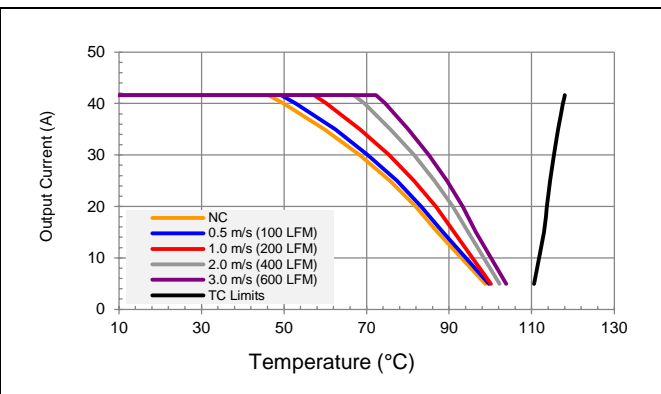

Vin = 24V, Vo = 18V preliminary maximum output current vs. ambient temperature for natural convection NC (60lfm) to 3m/s (600 lfm) with airflow from pin 3 to pin 4.

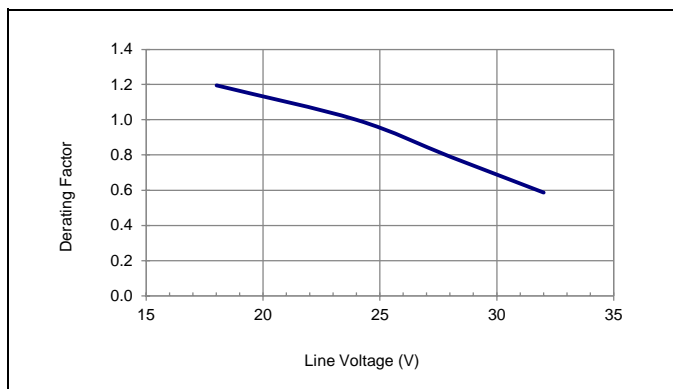

Typical output current derating versus line voltage with airflow 1m/s (200 lfm) and Ta = 65 °C.

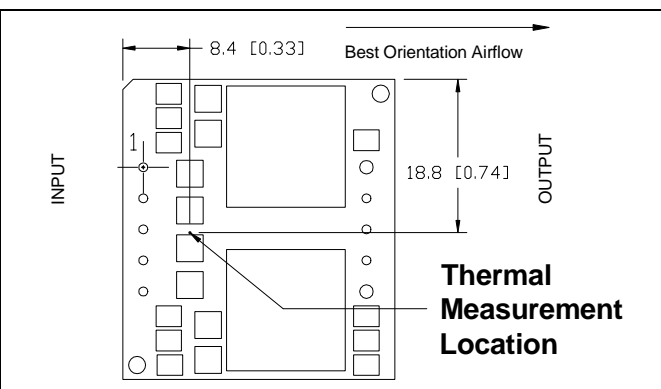

i7A24045A033V thermal measurement location – top view.

The thermal curves provided are based upon measurements made in TDK-Lambda's experimental test setup that is described in the Thermal Management section. Due to the large number of variables in system design, TDK-Lambda recommends that the user verify the module's thermal performance in the end application. The critical component should be thermocoupled and monitored and should not exceed the temperature limit specified in the derating curve above. Due to the extremely wide range of operating points, it is important to verify thermal performance in the end application. The temperature can change significantly with operating input voltage. It is critical that the thermocouple be mounted in a manner that gives direct thermal contact or significant measurement errors may result. TDK-Lambda can provide modules with a thermocouple pre-mounted to the critical component for system verification tests.

Thermal Performance: i7A24045A033V (with baseplate -0C1)

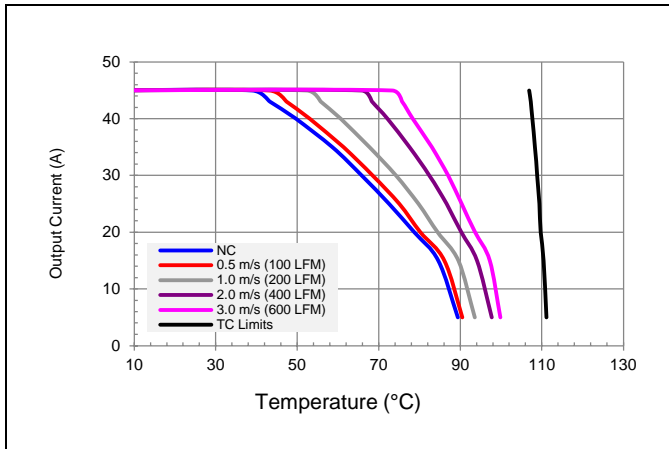

$V_{in} = 24V$, $V_o = 12V$ preliminary maximum output current vs. ambient temperature for natural convection NC (60lfm) to 3m/s (600 lfm) with airflow from pin 3 to pin 4.

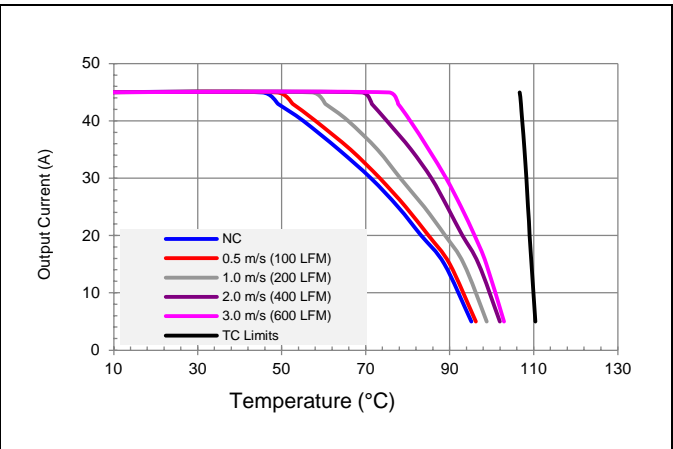

$V_{in} = 24V$, $V_o = 5V$ preliminary maximum output current vs. ambient temperature for natural convection NC (60lfm) to 3m/s (600 lfm) with airflow from pin 3 to pin 4.

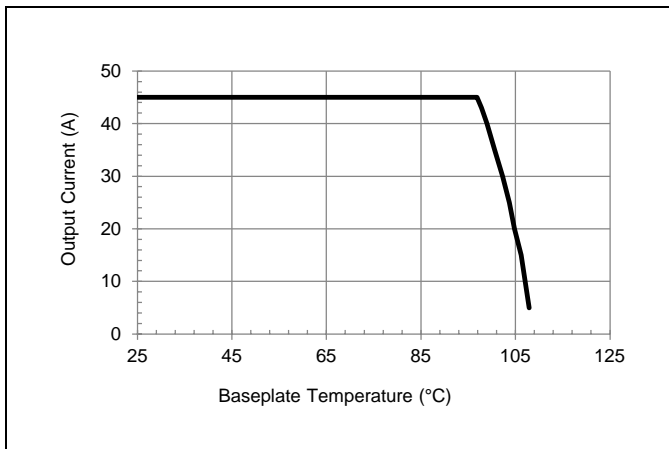

Typical Baseplate temperature versus output current derating curve for conduction cooling application with $V_o = 12V$.

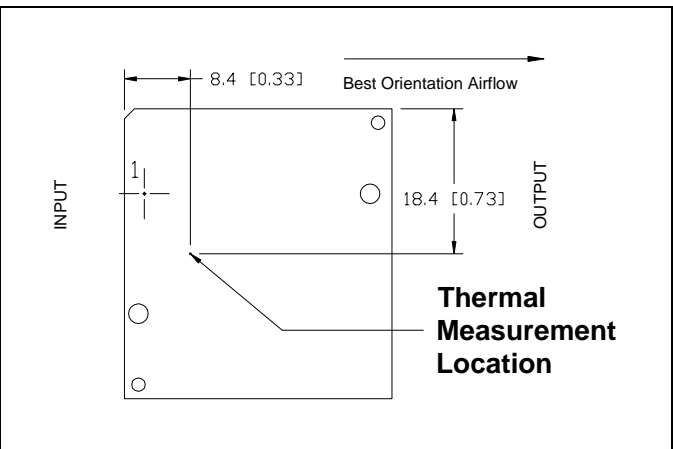

i7A24045A033V-xCx-R thermal measurement location – top view.

Thermal Performance: i7A24045A033V (with heatsink – 0F1)

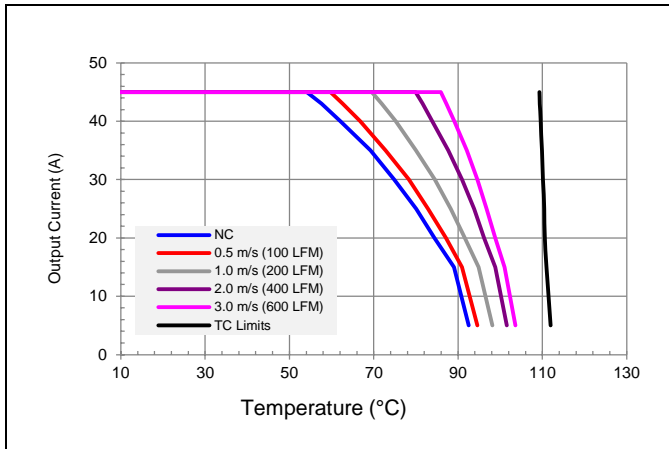

$V_{in} = 24V$, $V_o = 15V$ preliminary maximum output current vs. ambient temperature for natural convection NC (60lfm) to 3m/s (600 lfm) with airflow from pin 3 to pin 4.

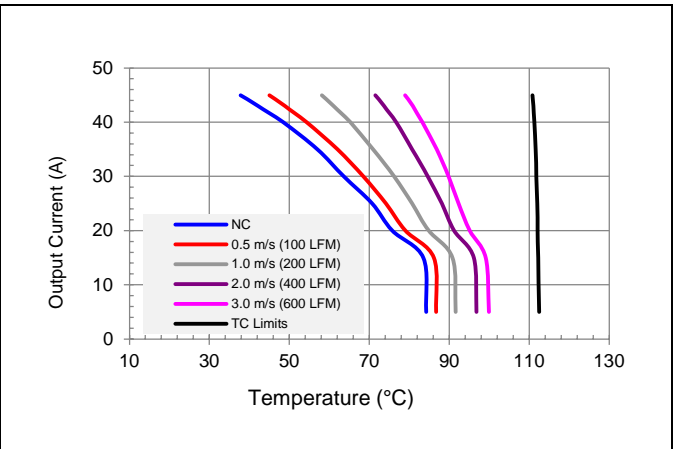

$V_{in} = 32V$, $V_o = 15V$ preliminary maximum output current vs. ambient temperature for natural convection NC (60lfm) to 3m/s (600 lfm) with airflow from pin 3 to pin 4.

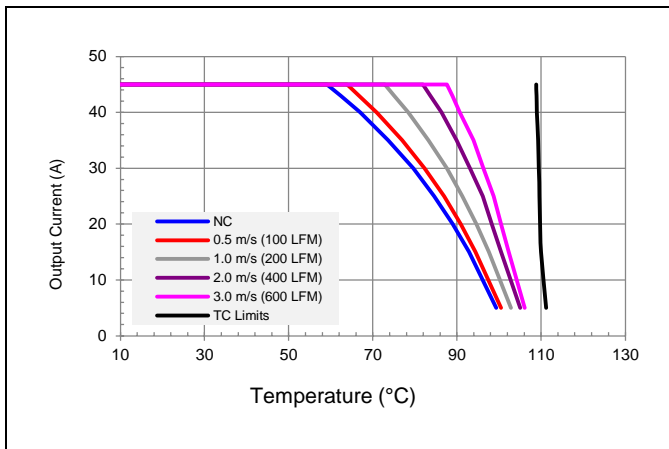

$V_{in} = 24V$, $V_o = 5V$ preliminary maximum output current vs. ambient temperature for natural convection NC (60lfm) to 3m/s (600 lfm) with airflow from pin 3 to pin 4.

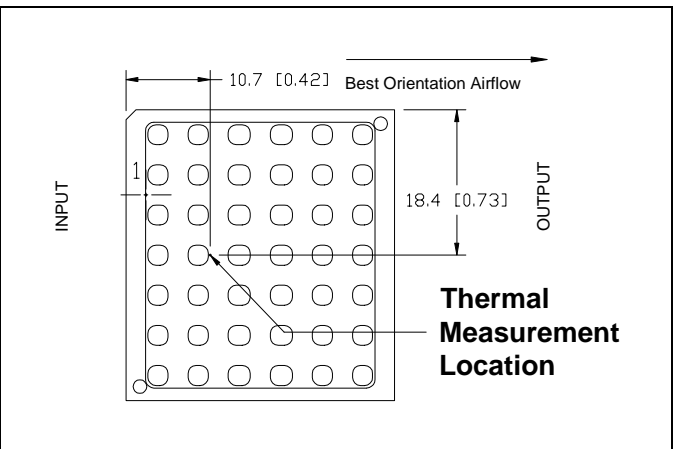

i7A24045A033V-xFx-R thermal measurement location – top view.

Electrical Data: i7A12060A008V

Characteristic	Min	Typ	Max	Unit	Notes & Conditions
Output Voltage Initial Setpoint	-2	-	+2	%	$V_o = 5V_{\text{setting}}$, $V_{in} = V_{in,nom}$; $I_o = I_{o,min}$; $T_c = 25\text{ }^\circ\text{C}$
Output Voltage Tolerance	-3.5	-	+3.5	%	Over all rated input voltage, load, and temperature conditions to end of life
Efficiency				%	$V_{in} = 12V$; $I_o = I_{o,max}$; $T_c = 25\text{ }^\circ\text{C}$
		97			$V_o = 8V$
		95.5			$V_o = 5V$
		93.5			$V_o = 3.3V$
		86			$V_o = 1.2V$
Line Regulation	---	0.2	---	%	$V_{in} = V_{in,min}$ to $V_{in,max}$
Load Regulation	---	0.4	---	%	$I_o = I_{o,min}$ to $I_{o,max}$
Output Current	0	---	60	A	Observe maximum power limit and input voltage derating
Output Current Limiting Threshold	---	70	---	A	$V_o = 0.9 \cdot V_{o,nom}$, $T_c < T_{c,max}$
Short Circuit Current	---	45	---	A	$V_o = 0.25V$, $T_c = 25\text{ }^\circ\text{C}$
Output Ripple and Noise Voltage	---	40	---	mVpp	Measured across one 22 μF ceramic capacitor – see input/output ripple measurement figure; BW = 20MHz.
Output Voltage Adjustment Range	0.8	---	8	V	
Output Voltage Sense Range	---	---	5	%	
Dynamic Response: Recovery Time	---	100	---	μs	$di/dt = 1A/\mu\text{s}$, $V_{in} = V_{in,nom}$; $V_o = 3.3V$, load step from 25% to 50% of $I_{o,max}$
Transient Voltage	---	400	---	mV	
Switching Frequency	---	330	---	kHz	Fixed
External Load Capacitance	330+	---	10000*	μF	+ for output voltage of 1.2V or below 470 μF is recommended
V _{onom}	---	0.8	---	V	Required for trim calculation
F	---	6448	---	Ω	Required for trim calculation
G	---	750	---	Ω	Required for trim calculation

*Please contact TDK-Lambda for technical support for very low ESR capacitor banks or if higher capacitance is required.

Electrical Characteristics: i7A12060A008V

Typical Efficiency vs. Input Voltage

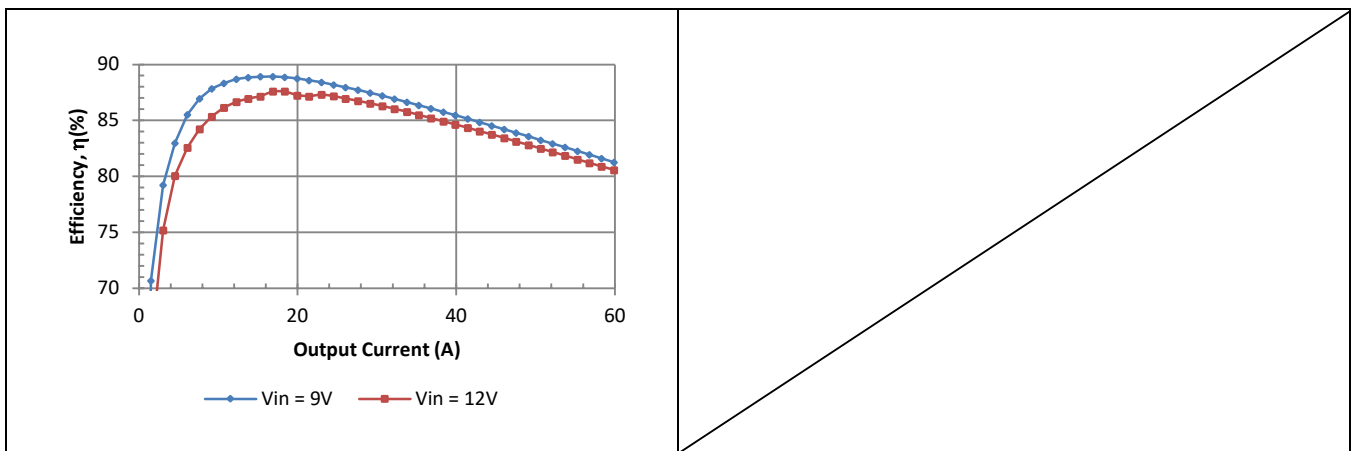
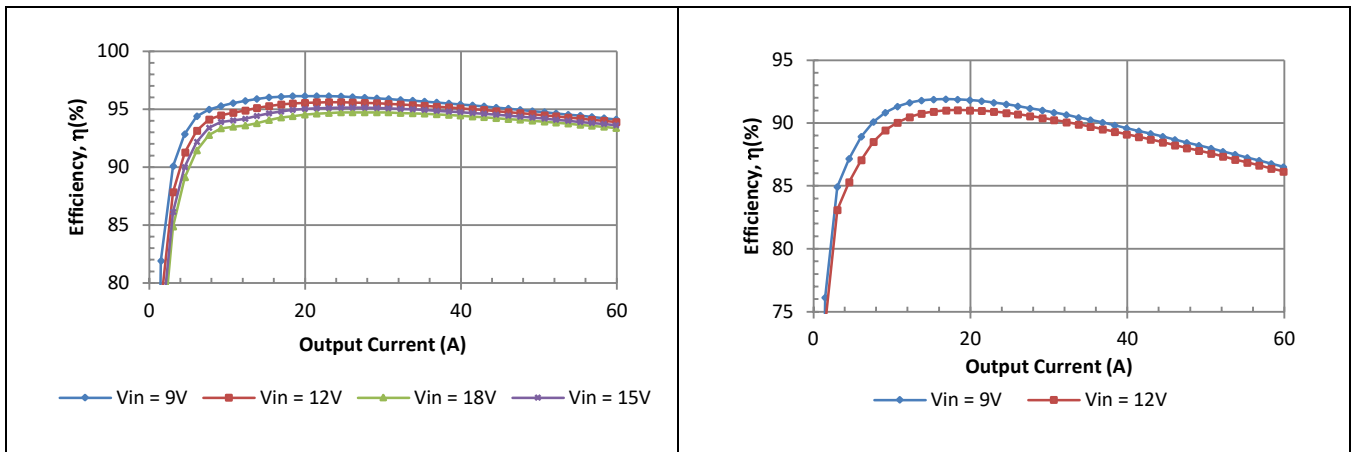
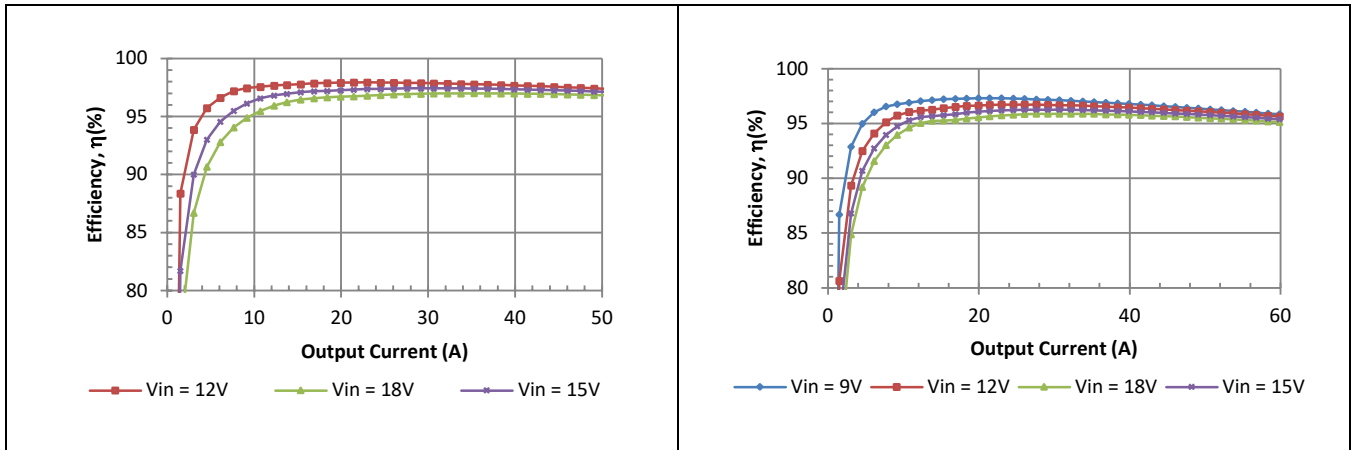

Electrical Characteristics: i7A12060A008V

Typical Power Dissipation vs. Input Voltage

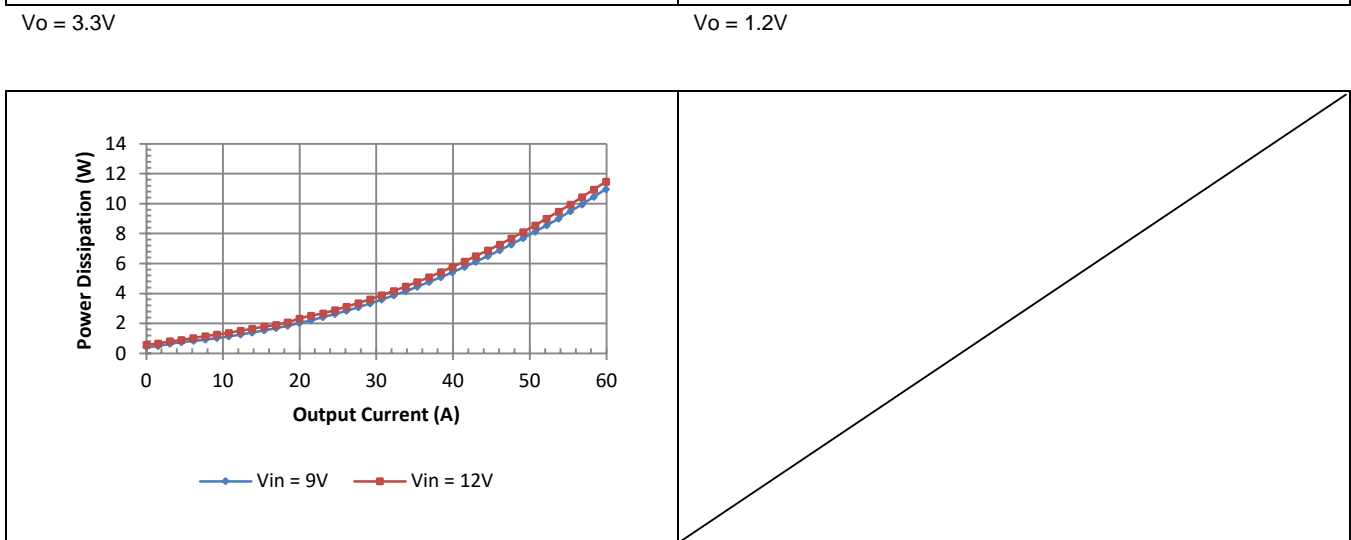
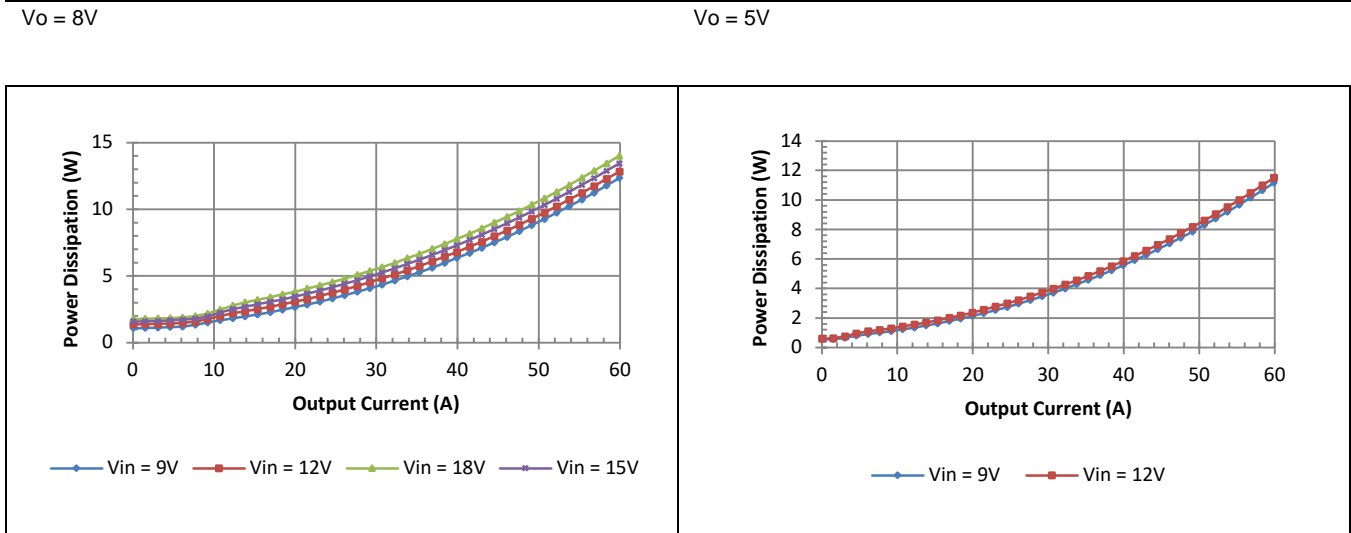
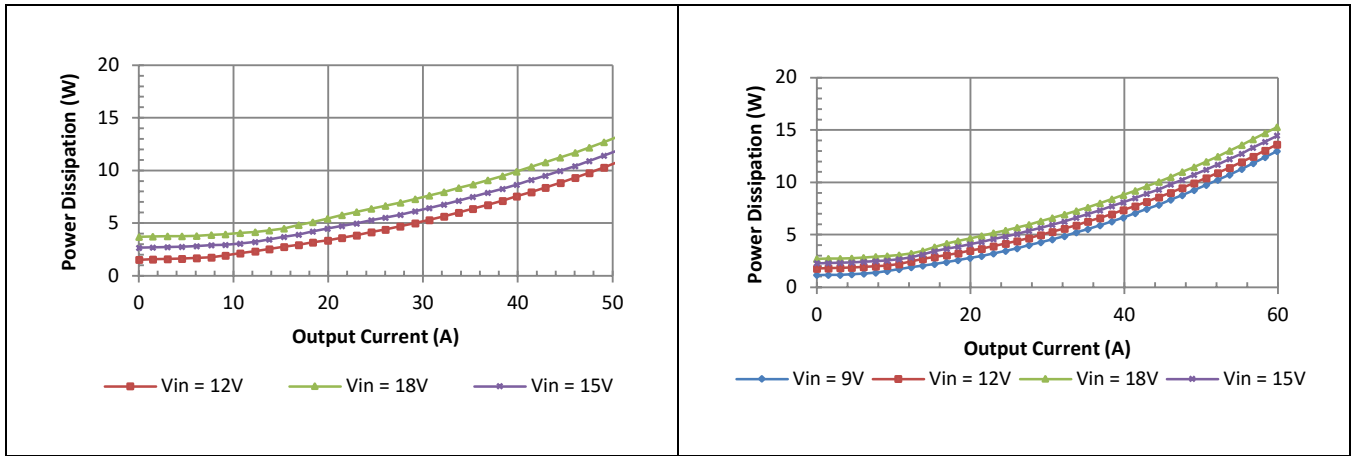

Electrical Characteristics: i7A12060A008V

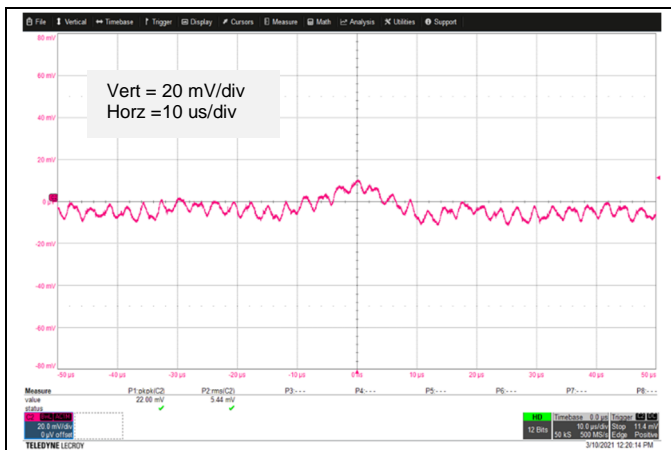

Vo = 5V Typical Output Ripple at nominal Input voltage and full load at Ta = 25 °C.

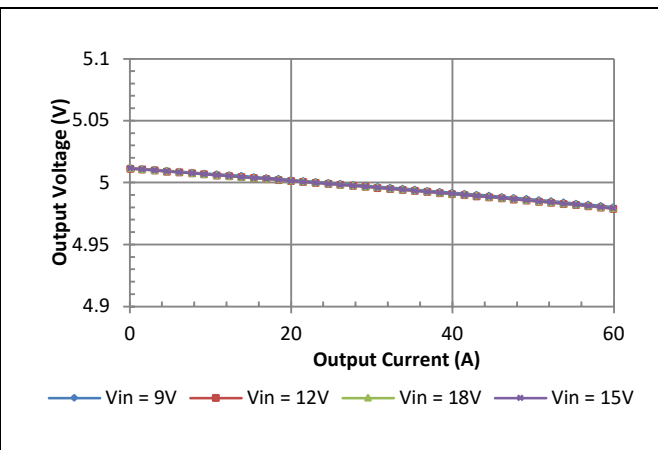

Vo = 5V Typical Load regulation.

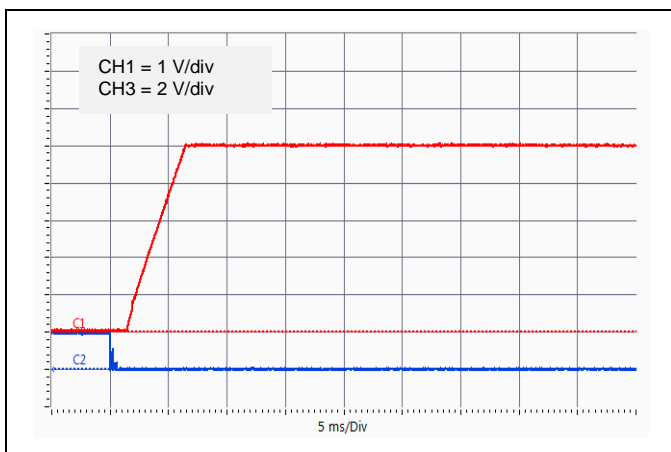

Vo = 5V Typical startup characteristic from On/Off at full load. CH1: Output Voltage, CH2: On/Off Signal.

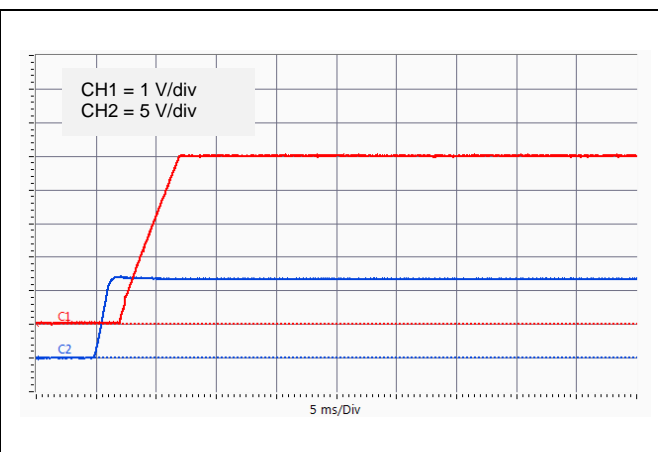

Vo = 5V Typical startup characteristic from input voltage at full load. CH1: Output Voltage, CH2: Input Voltage.

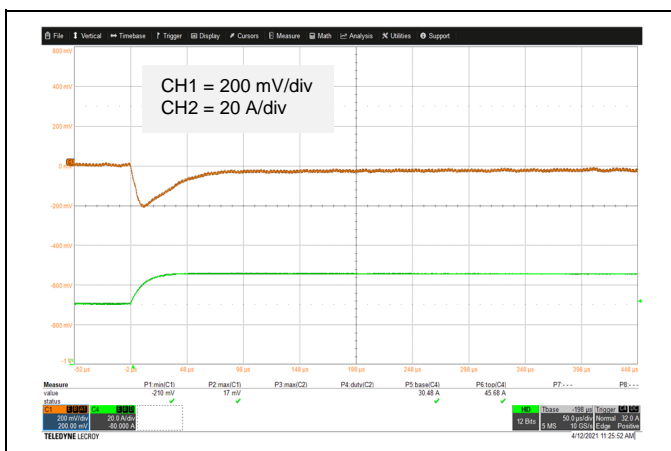

Vo = 3.3V Typical output voltage transient response to load step from 50% to 75% of full load with output current slew rate of 1A/ μ s, Cext = 330 μ F.

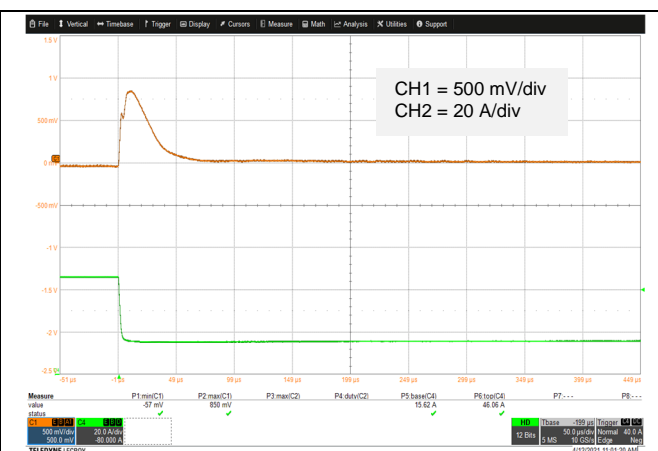

Vo = 3.3V Typical output voltage transient response to load step from 75% to 25% of full load with output current slew rate of 1A/ μ s, Cext = 330 μ F capacitor.

Electrical Characteristics: i7A12060A008V

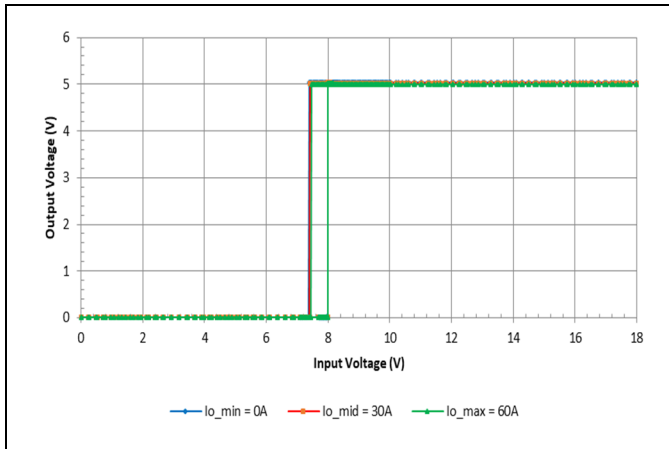

Vo = 5V Typical Output Voltage vs. Input Voltage Characteristics.

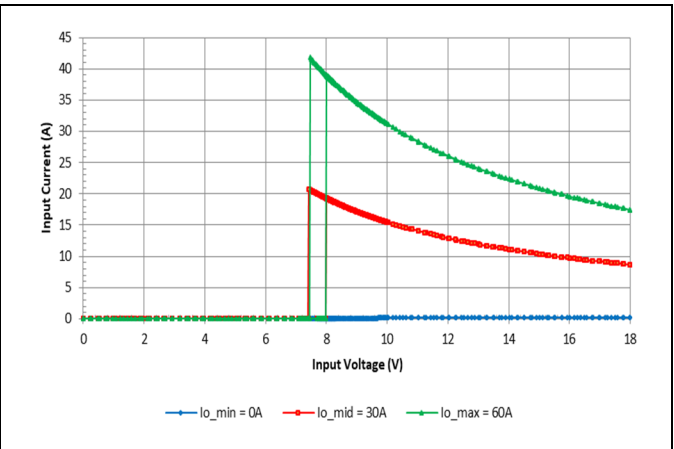

Vo = 5V Typical Input Current vs. Input Voltage Characteristics.

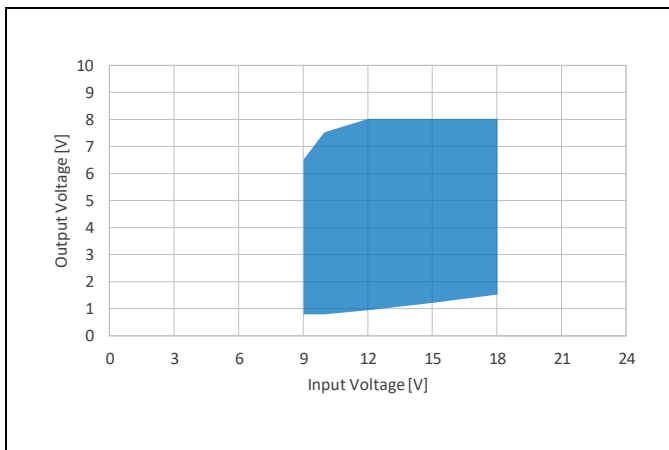

Output Voltage vs. Input Voltage Specified Operating Range.

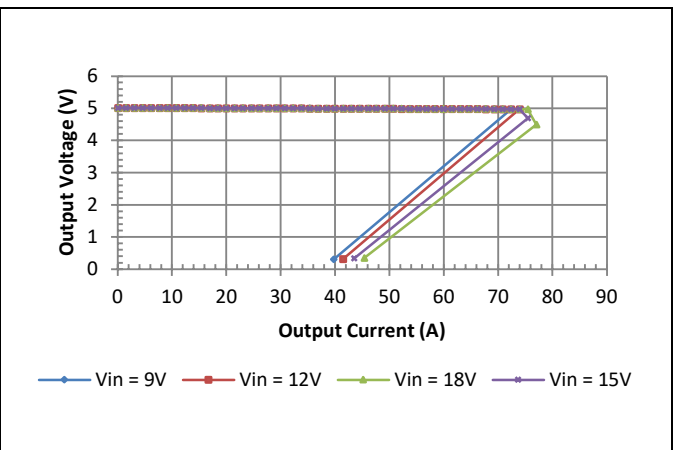

Vo = 5V Typical Current Limit Characteristics.

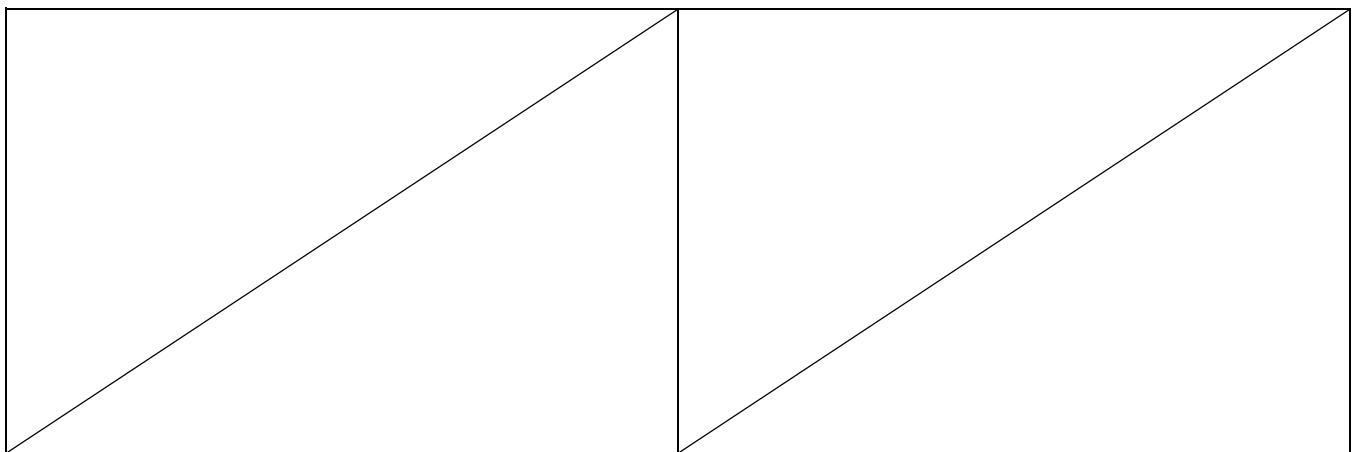

Thermal Performance: i7A12060A008V

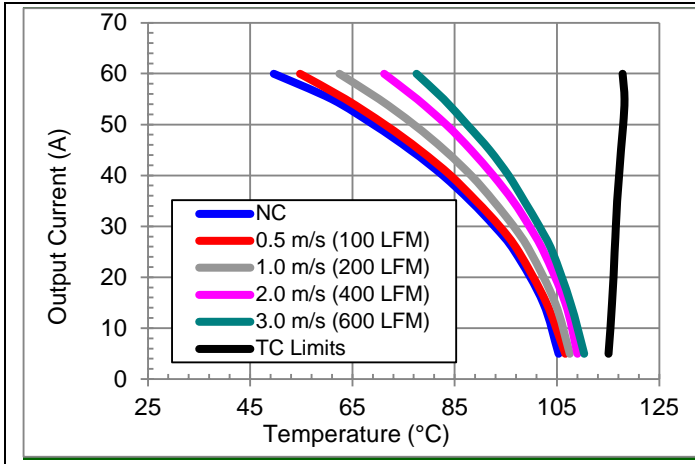

$V_{in} = 12V$, $V_o = 5V$ preliminary maximum output current vs. ambient temperature for natural convection NC (60lfm) to 3m/s (600 lfm) with airflow from pin 3 to pin 4.

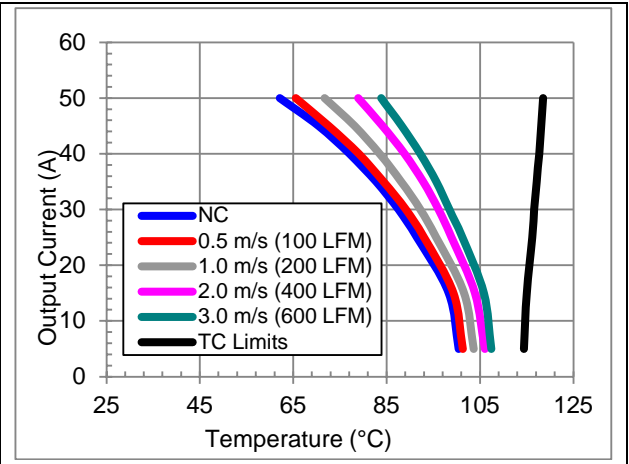

$V_{in} = 15V$, $V_o = 8V$ preliminary maximum output current vs. ambient temperature for natural convection NC (60lfm) to 3m/s (600 lfm) with airflow from pin 3 to pin 4.

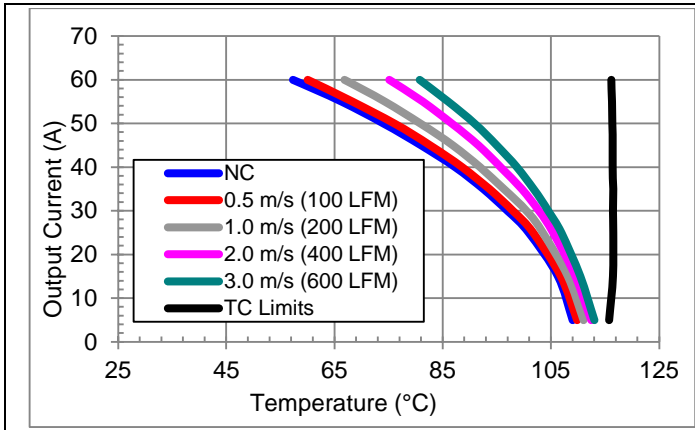

$V_{in} = 12V$, $V_o = 1.8V$ preliminary maximum output current vs. ambient temperature for natural convection NC (60lfm) to 3m/s (600 lfm) with airflow from pin 3 to pin 4.

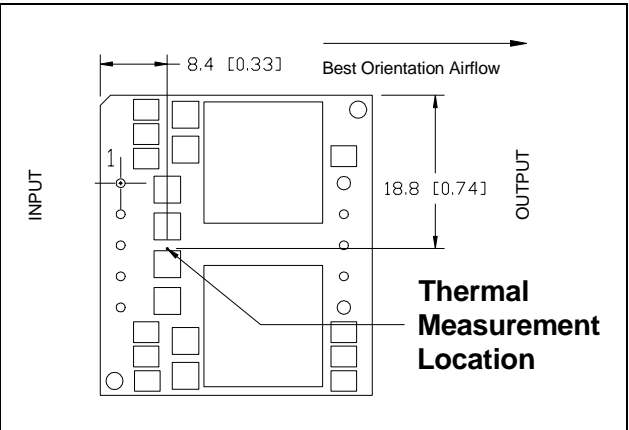

i7A12060A008V thermal measurement location – top view.

The thermal curves provided are based upon measurements made in TDK-Lambda's experimental test setup that is described in the Thermal Management section. Due to the large number of variables in system design, TDK-Lambda recommends that the user verify the module's thermal performance in the end application. The critical component should be thermocoupled and monitored, and should not exceed the temperature limit specified in the derating curve above. Due to the extremely wide range of operating points, it is important to verify thermal performance in the end application. The temperature can change significantly with operating input voltage. It is critical that the thermocouple be mounted in a manner that gives direct thermal contact or significant measurement errors may result. TDK-Lambda can provide modules with a thermocouple pre-mounted to the critical component for system verification tests.

Thermal Performance: i7A12060A008V (with baseplate -0C1)

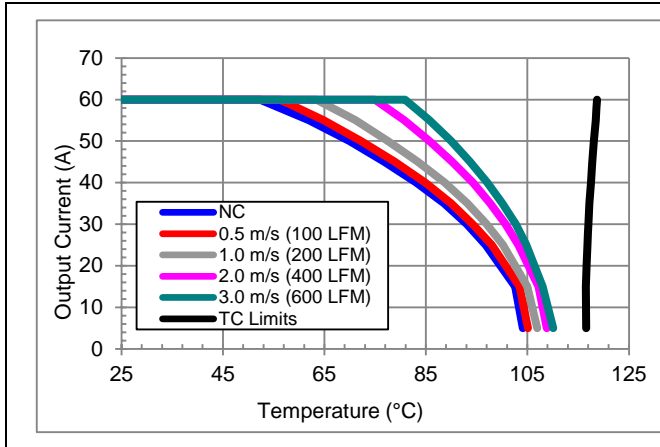

Vin = 12V, Vo = 5V preliminary maximum output current vs. ambient temperature for natural convection NC (60lfm) to 3m/s (600 lfm) with airflow from pin 3 to pin 4.

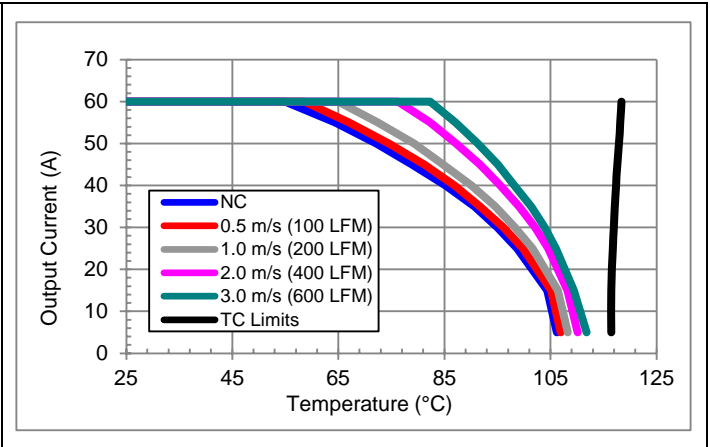

Vin = 12V, Vo = 3.3V preliminary maximum output current vs. ambient temperature for natural convection NC (60lfm) to 3m/s (600 lfm) with airflow from pin 3 to pin 4.

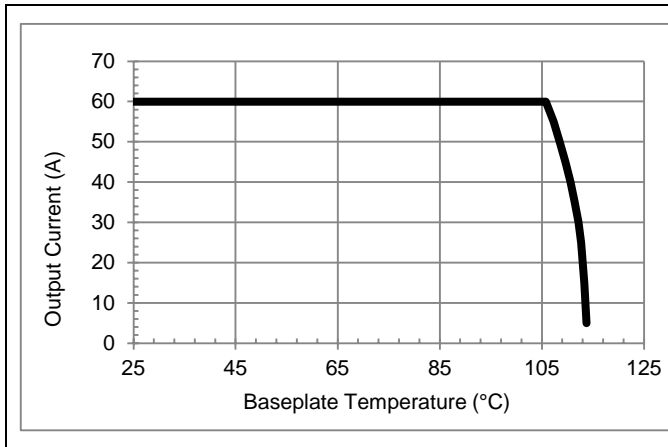

Typical Baseplate temperature versus output current derating curve for conduction cooling application with Vo = 5V.

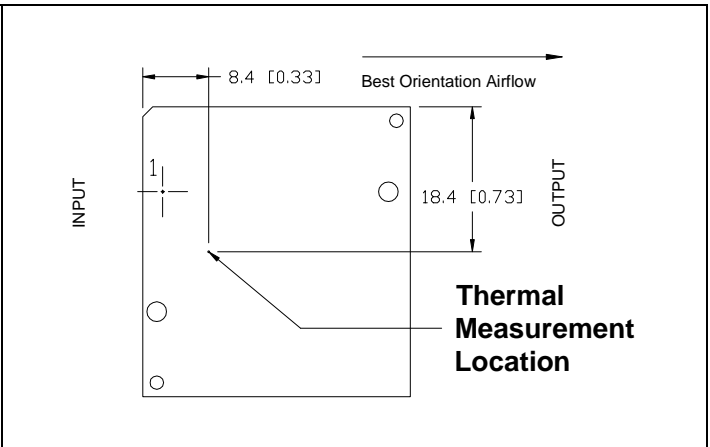

i7A12060A008V-xCx-R thermal measurement location – top view.

Thermal Performance: i7A12060A008V (with heatsink – 0F1)

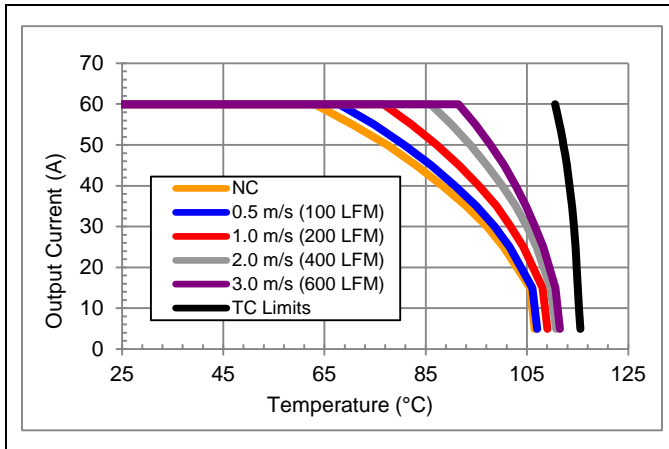

Vin = 12V, Vo = 5V preliminary maximum output current vs. ambient temperature for natural convection NC (60lfm) to 3m/s (600 lfm) with airflow from pin 3 to pin 4.

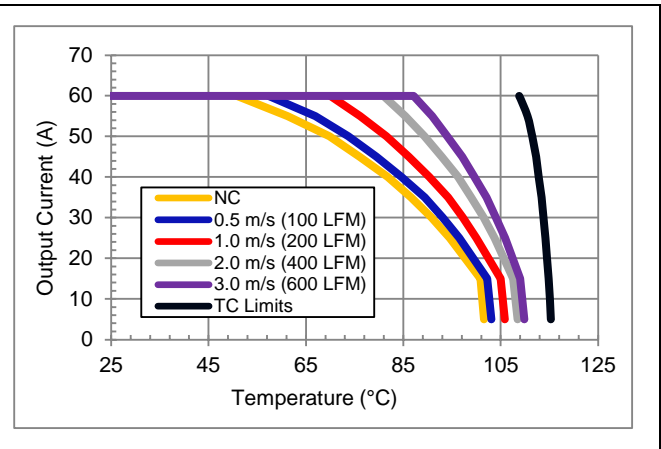

Vin = 18V, Vo = 5V preliminary maximum output current vs. ambient temperature for natural convection NC (60lfm) to 3m/s (600 lfm) with airflow from pin 3 to pin 4.

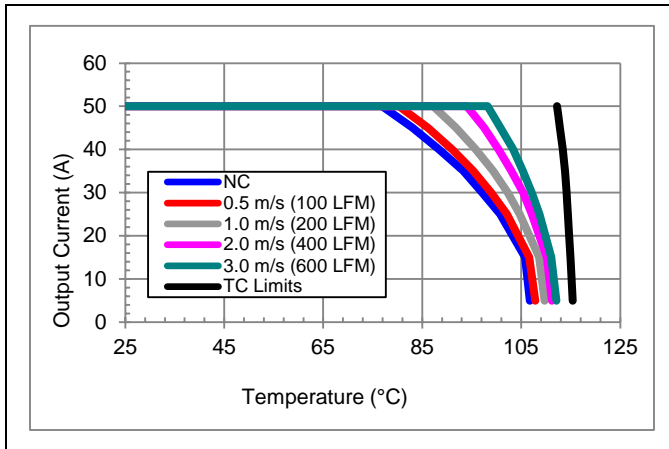

Vin = 12V, Vo = 8V preliminary maximum output current vs. ambient temperature for natural convection NC (60lfm) to 3m/s (600 lfm) with airflow from pin 3 to pin 4.

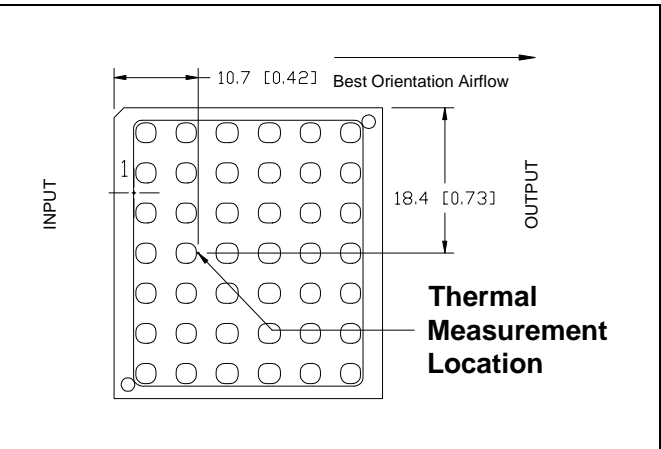

i7A12060A008V-xFx-R thermal measurement location – top view.

Electrical Data: i7A48020A033V

Characteristic	Min	Typ	Max	Unit	Notes & Conditions
Output Voltage Initial Setpoint	-2	-	+2	%	$V_o = 12V_{\text{setting}}$, $V_{in} = V_{in,nom}$; $I_o = I_{o,min}$; $T_c = 25\text{ }^\circ\text{C}$
Output Voltage Tolerance	-3.5	-	+3.5	%	Over all rated input voltage, load, and temperature conditions to end of life
Efficiency				%	$V_{in} = 48V$; $I_o = I_{o,max}$; $T_c = 25\text{ }^\circ\text{C}$
	$V_o = 5V$	92	---		
	$V_o = 12V$	96	---		
	$V_o = 18V$	97	---		
	$V_o = 24V$	98	---		
Line Regulation	---	0.2	---	%	$V_{in} = V_{in,min}$ to $V_{in,max}$
Load Regulation	---	0.3	---	%	$I_o = I_{o,min}$ to $I_{o,max}$
Output Current	0	---	20	A	Observe maximum power limit and input voltage derating
Output Current Limiting Threshold	---	30	---	A	$V_o = 0.9 \cdot V_{o,nom}$, $T_c < T_{c,max}$
Short Circuit Current	---	22	---	A	$V_o = 0.25V$, $T_c = 25\text{ }^\circ\text{C}$
Output Ripple and Noise Voltage	---	25	---	mVpp	Measured across one 22 μF ceramic capacitor – see input/output ripple measurement figure; BW = 20MHz.
Output Voltage Adjustment Range	3.3	---	32	V	
Output Voltage Sense Range	---	---	5	%	
Dynamic Response: Recovery Time	---	180	---	μs	$di/dt = 1A/\mu\text{s}$, $V_{in} = V_{in,nom}$; $V_o = 12V$, load step from 25% to 75% of $I_{o,max}$
Transient Voltage	---	500	---	mV	
Switching Frequency	---	330	---	kHz	Fixed
External Load Capacitance	330	---	10000*	μF	
$V_{o,nom}$	---	3.28	---	V	Required for trim calculation
F	---	16400	---	Ω	Required for trim calculation
G	---	511	---	Ω	Required for trim calculation

*Please contact TDK-Lambda for technical support for very low ESR capacitor banks or if higher capacitance is required.

Electrical Characteristics: i7A48020A033V

Typical Efficiency vs. Input Voltage

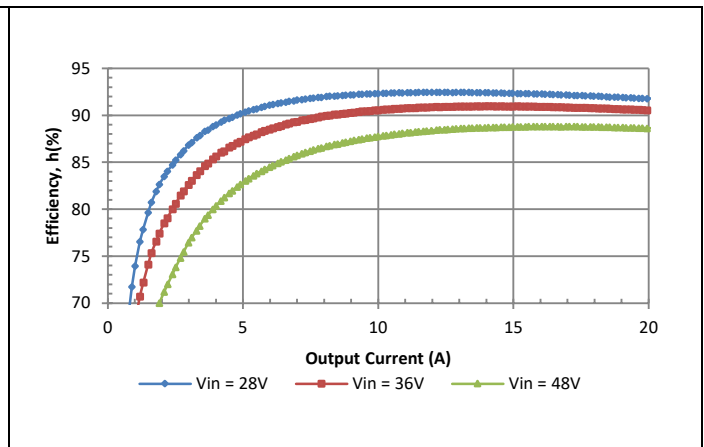
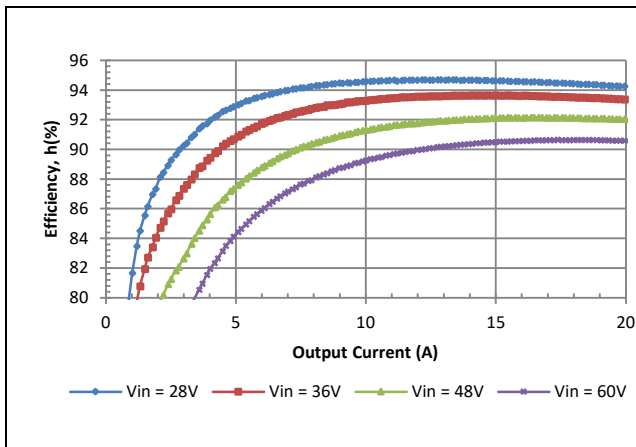
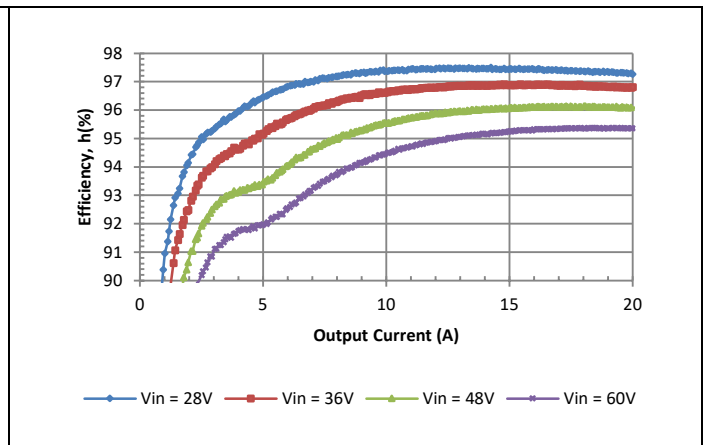
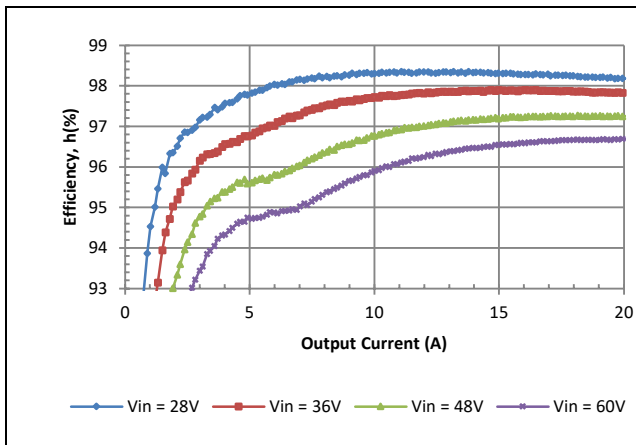
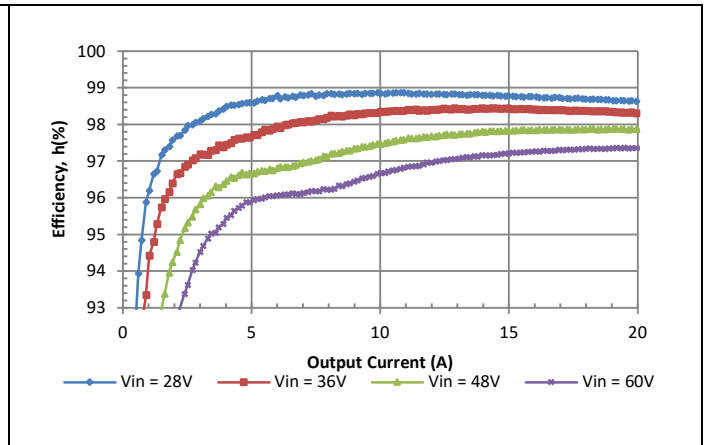
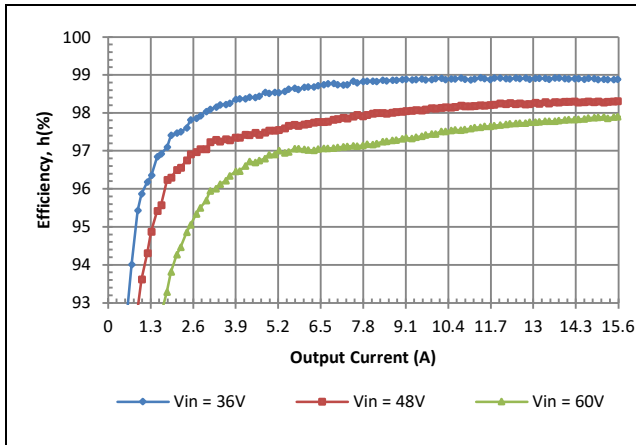

Electrical Characteristics: i7A48020A033V

Typical Power Dissipation vs. Input Voltage

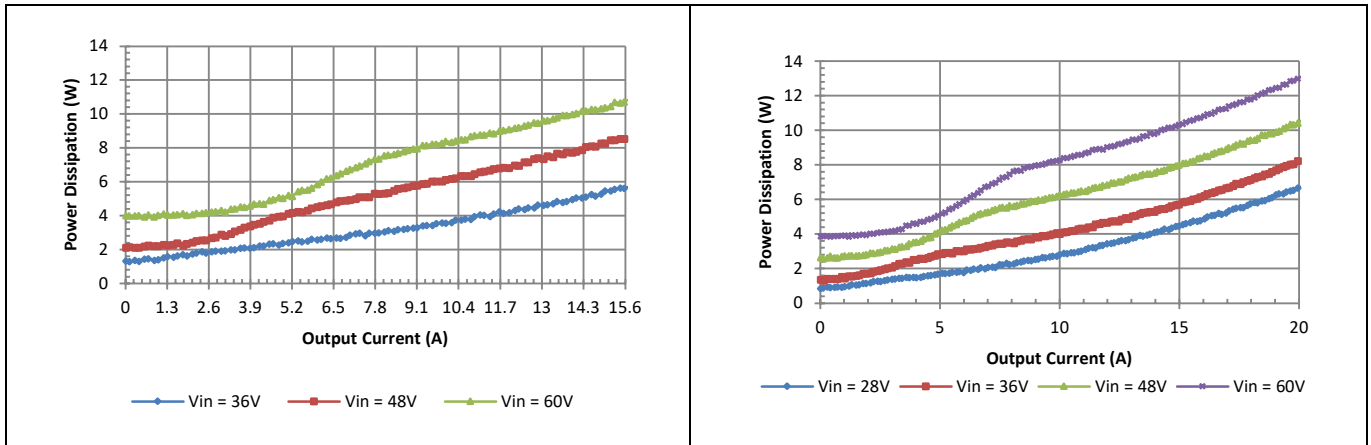

Vo = 32V

Vo = 24V

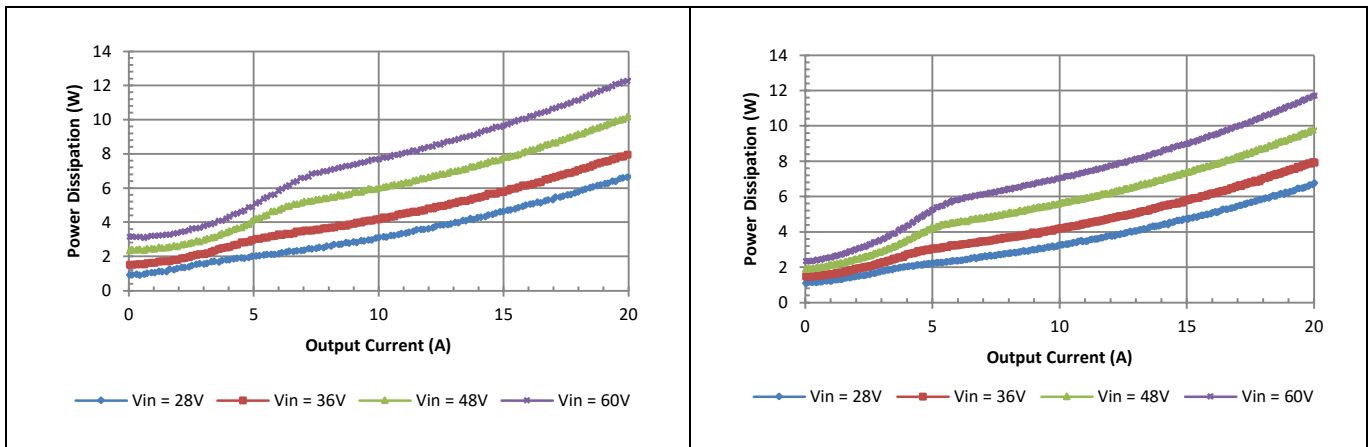

Vo = 18V

Vo = 12V

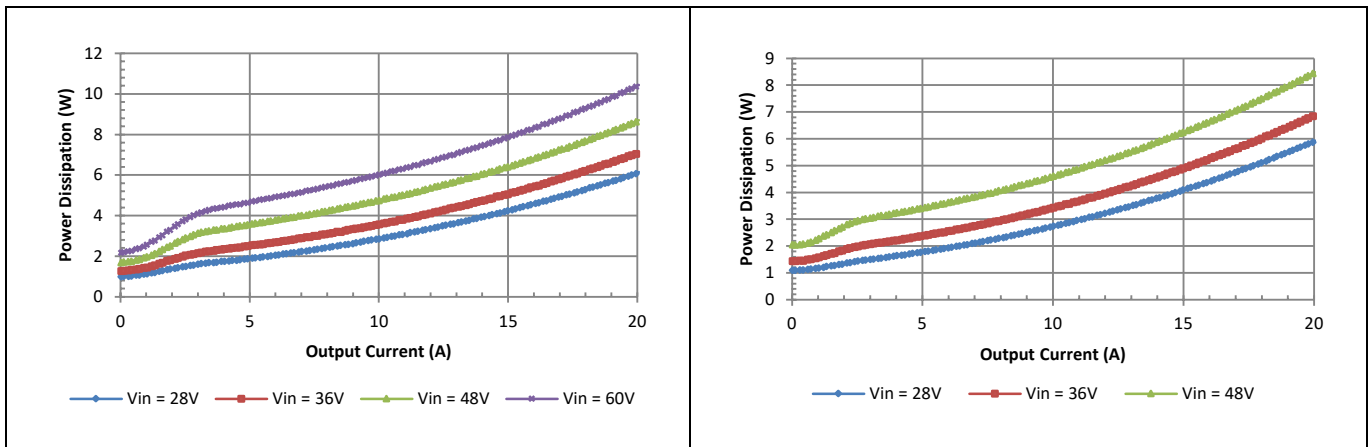

Vo = 5V

Vo = 3.3V

Electrical Characteristics: i7A48020A033V

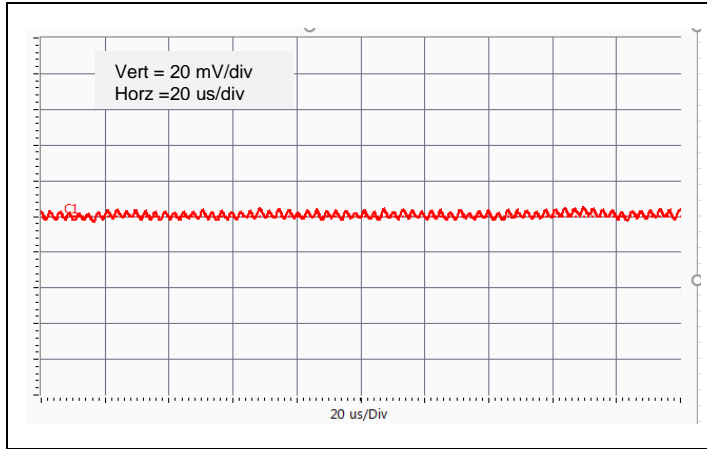

Vo = 12V Typical Output Ripple at nominal Input voltage and full load at Ta = 25 °C.

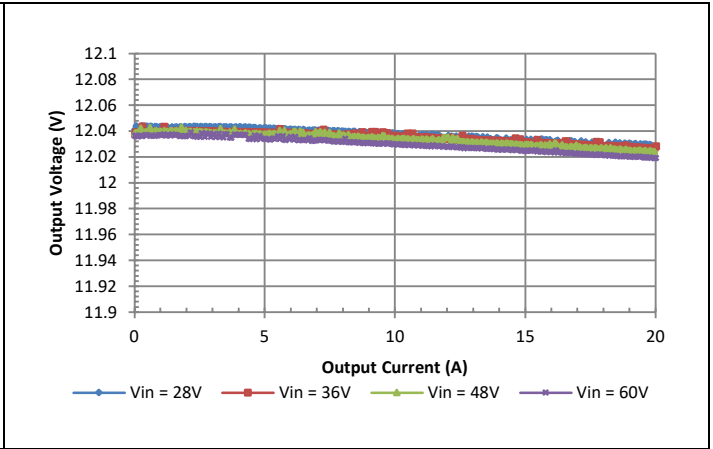

Vo = 12V typical load regulation

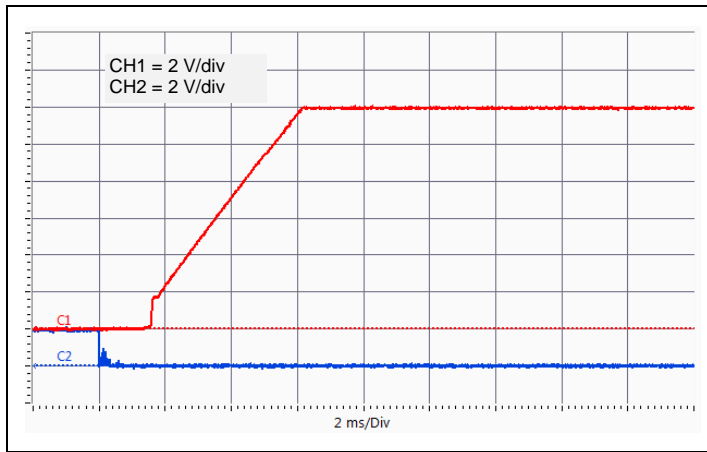

Vo = 12V Typical startup characteristic from On/Off at full load. CH1: Output Voltage, CH2: On/Off Signal.

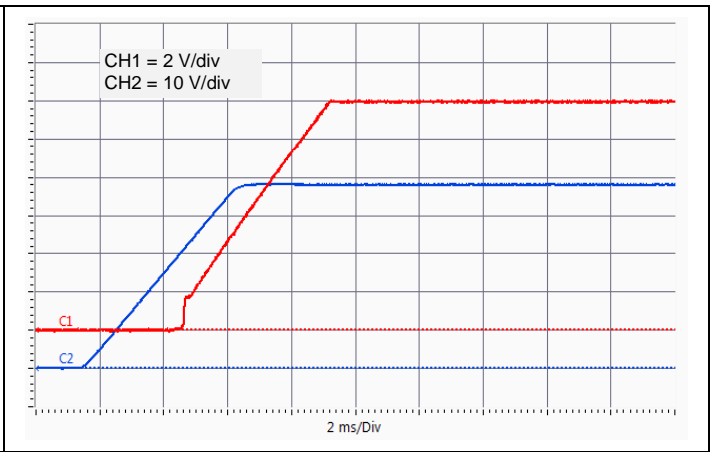

Vo = 12V Typical startup characteristic from input voltage at full load. CH1: Output Voltage, CH2: Input Voltage.

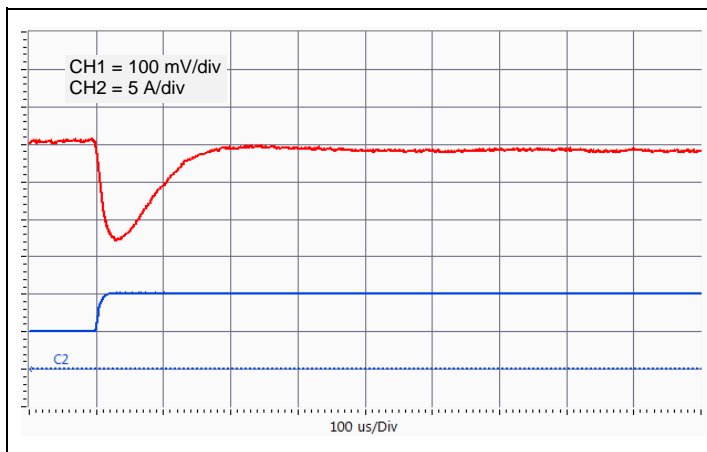

Vo = 12V Typical output voltage transient response to load step from 25% to 50% of full load with output current slew rate of 1A/ μ s, Cext = 330 μ F.

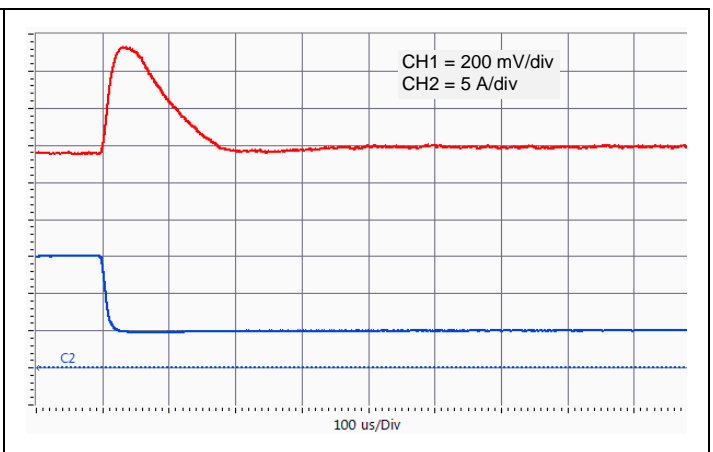

Vo = 12V Typical output voltage transient response to load step from 75% to 25% of full load with output current slew rate of 1A/ μ s, Cext = 330 μ F capacitor.

Electrical Characteristics: i7A48020A033V

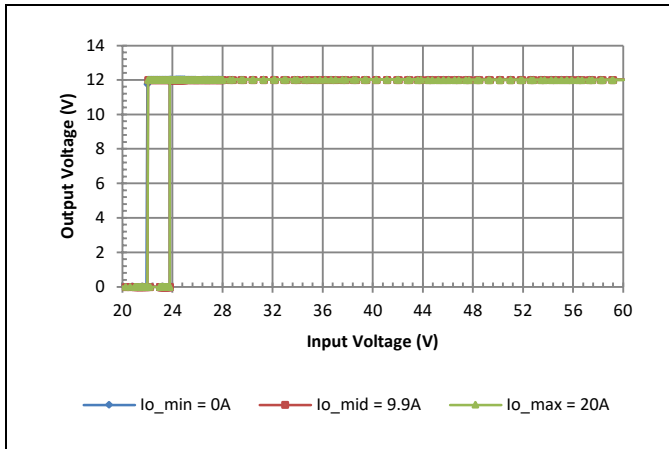

Vo = 12V Typical Output Voltage vs. Input Voltage Characteristics.

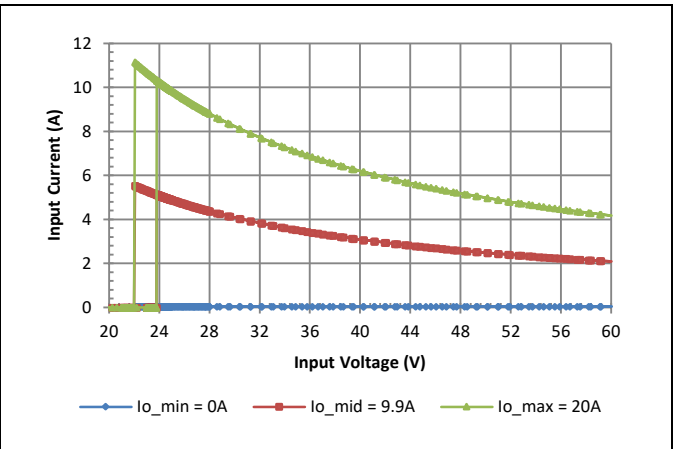

Vo = 12V Typical Input Current vs. Input Voltage Characteristics.

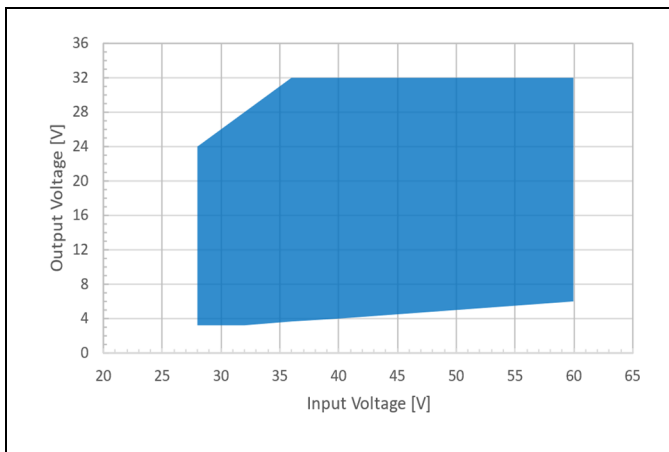

Output Voltage vs. Input Voltage Specified Operating Range.

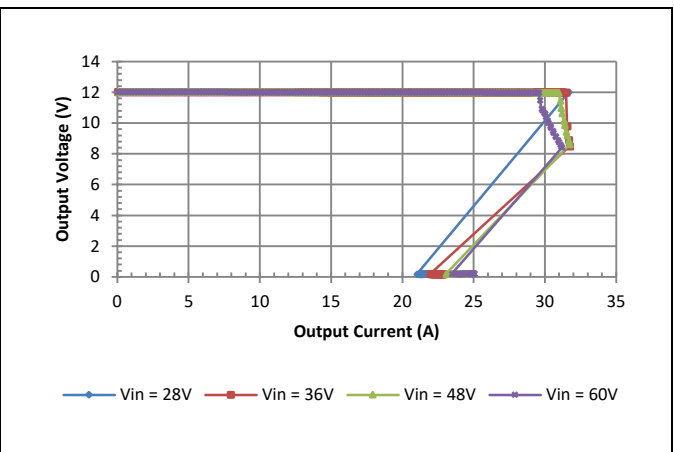

Vo = 12V Typical Current Limit Characteristics.

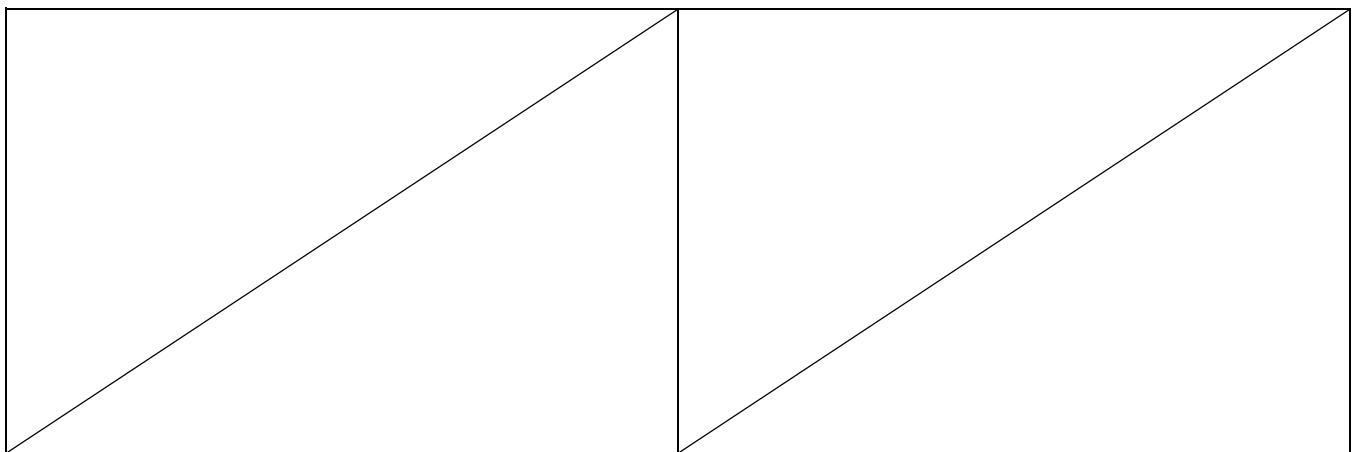

Thermal Performance: i7A48020A033V (Open frame -00x-R)

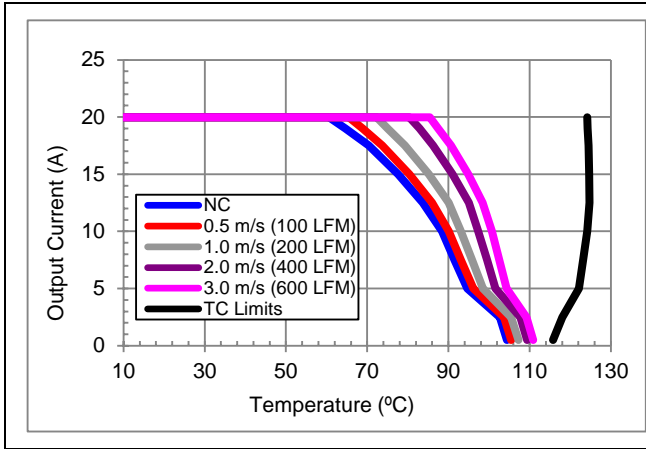

$V_{in} = 48V$, $V_o = 12V$ preliminary maximum output current vs. ambient temperature for natural convection NC (60lfm) to 3m/s (600 lfm) with airflow from pin 3 to pin 4.

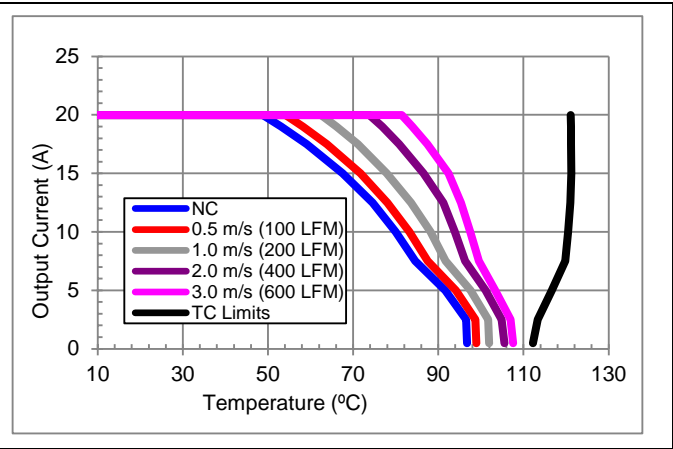

$V_{in} = 48V$, $V_o = 24V$ preliminary maximum output current vs. ambient temperature for natural convection NC (60lfm) to 3m/s (600 lfm) with airflow from pin 3 to pin 4.

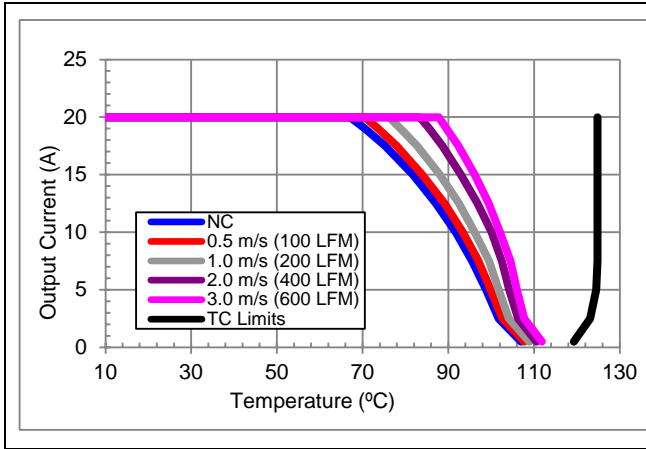

$V_{in} = 48V$, $V_o = 5V$ preliminary maximum output current vs. ambient temperature for natural convection NC (60lfm) to 3m/s (600 lfm) with airflow from pin 3 to pin 4.

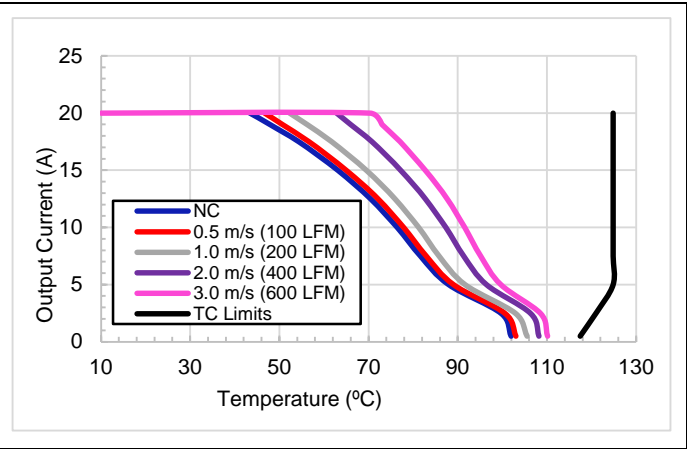

$V_{in} = 60V$, $V_o = 12V$ preliminary maximum output current vs. ambient temperature for natural convection NC (60lfm) to 3m/s (600 lfm) with airflow from pin 3 to pin 4.

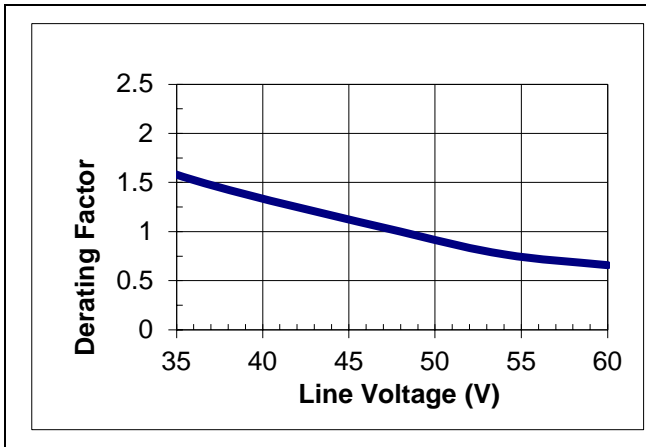

Typical output current derating versus line voltage with airflow 1m/s (200 lfm) and $T_a = 65^\circ C$.

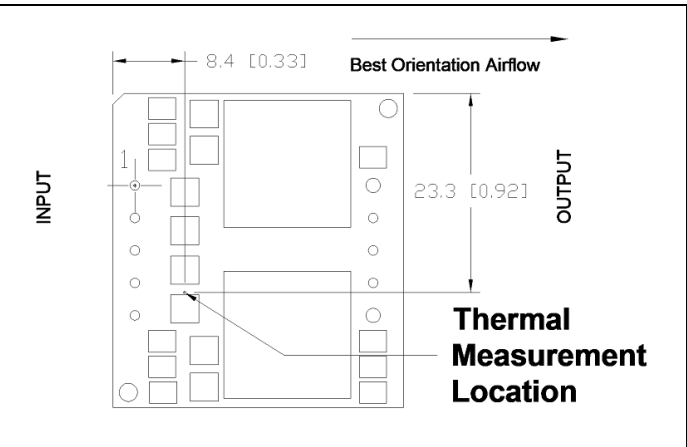

i7A48020A033V thermal measurement location – top view.

Thermal Performance: i7A48020A033V (with Baseplate -xCx-R)

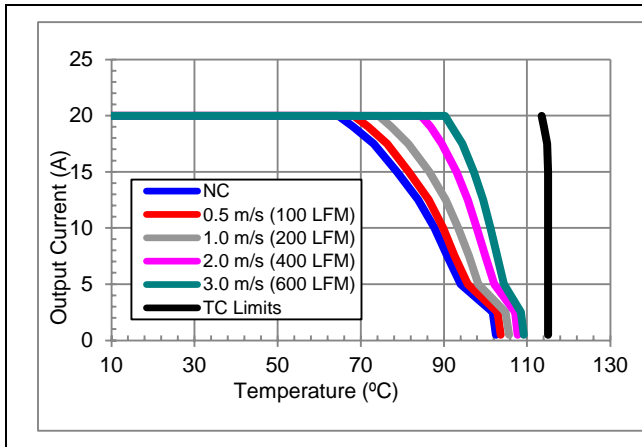

Vin = 48V, Vo = 12V preliminary maximum output current vs. ambient temperature for natural convection NC (60lfm) to 3m/s (600 lfm) with airflow from pin 3 to pin 4.

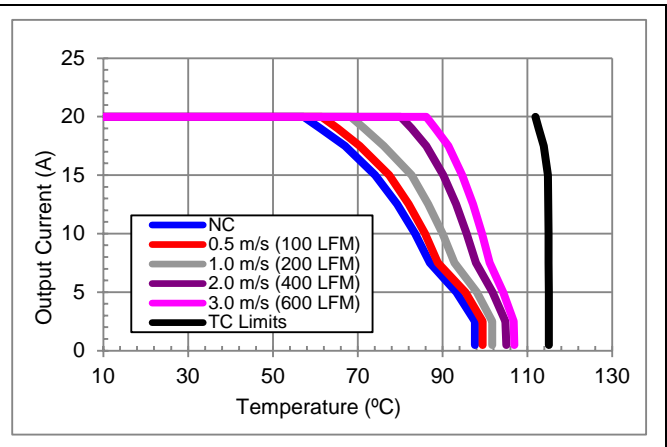

Vin = 48V, Vo = 24V preliminary maximum output current vs. ambient temperature for natural convection NC (60lfm) to 3m/s (600 lfm) with airflow from pin 3 to pin 4.

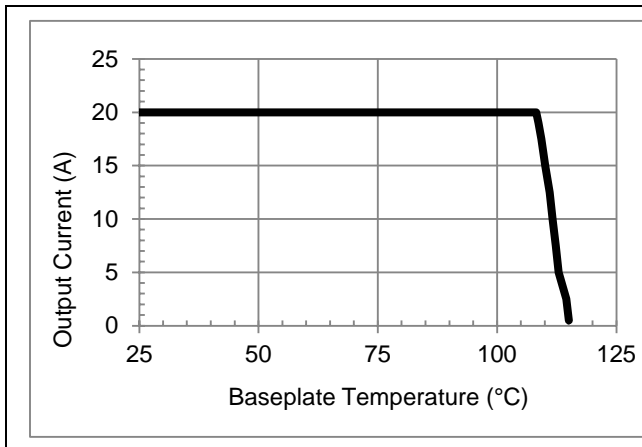

Typical baseplate temperature versus output current derating curve for conduction cooling application with Vo = 12V

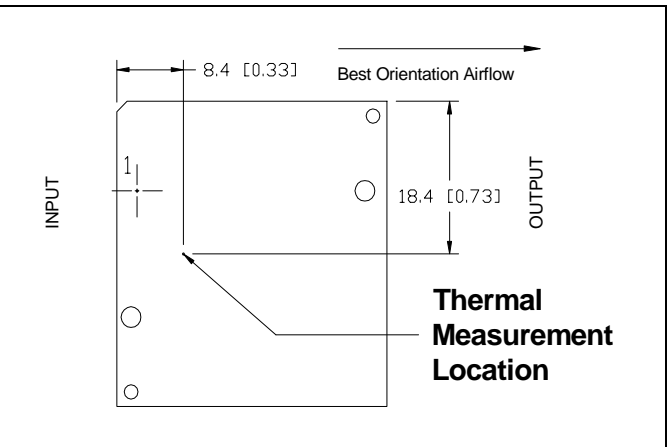

i7A48020A033V-xCx-R thermal measurement location – top view.

Thermal Performance: i7A48020A033V (with Heatsink – xFx-R)

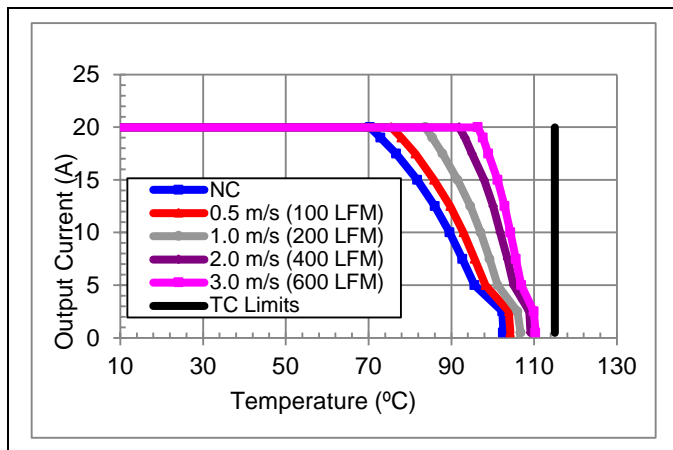

Vin = 48V, Vo = 12V preliminary maximum output current vs. ambient temperature for natural convection NC (60lfm) to 3m/s (600 lfm) with airflow from pin 3 to pin 4.

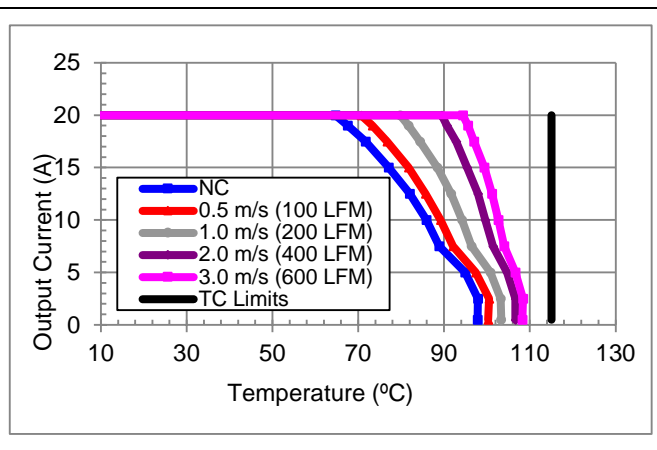

Vin = 48V, Vo = 24V preliminary maximum output current vs. ambient temperature for natural convection NC (60lfm) to 3m/s (600 lfm) with airflow from pin 3 to pin 4.

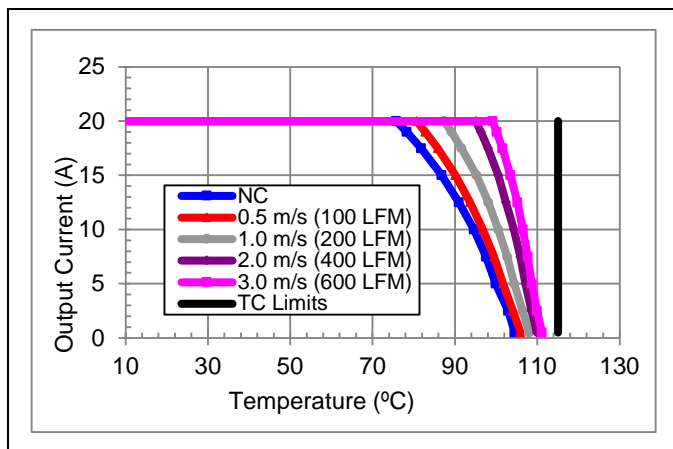

Vin = 48V, Vo = 5V preliminary maximum output current vs. ambient temperature for natural convection NC (60lfm) to 3m/s (600 lfm) with airflow from pin 3 to pin 4.

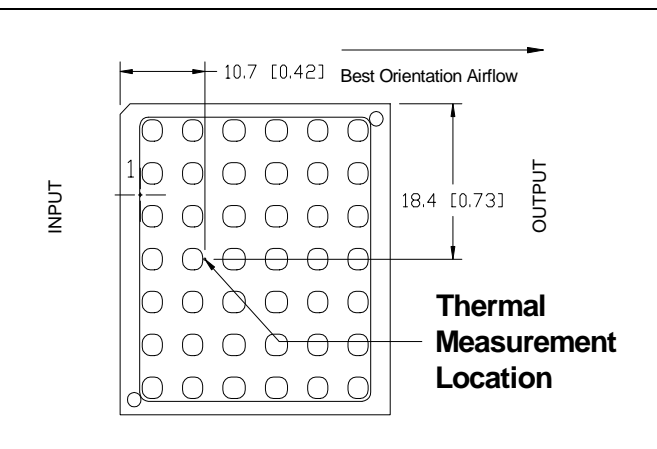

i7A4W020A033V-xFx-R thermal measurement location – top view.

The thermal curves provided are based upon measurements made in TDK-Lambda's experimental test setup that is described in the Thermal Management section. Due to the large number of variables in system design, TDK-Lambda recommends that the user verify the module's thermal performance in the end application. The critical component should be thermocoupled and monitored, and should not exceed the temperature limit specified in the derating curve above. Due to the extremely wide range of operating points, it is important to verify thermal performance in the end application. The temperature can change significantly with operating input voltage. It is critical that the thermocouple be mounted in a manner that gives direct thermal contact or significant measurement errors may result. TDK-Lambda can provide modules with a thermocouple pre-mounted to the critical component for system verification tests.

Thermal Management:

An important part of the overall system design process is thermal management; thermal design must be considered at all levels to ensure good reliability and lifetime of the final system. Superior thermal design and the ability to operate in severe application environments are key elements of a robust, reliable power module.

A finite amount of heat must be dissipated from the power module to the surrounding environment. This heat is transferred by the three modes of heat transfer: convection, conduction and radiation. While all three modes of heat transfer are present in every application, convection is the dominant mode of heat transfer in most applications. However, to ensure adequate cooling and proper operation, all three modes should be considered in a final system configuration.

The open frame design of the power module provides an air path to individual components. This air path improves convection cooling to the surrounding environment, which reduces areas of heat concentration and resulting hot spots.

Test Setup:

The thermal performance data of the power module is based upon measurements obtained from a wind tunnel test with the setup shown in the wind tunnel figure. This thermal test setup replicates the typical thermal environments encountered in most modern electronic systems with distributed power architectures. The electronic equipment in networking, telecom, wireless, and advanced computer systems operates in similar environments and utilizes vertically mounted PCBs or circuit cards in cabinet racks.

The power module, as shown in the figure, is mounted on a printed circuit board (PCB) and is vertically oriented within the wind tunnel. The cross section of the airflow passage is rectangular. The spacing between the top of the module and a parallel facing PCB is kept at a constant (0.5 in). The power module's orientation with respect to the airflow direction can have a significant impact on the module's thermal performance.

Thermal Derating:

For proper application of the power module in a given thermal environment, output current derating curves are provided as a design guideline on the Thermal Performance section for the power module of interest. The module temperature should be measured in the final system configuration to ensure proper thermal management of the power module. For thermal performance verification, the module temperature should be measured at the component indicated in the thermal measurement location figure on the thermal performance page for the power module of interest.

In all conditions, the power module should be operated below the maximum operating temperature shown on the derating curve. For improved design margins and enhanced system reliability, the power module may be operated at temperatures below the maximum rated operating temperature.

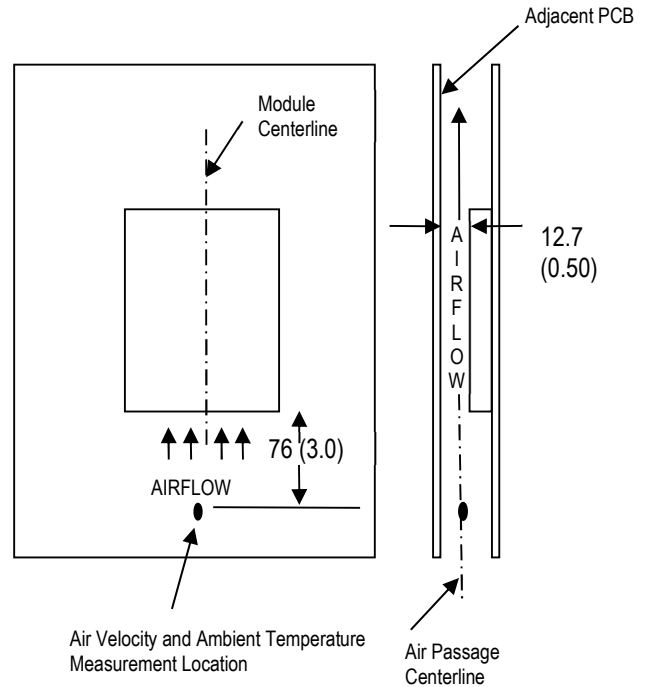

Wind Tunnel Test Setup Figure
 Dimensions are in millimeters and (inches).

Heat transfer by convection can be enhanced by increasing the airflow rate that the power module experiences. The maximum output current of the power module is a function of ambient temperature (T_{AMB}) and airflow rate as shown in the thermal performance figures on the thermal performance page for the power module of interest. The curves in the figures are shown for natural convection through 3 m/s (600 ft/min). The data for the natural convection condition has been collected at 0.3 m/s (60 ft/min) of airflow, which is the typical airflow generated by other heat dissipating components in many of the systems that these types of modules are used in. In the final system configurations, the airflow rate for the natural convection condition can vary due to temperature gradients from other heat dissipating components.

Operating Information:

Over-Current Protection:

The power modules have short circuit protection to protect the module during severe overload conditions. During overload conditions, the power modules may protect themselves by lowering output voltage to reduce the output power. They may enter a hiccup mode if the over temperature threshold is reached. The modules will operate normally once the output current and temperature return to the specified operating range. Long term operation outside the rated conditions and prior to the protection engaging is not recommended unless measures are taken to ensure the module's thermal limits are being observed.

Remote On/Off:

The power modules have an internal remote On/Off circuit. The user must supply a compatible switch between the GND pin and the On/Off pin. The maximum voltage generated by the power module at the On/Off terminal is 8V. The maximum allowable leakage current of the switch is 10 uA for negative logic and 5uA for positive logic. The switch must be capable of maintaining a low signal $V_{on/off} < 0.25V$ while sinking 1mA. A voltage source should not be applied to the On/Off terminal.

The standard On/Off is negative logic. In the circuit configuration shown the power module will turn on if the external switch is on and it will be off if the external switch is off. If the negative logic feature is not being used, terminal 2 should be connected to ground.

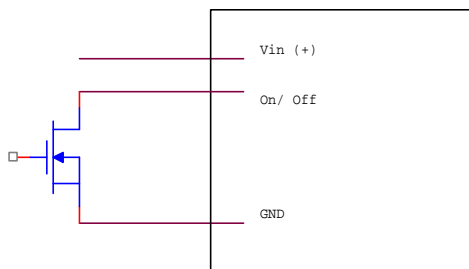

On/Off Circuit for positive or negative logic

An optional positive logic On/Off logic is available. In the circuit configuration shown the power module will turn off if the external switch is on and it will be on if the switch is off and the On/Off pin is open. If the positive logic feature is not being used, terminal 2 should be left open.

To avoid possible high power loss and overheating of components prior to under voltage lockout engaging, i7A modules should be turned off using the remote On/Off feature if the input voltage discharges with a slew rate slower than 1V/ms.

Remote Sense:

The power modules feature remote sense to compensate for the effect of output distribution drops. The output voltage sense range defines the maximum voltage allowed between the output power and sense terminals, and it is found on the electrical data page for the power module of interest. If the remote sense feature is not being used, the Sense terminal should be connected to the Vo terminal.

The output voltage at the Vo terminal can be increased by either the remote sense or the output voltage adjustment feature. The maximum voltage increase allowed is the larger of the remote sense range or the output voltage adjustment range; it is not the sum of both. As the output voltage increases due to the use of the remote sense, the maximum output current may need to be decreased for the power module to remain below its maximum power rating.

Output Voltage Adjustment:

The output voltage of the power module may be adjusted by using an external resistor connected between the Vout trim terminal and GND terminal. If the output voltage adjustment feature is not used, trim terminal should be left open. Care should be taken to avoid injecting noise into the power module's trim pin.

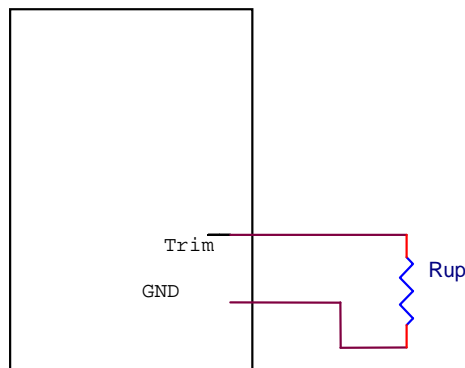

Circuit to increase output voltage

With a resistor between the trim and GND terminals, the output voltage is adjusted up. To adjust the output voltage from $V_{o,nom}$ to $V_{o,up}$ the trim resistor should be chosen according to the following equation:

$$R_{up} = \left(\frac{F}{V_{o,up} - V_{onom}} \right) - G$$

The values of $V_{o,nom}$, G , and F are found in the electrical data section for the power module of interest. The maximum power available from the power module is fixed. As the output voltage is trimmed up, the maximum output current must be decreased to maintain the maximum rated power of the module.

Example 1: i7A4W033A033V to be trimmed up to 12V

Given:

$$F = 16400$$

$$G = 750$$

$$V_{o,nom} = 3.28$$

$$V_{o,up} = 12 \text{ (desired output voltage)}$$

Then,

$$R_{up} = \left(\frac{16400}{12 - 3.28} \right) - 750 = \mathbf{1130 \Omega}$$

Trim Table for i7A48020A033V (20A)

Vout (V)	Ru (ohm)
5	9.02K
12	1.37K
18	603
28	152

Trim Table for i7A4W033A033V (33A)

Vout (V)	Ru (ohm)
5	8.78k
12	1.13k
18	364
24	42

Trim Table for i7A24045A033V (45A)

Vout (V)	Ru (ohm)
5	8.71k
12	1.05k
15	574

Trim Table for i7A12060A008V (60A)

Vout (V)	Ru (ohm)
1.2	15.4K
1.8	5.7K
5	785
8	145

Over Current Protection Adjustment:

On modules including this feature, a resistor can be added between Pin 5 and GND pin to reduce the over current protection set point and short circuit current. Running the module beyond rated full load is not recommended, so this feature can be useful to reduce device stress and avoid possible over temperature conditions in situations where over loading may occur, such as charging large output capacitors.

The current limit point varies depending upon output voltage, input voltage and operating temperature.

If the Over Current Protection Adjustment feature is not being used, then pin 5 can be left open.

For additional assistance using this feature, please contact TDK-Lambda technical support.

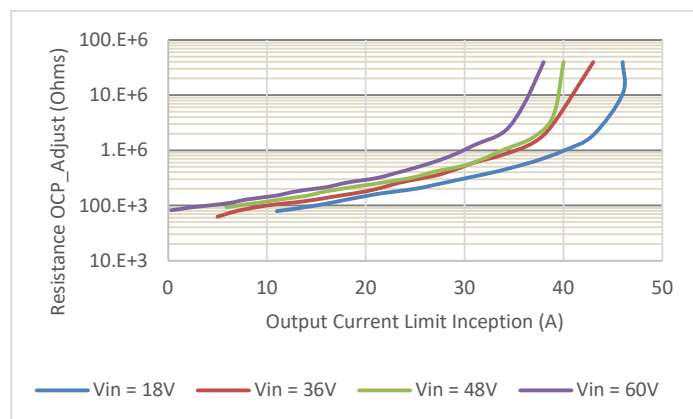

Typical OCP adjustment of i7A4W033A033V module with Vout = 15V

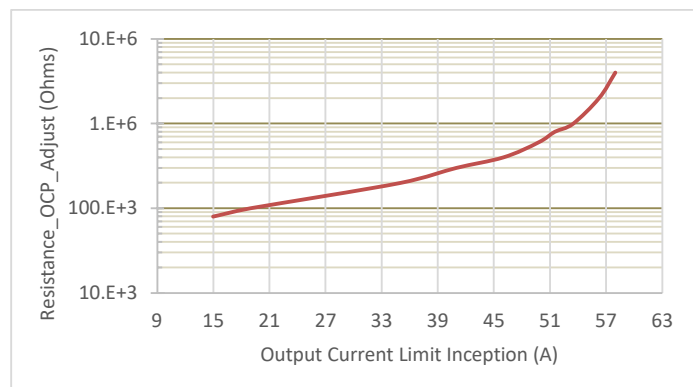

Typical i7A12060A008V OCP adjustment with Vin = 12V, Vout = 8V

EMC Considerations:

TDK-Lambda power modules are designed for use in a wide variety of systems and applications. For assistance with designing for EMC compliance, please contact TDK-Lambda technical support.

Input Impedance:

The source impedance of the power feeding the DC/DC converter module will interact with the DC/DC converter. To minimize the interaction, low-ESR capacitors should be located at the input to the module. It is recommended that a 220 to 440 μF input capacitor be placed near the module.

Input / Output Ripple and Noise Measurements:

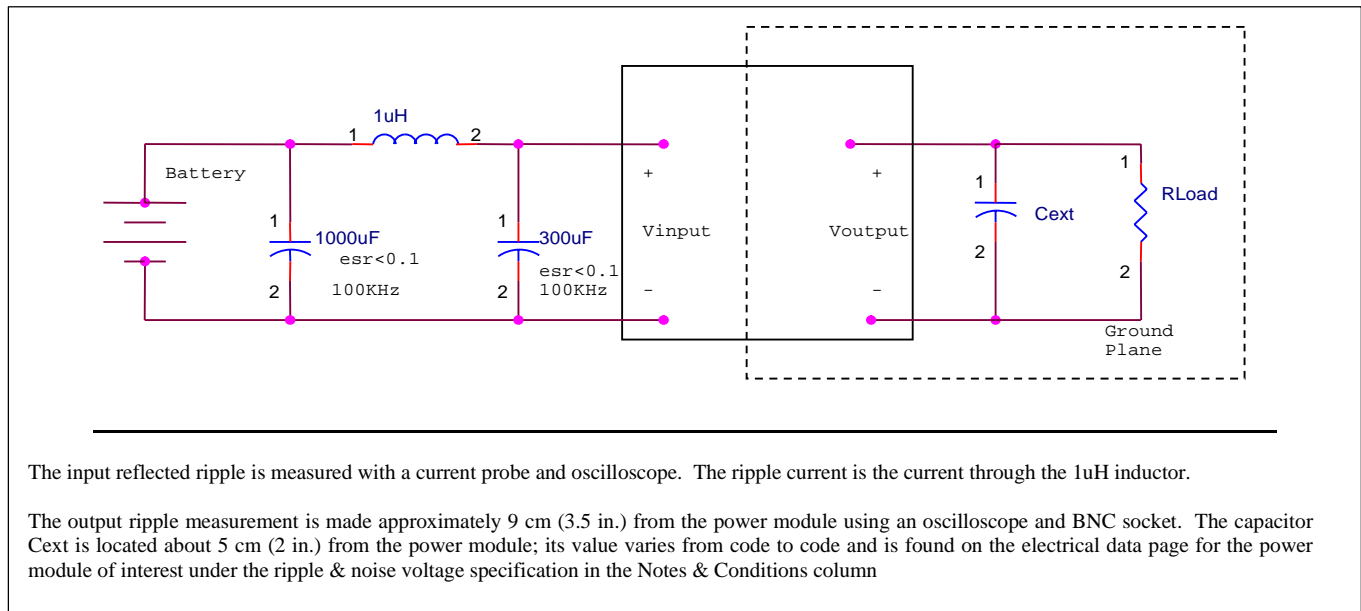

Reliability:

The power modules are designed using TDK-Lambda's stringent design guidelines for component derating, product qualification, and design reviews. The MTBF is calculated to be greater than 5 million hours at full output power and $T_a = 40^\circ\text{C}$ using the Telcordia SR-332 calculation method.

Quality:

TDK-Lambda's product development process incorporates advanced quality planning tools such as FMEA and Cpk analysis to ensure designs are robust and reliable. All products are assembled at ISO certified assembly plant.

Warranty:

TDK-Lambda's comprehensive line of power solutions includes efficient, high-density DC-DC converters. TDK-Lambda offers a three-year limited warranty. Complete warranty information is listed on our web site or is available upon request from TDK-Lambda.

Safety Considerations:

As of the publishing date, certain safety agency approvals may have been received on the i7A series and others may still be pending. Check with TDK-Lambda for the latest status of safety approvals on the i7A product line.

For safety agency approval of the system in which the DC-DC power module is installed, the power module must be installed in compliance with the creepage and clearance requirements of the safety agency.

To preserve maximum flexibility, the power modules are not internally fused. The external input line very fast acting fuse is required by safety agencies, but rating may vary by model number. Please refer to safety agency information. A lower value fuse can be selected based upon the maximum dc input current and maximum inrush energy of the power module.

Information furnished by TDK-Lambda is believed to be accurate and reliable. However, TDK-Lambda assumes no responsibility for its use, nor for any infringement of patents or other rights of third parties, which may result from its use. No license is granted by implication or otherwise under any patent or patent rights of TDK-Lambda. TDK components are not designed to be used in applications, such as life support systems, wherein failure or malfunction could result in injury or death. All sales are subject to TDK-Lambda's Terms and Conditions of Sale, which are available upon request. Specifications are subject to change without notice.



TDK-Lambda France SAS

Tel: +33 1 60 12 71 65
 ttf.fr.powersolutions@tdk.com
 www.emea.lambda.tdk.com/fr



Italy Sales Office

Tel: +39 02 61 29 38 63
 ttf.it.powersolutions@tdk.com
 www.emea.lambda.tdk.com/it



Netherlands

tfn.nl.powersolutions@tdk.com
 www.emea.lambda.tdk.com/nl



TDK-Lambda Germany GmbH

Tel: +49 7841 666 0
 tlq.powersolutions@tdk.com
 www.emea.lambda.tdk.com/de



Austria Sales Office

Tel: +43 2256 655 84
 tlq.at.powersolutions@tdk.com
 www.emea.lambda.tdk.com/at



Switzerland Sales Office

Tel: +41 44 850 53 53
 tlq.ch.powersolutions@tdk.com
 www.emea.lambda.tdk.com/ch



Nordic Sales Office

Tel: +45 8853 8086
 tlq.dk.powersolutions@tdk.com
 www.emea.lambda.tdk.com/dk



TDK-Lambda UK Ltd.

Tel: +44 (0) 12 71 85 66 66
 tlu.powersolutions@tdk.com
 www.emea.lambda.tdk.com/uk



TDK-Lambda Ltd.

Tel: +9 723 902 4333
 tli.powersolutions@tdk.com
 www.emea.lambda.tdk.com/il-en



TDK-Lambda Americas

Tel: +1 800-LAMBDA-4 or 1-800-526-2324
 tla.powersolutions@tdk.com
 www.us.lambda.tdk.com



TDK Electronics do Brasil Ltda

Tel: +55 11 3289-9599
 sales.br@tdk-electronics.tdk.com
 www.tdk-electronics.tdk.com/en



TDK-Lambda Corporation

Tel: +81-3-6778-1113
 www.jp.lambda.tdk.com



TDK-Lambda (China) Electronics Co. Ltd.

Tel: +86 21 6485-0777
 tlc.powersolutions@tdk.com
 www.lambda.tdk.com.cn



TDK-Lambda Singapore Pte Ltd.

Tel: +65 6251 7211
 tfs.marketing@tdk.com
 www.sg.lambda.tdk.com



TDK India Private Limited, Power Supply Division

Tel: +91 80 4039-0660
 mathew.philip@tdk.com
 www.sg.lambda.tdk.com

