

PXC-M10xxW Dual Output Series: DC-DC Converter Module

9 ~ 36 VDC and 18~ 75 VDC input; ± 5 to ± 15 VDC Dual Output
10 Watts Output Power



FEATURES

- DUAL OUTPUT UP TO $\pm 1A$
- REINFORCED INSULATION FOR 250VAC WORKING VOLTAGE
- CLEARANCE AND CREEPAGE DISTANCE :8.0mm/2MOPP
- 5000VAC INPUT TO OUTPUT 2MOPP ISOLATION
- NO MINIMUM LOAD REQUIRED
- HIGH EFFICIENCY UP TO 89%
- BUILT-IN EMI CLASS A FILTER
- 2 μ A PATIENT LEAKAGE CURRENT
- SMALL SIZE: 1.25 \times 0.80 \times 0.41 INCH
- 4:1 ULTRA WIDE INPUT VOLTAGE RANGE
- FIXED SWITCHING FREQUENCY
- INPUT UNDER-VOLTAGE PROTECTION
- OUTPUT OVER-VOLTAGE PROTECTION
- OVER-CURRENT PROTECTION
- OUTPUT SHORT CIRCUIT PROTECTION
- REMOTE ON/OFF
- COMPLIANT TO RoHS 10 & REACH



CE and UKCA MARKED

SAFETY APPROVALS: ANSI/AAMI ES60601-1
EN60601-1
IEC60601-1

APPLICATIONS

- MEDICAL EQUIPMENT
- TELECOM/DATACOM
- INDUSTRY CONTROL SYSTEM
- MEASUREMENT EQUIPMENT
- SEMICONDUCTOR EQUIPMENT
- PV POWER SYSTEM
- IGBT GATE DRIVER

OPTIONS

- PIN CONNECTION
- REMOTE ON/OFF
- TRIM

GENERAL DESCRIPTIONS

The PXC-M10W series offer 10 watts of output power from a 1.25 x 0.80 x 0.41 inch package. PXC-M10W series have 4:1 wide input voltage of 9~36VDC and 18~75VDC. The PXC-M10W has features 5000VAC of isolation, short circuit protection, over-current protection and over-voltage protection. All models are particularly suited to IGBT isolated power supplies, measurement equipment, telecommunications, industrial and medical equipment applications.

Contents

Output Specifications	3
Input Specifications	4
General Specifications	5
Environmental Specifications	5
EMC Characteristics	5
Characteristic Curves	
PXC-M10-24WD05	6
PXC-M10-24WD12	8
PXC-M10-24WD15	10
PXC-M10-48WD05	12
PXC-M10-48WD12	14
PXC-M10-48WD15	16
Output Voltage Adjustment	18
Input Source Impedance	19
Output Over Current Protection	19
Output Short Circuitry Protection	20
Output Over Voltage Protection	20
Thermal Considerations	20
Remote On/Off Control	21
EMS Considerations	22
Mechanical Data	23
Recommended Pad Layout	24
Soldering Considerations	24
Packaging Information	25
Part Number Structure	25
Safety and Installation Instruction	25
MTBF and Reliability	25

Output Specifications

Parameter	Model	Min	Typ	Max	Unit
Output Voltage (Vin(nom); Full Load; Ta=25°C)	xxWD05 xxWD12 xxWD15	4.95 11.88 14.85	5 12 15	5.05 12.12 15.15	VDC
Output Regulation Line (Vin(min) to Vin(max); Full Load) Load (0% to 100% of Full Load)	All	-0.5 -1.0		+0.5 +1.0	%
Output Ripple and Noise Peak to Peak (20MHz Bandwidth) With a 10µF/25V X7R MLCC	xxWD05 xxWD12 xxWD15		30 40 40	75 100 100	mVp-p
Cross Regulation (Asymmetrical Load 25% / 100% of Full Load)	All	-5.0		+5.0	% of Vout
Voltage adjustability (see page 18) (Only for B-type Pin connection option)	xxWDxx- I	-10		+10	% of Vout
Temperature Coefficient	All	-0.02		+0.02	%/°C
Output Voltage Overshoot (Vin,min to Vin,max; Full Load; Ta=25°C)	All		0	3	% of Vout
Dynamic Load Response (Vin= Vin(nom); Ta=25°C) Load step change from 75% to 100% or 100 to 75% of Full Load Peak Deviation Setting Time (Vo < 10% peak deviation)	All All		3 250		% of Vout µs
Output Current	xxWD05 xxWD12 xxWD15	0 0 0		±1000 ±416 ±333	mA
Output Capacitance Load	xxWD05 xxWD12 xxWD15			±1440 ±250 ±180	µF
Output Over Voltage Protection (see page 20)	xxWD05 xxWD12 xxWD15	5.6 13.5 17		7.0 18.2 22.0	VDC
Output Over Current Protection (see page 19) (% of Iout rated; Hiccup mode)	All		150		% of FL
Output Short Circuit Protection (see page 20)	All				Continuous, automatic recovery

Input Specifications

Parameter	Model	Min	Typ	Max	Unit		
Operating Input Voltage	Continuous	24WDxx	9	24	36	VDC	
		48WDxx	18	48	75		
	Transient (3sec,max)	24WDxx			50		
		48WDxx			100		
Input Standby Current (Typ. value at Vin(nom); No Load)	24WD05		6		mA		
	24WD12		6				
	24WD15		6				
	48WD05		4				
	48WD12		4				
	48WD15		4				
Under Voltage Lockout Turn-on Threshold	24WDxx			9	VDC		
	48WDxx			18			
Under Voltage Lockout Turn-off Threshold	24WDxx		8		VDC		
	48WDxx		16				
Input reflected ripple current (5 to 20MHz, 12μH source impedance)	All		20		mAp-p		
Start Up Time (Vin(nom) and constant resistive load)	All				ms		
						Power up	30
						Remote ON/OFF	30
Remote ON/OFF Control (only Type B) (The Ctrl pin voltage is referenced to -Vin) Ctrl pin Low Voltage, Module ON Ctrl pin High Voltage, Module OFF	xxWDxx- P			Open	0 ~ 1.2VDC		
					2.2 ~ 12VDC		
Input Current of Remote Control Pin		-0.5		1	mA		
Remote Off State Input Current			2.5		mA		

General Specifications

Parameter	Model	Min	Typ	Max	Unit
Efficiency (Vin(nom); Full Load; Ta=25°C)	24WD05		85		%
	24WD12		89		
	24WD15		88		
	48WD05		85		
	48WD12		88		
	48WD15		88		
Isolation voltage (1 minute) Input to Output	All	5000			VAC
Isolation capacitance	All		12	17	pF
Leakage current (240VAC,60Hz)	All			2	μA
Switching Frequency	All	270	300	330	kHz
Clearance/Creepage	All	8			mm
Weight	All		14.0		g
MTBF (see page 25) MIL-HDBK-217F Ta=25°C, Full load	All		3,849 x 10 ⁶		hours
Safety Approvals	All		ANSI/AAMI ES60601-1 IEC60601-1, EN60601-1		
Case Material			Non-conductive black plastic		
Base Material	All		Non-conductive black plastic		
Potting Material	All		Silicone (UL94 V-0)		

Environmental Specifications

Parameter	Model	Min	Typ	Max	Unit
Operating Ambient Temperature Without Derating With Derating	All	-40		77	°C
		77		105	
Storage Temperature	All	-55		125	°C
Thermal Impedance (20LFM)	All		18		°C/W
Relative humidity	All	5		95	% RH
Thermal Shock	All		MIL-STD-810F		
Vibration	All		MIL-STD-810F		

EMC Characteristics

Characteristic	Standard	Condition	Level	
EMI	EN55011 EN55032 FCC Part 18	Module stand-alone	Class A	
	EN55011 EN55032 FCC Part 18	With external input filter	Class B	
ESD	EN61000-4-2	Air Contact	±8kV ±6kV	Perf. Criteria A
Radiated Immunity	EN61000-4-3		10V/m	Perf. Criteria A
Fast Transient (see page 22)	EN61000-4-4		±2kV	Perf. Criteria A
Surge (see page 22)	EN61000-4-5		±2kV	Perf. Criteria A
Conducted Immunity	EN61000-4-6		10V r.m.s	Perf. Criteria A

Characteristic Curves

All test conditions are at 25°C. The figures are for PXC-M10-24WD05

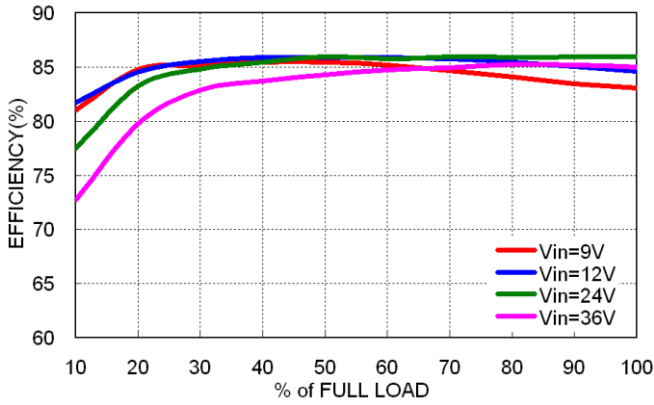

Efficiency versus Output Current

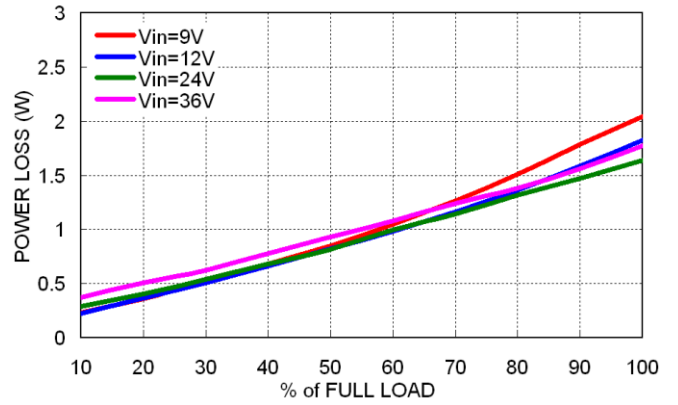

Power Dissipation versus Output Current

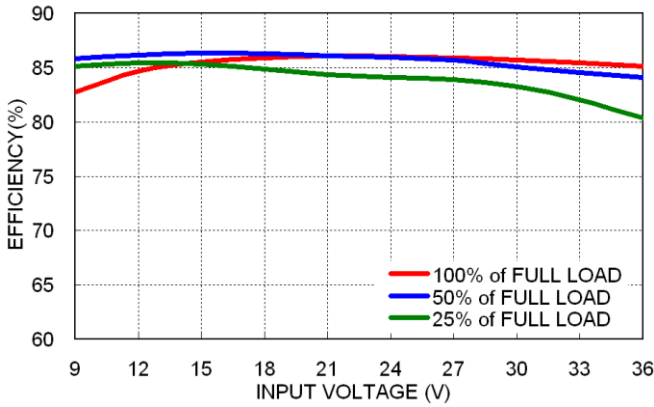

Efficiency versus Input Voltage Full Load

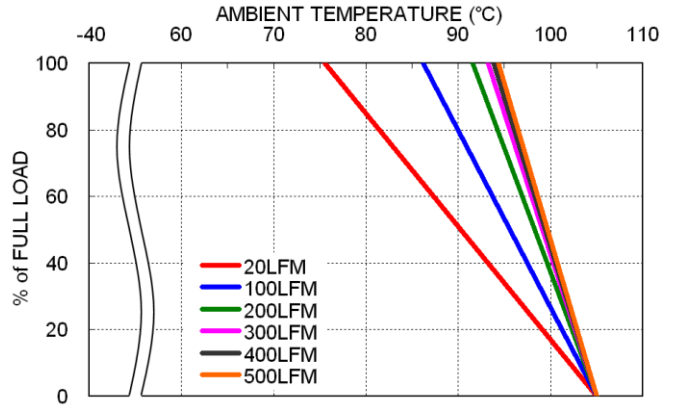

Derating Output Current versus Ambient Temperature and Airflow Vin(nom)

Characteristic Curves (Continued)

All test conditions are at 25°C. The figures are for PXC-M10-24WD05

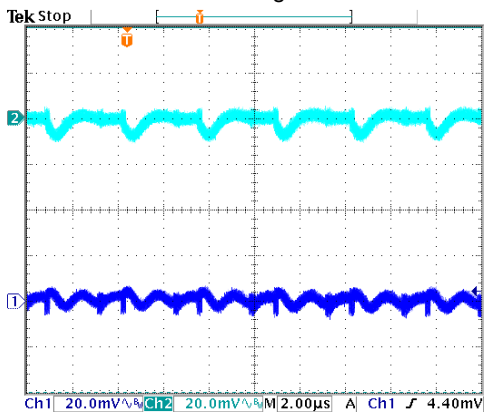

Typical Output Ripple and Noise.
Vin(nom); Full Load

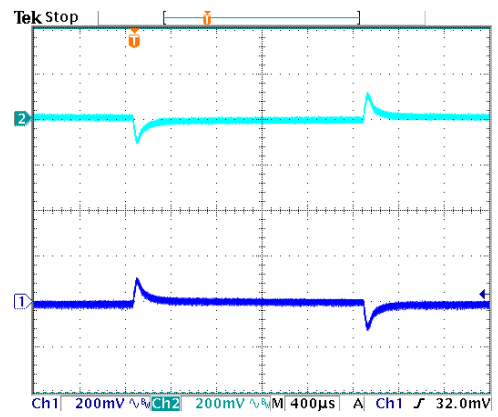

Transient Response to Dynamic Load Change from
100% to 75% to 100% of Full Load; Vin(nom)

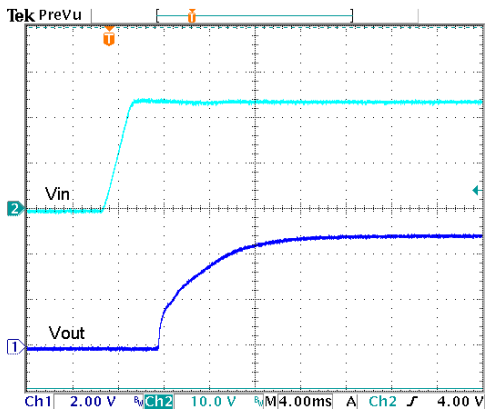

Typical Input Start-Up and Output Rise Characteristic
Vin(nom); Full Load

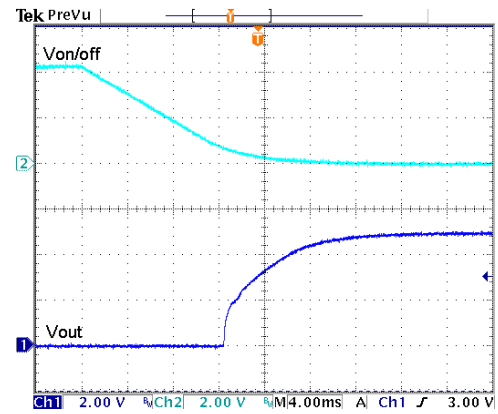

Using ON/OFF Voltage Start-Up and Output Rise Characteristic
Vin(nom); Full Load

Characteristic Curves (Continued)

All test conditions are at 25°C. The figures are for PXC-M10-24WD12

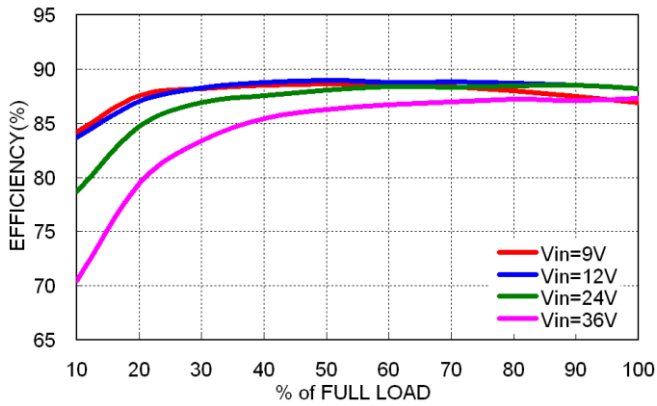

Efficiency versus Output Current

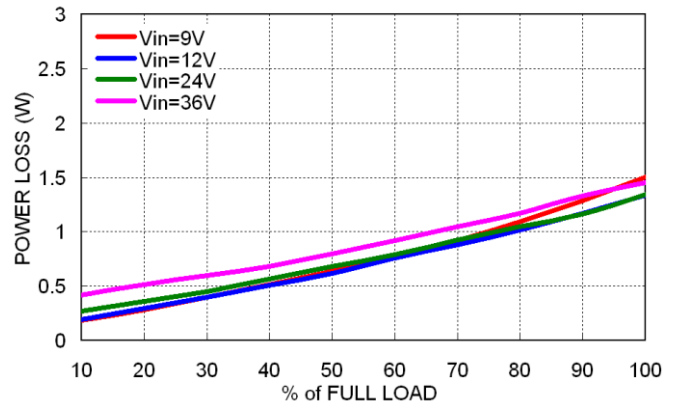

Power Dissipation versus Output Current

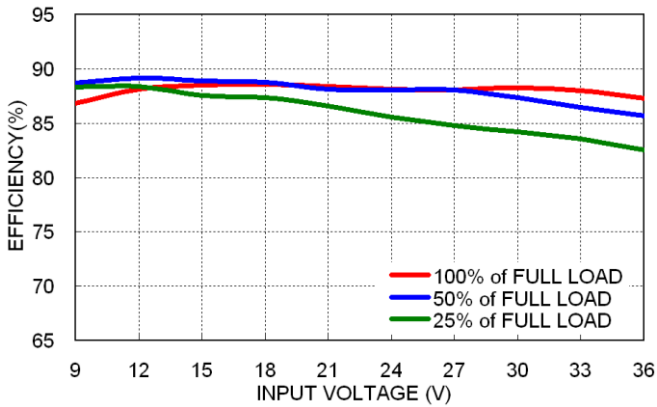

Efficiency versus Input Voltage Full Load

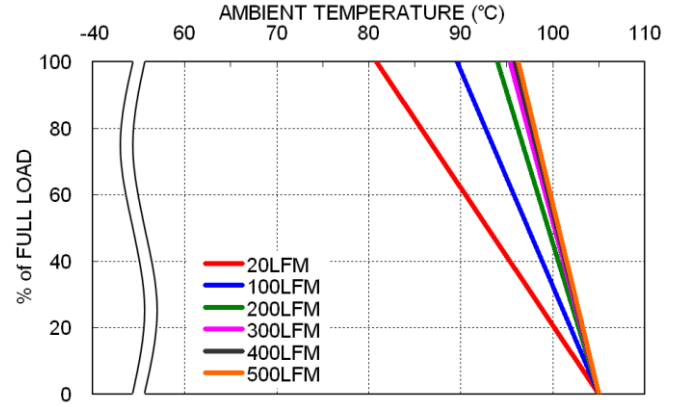

Derating Output Current versus Ambient Temperature and Airflow Vin(nom)

Characteristic Curves (Continued)

All test conditions are at 25°C. The figures are for PXC-M10-24WD12

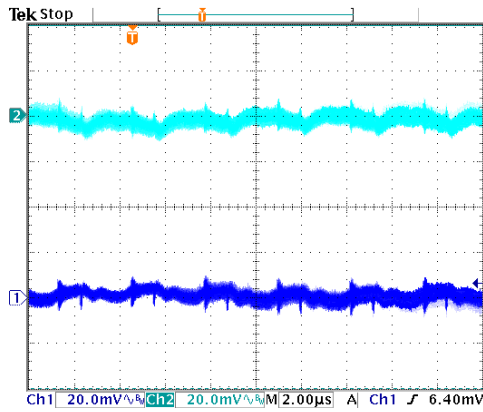

Typical Output Ripple and Noise.
Vin(nom); Full Load

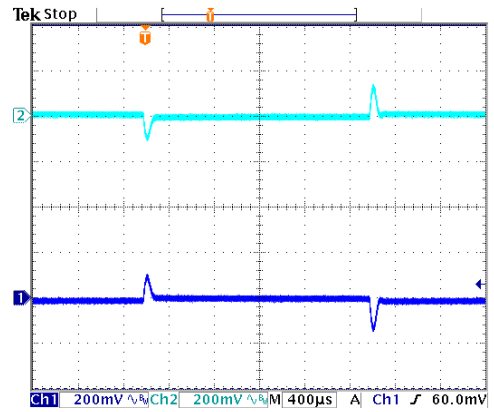

Transient Response to Dynamic Load Change from
100% to 75% to 100% of Full Load; Vin(nom)

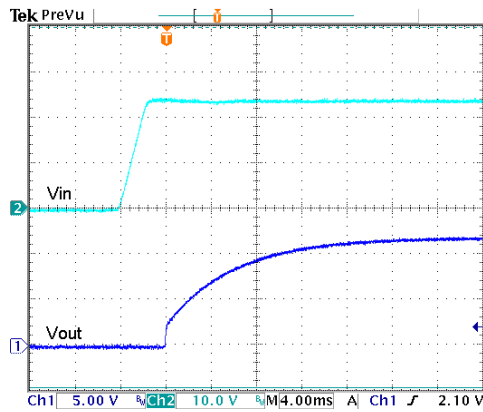

Typical Input Start-Up and Output Rise Characteristic
Vin(nom); Full Load

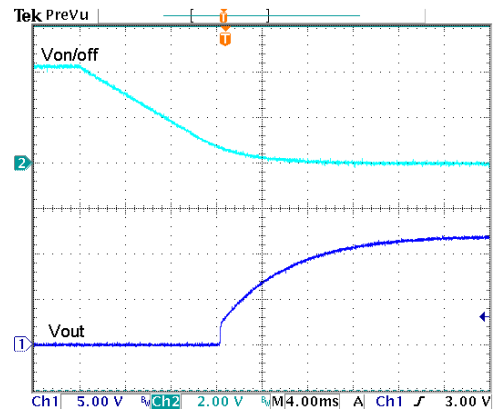

Using ON/OFF Voltage Start-Up and Output Rise Characteristic
Vin(nom); Full Load

Characteristic Curves (Continued)

All test conditions are at 25°C. The figures are for PXC-M10-24WD15

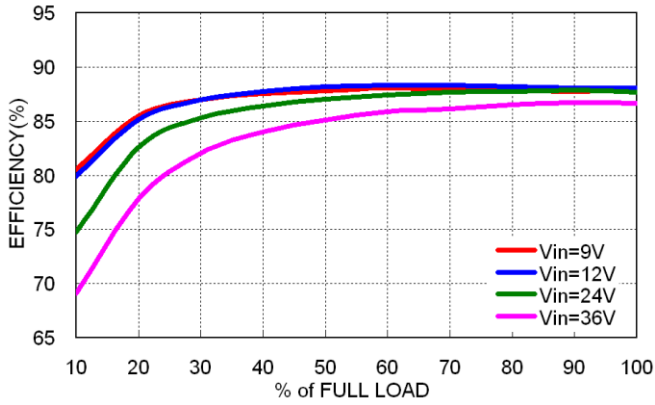

Efficiency versus Output Current

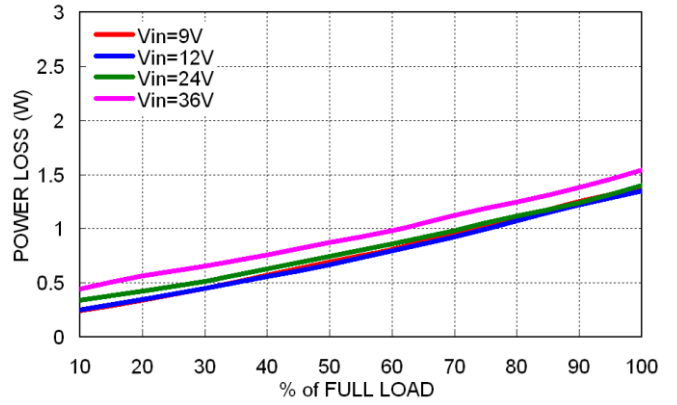

Power Dissipation versus Output Current

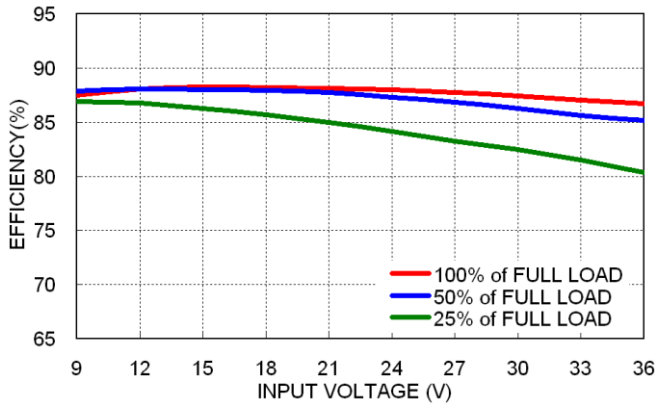

Efficiency versus Input Voltage Full Load

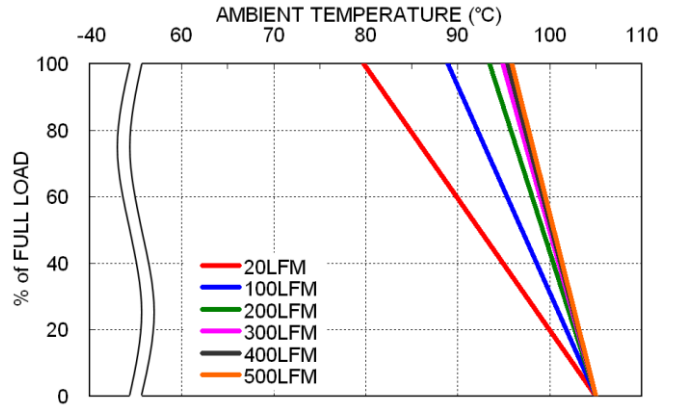

Derating Output Current versus Ambient Temperature and Airflow Vin(nom)

Characteristic Curves (Continued)

All test conditions are at 25°C. The figures are for PXC-M10-24WD15

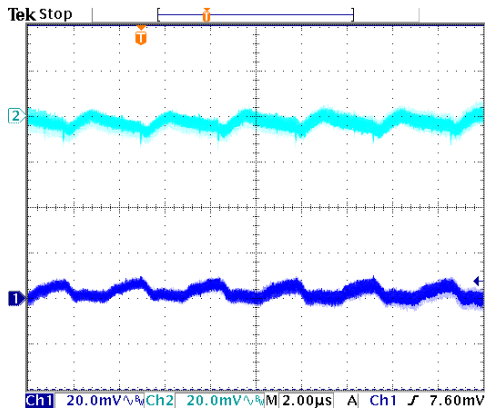

Typical Output Ripple and Noise.
Vin(nom); Full Load

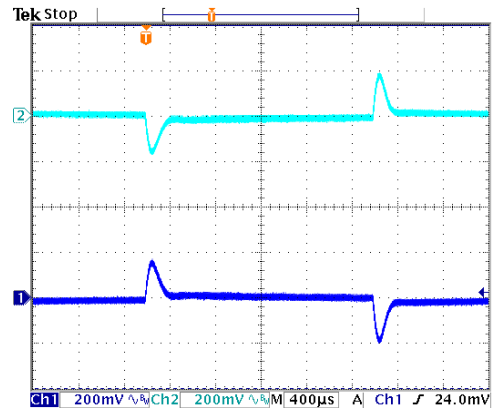

Transient Response to Dynamic Load Change from 100% to 75% to 100% of Full Load; Vin(nom)

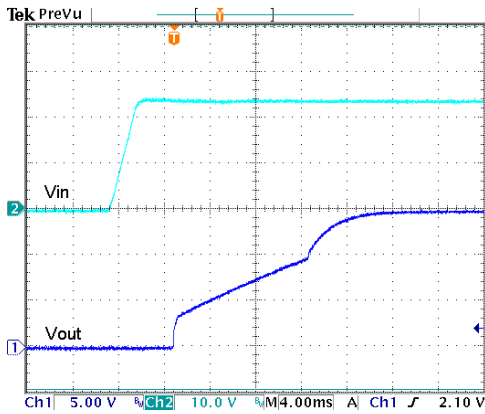

Typical Input Start-Up and Output Rise Characteristic
Vin(nom); Full Load

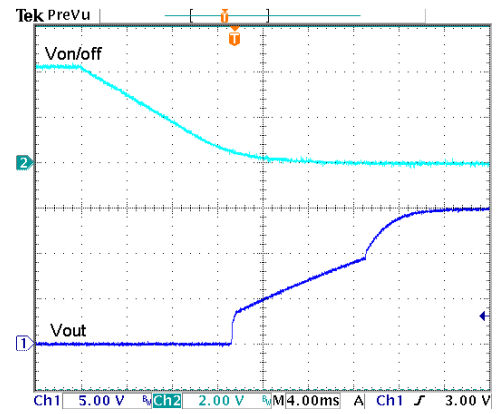

Using ON/OFF Voltage Start-Up and Output Rise Characteristic
Vin(nom); Full Load

Characteristic Curves

All test conditions are at 25°C. The figures are for PXC-M10-48WD05

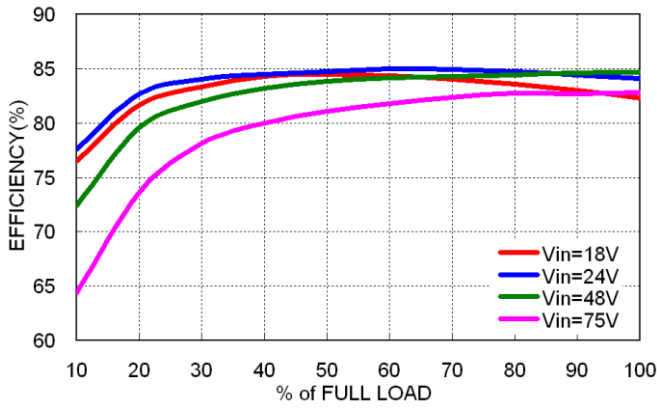

Efficiency versus Output Current

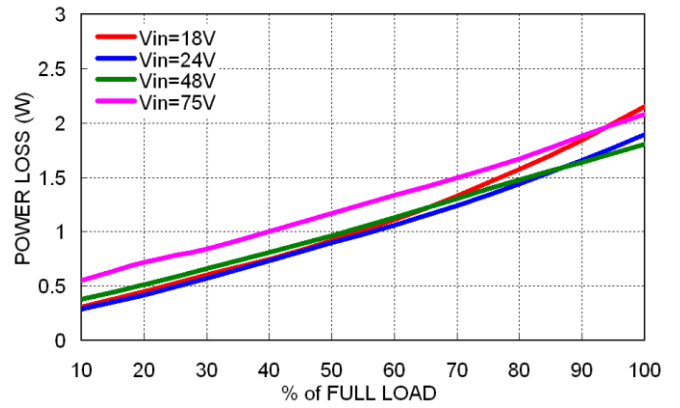

Power Dissipation versus Output Current

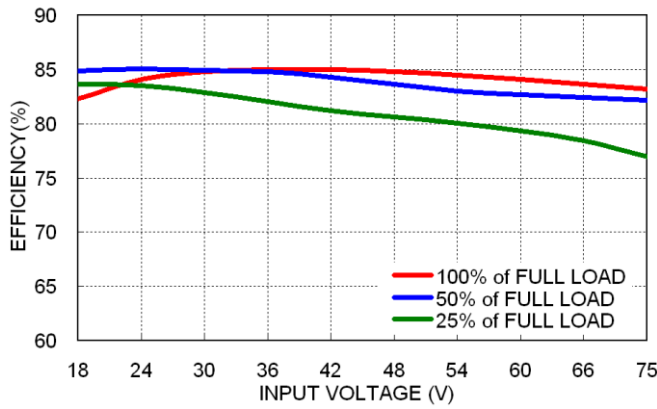

Efficiency versus Input Voltage Full Load

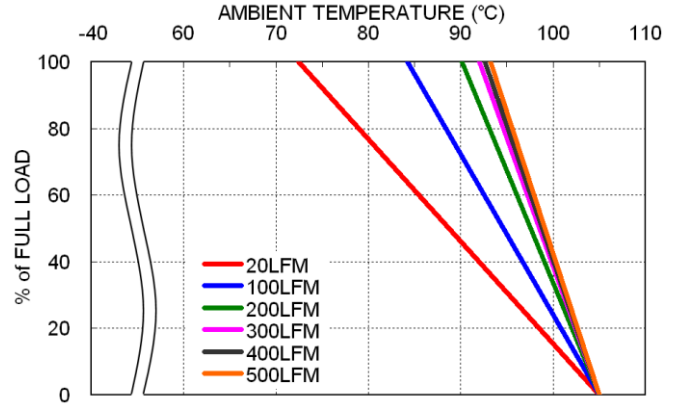

Derating Output Current versus Ambient Temperature and Airflow Vin(nom)

Characteristic Curves (Continued)

All test conditions are at 25°C. The figures are for PXC-M10-48WD05

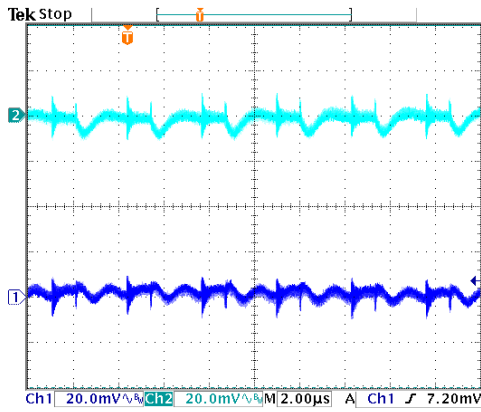

Typical Output Ripple and Noise.
Vin(nom); Full Load

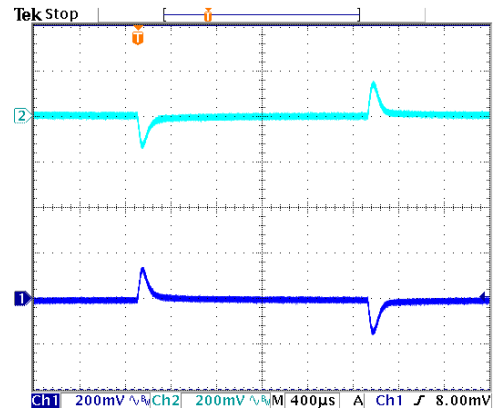

Transient Response to Dynamic Load Change from
100% to 75% to 100% of Full Load; Vin(nom)

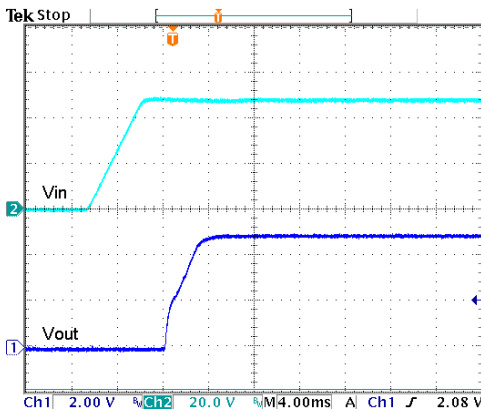

Typical Input Start-Up and Output Rise Characteristic
Vin(nom); Full Load

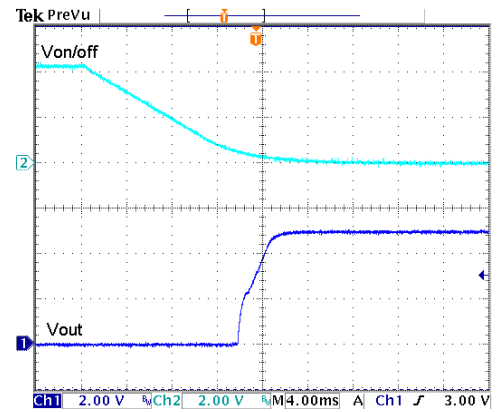

Using ON/OFF Voltage Start-Up and Output Rise Characteristic
Vin(nom); Full Load

Characteristic Curves (Continued)

All test conditions are at 25°C. The figures are for PXC-M10-48WD12

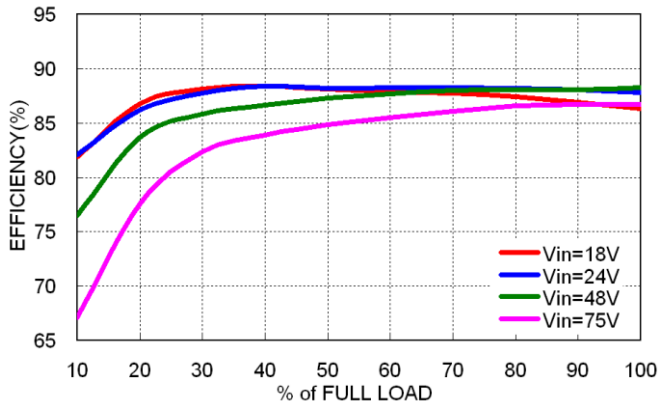

Efficiency versus Output Current

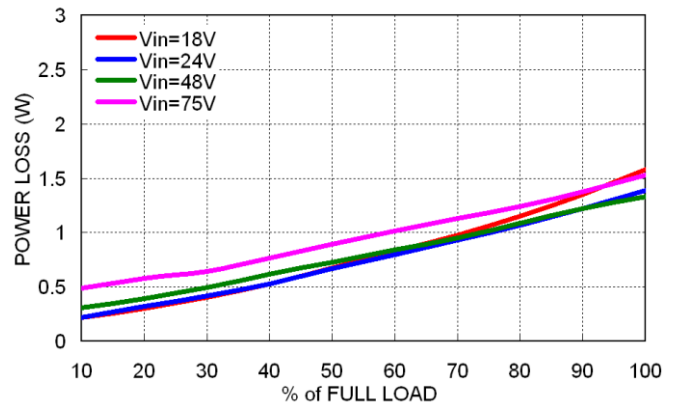

Power Dissipation versus Output Current

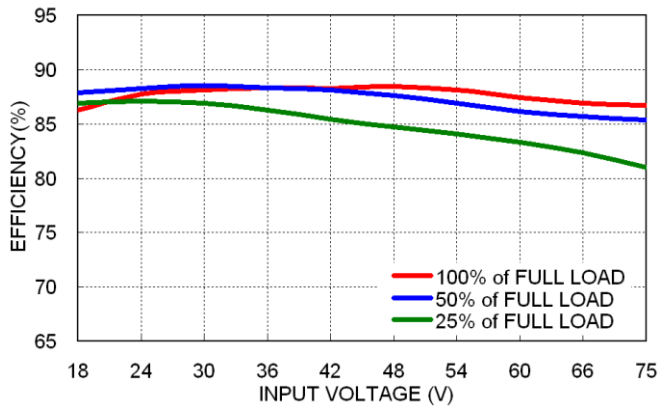

Efficiency versus Input Voltage Full Load

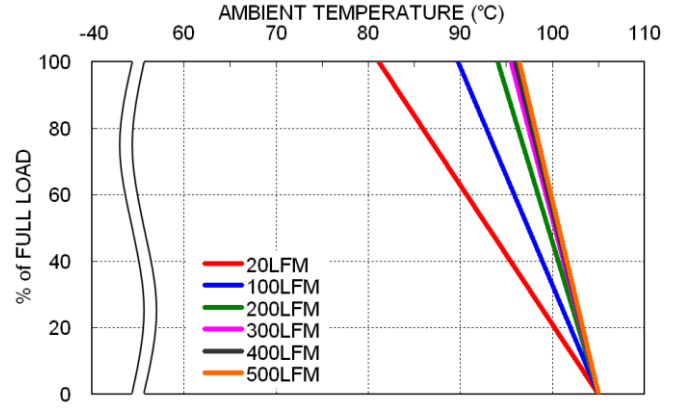

Derating Output Current versus Ambient Temperature and Airflow V_{in}(nom)

Characteristic Curves (Continued)

All test conditions are at 25°C. The figures are for PXC-M10-48WD12

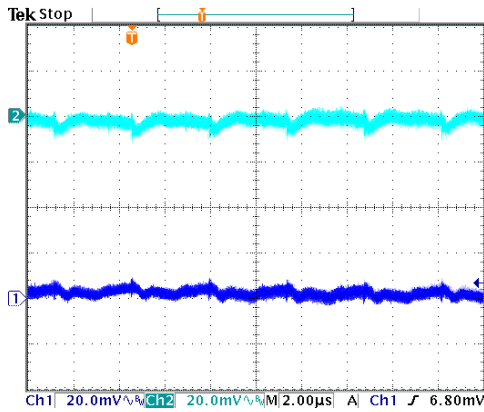

Typical Output Ripple and Noise.
Vin(nom); Full Load

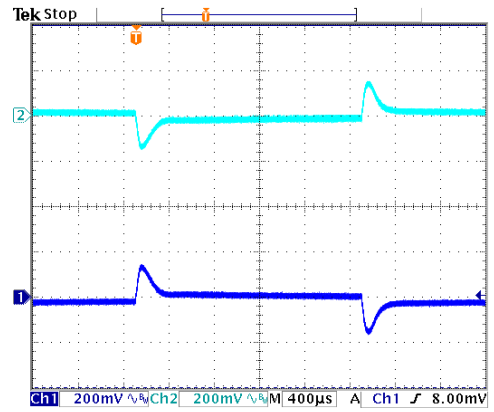

Transient Response to Dynamic Load Change from 100% to 75% to 100% of Full Load; Vin(nom)

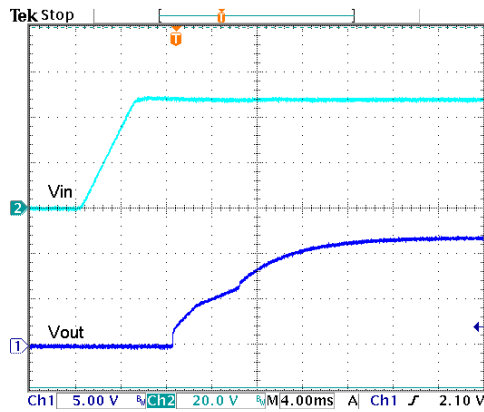

Typical Input Start-Up and Output Rise Characteristic
Vin(nom); Full Load

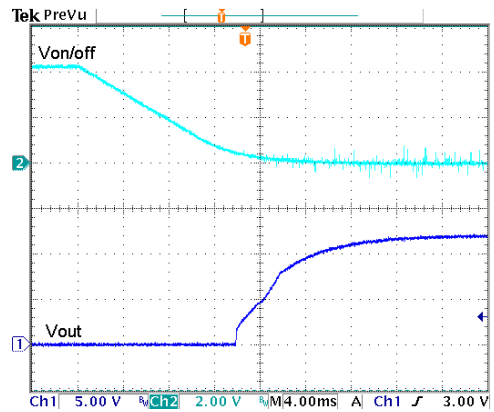

Using ON/OFF Voltage Start-Up and Output Rise Characteristic
Vin(nom); Full Load

Characteristic Curves (Continued)

All test conditions are at 25°C. The figures are for PXC-M10-48WD15

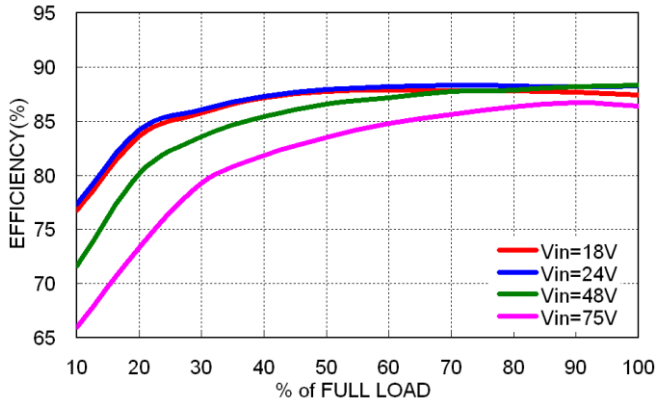

Efficiency versus Output Current

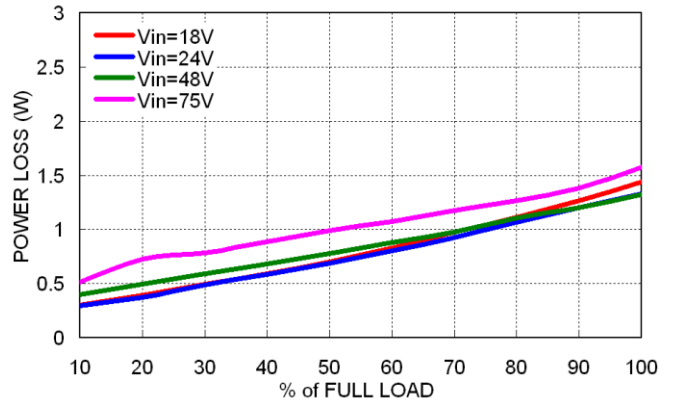

Power Dissipation versus Output Current

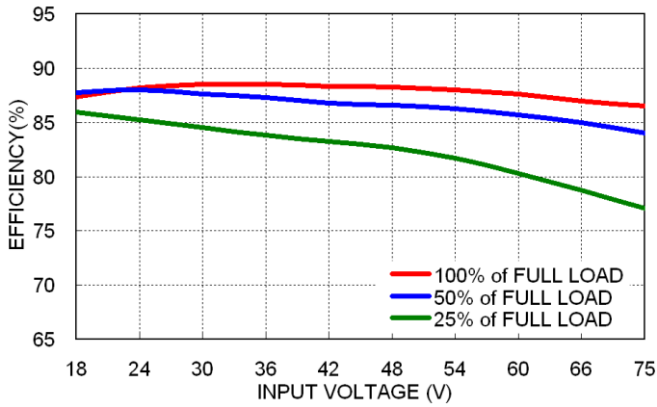

Efficiency versus Input Voltage Full Load

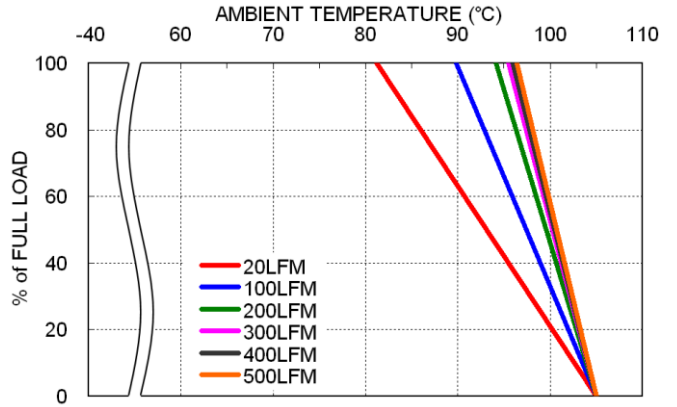

Derating Output Current versus Ambient Temperature and Airflow Vin(nom)

Characteristic Curves (Continued)

All test conditions are at 25°C. The figures are for PXC-M10-48WD15

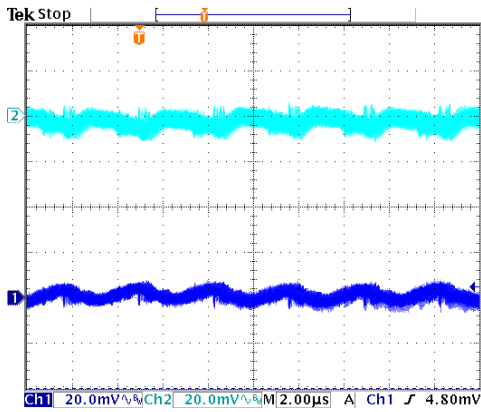

Typical Output Ripple and Noise.
Vin(nom); Full Load

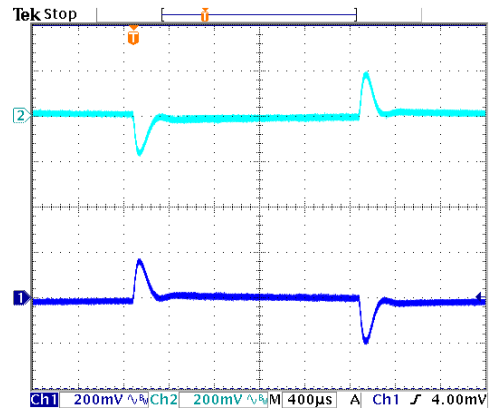

Transient Response to Dynamic Load Change from
100% to 75% to 100% of Full Load; Vin(nom)

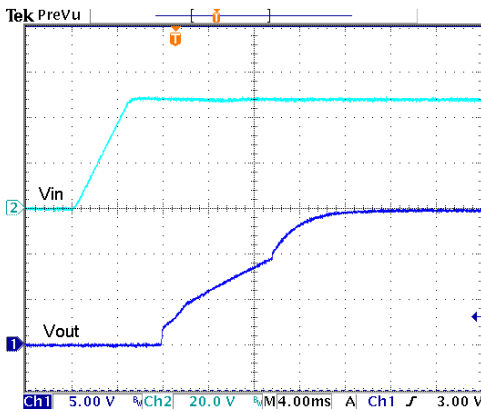

Typical Input Start-Up and Output Rise Characteristic
Vin(nom); Full Load

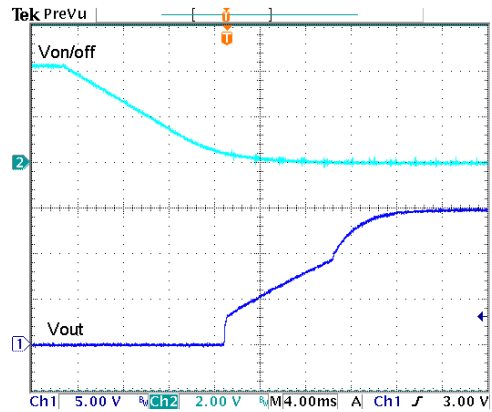

Using ON/OFF Voltage Start-Up and Output Rise Characteristic
Vin(nom); Full Load

Output Voltage Adjustment

Output voltage adjustment is an optional function for PXC-M10-xxWDxx-xT.

It allows the user to increase or decrease the output voltage of the module. This is accomplished by connecting an external resistor between the TRIM pin and either the +Vout or -Vout pins. With an external resistor between the TRIM and -OUTPUT pin, the output voltage increases. With an external resistor between the TRIM and +OUTPUT pin, the output voltage decreases. The external TRIM resistor needs to be at least 1/16W of rated power.

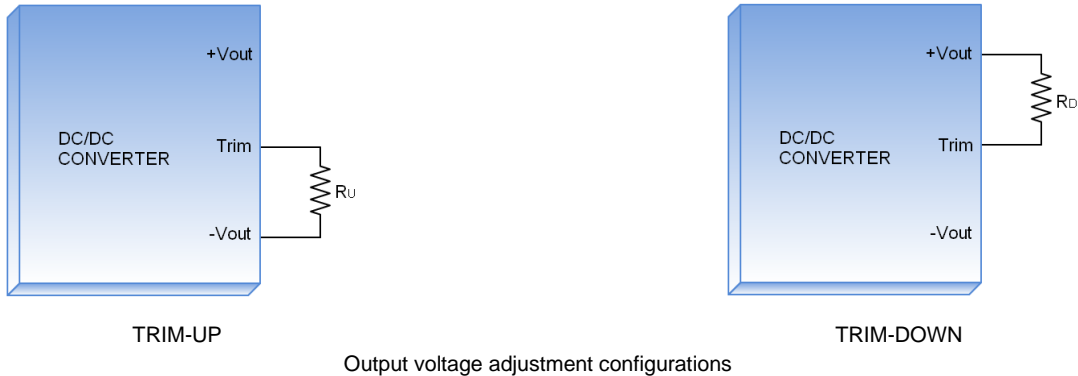

TRIM TABLE

xxWD05-xT		TRIM-UP									
Trim-Up (%)		1	2	3	4	5	6	7	8	9	10
Vout (V)		±5.047	±5.097	±5.147	±5.196	±5.246	±5.296	±5.346	±5.396	±5.446	±5.496
RU (kΩ)		71.84	34.42	21.95	15.71	11.97	9.47	7.69	6.36	5.32	4.48

TRIM-DOWN											
Trim-Down (%)		1	2	3	4	5	6	7	8	9	10
Vout (V)		±4.947	±4.897	±4.847	±4.797	±4.747	±4.697	±4.647	±4.597	±4.547	±4.497
RD (kΩ)		219.16	106.58	69.05	50.29	39.03	31.53	26.17	22.14	19.02	16.52

xxWD12-xT		TRIM-UP									
Trim-Up (%)		1	2	3	4	5	6	7	8	9	10
Vout (V)		±12.113	±12.233	±12.352	±12.472	±12.592	±12.712	±12.832	±12.952	±13.072	±13.192
RU (kΩ)		568.20	277.60	180.73	132.30	103.24	83.87	70.03	59.65	51.58	45.12

TRIM-DOWN											
Trim-Down (%)		1	2	3	4	5	6	7	8	9	10
Vout (V)		±11.873	±11.753	±11.633	±11.513	±11.393	±11.273	±11.153	±11.033	±10.913	±10.793
RD (kΩ)		4949.80	2440.40	1603.93	1185.70	934.76	767.47	647.97	558.35	488.64	432.88

xxWD15-xT		TRIM-UP									
Trim-Up (%)		1	2	3	4	5	6	7	8	9	10
Vout (V)		±15.131	±15.281	±15.43	±15.58	±15.73	±15.88	±16.03	±16.179	±16.329	±16.479
RU (kΩ)		236.25	111.62	70.08	49.31	36.85	28.54	22.61	18.16	14.69	11.92

TRIM-DOWN											
Trim-Down (%)		1	2	3	4	5	6	7	8	9	10
Vout (V)		±14.831	±14.681	±14.532	±14.382	±14.232	±14.082	±13.932	±13.782	±13.633	±13.483
RD (kΩ)		2707.75	1332.38	873.92	644.69	507.15	415.46	349.96	300.84	262.64	232.08

Input Source Impedance

The power module should be connected to a low impedance input source. Highly inductive source impedance can affect the stability of the power module. Install choke (L_{SIM}) to simulate the impedance of power source. External input capacitors C_{FILTER} serve primarily as energy-storage elements, minimizing line voltage variations caused by transient IR drops in conductors from backplane to the DC/DC. The capacitor must as close as possible to the input terminals of the power module for lower impedance. The input reflected-ripple current measurement configuration is shown below:

Input reflected-ripple current measurement setup

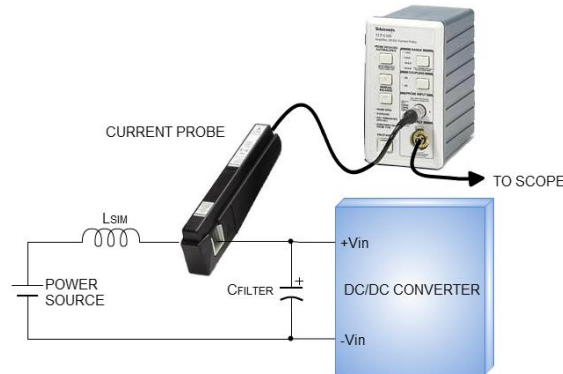

PXC-M10-24WDxx

Component	Value	Voltage	Reference
L _{SIM}	12μH	----	Inductor
C _{FILTER}	47μF	100V	Nippon chemi-con KY-series

PXC-M10-48WDxx

Component	Value	Voltage	Reference
L _{SIM}	12μH	----	Inductor
C _{FILTER}	47μF	100V	Nippon chemi-con KY-series

Output Over Current Protection

When excessive output currents occur in the system, circuit protection is required on all power supplies. Normally, overload current is maintained at approximately 150 percent of rated current for PXC-M10W SERIES.

Hiccup-mode is a method of operation in a power supply whose purpose is to protect the power supply from being damaged during an over-current fault condition. It also enables the power supply to restart when the fault is removed. There are other ways of protecting the power supply when it is over-loaded, such as the maximum current limiting or current fold-back methods.

One of the problems resulting from over current is that excessive heat may be generated in power devices; especially MOSFET and Schottky diodes and the temperature of those devices may exceed their specified limits. A protection mechanism has to be used to prevent those power devices from being damaged.

The operation of hiccup is as follows. When the current sense circuit sees an over-current event, the controller shuts off the power supply for a given time and then tries to start up the power supply again. If the over-load condition has been removed, the power supply will start up and operate normally; otherwise, the controller will see another over-current event and shut off the power supply again, repeating the previous cycle. Hiccup operation has none of the drawbacks of the other two protection methods, although its circuit is more complicated because it requires a timing circuit. The excess heat due to overload lasts for only a short duration in the hiccup cycle, hence the junction temperature of the power devices is much lower.

The hiccup operation can be done in various ways. For example, one can start hiccup operation any time an over-current event is detected; or prohibit hiccup during a designated start-up interval (usually a few milliseconds). The reason for the latter operation is that during start-up, the power supply needs to provide extra current to charge up the output capacitor. Thus the current demand during start-up is usually larger than during normal operation and it is easier for an over-current event to occur. If the power supply starts to hiccup once there is an over-current, it might never start up successfully. Hiccup mode protection will give the best protection for a power supply against over current situations, since it will limit the average current to the load at a low level, so reducing power dissipation and case temperature in the power devices.

Output Short Circuitry Protection

Continuous and auto-recovery mode.

During short circuit, converter still shut down. The average current during this condition will be very low and the device can be safety in this condition.

Output Over Voltage Protection

The output over-voltage protection consists of circuitry that internally clamps the output voltage. If a more accurate output over-voltage protection scheme is required then this should be implemented externally via use of the remote on/off pin.

Thermal Considerations

The power module operates in a variety of thermal environments; however, sufficient cooling should be provided to help ensure reliable operation of the unit. Heat is removed by conduction, convection, and radiation to the surrounding environment. Proper cooling can be verified by measuring the point as shown in the figure below. The temperature at this location should not exceed 105°C. When operating, adequate cooling must be provided to maintain the test point temperature at or below 105°C. Although the maximum point temperature of the power modules is 105°C, limiting this temperature to a lower value enhances the reliability.

TEMPERATURE MEASUREMENT POINT

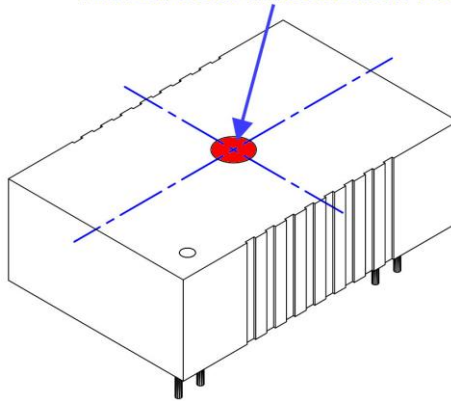

Remote On/Off Control

Only for B-type pin connection option with suffix -P,. Ex.: PXC-M10-24WD05-P

The module is ON during logic Low and turns OFF during logic High. The Ctrl pin is an open collector/drain logic input signal that is referenced to (-)Vin. If not using the remote on/off feature, the Ctrl and (-)Vin pins should be connected together (shorted) or apply 0-1.2V between these two pins for the module to be ON.

Remote ON/OFF Implementation

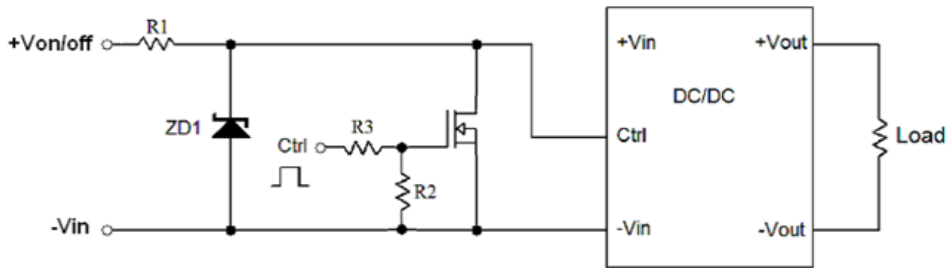

	QTY	REFERENCE	DESCRIPTION	MFG	PART NUMBER
MOS	1	Q1	100V,9.4A, 0.21Ω	IR	IRFR120N
Resistor	1	R1	100kΩ,0805		
	1	R2	10kΩ,0805		
	1	R3	100Ω,0805		
Zener	1	ZD1	9.1V,SOD-523	ROHM	EDZ9.1B

Below are test results for this recommended circuit.

MOSFET V _{GS} Voltage	Von/off Voltage	Input current of Ctrl pin (based on the actual test)	DC/DC MODULE
0V (LOW)	OPEN	0μA	ON
0V (LOW)	0V	-6.6μA	ON
0V (LOW)	2V	3.6μA	ON
0V (LOW)	5V	18μA	OFF
0V (LOW)	10V	42μA	OFF
0V (LOW)	12V	52μA	OFF
5V (HIGH)	OPEN	-13.8μA	ON
5V (HIGH)	0V	-13.8μA	ON
5V (HIGH)	2V	-13.8μA	ON
5V (HIGH)	5V	-13.8μA	ON
5V (HIGH)	10V	-13.8μA	ON
5V (HIGH)	12V	-13.8μA	ON

Maximum voltage on the drain of the FET is the voltage of ZD1 (9.1 Vdc).

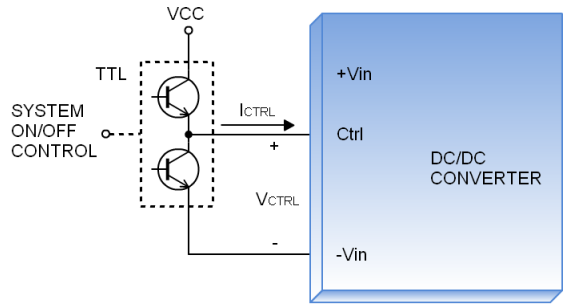

Level Control Using TTL Output

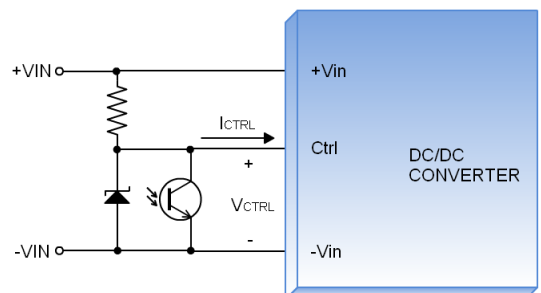

Level Control Using Line Voltage

EMS Considerations

The PXC-M10W series can meet Fast Transient EN61000-4-4 and Surge EN61000-4-5 performance criteria A with external components connected to the input terminals of the module. Please see the following schematic:

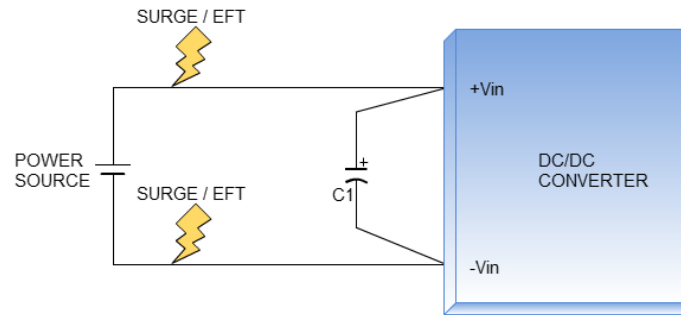

Surge / Fast Transient

PXC-M10-24WDxx

Component	Value	Voltage	Reference
C1	470 μ F	50V	Nippon chemi-con KY-series

PXC-M10-48WDxx

Component	Value	Voltage	Reference
C1	330 μ F	100V	Nippon chemi-con KY-series

Mechanical Data

PXC-M10-xxWDxx A Type

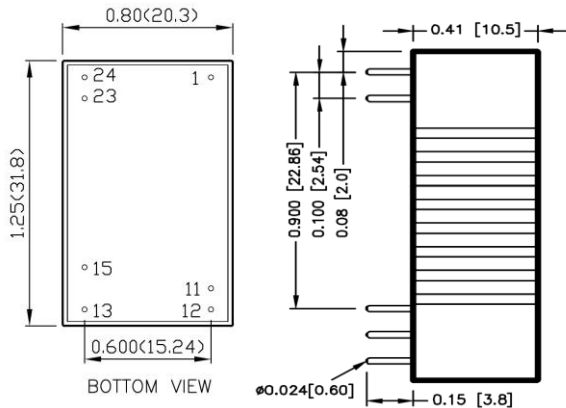

PIN CONNECTION

PIN	FUNCTION
1	+ Vin
11	Com
12	No pin
13	-Vout
15	+Vout
23	- Vin
24	- Vin

1. All dimensions in Inch (mm)
2. Tolerance: X.XX±0.02 (X.X±0.5)
X.XXX±0.01 (X.XX±0.25)
3. Pin pitch tolerance ±0.01 (0.25)
4. Pin dimension tolerance ±0.004 (0.1)

PXC-M10-xxWDxx B Type

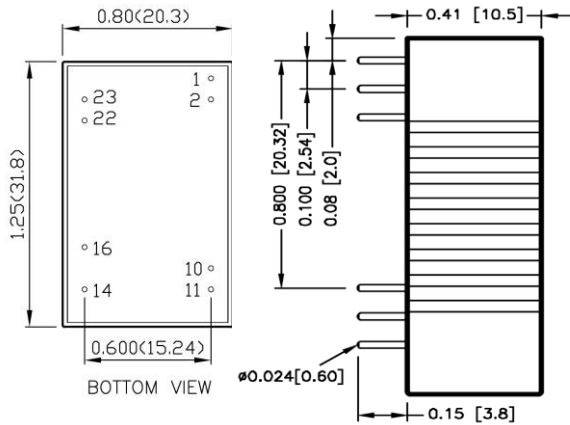

PIN CONNECTION

PIN	FUNCTION
1	Ctrl (Option) / No pin
2	- Vin
10	Trim (Option) / No pin
11	-Vout
14	+Vout
16	Com
22	+Vin
23	+Vin

*If no Ctrl or Trim option, there is no pin on the corresponding pin number.

1. All dimensions in Inch (mm)
2. Tolerance: X.XX±0.02 (X.X±0.5)
X.XXX±0.01 (X.XX±0.25)
3. Pin pitch tolerance ±0.01 (0.25)
4. Pin dimension tolerance ±0.004 (0.1)

Recommended Pad Layout

PXC-M10-xxWDxx A Type

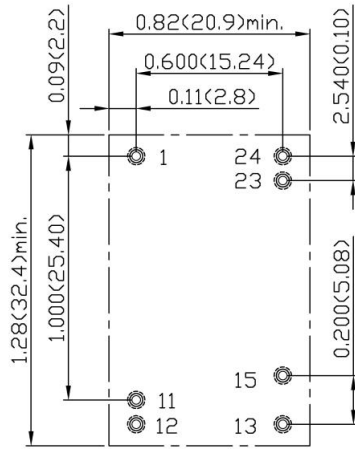

PXC-M10-xxWDxx B Type

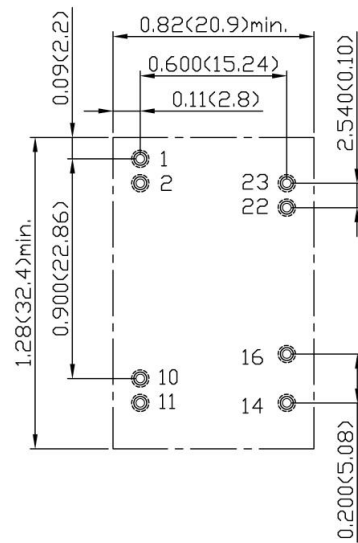

1. All dimensions in Inch (mm)
Tolerance: X.XX±0.02 (X.X±0.5)
X.XXX±0.01 (X.XX±0.25)
2. Pin pitch tolerance ±0.01 (0.25)
3. Pin dimension tolerance ±0.004 (0.1)

Soldering Considerations

Lead free wave solder profile

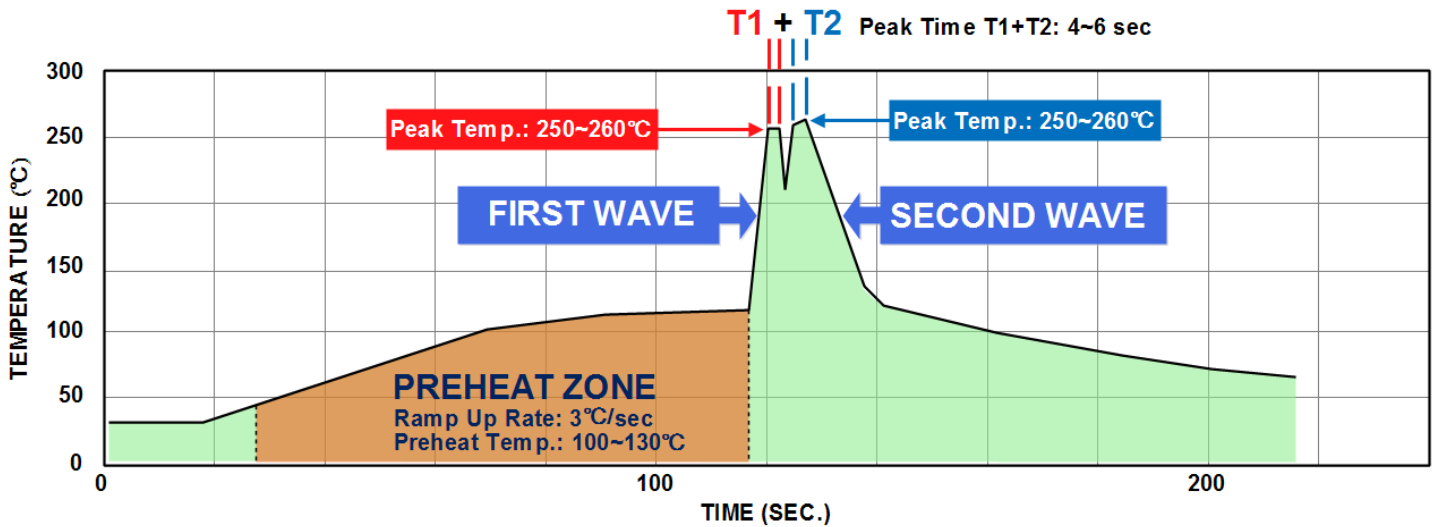

Reference Solder : Sn-Ag-Cu ; Sn-Cu

Hand Soldering (Reference) :

Soldering iron : Power 150W

Soldering Time : 3-6 sec

Temp : 410-430°C

Packaging Information

Tube

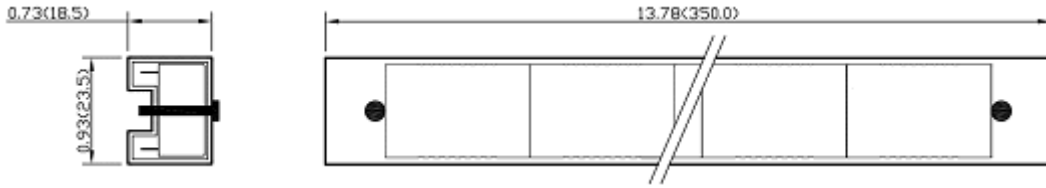

10pcs converters in a Tube
All dimensions in inches (mm)

Part Number Structure

PXC-M10	-	48W	D	05	-	A	-	P	T
Series Name		Input Voltage (VDC)	Output Quantity	Output Voltage (VDC)		Pin Connection Option		Remote On/Off Option	Trim Option
		24: 9~36 48: 18~75	S: Single	3P3: 3.3 05: 5 12: 12 15: 15 24: 24		A: A type □: B type		□: No On/Off control P: Remote On/Off (Only for B type Pin connection)	□: No Trim T: Trim (Only for B type Pin connection)
			D: Dual	05: ±5 12: ±12 15: ±15					

Model Number	Input Range VDC	Output Voltage VDC	Output Current @ Full Load mA	Input Current @ No Load mA	Efficiency %	Maximum Capacitor Load μF
PXC-M10-24WD05A/□	9 ~ 36	±5	±1000	6	85	±1440
PXC-M10-24WD12A/□		±12	±416	6	89	±250
PXC-M10-24WD15A/□		±15	±333	6	88	±180
PXC-M10-48WD05A/□	18 ~ 75	±5	±1000	4	85	±1440
PXC-M10-48WD12A/□		±12	±416	4	88	±250
PXC-M10-48WD15A/□		±15	±333	4	88	±180

Safety and Installation Instructions

Fusing Consideration

Caution: This power module is not internally fused. An input line fuse must always be used.

This encapsulated power module can be used in a wide variety of applications, ranging from simple stand-alone operation to an integrated part of sophisticated power architecture. For maximum flexibility, internal fusing is not included; however, to achieve maximum safety and system protection, always use an input line fuse. See suggested values below:

Model	Fuse Rating (A)	Fuse Type
PXC-M10-24WDxx	2	Slow-Blow
PXC-M10-48WDxx	1	Slow-Blow

Based on the information provided in this data sheet on inrush energy and maximum dc input current at low Vin.

MTBF and Reliability

The MTBF has been calculated using:

MIL-HDBK 217F NOTICE2 FULL LOAD, Operating Temperature at 25°C. The resulting figure for MTBF is 3.849×10⁶ hours.