

**TDK  $\mu$ POL™ EVALUATION BOARD**

**μPOL**

**TDK** [www.tdk.com/POL](http://www.tdk.com/POL)

# EV1606-0600-A EVALUATION BOARD USER GUIDE



Patent Protected: US 9,729,059 B1; US 10,193,442 B2  
 Copyright© 2018–20 TDK Corporation. All rights reserved.  
 All registered trademarks and trademarks are the property of their respective owners.  
 Data and specifications subject to change without notice.



## Introduction

This user guide describes the evaluation board provided for the FS1606-0600  $\mu$ POL™ product.

The board generates an output voltage ( $V_{OUT}$ ) of 1.8V\* for loads of 0–6A from an input voltage ( $PV_{IN}$ ) of 12V.

## Specifications

- Input voltage ( $PV_{IN}$ ) = +12V
- Output voltage ( $V_{OUT}$ ) = +1.8V
- Output load ( $I_O$ ) = 0–6A
- Switching frequency ( $F_{SW}$ ) = 2MHz
- Output capacitance ( $C_O$ ) = 3x22 $\mu$ F (MLCC)
- Input capacitance ( $C_{IN}$ ) = 2x22 $\mu$ F (MLCC)
- Dimensions (width x length x thickness) = 63 x 84 x 1.5mm

## Connections

Name	Identifier	Description
$PV_{IN}$	J1	Input voltage (+12V)
Gnd	J2	Ground for input voltage
$V_{OUT}$	J8	Output voltage (+1.8V)
Gnd	J7	Ground for output voltage
$V_{CC}$	TP2	Internal supply ( $V_{CC}$ ) – output of an LDO regulator
Gnd	TP3	Ground for internal supply
En	TP11	Enable
PG	TP12	Power Good

The board is configured for a single input supply. An internal low drop-out regulator generates the internal supply ( $V_{CC}$ ) from  $PV_{IN}$ . The Enable (En) input is connected to  $PV_{IN}$  through a resistor divider, so that no Enable signal is needed.

## Operation

To use the evaluation board:

1. Connect a well-regulated +12V input supply to  $PV_{IN}$  (J1) and Gnd (J2).
2. Connect a load of 0–6A to  $V_{OUT}$  (J8) and Gnd (J7).

**\*NOTE – Output Voltages from 0.6V to 2.5V can be obtained by changing the values of Resistor Divider Components. Refer Page 5.**

## Description

The evaluation board consists of a 4-layer PCB made from FR4 glass-reinforced epoxy laminate material. All layers use 2oz copper (equating to a thickness of 0.0694mm). The major power components, including the FS1606, are mounted on the top side of the board.

Part reference	Quantity	Type	Description
FS1606 $\mu$ POL	1	–	Main IC
C8	1	680pF	0805, 50V, COG
C9	1	2.2 $\mu$ F	0402, 10V, X7S
C10, C21	2	22 $\mu$ F	0805, 16V, X5R
C12	1	0.1 $\mu$ F	0402, 16V, X7R
C13	1	68 $\mu$ F	25V
C14, C15, C16	3	22 $\mu$ F	0805, 6.3V, X5R
C26	1	1 $\mu$ F	0603, 25V, X5R
J1	1	Red	Banana connector
J2, J7	2	Black	Banana connector
J8	1	Green	Banana connector
J10, J11	2	–	3-pin header
R1	1	2.7 $\Omega$	10%, 1/8W, 0805 case size
R3, R7	2	49.9k $\Omega$	10%, 1/8W, 0805 case size
R4	1	4.12k $\Omega$	10%, 1/8W, 0805 case size
R5	1	2.1k $\Omega$	10%, 1/8W, 0805 case size
R6	1	12.7k $\Omega$	10%, 1/8W, 0805 case size
R9, R13	2	0 $\Omega$	0805 case size
R11, R17	2	0 $\Omega$	0402 case size
R18, R19	2	4.99k $\Omega$	0402 case size
TP1-TP12, SW/NC15, VBUS, VEXTBUS, SCL, SDA	17	–	Test points

Figure 1 shows the layout of the board and Figure 2 shows a schematic of the electrical circuit.

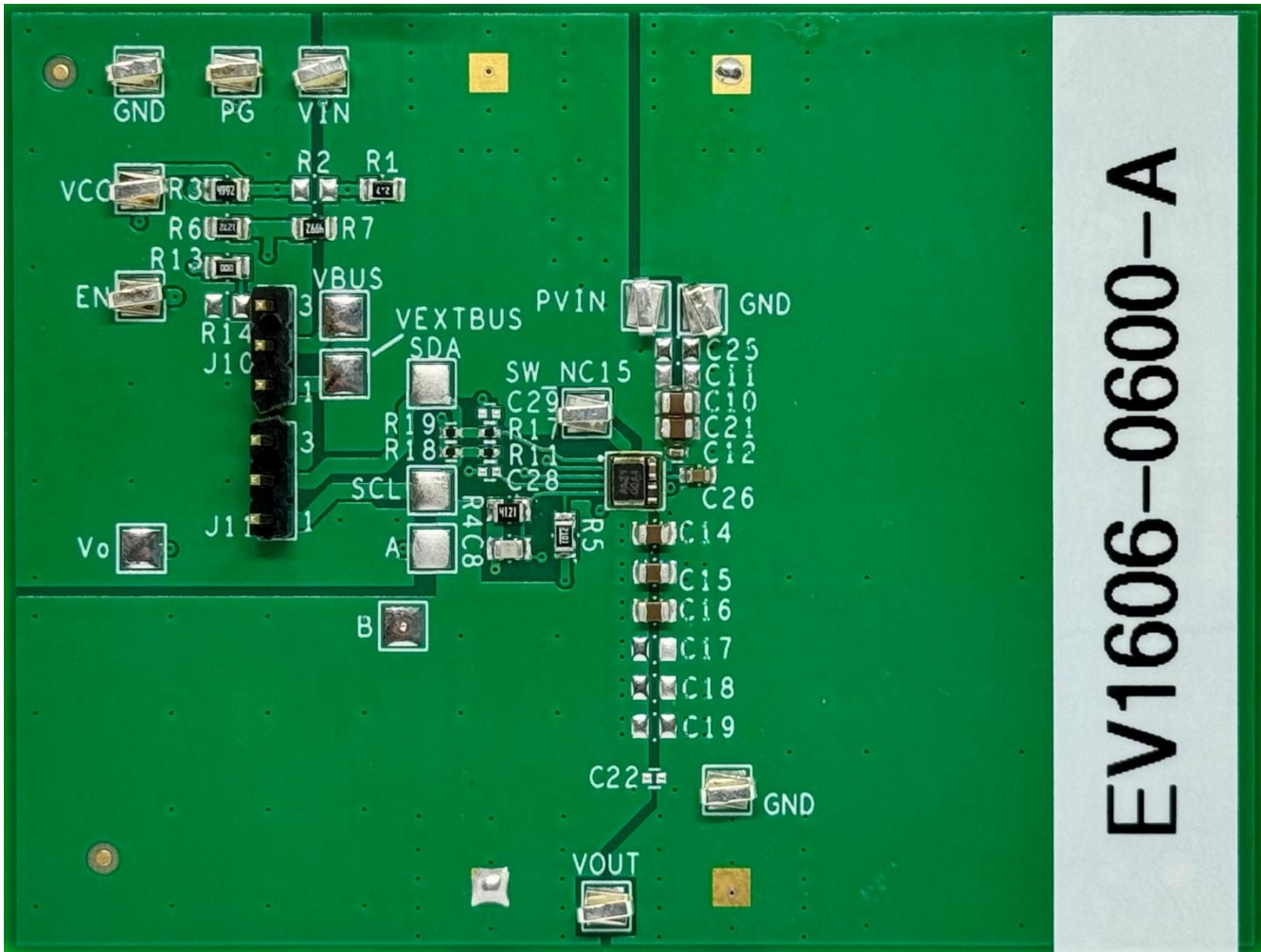


Figure 1 Board layout

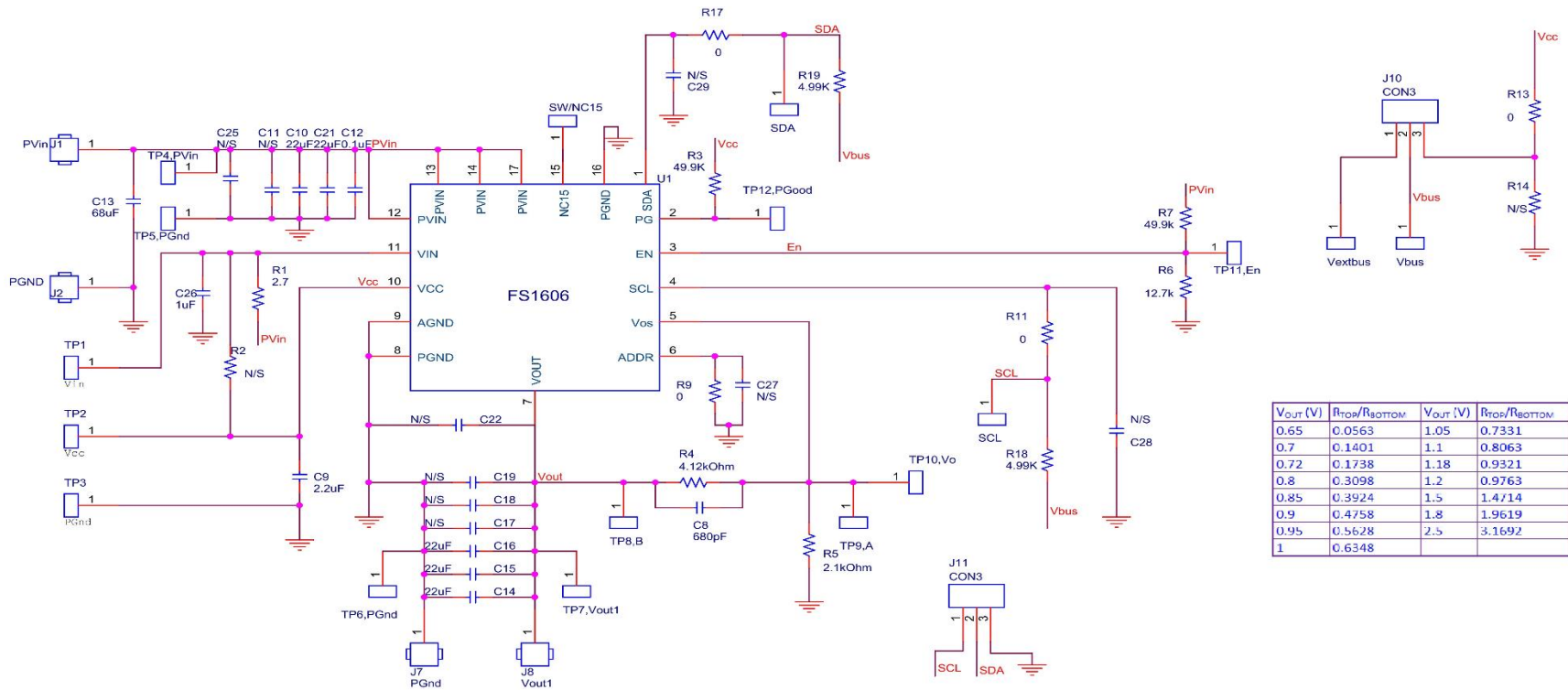
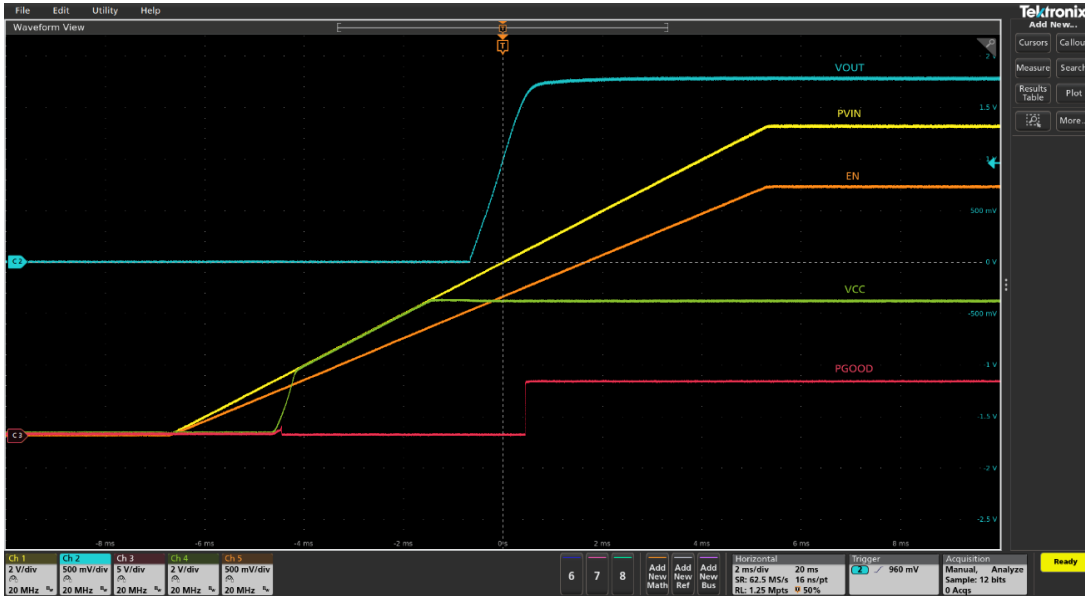


Figure 2 Schematic\*

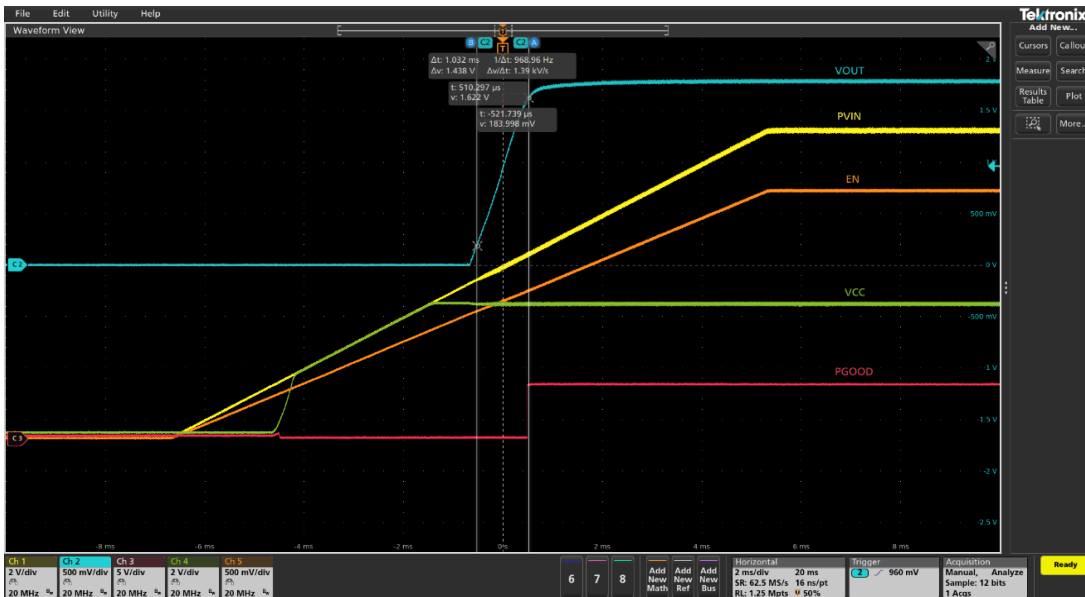
\*NOTE – Modify R5 (R<sub>BOTTOM</sub>) for different V<sub>OUT</sub> as per the included table. R4 (R<sub>TOP</sub>) = 4.12 kΩ, C8 = 680pF is recommended. For V<sub>OUT</sub> = 0.6V; R4 = 0Ω, C8 = DNP. R9 = 0Ω for V<sub>OUT</sub> ≥ 1.5V and R9 = 6.34 kΩ for V<sub>OUT</sub> < 1.5V.

## Typical performance

Figure 3 to Figure 17 show typical operating waveforms for the evaluation board, while Figure 18 shows a thermal image of the board in operation. In all cases, the board is operating at room temperature with no airflow;  $PV_{IN}$  is 12V,  $V_{OUT}$  is 1.8V and  $I_O$  is 0–6A.

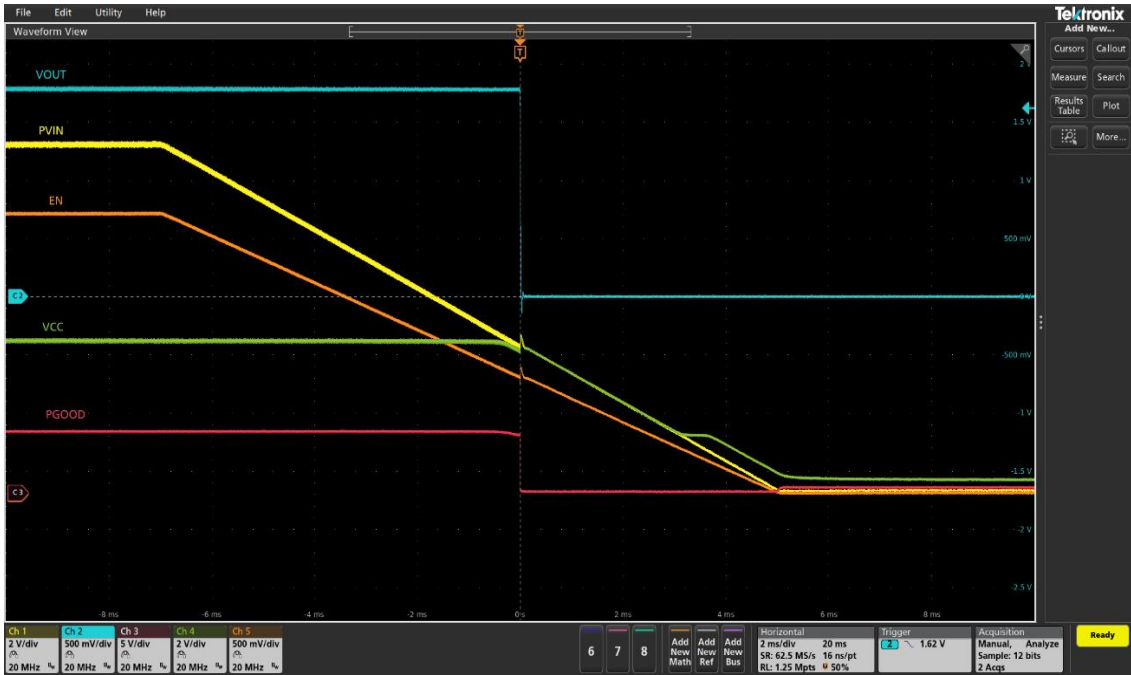


**Figure 3 Startup with no load (Ch1:  $PV_{IN}$ , Ch2:  $V_{OUT}$ , Ch3: PG, Ch4:  $V_{CC}$ , Ch5: Enable)**

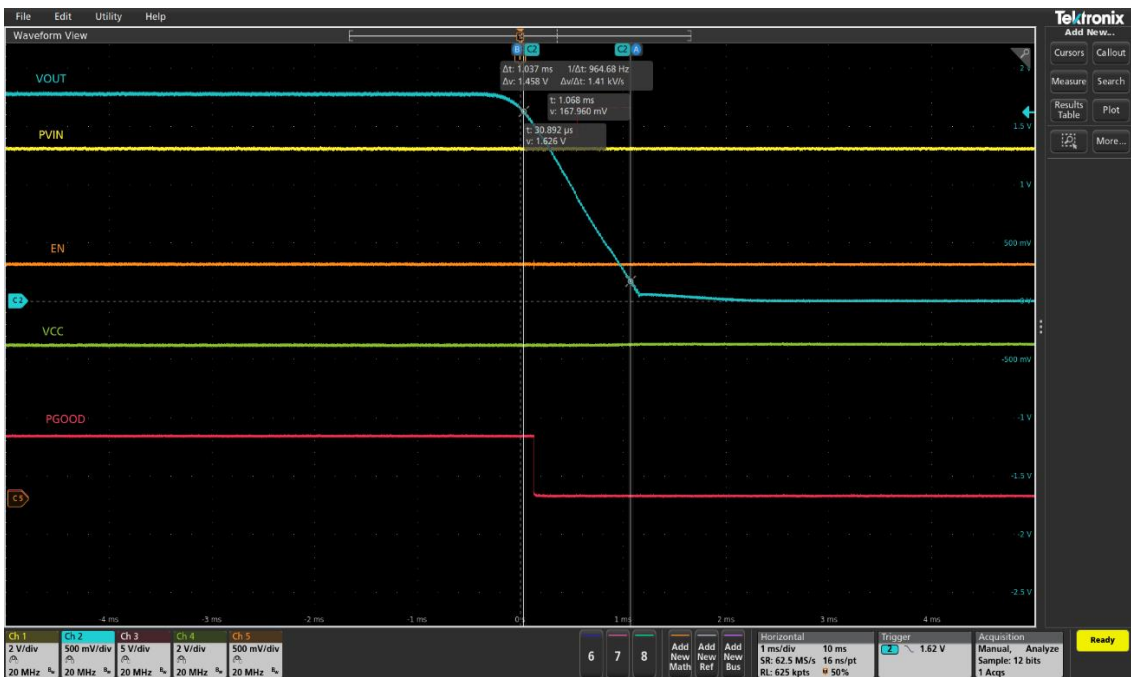


**Figure 4 Startup with 6A load (Ch1:  $PV_{IN}$ , Ch2:  $V_{OUT}$ , Ch3: PG, Ch4:  $V_{CC}$ , Ch5: Enable)**

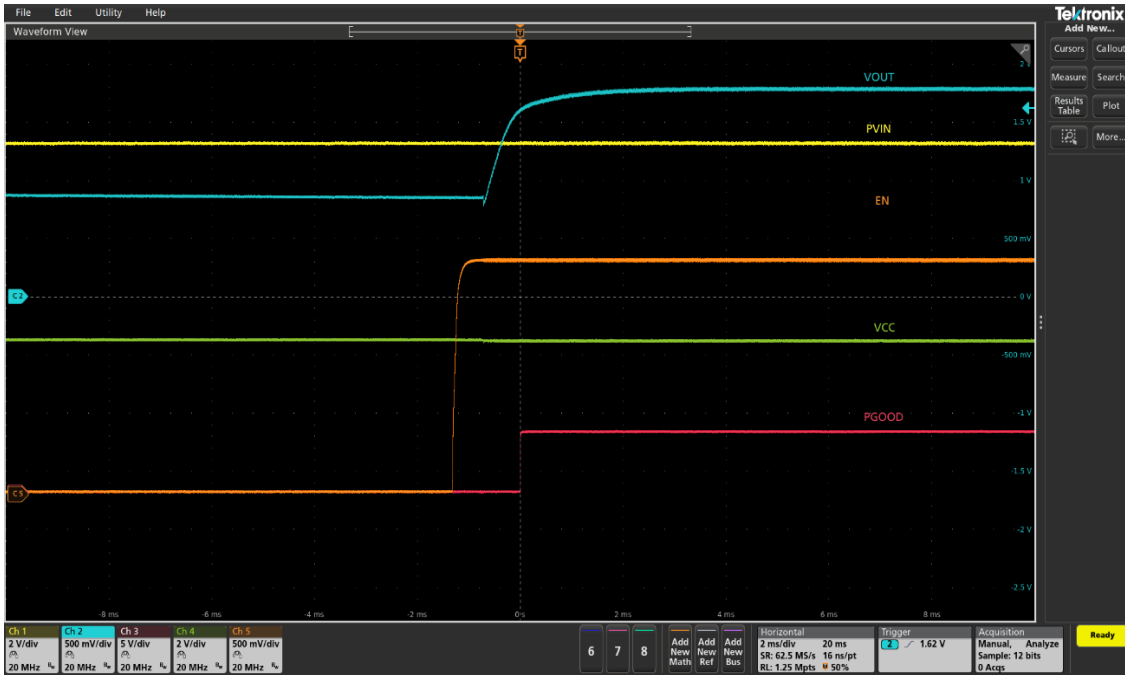




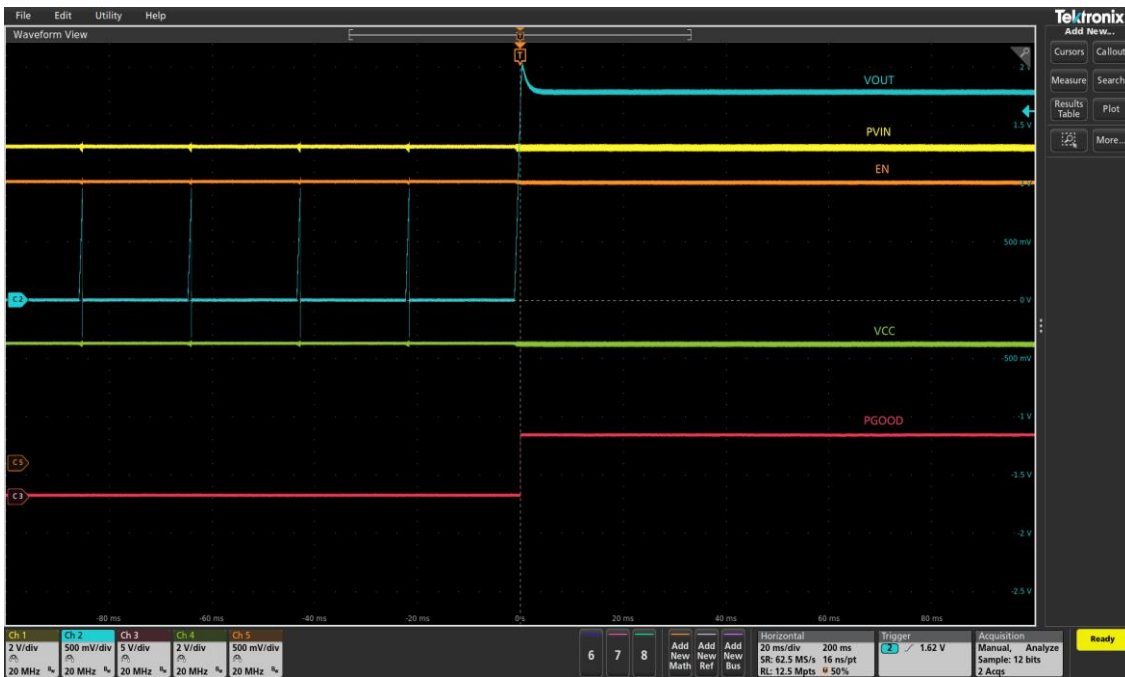
**Figure 5 Shutdown with Enable de-assertion at 6A load (Ch1:PV<sub>IN</sub>, Ch2: V<sub>OUT</sub>, Ch3: PG, Ch4:V<sub>CC</sub>, Ch5: Enable)**



**Figure 6 Soft turn off at 0A (Ch1:PV<sub>IN</sub>, Ch2: V<sub>OUT</sub>, Ch3: PG, Ch4:V<sub>CC</sub>, Ch5: Enable)**



**Figure 7 Startup into pre-bias (Ch1:PV<sub>IN</sub>, Ch2: V<sub>OUT</sub>, Ch3: PG, Ch4:V<sub>CC</sub>, Ch5: Enable)**



**Figure 8 Over-current protection and auto-recover to 6A (Ch1:PV<sub>IN</sub>, Ch2: V<sub>OUT</sub>, Ch3: PG, Ch4:V<sub>CC</sub>, Ch5: Enable)**



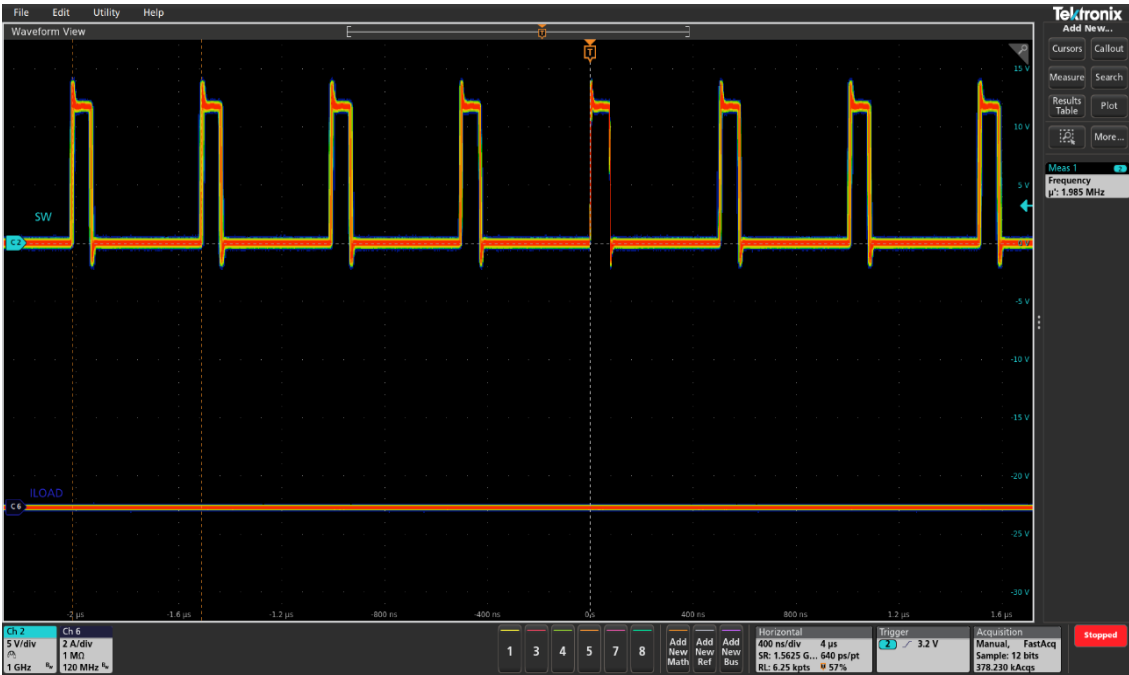


Figure 9 *Sw at 0A (Ch2: Sw, Ch6:  $I_o$ ),  $F_{sw} = 1.99\text{MHz}$*

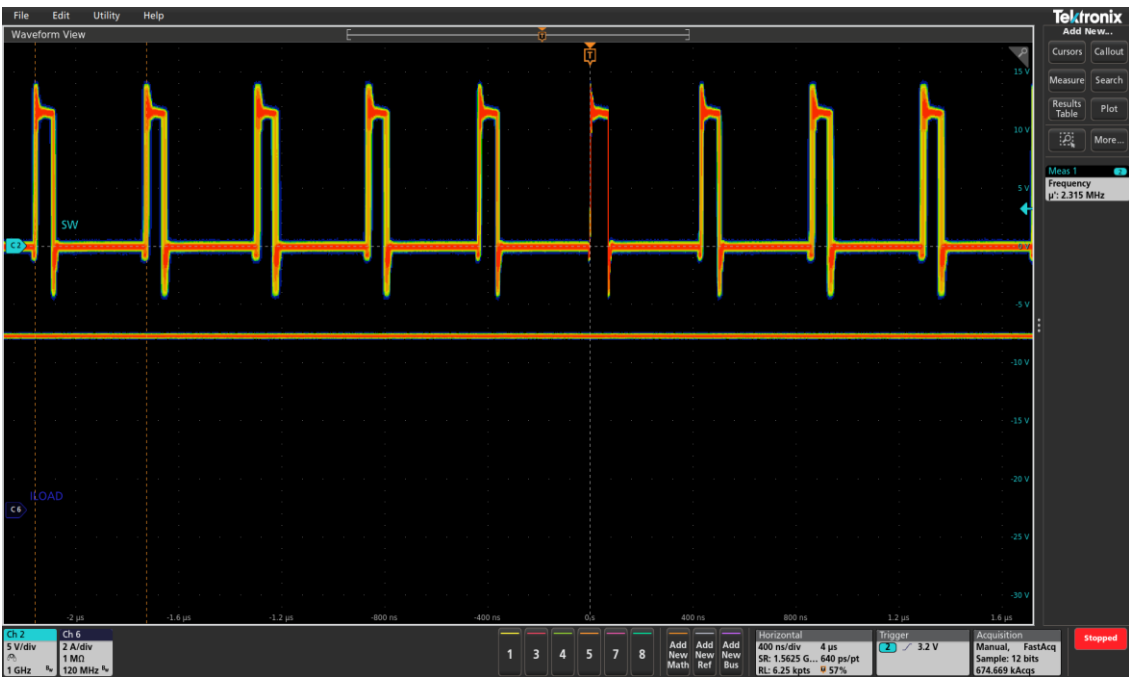
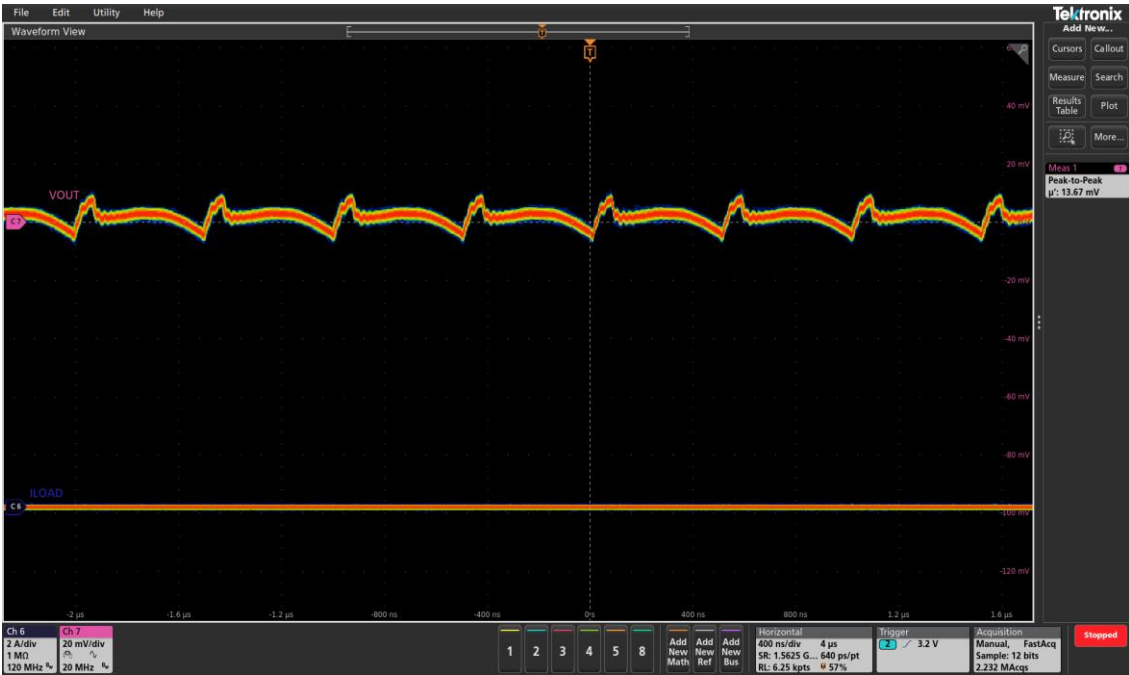
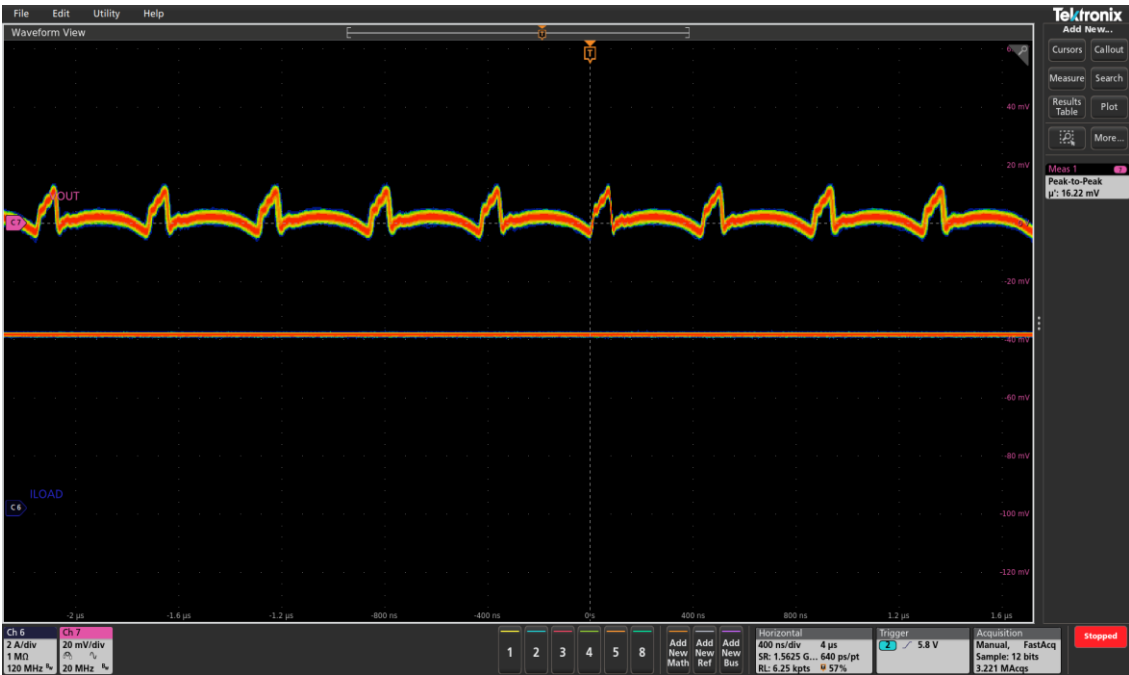


Figure 10 *Sw at 6A (Ch2: Sw, Ch6:  $I_o$ ),  $F_{sw} = 2.32\text{MHz}$*



**Figure 11**  $V_{OUT}$  ripple at 0A (Ch6:I<sub>O</sub>, Ch7:V<sub>OUT</sub>), Peak-Peak  $V_{OUT}$  ripple = 13.7mV



**Figure 12**  $V_{OUT}$  ripple at 6A (Ch6:I<sub>O</sub>, Ch7:V<sub>OUT</sub>), Peak-Peak  $V_{OUT}$  ripple = 16.2mV

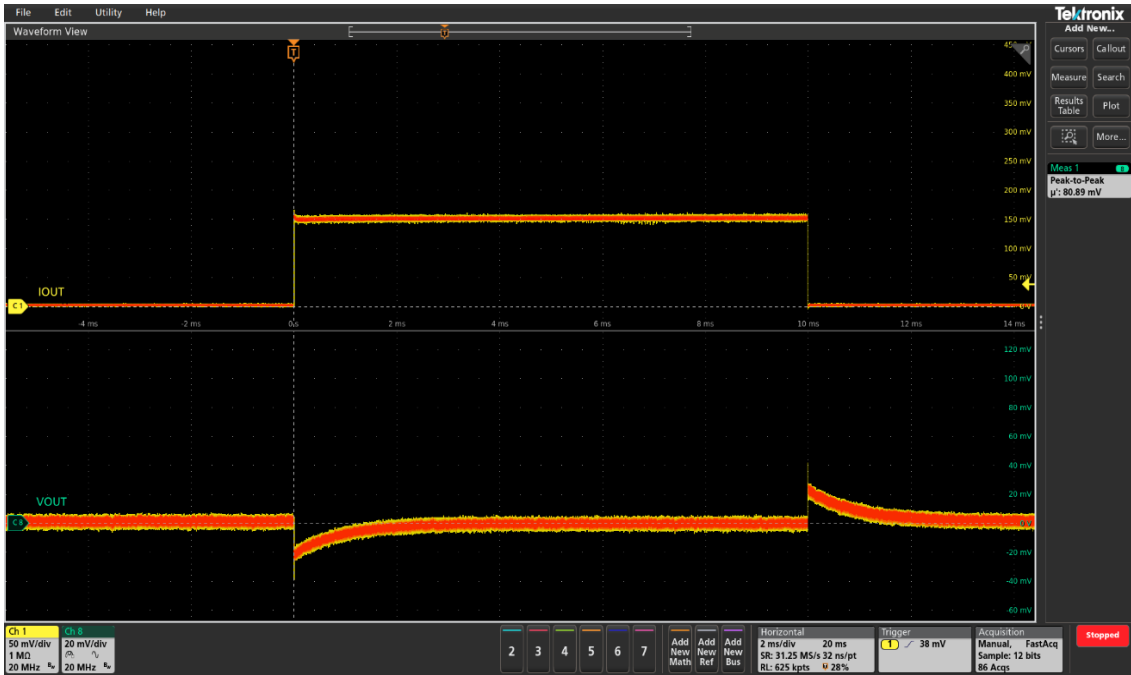


Figure 13 Transient response 0A to 3A @ 3A/us (Ch1:IO, Ch8: VOUT), peak-peak deviation = 80.9 mV

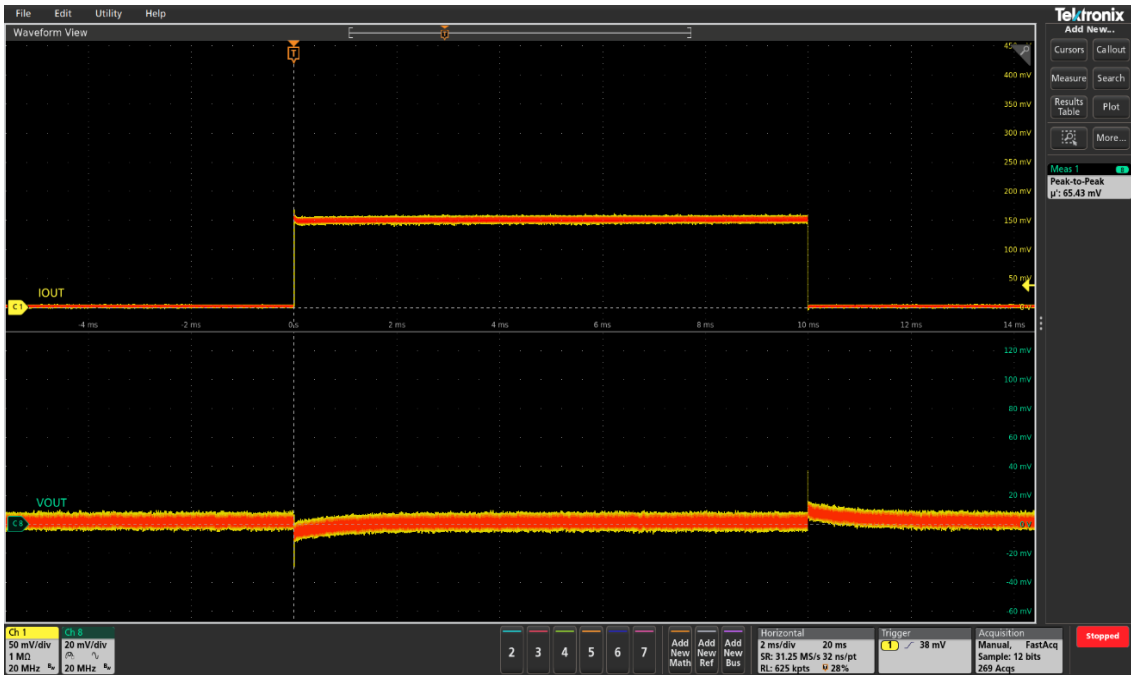
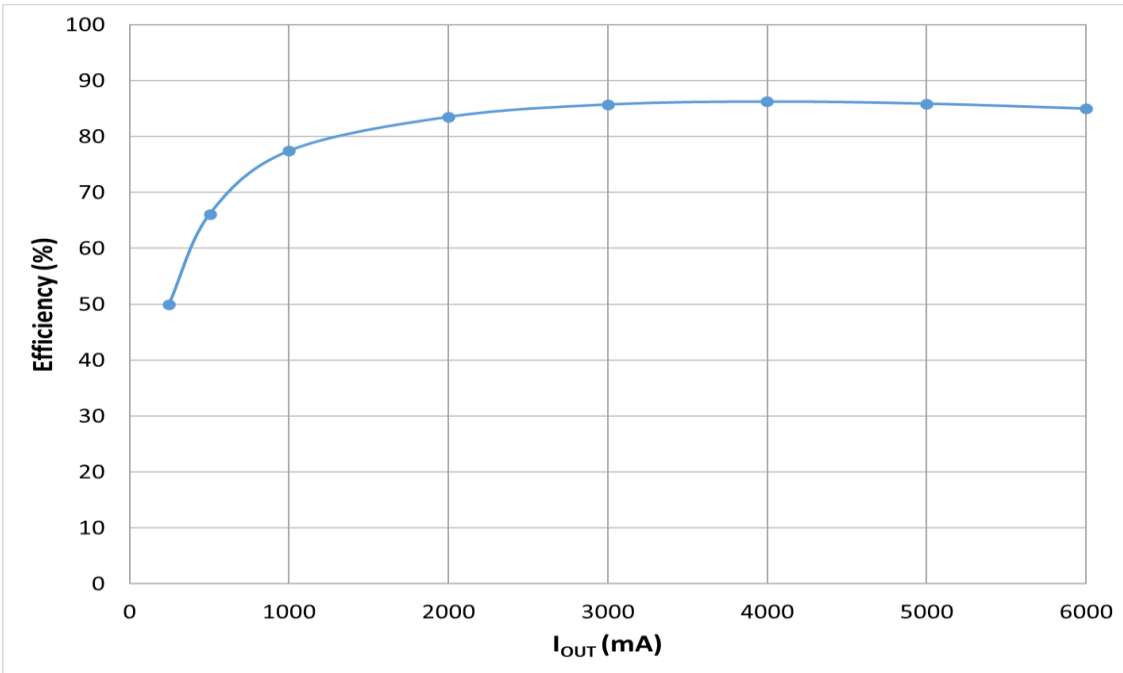
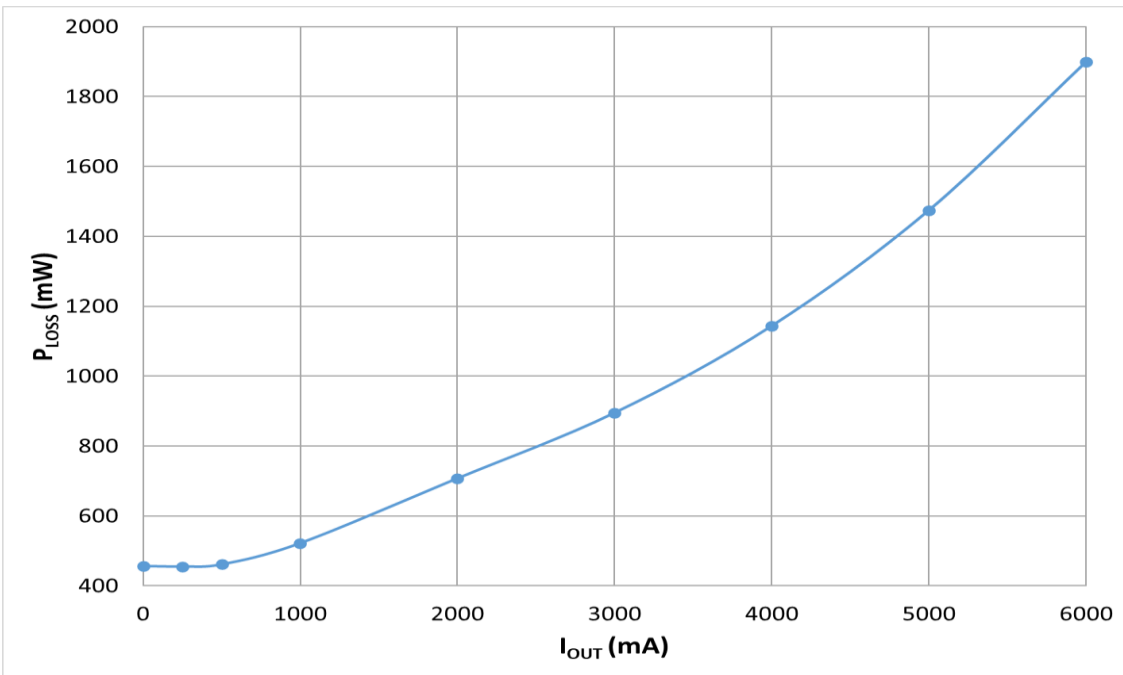


Figure 14 Transient response 3A to 6A @ 3A/us (Ch1:IO, Ch8: VOUT), peak-peak deviation = 65.4 mV



**Figure 15** Efficiency



**Figure 16** Power loss

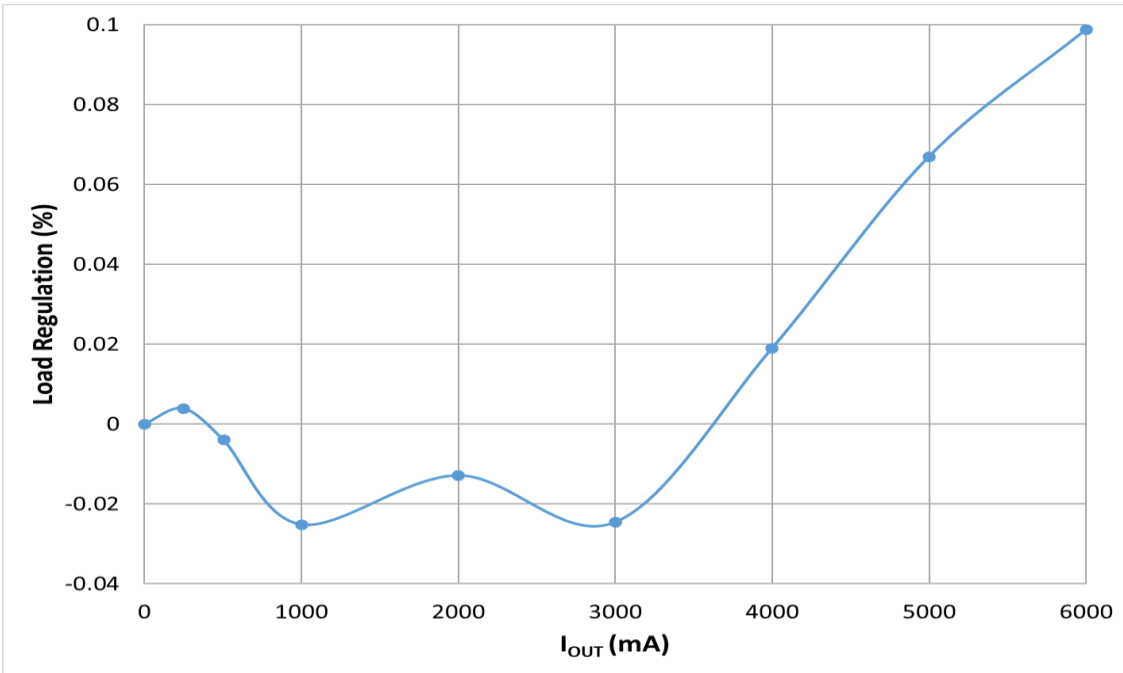


Figure 17 Load regulation – <math>\lt; \pm 0.1\% (I\_o = 0\text{--}6A)</math>

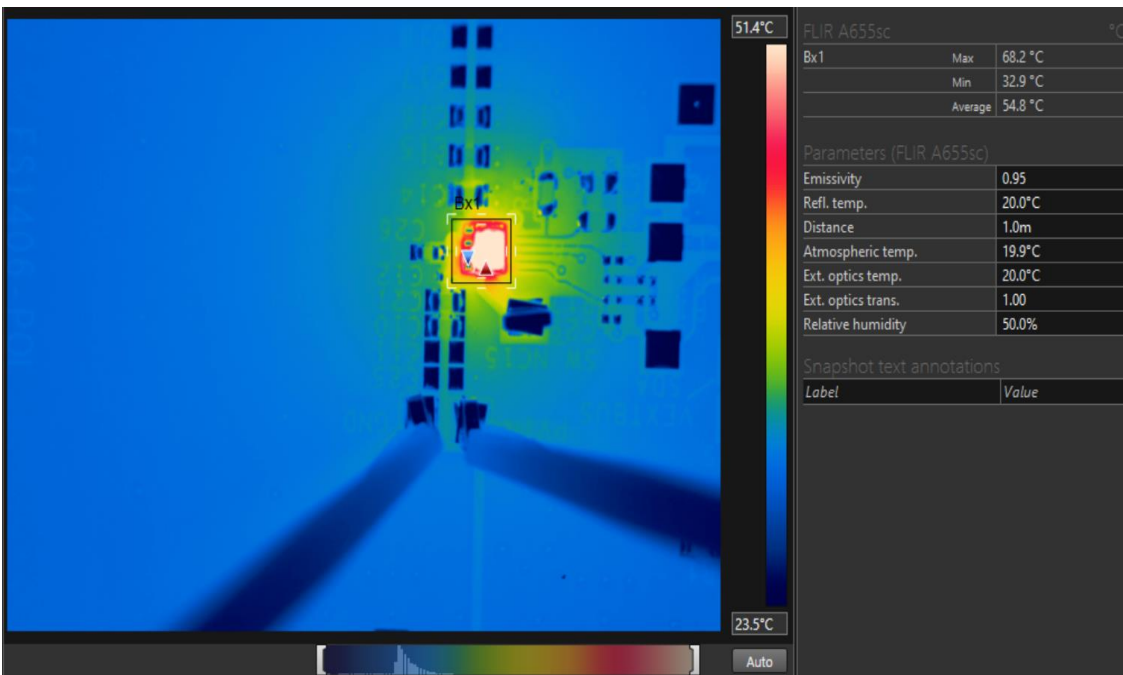


Figure 18 Thermal image(PVIN=12V, I<sub>OUT</sub>=6A) – maximum temperature rise = 45°C

## Disclaimer

### IMPORTANT NOTICE AND DISCLAIMER

TDK PROVIDES THIS POWER DESIGN USER GUIDE (“Resources”) “AS IS” AND WITH ALL FAULTS, AND DISCLAIMS. ALL WARRANTIES, EXPRESS AND IMPLIED, INCLUDING WITHOUT LIMITATION ANY IMPLIED WARRANTIES OF MERCHANTABILITY, FITNESS FOR A PARTICULAR PURPOSE OR NON-INFRINGEMENT OF THIRD PARTY INTELLECTUAL PROPERTY RIGHTS.

These Resources are intended for skilled developers designing with TDK products. You are solely responsible for (1) selecting the appropriate TDK products for your application, (2) designing, validating and testing your application, (3) ensuring your application meets applicable standards, and any other safety, security, or other requirements, and (4) ensuring your application complies with all applicable laws and regulations. These Resources are subject to change without notice and TDK assumes no responsibility for any notices or lack thereof. TDK grants you permission to use these Resources solely for development of an application that uses the TDK products described in the Resource.

This permission may be revoked at any time by TDK or any of its affiliates. Your use of these Resources shall be in compliance with all applicable laws and regulations including applicable export/import controls. Reproduction and display of these Resources is prohibited. No license is granted to any other TDK intellectual property right or to any third party intellectual property right. TDK disclaims responsibility for, and you agree to fully indemnify TDK, its affiliates and its representatives against, any claims, damages, costs, losses, and liabilities arising out of your use of these Resources.

## REMINDERS FOR USING THESE PRODUCTS

Before using these products, be sure to request the delivery specifications.

### SAFETY REMINDERS

Please pay sufficient attention to the warnings for safe designing when using these products.

The products listed on this specification sheet are intended for use in general electric equipment (AV equipment, telecommunication equipment,

### REMINDER

home appliances, amusement equipment, computer equipment, personal equipment, office equipment, measurement equipment, industrial robots) under a normal condition and use condition.

The products are not designed or warranted to meet the requirements of the applications listed below, whose performance and/or quality require a more stringent level of safety or reliability, or whose failure, malfunction or trouble could cause serious damage to sociality, person or property. Please understand that we are not responsible for any damage or liability caused by use of the products in any of the applications below or for any other use exceeding the range or conditions set forth in this specification sheet.

1. Aerospace/Aviation equipment
2. Transportation equipment (cars, electric trains, ships, etc.)
3. Medical equipment
4. Power-generation control equipment
5. Atomic energy related equipment
6. Seabed equipment
7. Transportation control equipment
8. Public Information-processing equipment
9. Military equipment
10. Electric heating apparatus, burning equipment
11. Disaster prevention/crime prevention equipment
12. Safety equipment
13. Other applications that are not considered general-purpose applications

When using this product in general-purpose application, you are kindly requested to take into consideration securing protection circuit/ equipment or providing backup circuits, etc., to ensure higher safety.

**This product is subject to a license from Power One, Inc. related to digital power technology patents owned by Power One, Inc. Power One, Inc. technology is protected by patents including:**

**AU** 3287379M 3287437AA 3290643AA 3291357AA

**CN** 10371856C 10452610C 10458656C 10459360C 10465848C 1069332A 11124619A 11346682A 1685299A 1685459A 1685582A 1685583A 1698023A 1802619A

**EP** 1561156A1 1561268A2 1576710A1 1576711A1 1604254A4 1604264A4 1714369A2 1745536A4 1769382A4 1899789A2 1984801A2

**US** 20040246754 2004090219A1 2004093533A1 2004123164A1 2004123167A1 2004178780A1 2004179382A1 20050200344 20050223252 2005209373A1 20060061214 2006015619A1 20060174145 20070226526 20070234095 20070240000 20080052551 20080072080 20080186006 6741099 6788036 6936999 6949916 7000125 7049798 7069021 7080265 7249267 7266709 7315156 7372682 7373527 7394445 7456617 7459892 7493504 7526660

**WO** 04044718A1 04045042A3 04045042C1 04062061A1 04062062A1 04070780A3 04084390A3 04084391A3 05079227A3 05081771A3 06019569A3 2007001584A3 2007094935A3